



Function

Luxor manufactures a wide range of compression fittings to fit all types of installation. This includes fittings for copper (or mild steel) pipes, polyethylene pipes (polybutene or polypropylene) and multilayer pipes (PEX-AL-PEX).

All internal surfaces are free from galvanic treatments in compliance with Italian regulation D.M. 174 on the transport of drinking water.

Technical data

Max. working pressure:	10 bar
Max. differential pressure:	1 bar
Max. working temperature:	120 °C
Working fluids:	water in compliance with UNI 8065:2019

Materials

Nut:	CW 617 N – DW UNI-EN 12165:2016
Components:	CW 614 N – DW UNI-EN 12164:2016
Gaskets:	Peroxide cured EPDM
Insulation gasket:	Polyethylene

Surface treatment

Nickel-plating (only external)

Dimensional Drawings

TR 92

Compression fitting with brass olive.
Connection G1/2 - copper and mild steel pipe.

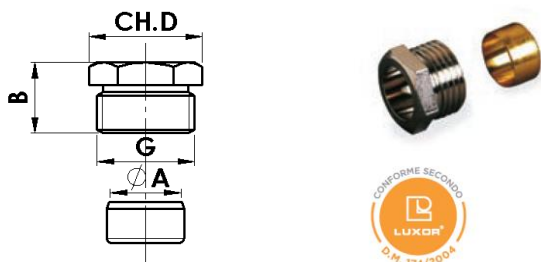

Code	Size	A	B	C	D	G
67611400	14 mm	14	15.5	-	21	G1/2
67611500	15 mm	15	15.5	-	21	G1/2

TR 94

Compression fitting with brass olive and O-ring.
Connection G1/2 - copper and mild steel pipe.



Code	Size	A	B	C	D	G
67621500	15 mm	15	14.5	-	-	G1/2

TR 91

Compression fitting with soft peroxide cured EPDM olive.
Connection W24x19 - copper pipe

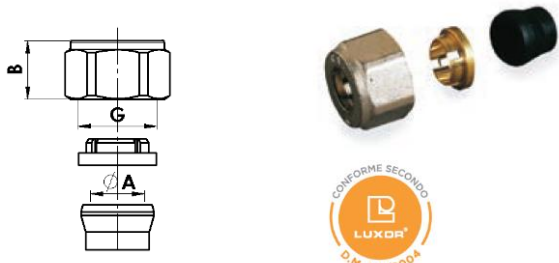

Code	Size	A	B	C	D	G
67760010	10 mm	10	16.5	-	-	W24x19
67760012	12 mm	12	16.5	-	-	W24x19
67760014	14 mm	14	16.5	-	-	W24x19
67760015	15 mm	15	16.5	-	-	W24x19
67760016	16 mm	16	16.5	-	-	W24x19

TR 91

Compression fitting with peroxide cured EPDM O-ring.
Connection W24x19 - copper pipe

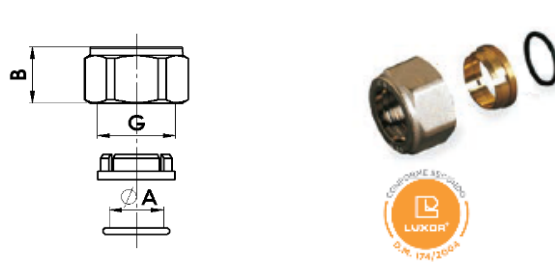

Code	Size	A	B	C	D	G
67760018	18 mm	18	16.5	-	-	W24x19

TR 91/A

Compression fitting with soft peroxide cured EPDM olive.
Connection 3/4 Eurokonus - copper pipe

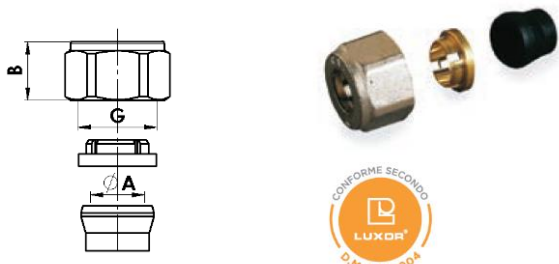

Code	Size	A	B	C	D	G
67761000	10 mm	10	18.5	-	27	G3/4Ek
67761200	12 mm	12	18.5	-	27	G3/4Ek
67761400	14 mm	14	18.5	-	27	G3/4Ek
67761500	15 mm	15	18.5	-	27	G3/4Ek
67761600	16 mm	16	18.5	-	27	G3/4Ek

TR 890

Compression fitting with soft PTFE/CV olive.

TR 91/A

Compression fitting with peroxide cured EPDM O-ring.
Connection 3/4 Eurokonus - copper pipe

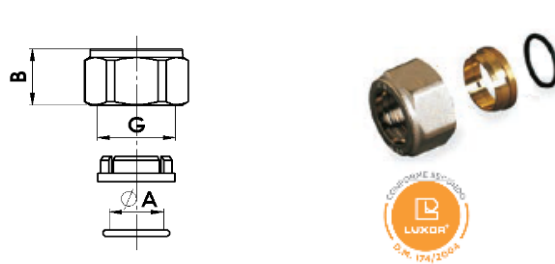

Code	Size	A	B	C	D	G
67761800	18 mm	18	18.5	-	27	G3/4Ek

TP 93

Compression fitting.

Connection G1/2 - copper pipe

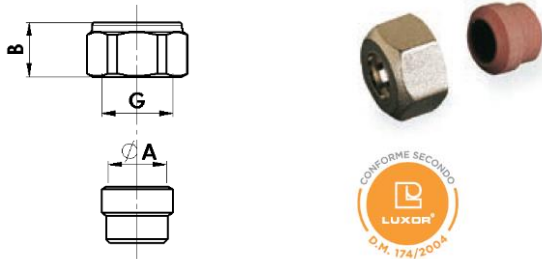

Code	Size	A	B	C	D	G
68720010	10 mm	10	14.5	-	-	G1/2
68720012	12 mm	12	14.5	-	-	G1/2
68720014	14 mm	14	14.5	-	-	G1/2
68720016	16 mm	16	14.5	-	-	G1/2

Connection G1/2 - polyethylene, polybutene and polypropylene pipe

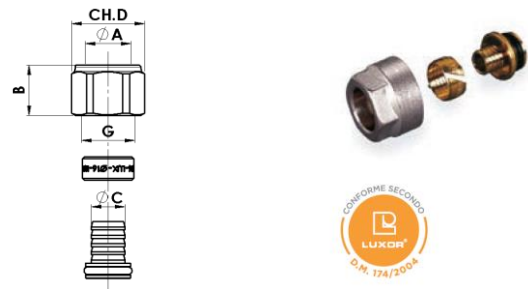

Code	Size	A	B	C	D	G
67801208	12 x 2	12	18.5	8	26	G1/2
67801510	15 x 2.5	15	18.5	10	26	G1/2
67801612	16 x 2	16	18.5	12	26	G1/2
67801616	16 x 2.2	16	18.5	11.6	26	G1/2

TP 95

Compression fitting.
Connection W24x19 - polyethylene, polybutene and polypropylene pipe

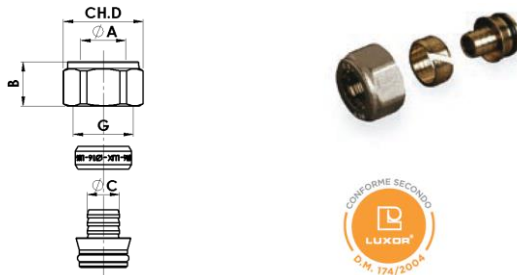

Code	Size	A	B	C	D	G
67781008	10.5 x 1.25	10.5	16.5	8	27	W24x19
67781210	12 x 1	12	16.5	10	27	W24x19
67781209	12 x 1.5	12	16.5	9	27	W24x19
67781208	12 x 2	12	16.5	8	27	W24x19
67781410	14 x 2	14	16.5	10	27	W24x19
67781511	15 x 2	15	16.5	11	27	W24x19
67781510	15 x 2.5	15	16.5	10	27	W24x19
67781613	16 x 1.5	16	16.5	13	27	W24x19
67781612	16 x 2	16	16.5	12	27	W24x19
67781616	16 x 2.2	16	16.5	11.6	27	W24x19
67781611	16 x 2.5	16	16.5	11	27	W24x19
67781628	16 x 2.8	16	16.5	10.4	27	W24x19
67781713	17 x 2	17	16.5	13	27	W24x19
67781814	18 x 2	18	16.5	14	27	W24x19
67781813	18 x 2.5	18	16.5	13	27	W24x19
67782016	20 x 2	20	20.5	16	27	W24x19
67782017	20 x 2.8	20	20.5	14.4	27	W24x19
67782034	20 x 3.4	20	20.5	13.2	27	W24x19

TP 98

Compression fitting.
Connection G3/4 Eurokonus - polyethylene, polybutene and polypropylene pipe

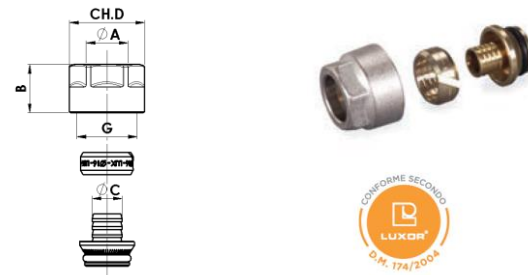

Code	Size	A	B	C	D	E
67841007	10 x 1.2	10	18.5	7.6	27	G3/4Ek
67841209	12 x 1.5	12	18.5	9	27	G3/4Ek
67841208	12 x 2	12	18.5	8	27	G3/4Ek
67841410	14 x 2	14	18.5	10	27	G3/4Ek
67841510	15 x 2.5	15	18.5	10	27	G3/4Ek
67841613	16 x 1.5	16	18.5	13	27	G3/4Ek
67841618	16 x 1.8	16	18.5	12.4	27	G3/4Ek
67841612	16 x 2	16	18.5	12	27	G3/4Ek
67841616	16 x 2.2	16	18.5	11.6	27	G3/4Ek
67841713	17 x 2	17	18.5	13	27	G3/4Ek
67841814	18 x 2	18	18.5	14	27	G3/4Ek
67842016	20 x 2	20	18.5	16	27	G3/4Ek
67842028	20 x 2.8	20	18.5	14.4	27	G3/4Ek
67842034	20 x 3.4	20	18.5	13.2	27	G3/4Ek

TP 96

Compression fitting.

Connection G1/2 - PEX-AL-PEX multilayer pipe

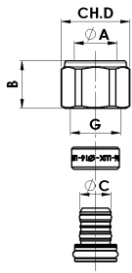

Code	Size	A	B	C	D	G
67871410	14 x 2	14	18.5	10	24	G1/2
67871612	16 x 2	16	18.5	12	24	G1/2
67871611	16 x 2.25	16	18.5	11.5	24	G1/2

TP 97

Compression fitting.

Connection W24x19 - PEX-AL-PEX multilayer pipe

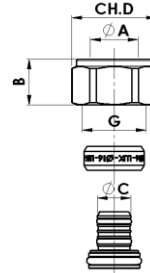

Code	Size	A	B	C	D	E
67821410	14 x 2	14	16.5	10	27	W24x19
67821612	16 x 2	16	16.5	12	27	W24x19
67821611	16 x 2.25	16	16.5	11.5	27	W24x19
67821626	16.2 x 3	16.2	16.5	10.5	27	W24x19
67821711	17 x 2.75	17	16.5	11.5	27	W24x19
67821713	17 x 2	17	16.5	13	27	W24x19
67821712	17 x 2.5	17	16.5	12	27	W24x19
67821814	18 x 2	18	16.5	14	27	W24x19
67822016	20 x 2	20	20.5	16	27	W24x19
67822017	20 x 2.25	20	20.5	15.5	27	W24x19
67822015	20 x 2.5	20	20.5	15	27	W24x19
67822014	20 x 3	20	20.5	14	27	W24x19

TP 99

Compression fitting.

Connection 3/4 Eurokonus - PEX-AL-PEX multilayer pipe

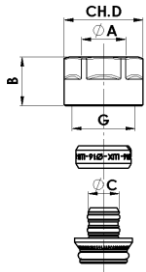

Code	Size	A	B	C	D	G
67861210	12.2 x 1.3	12.2	18.5	10	27	G3/4Ek
67861410	14 x 2	14	18.5	10	27	G3/4Ek
67861512	15 x 1.5	15	18.5	12	27	G3/4Ek
67861612	16 x 2	16	18.5	12	27	G3/4Ek
67861611	16 x 2.25	16	18.5	11.5	27	G3/4Ek
67861610	16.2 x 3	16.2	18.5	10.5	27	G3/4Ek
67861713	17 x 2	17	18.5	13	27	G3/4Ek
67861712	17 x 2.5	17	18.5	12	27	G3/4Ek
67861711	17 x 2.75	17	18.5	11.5	27	G3/4Ek
67861814	18 x 2	18	18.5	14	27	G3/4Ek
67862016	20 x 2	20	18.5	16	27	G3/4Ek
67862017	20 x 2.25	20	18.5	15.5	27	G3/4Ek
67862015	20 x 2.5	20	18.5	15	27	G3/4Ek
67862014	20 x 3	20	18.5	10.5	27	G3/4Ek

Working Instructions

To avoid inconveniences caused by an improper installation, which could be very costly, it is advisable to follow the below instructions:

- **How to prepare the pipe.**

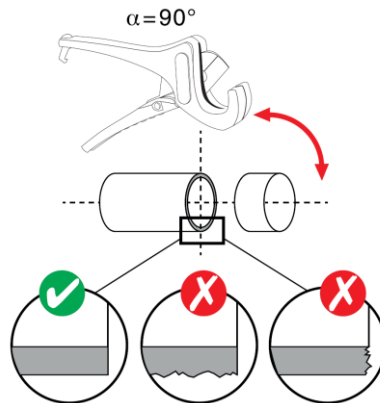

1. Cutting the pipe. For a correct cut, use suitable shears so as to avoid the ovalization of the pipe and take care that the cut is perpendicular to the pipe axis.

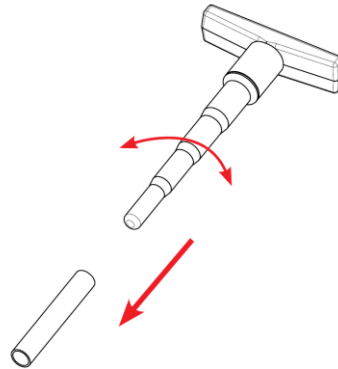

2. Calibration. This operation guarantees to obtain a correct internal diameter.

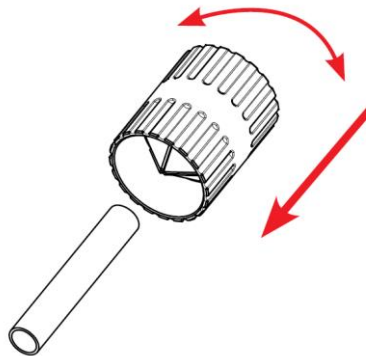

3. Flaring. This operation creates an internal chamfer which eases the insertion of the fitting in the pipe and avoids the displacement of the O-rings from their seat.

- **Correct assembly of the compression fitting**

Assemble the parts of the fitting in the same order and direction shown in the pictures.

Fittings for copper pipe

TR 91
TR 91/A

TR 92

TR 94

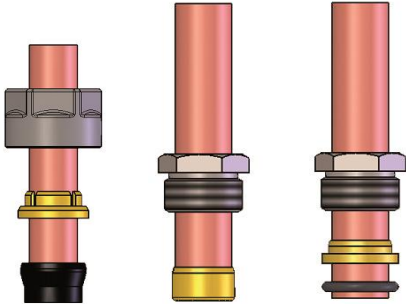

Fittings for plastic pipe

TP 93 – TP 95 – TP 98

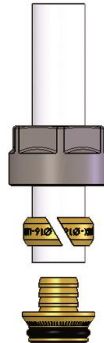

Fittings for multilayer pipe

TP 96 – TP 97 – TP 99

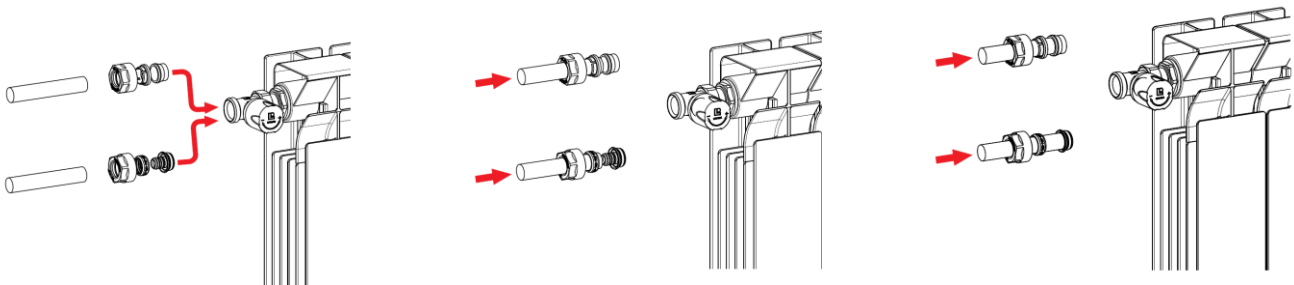
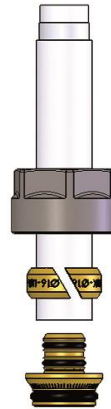

Insert the pipe with its rubber holder inside the fitting, making sure that this part is clean and avoiding to pinch the O-ring.

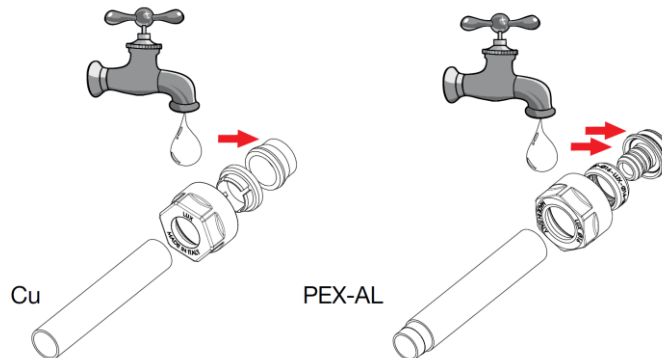

Do not lubricate the rubber parts with oil or mineral based grease: the EPDM compound is compatible only with silicone based lubricants. To avoid any possible mistake, it is advisable to lubricate these parts simply with water.

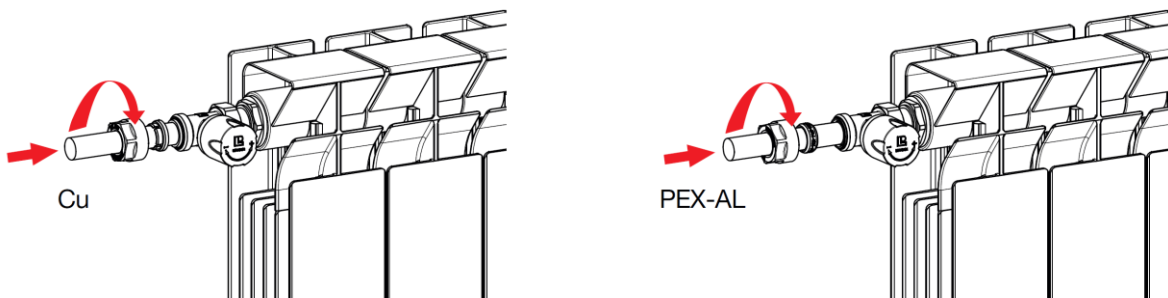

Insert the nut and screw it manually as much as possible and then with a CH 110 key.

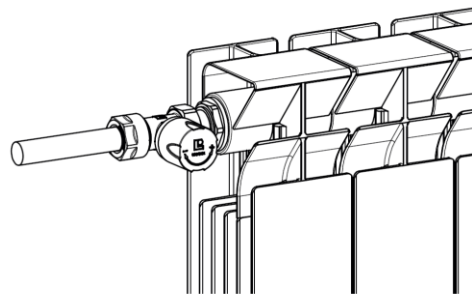
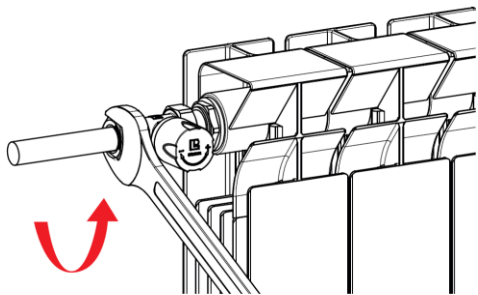

For a correct use of the fittings it is necessary to observe the below chart concerning the nuts torque according to the type of fitting and the type of pipe.

MISURA TUBO TUBE SIZE	RAME RICOTTO ANNEALED COPPER	RAME SEMIDURO SEMI-SOFT COPPER	ACCIAIO DOLCE MILD STEEL	POLIETILENE POLIPROPILENE POLIBUTENE POLYETHYLENE POLYPROPYLENE POLYBUTENE	MULTISTRATO PEX-AL-PEX MULTILAYER PEX-AL-PEX
Fino a / Up to Ø 18 mm	Da 35 a 45 Nm from 35 to 45 Nm	Da 60 a 80 Nm from 60 to 80 Nm	Da 60 a 70 Nm from 60 to 70 Nm	Da 40 a 50 Nm from 40 to 50 Nm	Da 25 a 35 Nm from 25 to 35 Nm
Oltre / Above Ø 18 mm	-	-	-	Da 40 a 50 Nm from 40 to 50 Nm	Da 25 a 35 Nm from 25 to 35 Nm

Item Specifications

TR 92

Fitting for copper or mild steel pipe for continuous high temperature use. G1/2 male thread.

TR 94

Fitting for copper or mild steel pipe for continuous high temperature use. G1/2 male thread.

TR 890

Fitting for copper pipe for continuous high temperature use. G1/2 thread.

TR 91

Fitting for copper pipe for continuous high temperature use. W24x19 thread.

TR 91/A

Fitting for copper pipe for continuous high temperature use. G3/4 Eurokonus thread.

TP 93

Fitting for polyethylene, polybutene and polypropylene pipe for continuous high temperature use. G1/2 thread.

TP 95

Fitting for polyethylene, polybutene and polypropylene pipe for continuous high temperature use. W24x19 thread.

TP 98

Fitting for polyethylene, polybutene and polypropylene pipe for continuous high temperature use. G3/4 Eurokonus thread.

TP 96

Fitting for multilayer pipe for continuous high temperature use. G1/2 thread.

TP 97

Fitting for multilayer pipe for continuous high temperature use. W24x19 thread.

TP 99

Fitting for multilayer pipe for continuous high temperature use. G3/4 Eurokonus thread.



Luxor S.p.A.

Sede amministrativa, stabilimento e uffici commerciali:

Administrative office, factory and commercial office:

Tel.: 030-9961161 – Fax: 030-9961165

info@luxor.it – www.luxor.it

via Madonnina, 94 – 25018 Montichiari - (BS) Italy

*Luxor si riserva il diritto di apportare miglioramenti e modifiche ai prodotti descritti ed ai relativi dati tecnici in qualsiasi momento e senza preavviso -
Luxor reserves the right to ameliorate and modify the above products and their technical data at any time and without notice*