



## 7 / FITTINGS

# FITTINGS

## COMPRESSION FITTINGS FOR COPPER, PLASTIC AND MULTILAYER PIPES



### TECHNICAL DATA

Max temperature	Max pressure	Nuts
120 °C	10 bar	CW617N UNI EN 12165:2016
Fittings	Gaskets OR	Gaskets
CW614N UNI EN 12164:2016	EPDM	Polyethylene

### SYSTEM CONNECTIONS



**Iron pipe**  
W 24x19 - TR 91  
G 3/4 EK - TR 91/A  
G 1/2 - TR 890  
G 1/2 - TR 94  
G 1/2 - TR 92



**Copper pipe**  
W 24x19 - TR 91  
G 3/4 EK - TR 91/A  
G 1/2 - TR 890  
G 1/2 - TR 94  
G 1/2 - TR 92



**Plastic pipe**  
W 24x19 - TP 95  
G 3/4 EK - TP 98  
G 1/2 - TP 93



**Multilayer pipe**  
W 24x19 - TP 97  
G 3/4 EK - TP 99  
G 1/2 - TP 96  
G 1/2 F - TP 90

### OPERATING INSTRUCTIONS

To avoid inconveniences caused by an improper installation, which could be very costly, it is advisable to follow the below instructions:

• **How to prepare the pipe.**

1. **Cutting the pipe.** For a correct cut, use suitable shears so as to avoid the ovalization of the pipe and take care that the cut is perpendicular to the pipe axis.

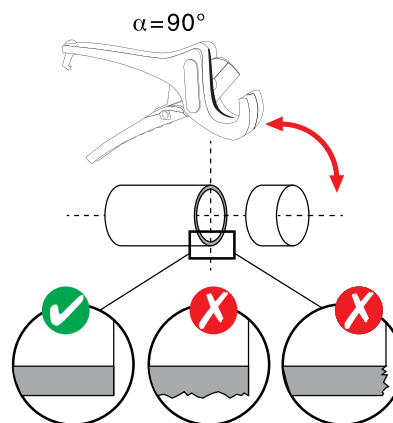

The characteristics of the fluid in the system must be compliant with the UNI 8065: 2019 directive.

**2. Calibration.** This operation guarantees to obtain a correct internal diameter.

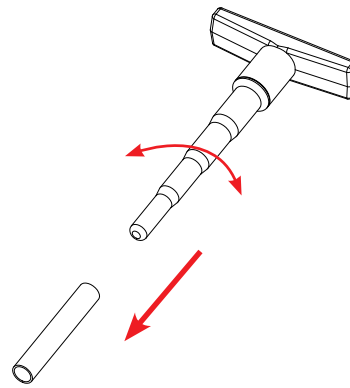

**3. Flaring.** This operation creates an internal chamfer which eases the insertion of the fitting in the pipe and avoids the displacement of the o-rings from their seat.

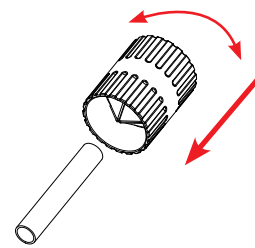

### CORRECT ASSEMBLY OF THE COMPRESSION FITTING.

Assemble the parts of the fitting in the same order and direction shown in the below pictures.

FITTINGS FOR COPPER PIPE/MILD STEEL			FITTINGS FOR PLASTIC PIPE	FITTINGS FOR MULTILAYER PIPE
TR 91 • TR 91/A	TR 92	TR 94	TP 93 • TP 95 • TP 98	TP 96 • TP 97 • TP 99
↓	↓	↓	↓	↓

Insert the pipe with its rubber holder inside the fitting, making sure that this part is clean and avoiding to pinch the o-ring.

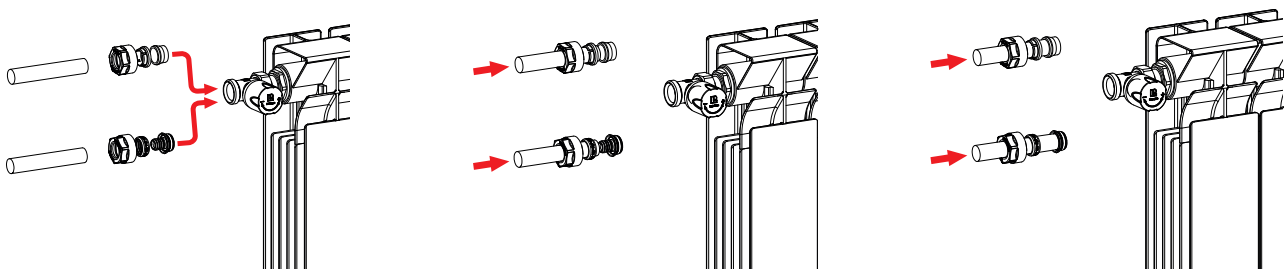

Do not lubricate the rubber parts with oil or mineral based grease: the EPDM compound is compatible only with silicone based lubricants. To avoid any possible mistake, it is advisable to lubricate these parts simply with water.

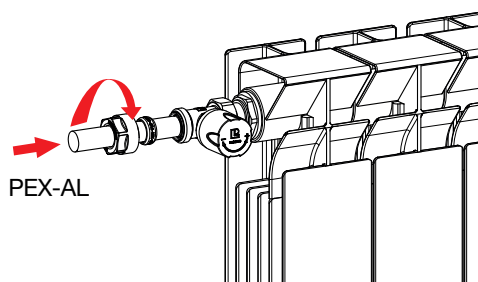
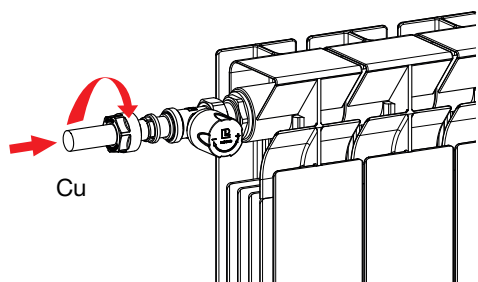
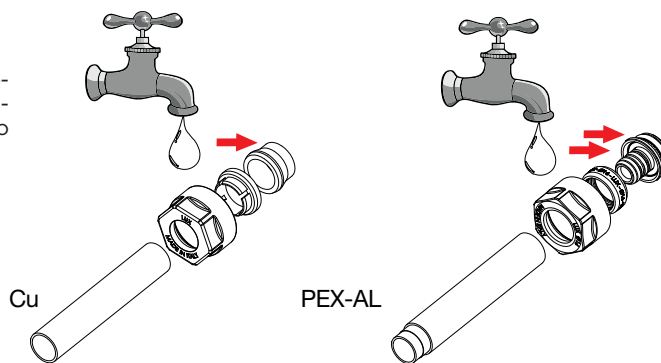

Insert the nut and screw it manually as much as possible and then with a CH 110 key.

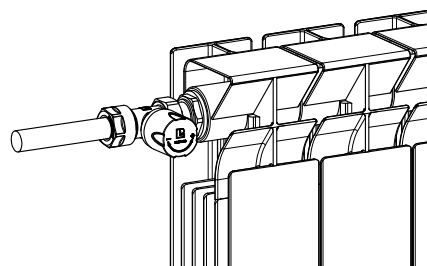
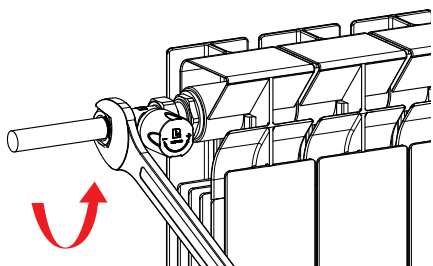

### TORQUE

For a correct use of the fittings it is necessary to observe the below chart concerning the nuts torque according to the type of fitting and the type of pipe.



TUBE SIZE	ANNEALED COPPER	SEMI-SOFT COPPER	MILD STEEL	POLYETHYLENE, POLYPROPYLENE POLYBUTENE	MULTILAYER PEX-AL-PEX
Up to Ø 18 mm	From 35 to 45 Nm	From 60 to 80 Nm	From 60 to 70 Nm	From 40 to 50 Nm	From 25 to 35 Nm
Above Ø 18 mm	-	-	-	From 40 to 50 Nm	From 25 to 35 Nm

**FITTINGS FOR COPPER PIPE**



**TR 92**

Compression fitting with brass ogive for copper or mild steel pipe. In compliance with D.M. 174/2004.

CODE	SIZE			
67611400	14 mm	24	100	800
67611500	15 mm	21	100	800

thread G1/2



**TR 94**

Compression fitting with brass ogive with o-ring for copper or mild steel pipe for underfloor installation.

CODE	SIZE			
67621500	15 mm	20	100	800

thread G1/2



**TR 890**

Soft compression fitting with PTFE/CV ogive - for copper pipe - thread G1/2.

CODE	SIZE			
68720010	10 mm	26	50	400
68720012	12 mm	25	50	400
68720014	14 mm	20	50	400
68720016	16 mm	19	50	400

thread G1/2



**TR 91**

Soft compression fitting with EPDM ogive - for copper pipe - thread W24x19.

CODE	SIZE			
67760010	10 mm	52	50	400
67760012	12 mm	44	50	400
67760014	14 mm	42	50	400
67760015	15 mm	40	50	400
67760016	16 mm	38	50	400
67760018	18 mm	36	50	400

thread W24x19



**TR 91/A**

Soft compression fitting with EPDM ogive - for copper pipe - thread G3/4 eurokonus.

CODE	SIZE			
67761000	10 mm	54	40	320
67761200	12 mm	52	40	320
67761400	14 mm	50	40	320
67761500	15 mm	50	40	320
67761600	16 mm	48	40	320
67761800	18 mm	46	40	320

thread G3/4 eurokonus



**FITTINGS FOR POLYETHYLENE, POLYBUTILENE AND POLYPROPYLENE PIPE**



**TP 93**

Compression fitting for polyethylene, polybutilene and polypropylene pipe, thread G 1/2.

CODE	SIZE			
67801208	12 x 2	56	50	400
67801510	15 x 2,5	48	50	400
67801612	16 x 2	45	50	400
67801616	16 x 2,2	44	50	400

thread G1/2

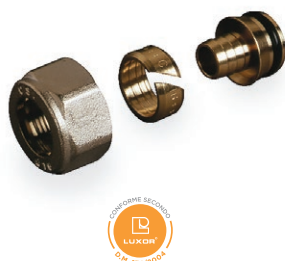

**TP 95**

Compression fitting for polyethylene, polybutilene and polypropylene pipe, thread W24x19.

CODE	SIZE			
67781008	10,5 x 1,25	62	50	400
67781210	12 x 1	52	50	400
67781209	12 x 1,5	60	50	400
67781208	12 x 2	59	50	400
67781410	14 x 2	60	50	400
67781511	15 x 2	54	50	400
67781510	15 x 2,5	56	50	400
67781613	16 x 1,5	52	50	400
67781612	16 x 2	56	50	400
67781616	16 x 2,2	56	50	400
67781611	16 x 2,5	56	50	400
67781628	16 x 2,8	56	50	400
67781713	17 x 2	50	50	400
67781814	18 x 2	48	50	400
67781813	18 x 2,5	48	50	400
67782016	20 x 2	60	50	400
67782017	20 x 2,8	68	50	400
67782034	20 x 3,4	60	50	400

thread W24x19

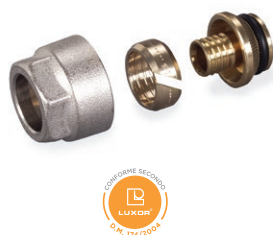

**TP 98**

Compression fitting for polyethylene, polybutilene and polypropylene pipe, thread G3/4 **eurokonus**.

CODE	SIZE			
67841007	10 x 1,2	76	40	320
67841209	12 x 1,5	76	40	320
67841208	12 x 2	76	40	320
67841410	14 x 2	70	40	320
67841510	15 x 2,5	70	40	320
67841613	16 x 1,5	60	40	320
67841618	16 x 1,8	60	40	320
67841612	16 x 2	60	40	320
67841616	16 x 2,2	68	40	320
67841713	17 x 2	58	40	320
67841814	18 x 2	68	40	320
67842016	20 x 2	57	40	320
67842028	20 x 2,8	64	40	320
67842034	20 x 3,4	60	40	320

thread G3/4 eurokonus

**FITTINGS FOR POLYETHYLENE MULTILAYERS PEX-AL-PEX PIPE**

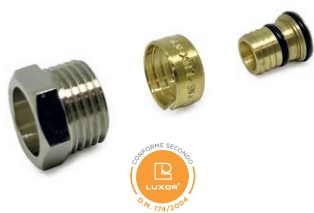

**TP 90**

Compression fitting for polyethylene multilayer pipe PEX-AL-PEX for G1/2 iron pipe connection.

CODE	SIZE			
67631612	16 x 2	27	50	400

thread G1/2

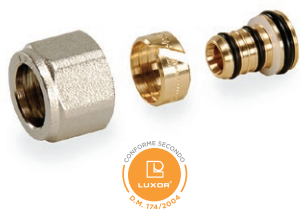

**TP 96**

Compression fitting for polyethylene multilayer pipe PEX-AL-PEX, thread G1/2.

CODE	SIZE			
67871410	14 x 2	56	50	400
67871612	16 x 2	57	50	400
67871611	16 x 2,25	52	50	400

thread G1/2



**TP 97**

Compression fitting for polyethylene multilayer pipe PEX-AL-PEX, thread W24x19.

CODE	SIZE			
67821410	14 x 2	54	50	400
67821612	16 x 2	52	50	400
67821611	16 x 2,25	52	50	400
67821626	16,2 x 3	52	50	400
67821711	17 x 2,75	49	50	400
67821713	17 x 2	50	50	400
67821712	17 x 2,5	50	50	400
67821814	18 x 2	50	50	400
67822016	20 x 2	66	50	400
67822017	20 x 2,25	64	50	400
67822015	20 x 2,5	62	50	400
67822014	20 x 3	62	50	400

thread W24x19

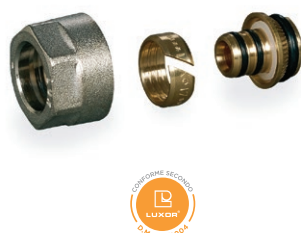

**TP 99**

Compression fitting for polyethylene multilayer pipe PEX-AL-PEX, thread G3/4 eurokonus.

CODE	SIZE			
67861210	12,2 x 1,3	74	40	320
67861410	14 x 2	78	40	320
67861512	15 x 1,5	63	40	320
67861612	16 x 2	74	40	320
67861611	16 x 2,25	74	40	320
67861610	16,2 x 3	74	40	320
67861713	17 x 2	74	40	320
67861712	17 x 2,5	74	40	320
67861711	17 x 2,75	70	40	320
67861814	18 x 2	74	40	320
67862016	20 x 2	78	40	320
67862017	20 x 2,25	76	40	320
67862015	20 x 2,5	74	40	320
67862014	20 x 3	72	40	320



thread G3/4 eurokonus

## CHROME COMPRESSION FITTINGS FOR COPPER PIPE



### TR 91/AC

Soft compression fitting with EPDM ogive - for copper pipe - thread G3/4 **eurokonus**.

CODE	SIZE			
67761000C	10 mm	57	20	240
67761200C	12 mm	54	20	240
67761400C	14 mm	51	20	240
67761500C	15 mm	48	20	240
67761600C	16 mm	46	20	240



thread G3/4 eurokonus

## CHROME-PLATED COMPRESSION FITTINGS FOR POLYETHYLENE, POLYBUTYLENE AND POLYPROPYLENE PIPE



### TP 98/C

Compression fitting for polyethylene, polybutylene and polypropylene pipe, thread G3/4 **eurokonus**.

CODE	SIZE			
67841410C	14 x 2	65	20	240
67841612C	16 x 2	61	20	240
67841713C	17 x 2	58	20	240
67841814C	18 x 2	59	20	240
67842016C	20 x 2	57	20	240



thread G3/4 eurokonus

## CHROME-PLATED COMPRESSION FITTINGS FOR POLYETHYLENE MULTILAYERS PEX-AL-PEX PIPE



### TP 99/C

Compression fitting for polyethylene multilayer pipe PEX-AL-PEX, thread G3/4 **eurokonus**.

CODE	SIZE			
67861410C	14 x 2	67	20	240
67861612C	16 x 2	65	20	240
67861611C	16 x 2.25	60	20	240
67861713C	17 x 2	60	20	240
67861814C	18 x 2	61	20	240
67862016C	20 x 2	59	20	240

thread G3/4 eurokonus



## IN-WALL CONNECTIONS FOR THE DISTRIBUTION WITH REMOVABLE PIPES

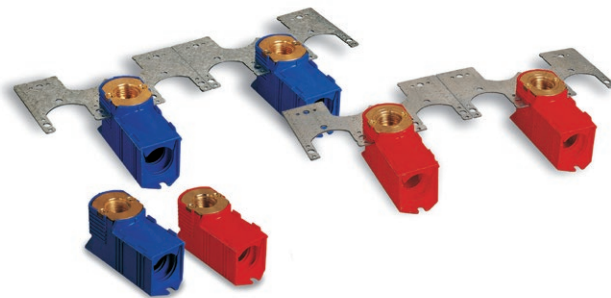

### CONSTRUCTIVE FEATURES

Luxor in-wall connections are designed to meet the modern necessity to use removable plastic pipes in heating and sanitary distribution systems.

The main features of these products are:

- easy pipe laying;
- possibility of doing maintenance without damaging the walls, working inside the plastic boxes which isolate the connections from the plaster;
- low noise of the system thanks to the absence of junctions which create noise;
- aesthetic quality of the end result.

The fittings are produced in DZR brass CW626N UNI EN 12165:2016. All gaskets are in peroxide cured EPDM. The plastic boxes containing the connections consist of talc filled polypropylene.

By using the chrome-plated copper connection pipe M 528, the tightness is guaranteed by o-rings and the aesthetic effect ensured by a chrome-plated pipe always aligned both with

### TECHNICAL DATA



Max temperature

120 °C



Max pressure

10 bar

the fitting and the wall.

The brackets SS 1982 are in galvanised iron Fe Z100 EN 10142-92 and divisible.

These items allow to lay the connections quickly and safely, at the required depth and with the correct interaxes for the connection to sanitary appliances.

All the fittings for copper and plastic pipes are supplied without assembled fittings.



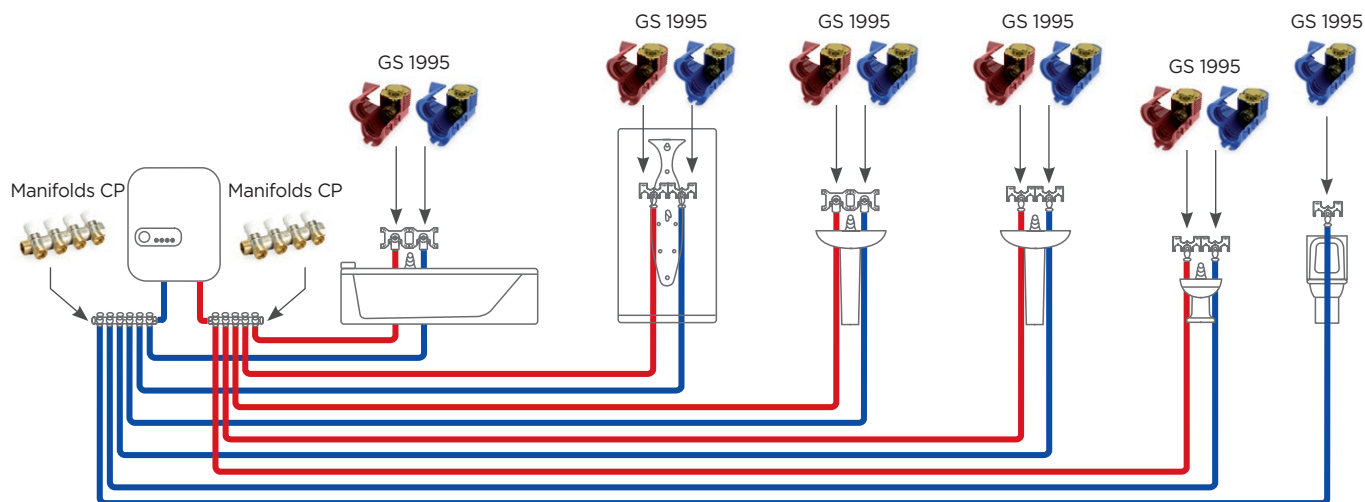

**SANITARY DISTRIBUTION SYSTEM WITH ONE INLET FOR EACH USER POINT**

This is the most common type of system, each user point is directly connected to one outlet of the distribution manifold.

The **advantages** of this type of system are:

- constant pressure for each user point;
- possibility to adjust the flow rate for each single user point;
- easy maintenance.

The **disadvantages** are:

- a very large quantity of pipes used;
- large distribution boxes.

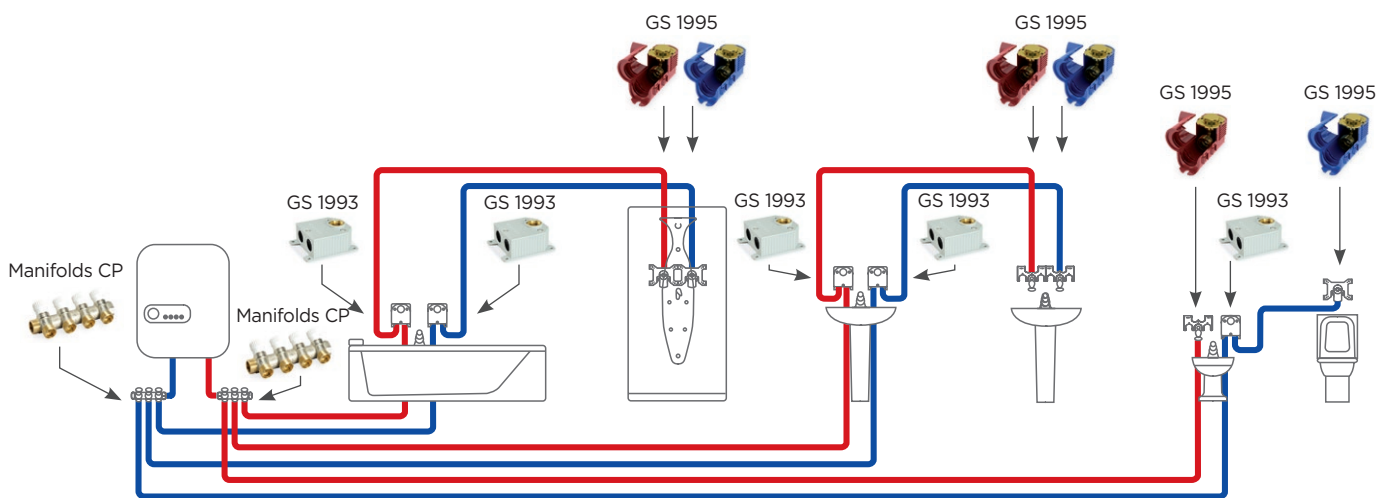

**BLOCK SANITARY DISTRIBUTION SYSTEM**

In this type of system, the user point are divided in groups.

The **advantages** are:

- low implementation costs;
- less space occupied by pipes and distribution box.

The **disadvantages** are:

- in case of simultaneous use, the flow is subdivided among the user points.

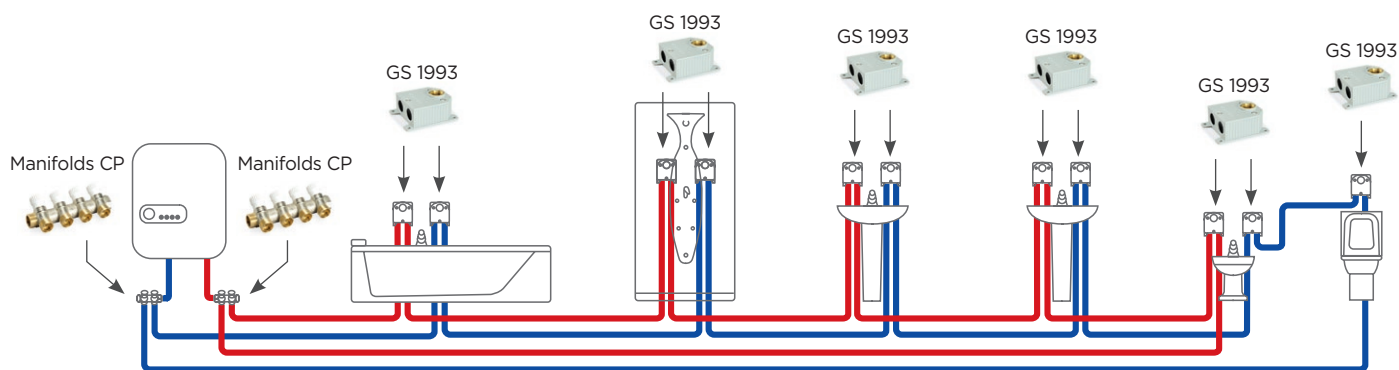

**SINGLE-PIPE SYSTEM FOR SANITARY DISTRIBUTION**

This type of system is the simplest.

The **advantages** of this type of system are:

- ease of construction;
- minimum space for pipes and distribution box;
- low construction cost.

The **disadvantages** are:

- in case of simultaneous use, the flow is subdivided among the user points.

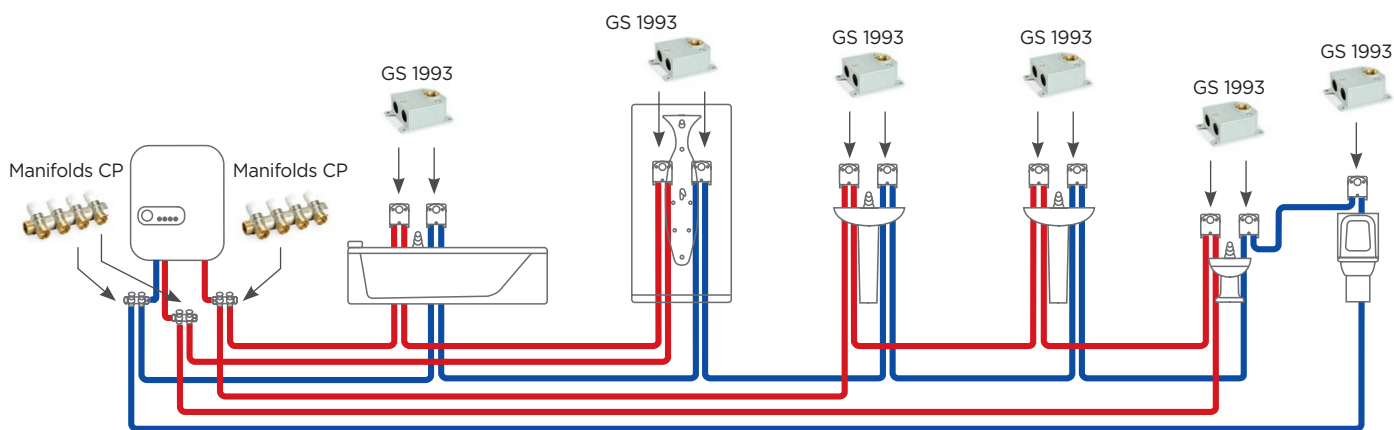

**SANITARY DISTRIBUTION SYSTEM WITH COMFORT RECIRCULATION**

This type of system creates a recirculation for hot water.

The **advantages** of such a system are:

- maximum comfort, since the hot water is immediately available, no matter the distance from the boiler.

The **disadvantages** are:

- high implementation costs;
- use of insulated pipes to reduce the heat loss;
- need to create a specific recirculation circuit.

IN-WALL CONNECTIONS FOR THE DISTRIBUTION WITH REMOVABLE PIPES

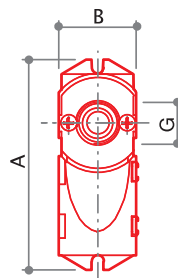
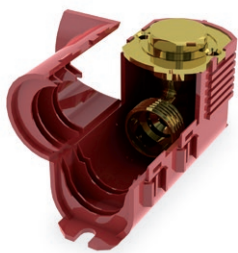

**GS 1995**

90° in-wall single elbow fitting, blue or red, without bracket, with brass cap and o-ring for tightness testing.

Fittings

CODE	SIZE	A	B	C	D	E	F	G	H	L			
66004100B	G 1/2 x (W24x19)	104	38	50	-	-	W24x19	G 1/2	-	-	124	8	64
66004100R	G 1/2 x (W24x19)	104	38	50	-	-	W24x19	G 1/2	-	-	124	8	64
66004102B*	G 1/2 x G 3/4 EK	104	38	50	-	-	G 3/4 EK	G 1/2	-	-	127	8	64
66004102R*	G 1/2 x G 3/4 EK	104	38	50	-	-	G 3/4 EK	G 1/2	-	-	127	8	64



**RC 914**

90° in-wall elbow fitting.

CODE	SIZE	FINISHING						
68549899	G 1/2 x (W24x19)	YELLOW SURFACE	TR 91	TP 95	TP 97	75	30	240
68549901	G 1/2 x G 3/4 EK	YELLOW SURFACE	TR 91/A	TP 98	TP 99	78	30	240
68549899N	G 1/2 x (W24x19)	NICKEL-PLATED	TR 91	TP 95	TP 97	75	30	240
68549901N	G 1/2 x G 3/4 EK	NICKEL-PLATED	TR 91/A	TP 98	TP 99	78	30	240

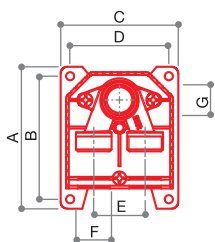

**GS 1993**

Double connection, single pipe system, with in-wall housing.

Fittings

CODE	SIZE	A	B	C	D	E	F	G	H	L			
66002200	G 1/2 x (W24x19)	105	91	87	73	38	W24x19	G 1/2	-	-	288	6	48
66002201*	G 1/2 x G 3/4 EK	105	91	87	73	38	G 3/4 EK	G 1/2	-	-	294	6	48

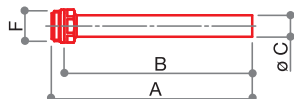

**M 528**

Chrome-plated copper connection pipe with soft seal for in-wall distribution boxes.

CODE	SIZE	A	B	C	D	E	F	G	H	L			
67510015	G 1/2 x (Ø 15 x 140)	140	131	15	-	-	G 1/2	-	-	-	70	35	280
67520015	G 1/2 x (Ø 15 x 175)	175	166	15	-	-	G 1/2	-	-	-	80	30	240

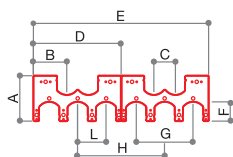

**SS 1982**

Double bracket, divisible into two single brackets, for in-wall connections GS 1995, GS 1996, interaxis 38-50-100-153.

CODE	SIZE	A	B	C	D	E	F	G	H	L			
66004000	-	80	58	38	154	308	34	100	153	50	142	25	150

## FITTINGS FOR COPPER, PLASTIC AND MULTILAYER PIPE

### TECHNICAL DATA



Max temperature

120 °C



Max pressure

10 bar



### CONSTRUCTIVE FEATURES

Luxor fittings come in raw (yellow) or nickel plated brass of the following types:

- dezincification resistant CW626N UNI EN 12165:2016
- with limited lead content as prescribed by current standards: CW617N UNI EN 12165:2016.

O-rings and gaskets are in peroxide cured EPDM.

The bracket SS 1984 consists of galvanised iron Fe Z100 EN 10142-92.

This item allows for a quick and safe installation of the fittings with the correct interaxes.

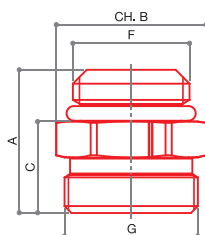

### RD 900

Straight fitting with o-ring for connection to distribution manifolds series CD.

Fittings

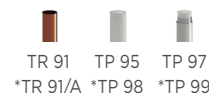

CODE	SIZE	A	B	C	D	E	F	G	H	L	FINISHING			
68559824	G 1/2 x (W24x19)	26	24	16.5	-	-	G 1/2	W24x19	-	-	YELLOW SURFACE	42	50	400
68552700*	G 1/2 x G 3/4 EK	26	27	17	-	-	G 1/2	G 3/4 EK	-	-	YELLOW SURFACE	51	50	400
68559817N**	G 3/8 x (W24x19)	24	24	15	-	-	G 3/8	W24x19	-	-	NICKEL-PLATED	36	100	800
68559824N	G 1/2 x (W24x19)	26	24	16.5	-	-	G 1/2	W24x19	-	-	NICKEL-PLATED	42	50	400
68552700N*	G 1/2 x G 3/4 EK	26	27	17	-	-	G 1/2	G 3/4 EK	-	-	NICKEL-PLATED	51	50	400

\*\* Discontinued article

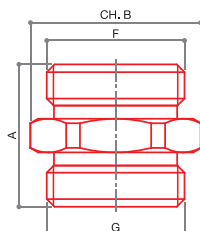

### RD 902

Straight fitting M-M.

Fittings

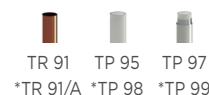

CODE	SIZE	A	B	C	D	E	F	G	H	L			
68549824N	G 1/2 x (W24x19)	32.5	24	-	-	-	R 1/2	W24x19	-	-	46	50	400
68549827N	G 3/4 x (W24x19)	27	27	-	-	-	G 3/4 EK	W24x19	-	-	46	50	400
68559822N	(W24x19) x (W24x19)	26.5	24	-	-	-	W24x19	W24x19	-	-	42	50	400
68559823N*	G 3/4 EK x G 3/4 EK	27.5	30	-	-	-	G 3/4 EK	G 3/4 EK	-	-	62	50	400



Fittings for copper pipe



Fittings for plastic pipe



Fittings for multilayer pipe

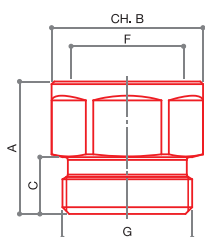

**RD 903**  
Straight fitting F-M.

Fittings

CODE	SIZE	A	B	C	D	E	F	G	H	L			
68549838N	G 1/2 x (W24x19)	24.5	25	10.5	-	-	G 1/2	W24x19	-	-	42	50	400
68549739N*	G 1/2 x G 3/4 EK	26	27	10.5	-	-	G 1/2	G 3/4 EK	-	-	60	50	400
68549743N*	G 3/4 x G 3/4 EK	25	30	10.5	-	-	G 3/4	G 3/4 EK	-	-	51	50	400
68549740N	G 3/4 x (W24x19)	25	31	10.5	-	-	G 3/4	W24x19	-	-	58	50	400
68549741N	(W24x19) x (W24x19)	25	27	10	-	-	W24x19	W24x19	-	-	48	50	400
68549742N**	(W24x19) x G 1/2	24	27	10	-	-	W24x19	G 1/2	-	-	40	50	400

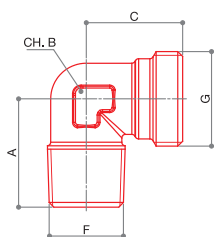

**RC 904**  
Elbow fitting M-M.

Fittings

CODE	SIZE	A	B	C	D	E	F	G	H	L			
68549847N	G 1/2 x (W24x19)	30	20	27	-	-	R 1/2	W24x19	-	-	64	50	400
68549746N*	G 1/2 x G 3/4 EK	30	20	27	-	-	R 1/2	G 3/4 EK	-	-	70	30	240

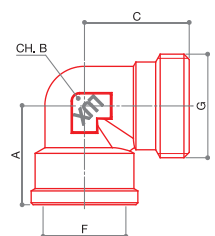

**RC 905**  
Elbow fitting F-M.

Fittings

CODE	SIZE	A	B	C	D	E	F	G	H	L			
68549856N	G 1/2 x (W24x19)	25	20	26.5	-	-	G 1/2	W24x19	-	-	79	50	400
68549755N*	G 1/2 x G 3/4 EK	25	20	26.5	-	-	G 1/2	G 3/4 EK	-	-	76	30	240
68549757N*	G 3/4 x G 3/4 EK	36.5	25	33	-	-	G 3/4	G 3/4 EK	-	-	148	25	200

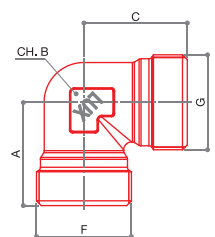

**RC 906**  
Elbow fitting M-M.

Fittings

CODE	SIZE	A	B	C	D	E	F	G	H	L			
68549865N	(W24x19) x (W24x19)	26	20	26	-	-	W24x19	W24x19	-	-	62	50	400
68549747N*	G 3/4 EK x G 3/4 EK	33	25	33	-	-	G 3/4 EK	G 3/4 EK	-	-	145	25	200

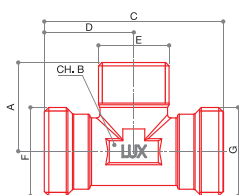

**RT 907**

T fitting MxMxM.

Fittings

- TR 91
- TP 95
- TP 97
- \*TR 91/A
- \*TP 98
- \*TP 99

CODE	SIZE	A	B	C	D	E	F	G	H	L			
68549870N	G 1/2 x (W24x19) x (W24x19)	30	20	53	26.5	G 1/2	W24x19	W24x19	-	-	82	30	240
68549770N*	G 1/2 x G 3/4 EK x G 3/4 EK	27	20	53	26.5	G 1/2	G 3/4 EK	G 3/4 EK	-	-	86	25	200

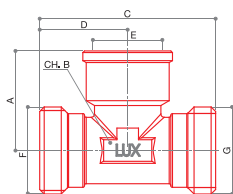

**RT 908**

T fitting FxMxM.

Fittings

- TR 91
- TP 95
- TP 97
- \*TR 91/A
- \*TP 98
- \*TP 99

CODE	SIZE	A	B	C	D	E	F	G	H	L			
68549879N	G 1/2 x (W24x19) x (W24x19)	30	20	53	26.5	G 1/2	W24x19	W24x19	-	-	98	30	240
68549779N*	G 1/2 x G 3/4 EK x G 3/4 EK	30	20	53	26.5	G 1/2	G 3/4 EK	G 3/4 EK	-	-	96	25	200

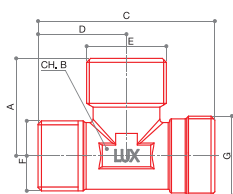

**RT 909**

T fitting with 1/2 M connection.

Fittings

- TR 91
- TP 95
- TP 97

CODE	SIZE	A	B	C	D	E	F	G	H	L			
68549888N	(W24x19) x G 1/2 x (W24x19)	29.5	20	53	26.5	W24x19	G 1/2	W24x19	-	-	100	30	240

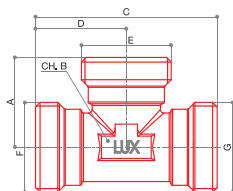

**RT 911**

T fitting.

Fittings

- TR 91
- TP 95
- TP 97
- \*TR 91/A
- \*TP 98
- \*TP 99

CODE	SIZE	A	B	C	D	E	F	G	H	L			
68549890N	(W24x19) x (W24x19) x (W24x19)	26.5	20	53	26.5	W24x19	W24x19	W24x19	-	-	78	30	240
68549790N*	G 3/4 EK x G 3/4 EK x G 3/4 EK	26.5	20	53	26.5	G 3/4 EK	G 3/4 EK	G 3/4 EK	-	-	96	25	200



Fittings for copper pipe



Fittings for plastic pipe



Fittings for multilayer pipe



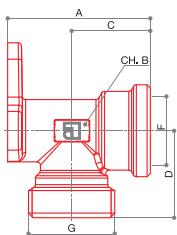

**RC 912**

Wall elbow fitting with flange.

Fittings



CODE	SIZE	A	B	C	D	E	F	G	H	L			
69549895N	G 1/2 x (W24x19)	43	19	24	26.5	-	G 1/2	W24x19	-	-	109	30	240
69549795N*	G 1/2 x G 3/4 EK	43.5	19	24	26.5	-	G 1/2	G 3/4 EK	-	-	100	25	200
69549794N*	G 3/4 x G 3/4 EK	57	21	37	27	-	G 3/4	G 3/4 EK	-	-	138	20	160

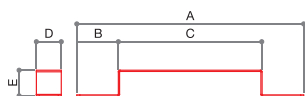

**SS 1984**

Bracket for wall fitting with flange art. RC 912 and RM.

CODE	SIZE	A	B	C	D	E	F	G	H	L			
66001200	-	382	70	242	42	43.5	-	-	-	-	280	-	50



**RD 923**

Straight fitting with male connection and fixed rubber holder for multilayer pipe.

CODE	SIZE			
69549925N	G 3/4 x 25 x 2,5	170	15	120
69549926N	G 3/4 x 26 x 3	172	15	120
69549927N	G 1" x 32 x 3	255	12	96



**RC 480**

3-piece elbow fitting with o-ring.

CODE	SIZE	FINISHING			
67952100	G 1/2	YELLOW SURFACE	128	25	200
67952700	G 3/4	YELLOW SURFACE	212	15	120
67953400	G 1"	YELLOW SURFACE	372	8	64
67952100N	G 1/2	NICKEL-PLATED	128	25	200
67952700N	G 3/4	NICKEL-PLATED	212	15	120
67953400N	G 1"	NICKEL-PLATED	372	8	64





**RD 482**

3-piece straight fitting with o-ring.

CODE	SIZE	FINISHING			
67972100	G 1/2	YELLOW SURFACE	105	30	240
67972700	G 3/4	YELLOW SURFACE	175	15	120
67973400	G 1"	YELLOW SURFACE	303	12	96
67972100N	G 1/2	NICKEL-PLATED	105	30	240
67972700N	G 3/4	NICKEL-PLATED	175	15	120
67973400N	G 1"	NICKEL-PLATED	303	12	96



**RC 481**

Nickel-plated 3-piece elbow fitting with double o-ring.

CODE	SIZE			
67952101N	G 1/2	128	20	160
67952701N	G 3/4	212	12	96
67953401N	G 1"	372	6	48



**RD 483**

Nickel-plated 3-piece straight fitting with double o-ring.

CODE	SIZE			
67972101N	G 1/2	106	25	200
67972701N	G 3/4	162	12	96
67973401N	G 1"	256	10	80



**CH 110**

Wrench key for compression fittings.

CODE	SIZE			
67822724	CH 24-27 mm	352	10	80

