



7 / TRAPS

TRAPS



CONSTRUCTIVE FEATURES

Luxor's traps offer the quality and the guarantee of a Made in Italy product. The range of items, highly appreciated by the installers for their solidity and long last performance, includes the type of traps commonly used for the washbasin, bidet and washing machine water outlet.

Some of the items we are presenting are in compliance to the UNI EN274 rule and particularly are in compliance to the dimensional requirement concerning the water column which must be not less than 50 mm.

CHROME PLATED FINISH

The entire range is produced with frame chrome plating finish, which guarantees a thicker cover and consequently a higher resistance to ageing and corrosion, next to a top level aesthetic finish.

This process is carried out employing material and galvanic processes in compliance to the most severe international rules regulating health and environmental safety.

The forged bodies of the traps are produced employing brass CW617N with low lead content in compliance to the recent rule UNI EN 12165 which regulate the chemical composition.

The trap produced from brass bar are with brass CW508L in compliance to the rule UNI EN12449. In our range of products we also have available traps in chromed ABS with excellent surface hardness, chemical resistance to external agents and shockproof.

The wall cover, polished and chromed, are both in AISI 430 and also in brass and are weatherproof and resisting to the oxidation which could occur during the normal use.





TRAPS

7.1 / ST SERIES

ST SERIES

STANDARD TRAPS

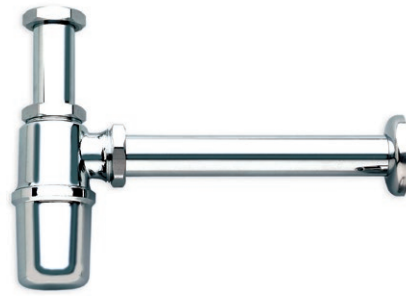

Luxor's traps offer the quality and the guarantee of a Made in Italy product.

The range of items, highly appreciated by the installers for their solidity and long last performance, includes the type of traps commonly used for the washbasin, bidet.

TECHNICAL DATA



Body material

CW 617 N - DW UNI-EN 12165:2016



Wall cover material

AISI 430



Shank and sleeve material

CW 508L



Finish

Chrome

FIELDS OF APPLICATION



washbasins



kitchen
washbasins



bidet

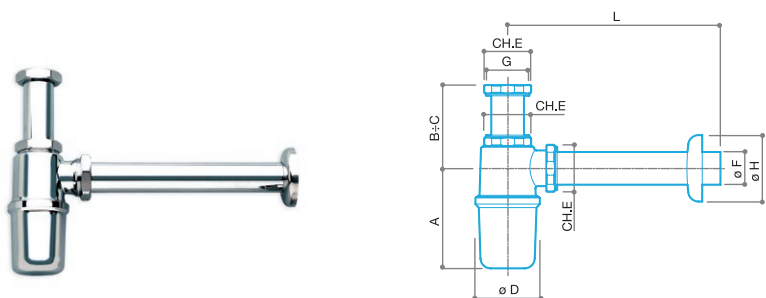

SIF 001

Bottle brass chromed trap without drain, with inspection cap, with stainless steel wall cover.

CODE	SIZE	Ø PIPE x L mm	A	B	C	D	E	F	G	H	L			
93323401	G 1"	26 x 200	80	43	100	55	36	26	G 1"	75	223	434	1	40
93323403		26 x 250	80	43	100	55	36	26	G 1"	75	273	442	1	40
93323404		26 x 250	80	43	140	55	36	26	G 1"	75	273	450	1	40

93324201	G 1 1/4	32 x 200	98	50	103	64	44	32	G 1 1/4	75	223	496	1	40
93324203		32 x 250	98	50	103	64	44	32	G 1 1/4	75	273	504	1	40
93324204		32 x 250	98	50	143	64	44	32	G 1 1/4	75	273	512	1	40

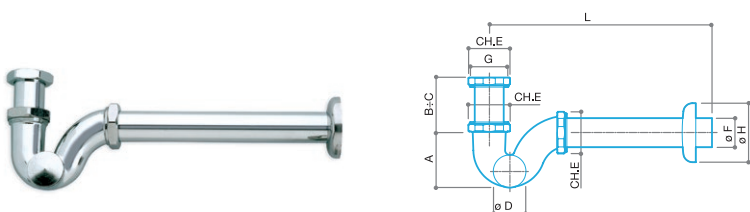

SIF 002

"S" trap for bidet. Brass chromed trap without drain, with inspection cap, with stainless steel wall cover.

CODE	SIZE	Ø PIPE x L mm	A	B	C	D	E	F	G	H	L			
93363401	G 1"	26 x 200	50	59	74	30	36	26	G 1"	75	265	356	1	40
93363403		26 x 250	50	59	74	30	36	26	G 1"	75	315	364	1	40
93363404		26 x 250	50	59	114	30	36	26	G 1"	75	315	372	1	40

93364201	G 1 1/4	32 x 200	60	47	58	36	44	32	G 1 1/4	75	265	452	1	40
93364203		32 x 250	60	47	58	36	44	32	G 1 1/4	75	315	460	1	40
93364204		32 x 250	60	47	98	36	44	32	G 1 1/4	75	315	468	1	40

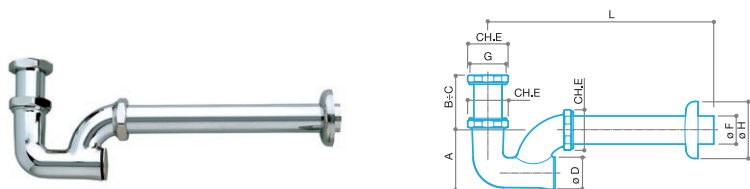

SIF 003

Column trap for wash basin. Brass chromed trap without drain, with inspection cap, with stainless steel wall cover.



CODE	SIZE	Ø PIPE x L mm	A	B	C	D	E	F	G	H	L			
93403401	G 1"	26 x 200	65	53	58	32	36	26	G 1"	75	282	384	1	40
93403403		26 x 250	65	53	58	32	36	26	G 1"	75	332	392	1	40
93403404		26 x 250	65	53	98	32	36	26	G 1"	75	332	400	1	40

93404201	G 1 1/4	32 x 200	67	51	58	36	44	32	G 1 1/4	75	276	458	1	40
93404203		32 x 250	67	51	58	36	44	32	G 1 1/4	75	326	466	1	40
93404204		32 x 250	67	51	98	36	44	32	G 1 1/4	75	326	474	1	40

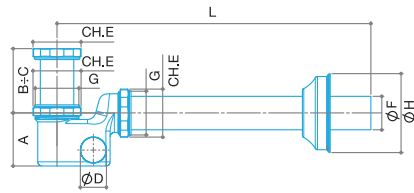
* shank 120 mm



**SIF 004**

Compact trap. Brass chromed trap without drain, with inspection cap, with stainless steel wall cover.

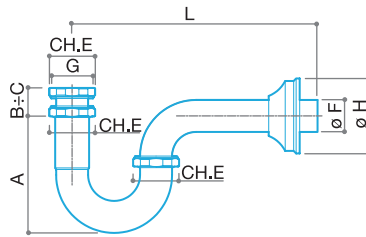
CODE	SIZE	Ø PIPE x L mm	A	B	C	D	E	F	G	H	L			
93444203	G 1"1/4	32 x 250	51	30	50	25	44	32	G 1"1/4	75	300	571	1	40



**SIF 017**

Trap for wash basin. Brass pipe trap without drain, with chromed brass wall cover.

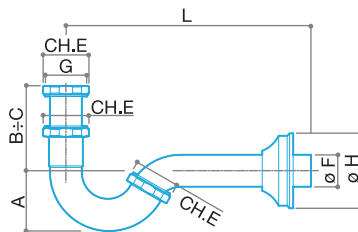
CODE	SIZE	A	B	C	D	E	F	G	H	L			
93544200	G 1"1/4	118	28	65	-	44	32	G 1"1/4	75	317	400	1	40

**SIF 018**

Trap for bidet. Brass pipe trap without drain, with chromed brass wall cover.

CODE	SIZE	A	B	C	D	E	F	G	H	L			
93524200	G 1"1/4	62	80	100	-	44	32	G 1"1/4	75	310	396	1	40



TRAPS

7.2 / PREMIUM SERIES

PREMIUM SERIES

LUXURY TRAPS

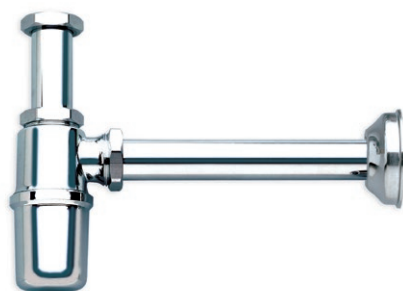

Luxor's traps offer the quality and the guarantee of a Made in Italy product.

The range of items, highly appreciated by the installers for their solidity and long last performance, includes the type of traps commonly used for the washbasin, bidet.

TECHNICAL DATA



Body material

CW 617 N - DW UNI-EN 12165:2016



Wall cover material

CW 508L



Shank and sleeve material

CW 508L



Finish

Chrome

FIELDS OF APPLICATION



washbasins



kitchen
washbasins



bidet

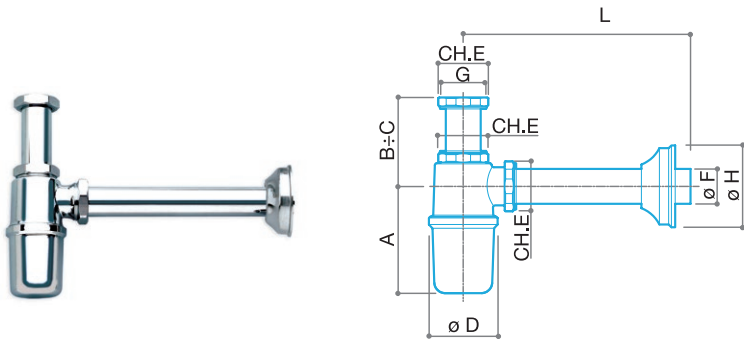

SIF 005

Luxury bottle trap. Brass chromed trap without drain, with inspection cap, with chromed brass wall cover.

CODE	SIZE	Ø PIPE x L mm	A	B	C	D	E	F	G	H	L			
93023400	G 1"	26 x 250	80	43	100	55	36	26	G 1"	75	273	438	1	40
93023404		26 x 250	80	43	140	55	36	26	G 1"	75	273	446	1	40

93024200	G 1 1/4	32 x 250	98	50	103	64	44	32	G 1 1/4	75	273	572	1	40
93024204		32 x 250	98	50	143	64	44	32	G 1 1/4	75	273	578	1	40

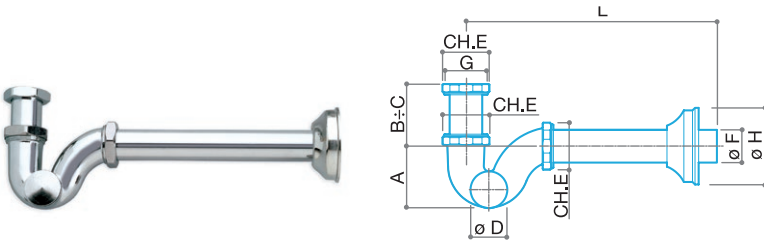

SIF 006

Luxury "S" trap for bidet. Brass chromed trap without drain, with inspection cap, with chromed brass wall cover.

CODE	SIZE	Ø PIPE x L mm	A	B	C	D	E	F	G	H	L			
93163400	G 1"	26 x 250	50	59	74	30	36	26	G 1"	75	315	360	1	40
93163404		26 x 250	50	99	114	30	36	26	G 1"	75	315	368	1	40

93164200	G 1 1/4	32 x 250	60	47	58	36	44	32	G 1 1/4	75	315	454	1	40
93164204		32 x 250	60	87	98	36	44	32	G 1 1/4	75	315	462	1	40

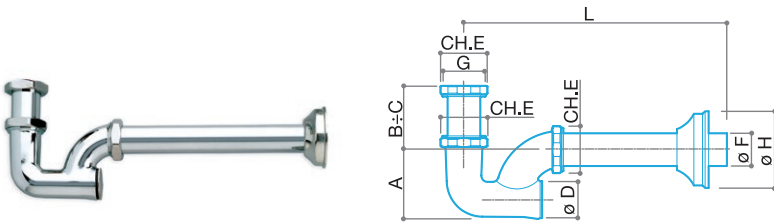

SIF 007

Luxury column trap for wash basin. Brass chromed trap without drain, with inspection cap, with chromed brass wall cover.

CODE	SIZE	Ø PIPE x L mm	A	B	C	D	E	F	G	H	L			
93203400	G 1"	26 x 250	65	53	58	32	36	26	G 1"	75	332	388	1	40
93203404		26 x 250	65	93	98	32	36	26	G 1"	75	332	396	1	40

93204200	G 1 1/4	32 x 250	67	51	58	36	44	32	G 1 1/4	75	332	460	1	40
93204204		32 x 250	67	91	98	36	44	32	G 1 1/4	75	332	468	1	40

* shank 120 mm



TRAPS

7.3 / PL SERIES

PL SERIES

ABS TRAPS

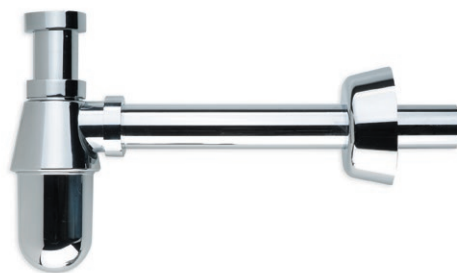

Luxor's traps offer the quality and the guarantee of a Made in Italy product.

The range of items, highly appreciated by the installers for their solidity and long last performance, includes the type of traps commonly used for the washbasin, bidet.

In each box of traps in ABS you will find a pair of gloves for a better care and cleaning of the traps during the installation.

TECHNICAL DATA



Body material

Chromed ABS



Wall cover material

Chromed ABS



Shank and sleeve material

Chromed ABS



Finish

Chrome

FIELDS OF APPLICATION



washbasins



kitchen
washbasins



bidet

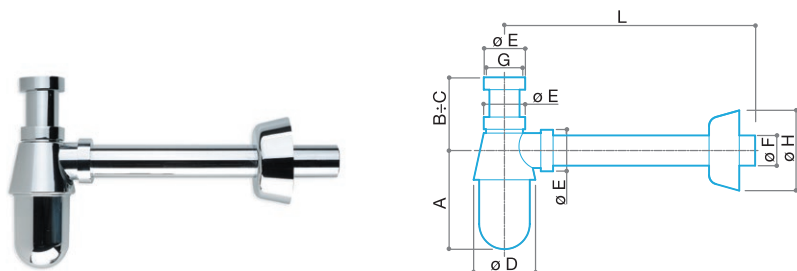

SIF 008

Bottle trap in abs. Chromed ABS trap, without drain, inspectable, with wall cover in chromed ABS.

CODE	SIZE	Ø PIPE x L mm	A	B	C	D	E	F	G	H	L			
96023400	G 1"	26 x 250	84	45	121	61	35	26	G 1"	85	287	202	1	10
* 96024200	G 1 1/4	32 x 250	105	48	128	66	44	32	G 1 1/4	85	293	272	1	10

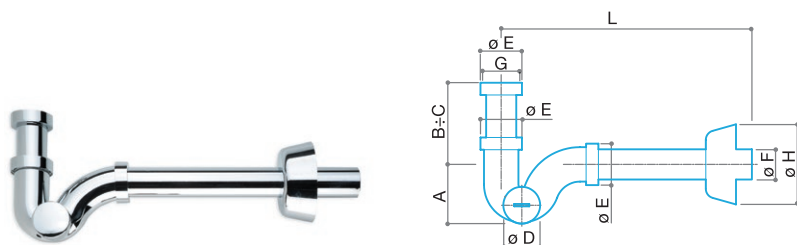

SIF 009

"S" trap for bidet in abs. Chromed ABS trap, without drain, inspectable, with wall cover in chromed ABS.

CODE	SIZE	Ø PIPE x L mm	A	B	C	D	E	F	G	H	L			
96163400	G 1"	26 x 250	68	57	102	35	35	26	G 1"	85	342	188	1	10
96164200	G 1 1/4	32 x 250	63	87	132	39	44	32	G 1 1/4	85	342	228	1	10

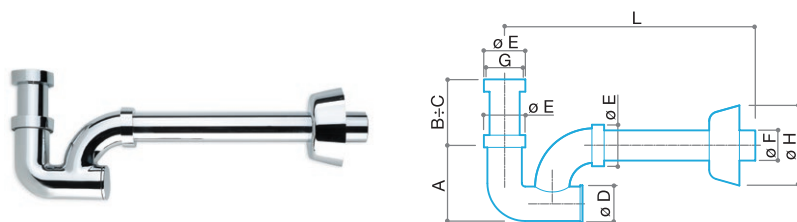

SIF 010

Column trap for wash basin in abs. Chromed ABS trap, without drain, inspectable, with wall cover in chromed ABS.

CODE	SIZE	Ø PIPE x L mm	A	B	C	D	E	F	G	H	L			
96203400	G 1"	26 x 250	67	63	92	35	35	26	G 1"	85	345	174	1	10
96204200	G 1 1/4	32 x 250	80	70	110	39	44	32	G 1 1/4	85	350	236	1	10

* Trap in compliance with standard EN 274 with water column > 50 mm



TRAPS

7.4 / 50th SERIES

50th SERIES

FURNISHING TRAPS



CONSTRUCTIVE FEATURES

The furnishing 50th Series are a distinguished excellent product Made in Italy for its design, for its top level finishing and for the technical feature in compliance to the rule UNI EN274. In particular they are in compliance to the dimensional requirement concerning the water column which must be not less than 50 mm.

CHROME PLATING FINISH

The traps are hand polished and produced with frame chrome plating finish, which guarantees a thicker cover and consequently a higher resistance to ageing and corrosion, next to a top level aesthetic finish. This process is carried out employing material and galvanic processes in compliance to the most severe international rules regulating health and environmental safety.

BODY

The bodies of the traps are produced employing brass CW617N with low lead content in compliance to the recent rule UNI EN 12165 giving the guarantee of a product hygienically safe and reliable. The tightening clamps and the inspection cap are in brass CW614N with low lead content in compliance to the European rule UNI EN 12164 which regulates the chemical composition.

DOUBLE O-RING TIGHTNESS

The peculiar and exclusive feature of the furnishing trap Prestige is the double o-ring tightness and the slip-off sleeve.

This system allows to connect the trap to the drain and allows the installers to cut in a second step the drain sleeve without spoiling the whole trap due to a wrong cut on the drain pipe.

This technical solution makes Luxors's furnishing trap a sound reference point for any kind of aesthetic, functioning and installation requirement.

INSPECTION CAP

The brass inspection cap is equipped with an easy cut to facilitate the open/close operation and to simplify the periodical cleaning maintenance. It is not necessary to use any special tool for the inspection, a small coin is just enough.

DRAIN COVER

The wall drain cover is in brass. It is ageing and corrosion resistant and it is polished and chromed on frame with a top level finishing.

TECHNICAL DATA



Body material

CW 617 N - DW UNI-EN 12165:2016



Wall cover material

CW 508L



Shank and sleeve material

CW 508L



Finish

Chrome

FIELDS OF APPLICATION



washbasins



kitchen washbasins



SIF 011

Furnishing brass trap without drain, chrome or black finish, with sleeves, inspection cap, wall cover and collar in chromed brass.

	CODE	SIZE	Ø PIPE x L mm	FINISH	A	B	C	D	E	F	G	H	L			
**	93654200	G 1"1/4	32 x 320	CHROME	95	58	128	52	52	32	G 1"1/4	68	356	950	1	5
**	93654200N	G 1"1/4	32 x 320	BLACK	95	58	128	52	52	32	G 1"1/4	68	356	950	1	5

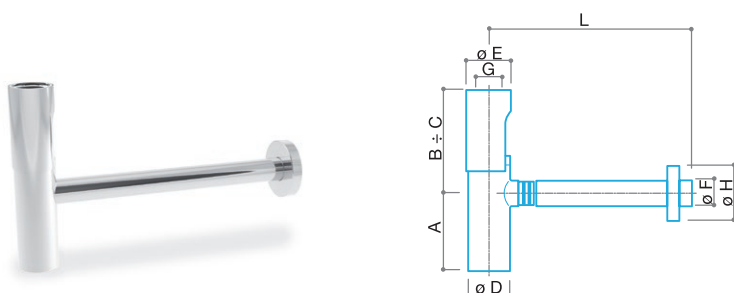

SIF 012

Slide-away trap. Furnishing brass chromed trap, without drain, with sleeves, inspection cap, wall cover, collar and shell in chromed brass.

	CODE	SIZE	Ø PIPE x L mm	A	B	C	D	E	F	G	H	L			
**	93664200	G 1"1/4	32 x 320	95	58	128	52	55	32	G 1"1/4	68	356	1.060	1	5

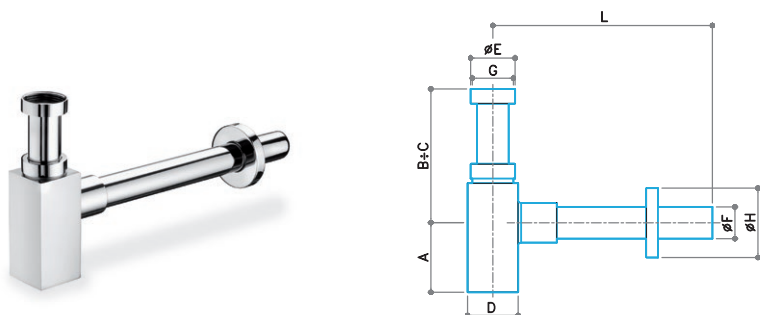

SIF 013

Square trap. Furnishing brass chromed trap, without drain, with sleeves, inspection cap, wall cover and collar in chromed brass.

	CODE	SIZE	Ø PIPE x L mm	A	B	C	D	E	F	G	H	L			
	93634200	G 1" 1/4	32 x 300	70	80	180	50	44	32	G 1"1/4	70	325	890	1	5

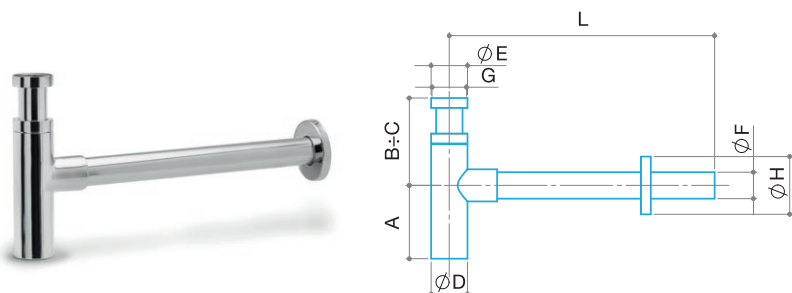

SIF 014



Round trap. Furnishing brass chromed trap, without drain, with sleeves, inspection cap, wall cover and collar in chromed brass.

	CODE	SIZE	Ø PIPE x L mm	A	B	C	D	E	F	G	H	L			
	93624200	G 1" 1/4	32 x 300	89	75	175	44	44	32	G 1"1/4	70	322	680	1	5

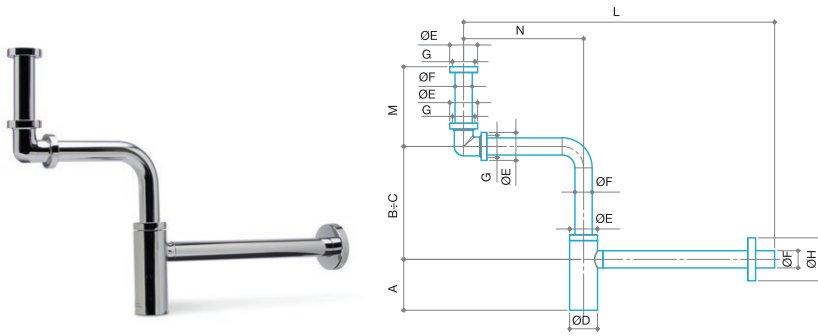
** Trap in compliance with standard EN 274 with water column > 50 mm

**SIF 015**

Space saver prestige trap. Furnishing brass chromed trap, without drain, with sleeves, elbows, inspection cap, wall cover and collar in chromed brass.

CODE	SIZE	Ø PIPE x L mm	A	B	C	D	E	F	G	H	L	M	N		
93674200	G 1" 1/4	32 x 320	95	175	245	52	52	32	G 1"1/4	80	580	140	223	1440	1



TRAPS

7.5 / K SERIES

K SERIES

TRAPS FOR DOMESTIC APPLIANCES



FIELDS OF APPLICATION



washing machines



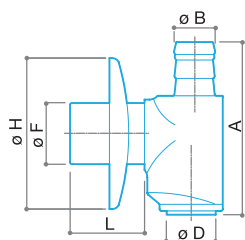

dishwasher



SIF 019

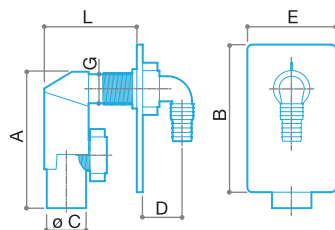

Drain trap for domestic appliances.
Brass chromed trap with check hole
for washing machine and dishwasher
outlet.

CODE	SIZE	A	B	C	D	E	F	G	H	L			
93733400	32 x 40	92	22	-	30	-	32	-	80	40	360	2	20



SIF 020

Drain trap for domestic appliances.
Built-in white plastic trap, with check
hole for dishwasher and washing
machine.

CODE	SIZE	A	B	C	D	E	F	G	H	L			
96264800	40	139	150	40	40	90	-	G 1"	-	94	176	1	50



TRAPS

7.6 / DRAIN PIPES AND ACCESSORIES

DRAIN PIPES AND ACCESSORIES



CONSTRUCTIVE FEATURES

The drain pipes are produced in brass CW508L with low lead content in compliance to the rule UNI EN12449.

RANGE

The range includes: frame chrome plated smooth pipes, pipes with safety end, elbow pipes, and extensions to guarantee a higher resistance to corrosion and ageing.

The chrome process is carried out using material and galvanic methods in compliance to the most strict international rules regulating health and environmental safety.





WALL COVER

The wall cover, polished and chromed, are in both AISI 430 and also in brass and are weatherproof and resisting to the oxidation which could occur during the normal use.







SMOOTH PIPE

Chromed brass outlet pipe.

CODE	SIZE	A	B	C	D	E	F	G	H	L				
35012620	Ø 26	26	-	-	-	-	-	-	-	200	52	-	10	80
35012625		26	-	-	-	-	-	-	-	250	60	-	10	80
35012630		26	-	-	-	-	-	-	-	300	72	-	10	80
35012699		26	-	-	-	-	-	-	-	1000	248	5	-	-
35013020	Ø 30	30	-	-	-	-	-	-	-	200	56	-	10	80
35013025		30	-	-	-	-	-	-	-	250	68	-	10	80
35013030		30	-	-	-	-	-	-	-	300	86	-	10	80
35013099		30	-	-	-	-	-	-	-	1000	290	5	-	-
35013220	Ø 32	32	-	-	-	-	-	-	-	200	64	-	10	80
35013225		32	-	-	-	-	-	-	-	250	72	-	10	80
35013230		32	-	-	-	-	-	-	-	300	88	-	10	80
35013250		32	-	-	-	-	-	-	-	500	148	5	-	-
35013299		32	-	-	-	-	-	-	-	1000	300	5	-	-
35014020	Ø 40	40	-	-	-	-	-	-	-	200	80	-	5	-
35014025		40	-	-	-	-	-	-	-	250	116	-	5	-
35014030		40	-	-	-	-	-	-	-	300	134	-	5	-
35014099		40	-	-	-	-	-	-	-	1000	464	1	-	-

**PIPE WITH COLLAR**

Chromed brass outlet pipe with collar.

CODE	SIZE	A	B	C	D	E	F	G	H	L				
35022620	Ø 26	26	30	-	-	-	-	-	-	200	52	-	10	80
35022625		26	30	-	-	-	-	-	-	250	62	-	10	80
35022630		26	30	-	-	-	-	-	-	300	74	-	10	80





35023020	Ø 30	30	38	-	-	-	-	-	-	200	52	-	10	80
35023025		30	38	-	-	-	-	-	-	250	72	-	10	80
35023030		30	38	-	-	-	-	-	-	300	84	-	10	80

35023220	Ø 32	32	38	-	-	-	-	-	-	200	58	-	10	80
35023225		32	38	-	-	-	-	-	-	250	74	-	10	80
35023230		32	38	-	-	-	-	-	-	300	86	-	10	80

35024020	Ø 40	40	44	-	-	-	-	-	-	200	114	-	5	-
35024025		40	44	-	-	-	-	-	-	250	122	-	5	-
35024030		40	44	-	-	-	-	-	-	300	130	-	5	-

**90° ELBOW PIPE**



Chromed brass outlet pipe with 90° elbow.

CODE	SIZE	A	B	C	D	E	F	G	H	L				
35050400	Ø 30	30	-	-	-	-	-	-	150	250	119	5	-	35
35050200		30	-	-	-	-	-	-	200	300	164	5	-	25

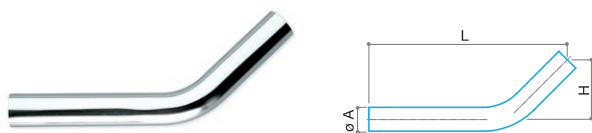
35050600	Ø 32	32	-	-	-	-	-	-	200	250	230	5	-	25
----------	------	----	---	---	---	---	---	---	-----	-----	-----	---	---	----





**45° ELBOW PIPE**

Chromed brass outlet pipe with 45° elbow.

CODE	SIZE	A	B	C	D	E	F	G	H	L				
35060225	Ø 30	30	-	-	-	-	-	-	75	250	102	5	-	50



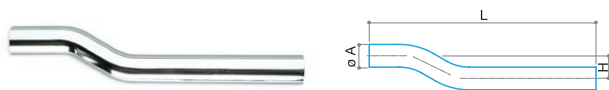

**FLEXIBLE BRASS PIPE**

Flexible chromed brass outlet pipe.

CODE	SIZE	A	B	C	D	E	F	G	H	L				
35032625	Ø 26	26	-	-	-	-	-	-	-	250	66	-	10	-
35032630		26	-	-	-	-	-	-	-	300	86	-	10	-
35033025	Ø 30	30	-	-	-	-	-	-	-	250	86	-	10	-
35033030		30	-	-	-	-	-	-	-	300	102	-	10	-
35033225	Ø 32	32	-	-	-	-	-	-	-	250	94	-	10	-
35033230		32	-	-	-	-	-	-	-	300	99	-	10	-



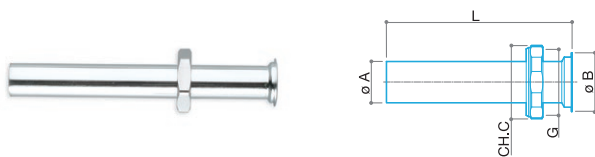

**ECCENTRIC PIPE**

Eccentric outlet chromed brass pipe.

CODE	SIZE	A	B	C	D	E	F	G	H	L				
35152630	Ø 26	26	-	-	-	-	-	-	30	300	150	-	10	-
35153030	Ø 30	30	-	-	-	-	-	-	30	300	164	-	10	-
35153230	Ø 32	32	-	-	-	-	-	-	30	300	178	-	10	-

**PIPE WITH NUT**

Chromed brass pipe with collar and nut.

CODE	SIZE	A	B	C	D	E	F	G	H	L				
35042620	Ø 26	26	37	44	-	-	-	G 1"1/4	-	200	86	-	10	-

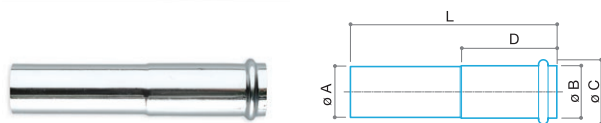



**EXTENSION**

Chromed brass with extension and o-ring.

CODE	SIZE	A	B	C	D	E	F	G	H	L				
35160026	Ø 26	26	28	33	60	-	-	-	-	130	32	-	10	-
35160030	Ø 30	30	32	37	60	-	-	-	-	130	35	-	10	-
35160032	Ø 32	32	33	41	60	-	-	-	-	130	38	-	10	-
35160040	Ø 40	40	42	51	60	-	-	-	-	130	68	-	5	-

**JOINT**

Intermediate chromed brass joint with o-ring.

CODE	SIZE	A	B	C	D	E	F	G	H	L				
35161026	Ø 26	26	28	33	-	-	-	-	-	55	22	-	10	-
35161030	Ø 30	30	32	37	-	-	-	-	-	55	28	-	10	-
35161032	Ø 32	32	33	41	-	-	-	-	-	60	34	-	10	-
35161040	Ø 40	40	42	51	-	-	-	-	-	70	53	-	5	-

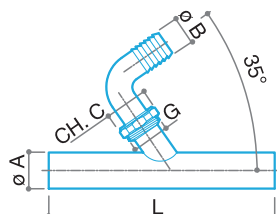

DOMESTIC APPLIANCES OUTLET PIPE

Chromed brass outlet pipe with elbow in chromed ABS for washing machine and dishwasher.

CODE	SIZE	A	B	C	D	E	F	G	H	L				
35200026	Ø 26	26	25	36	-	-	-	G 1"	-	200	138	-	5	-
35200032	Ø 32	32	25	36	-	-	-	G 1"	-	200	142	-	5	-

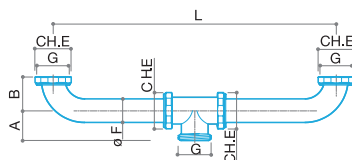

TWO WAYS FITTING

Chromed brass fitting without drain for traps.

CODE	SIZE	A	B	C	D	E	F	G	H	L			
93504200	G 1 1/4	38	43	-	-	44	30	G 1 1/4	-	360	418	1	10



NUTS

Chromed brass nut for traps.

CODE	SIZE	Ø PIPE mm			
97222600CF	G 1"	26	20	25	-
97223200CF	G 1 1/4	32	24	25	-



REDUCTIONS

Chromed brass reduction to adapt the drain to various measures of traps.

CODE	F	M			
94164200	G 1 1/4	G 1"	80	25	-
94164800	G 1 1/2	G 1 1/4	112	20	-



CONICAL TRAP GASKET

Black rubber conical gasket.

CODE	SIZE	Ø PIPE mm			
97172600CF	G 1"	26	1	100	-
97173000CF	G 1 1/4	30	1	100	-
97173200CF	G 1 1/4	32	1	100	-
97174000CF	G 1 1/2	40	1	100	-



CONICAL OUTLET GASKET

Black rubber gasket to adapt outlet pipes.

CODE	SIZE	Ø PIPE mm			
60294032CF	40 x 32 G 1 1/4 G 1 1/2	-	6	50	-

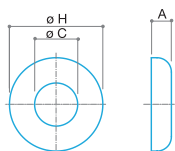
**WALL COVER Ø 65 mm**

Sliding stainless steel wall cover ø 65 mm with round hole.

CODE	SIZE	A	B	C	D	E	F	G	H	L				
30100026CF	Ø 65	14	-	26	-	-	-	-	65	-	12	-	50	-
30100030CF		14	-	30	-	-	-	-	65	-	12	-	50	-
30100032CF		14	-	32	-	-	-	-	65	-	12	-	50	-

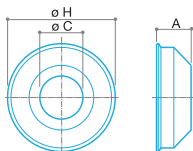
**SHAPED WALL COVER Ø 75 mm**

Sliding shaped stainless steel wall cover ø 75 mm with round hole.

CODE	SIZE	A	B	C	D	E	F	G	H	L				
30090126CF	Ø 75	24	-	26	-	-	-	-	75	-	20	-	25	-
30090130CF		24	-	30	-	-	-	-	75	-	20	-	25	-
30090132CF		24	-	32	-	-	-	-	75	-	20	-	25	-

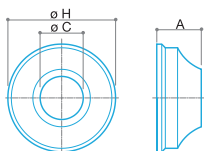

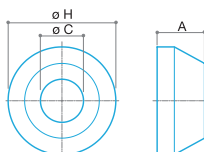

**SHAPED WALL COVER Ø 75 mm**

Sliding shaped stainless steel wall cover ø 75 mm with round hole.

CODE	SIZE	A	B	C	D	E	F	G	H	L				
30090026CF	Ø 75	31	-	26	-	-	-	-	75	-	16	50	-	-
30090030CF		31	-	30	-	-	-	-	75	-	14	50	-	-
30090032CF		31	-	32	-	-	-	-	75	-	14	50	-	-



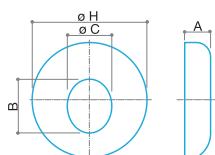

**CONICAL WALL COVER Ø 75 mm**

Chromed brass sliding wall cover ø 75 mm with round hole.

CODE	SIZE	A	B	C	D	E	F	G	H	L				
30070026CF	Ø 75	33	-	26	-	-	-	-	75	-	24	25	-	-
30070030CF		33	-	30	-	-	-	-	75	-	24	25	-	-
30070032CF		33	-	32	-	-	-	-	75	-	24	25	-	-
30070040CF		33	-	40	-	-	-	-	75	-	24	25	-	-

**WALL COVER WITH OVAL HOSE**

Chromed brass sliding wall cover with oval hole.

CODE	SIZE	A	B	C	D	E	F	G	H	L				
30110030CF	Ø 80	18	38	31	-	-	-	-	80	-	22	25	-	-
30110230CF	Ø 110	31	38	31	-	-	-	-	110	-	64	5	-	-

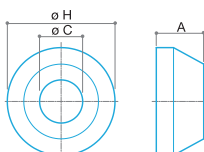

**CONICAL WALL COVER Ø 100 mm**

Chromed brass conical wall cover ø 100 mm suitable for eccentric pipe.

CODE	SIZE	A	B	C	D	E	F	G	H	L				
35120026	Ø 100	43	-	26	-	-	-	-	100	-	58	10	-	-
35120030		43	-	30	-	-	-	-	100	-	56	10	-	-
35120032		43	-	32	-	-	-	-	100	-	56	10	-	-



**STRAIGHT SLEEVE**

White rubber sleeve for w.c. branch.

CODE	SIZE	Ø PIPE mm			
60295000	Ø 100	-	179	1	-



**ECCENTRIC SLEEVE**

White rubber sleeve for w.c. branch.

CODE	SIZE	Ø PIPE mm			
60295100	Ø 100	-	182	1	-



**UNIVERSAL CLAMP**

Rubber reduction clamp for drain pipes.

CODE	SIZE	Ø PIPE mm			
60291000	40	26-30-32	14	25	-
60291100	50	26-30-32	26	25	-
60291200	50	40	22	25	-



**STANDARD CLAMP**

Rubber reduction clamp for drain pipes.

CODE	SIZE	Ø PIPE mm			
60291300	47	26-30-32	22	25	-
60291400		40	12	25	-



**UNIVERSAL WC CLAMP**

Rubber reduction clamp for w.c.

CODE	SIZE	Ø PIPE mm			
60290200	50	30-32	28	50	-

**UNIVERSAL WC CLAMP**

Rubber reduction clamp for w.c.

CODE	SIZE	Ø PIPE mm			
60300000	60	30-32	34	50	-

