



6 / ANGLE VALVES

ANGLE VALVES



Luxor Spa shut-off angle valves are high-quality products that can be used in various fields of application: from the well-established use-case under washbasins to connections for toilet cisterns, washing machines and dishwashers.

Both chrome-plated copper pipes and flexible hoses can be connected to the Luxor Spa shut-off angle valves. Luxor Spa angle valves are versatile, safe and easy to install.

APPLICATIONS



washbasins



bidet



toilet cisterns



washing machines



dishwashers

RANGE

The Luxor Spa range of angle valves covers all types of plumbing applications and meets the needs of users: they are versatile, easy to install and guaranteed over time.

Luxor Spa angle valves can be fitted with a screw-down or ball shut-off, inspection plug and filter, and swivel connection fittings.

All Luxor Spa angle valves are pressure tested to ensure correct sealing. Luxor Spa angle valves come with accessories such as compression fittings, reductions and hole cover washers.



Starx

Screw-down angle valves with filter



Deltax

Screw-down angle valves without filter



Spheralux

Undersink ball angle valves



50TH Series

Decorative undersink angle valves



SC Series

Cistern angle valves



K Series

Multipurpose angle valves for household appliances



LUXOR®

ANGLE VALVES

6.1 / STARX

STARX







SCREW-DOWN ANGLE VALVES WITH FILTER



The STARX series of screw-down angle valves with filter are high quality products that can be used in various applications in addition to the established undersink use.

Both chrome-plated copper pipes and flexible hoses can be connected: STARX angle valves are versatile, safe and easy to install.

TECHNICAL FEATURES

 Max temperature 90 °C	 Max pressure 10 bar	 Material CW617N
 Knob ABS	 Testing 100%	 Installation instructions Page 19

FIELDS OF APPLICATION



washbasins



bidet

EASY-OUT
Easy replacement of the filter system

NEW DESIGN
Aesthetic and functional optimization

DOUBLE O-RING
Protected threads and maximum sealing guaranteed

NYLON SCREW
Prevents the build-up of limescale and water impurities

NYLON SCREW

The screw is made of Nylon (Polyamide 6.6). In addition to its excellent hygienic qualities, the screw possesses excellent mechanical properties that allow it to work without any impairment both at

high and low temperatures, and enable it to withstand the tensile, torsion and impact stresses to which the angle valve may be subjected during normal use.

THE RANGE

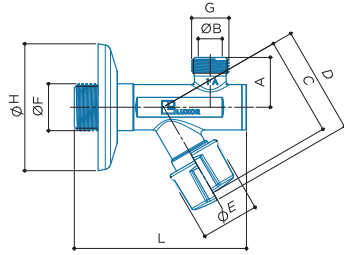

S 19

Undersink screw-down angle valve with filter and sliding collar.

CODE	SIZE	A	B	C	D	E	F	G	H	L	M	N	P			
70502100	G 1/2 - G 3/8	22	10	44	47,5	25,6	G 1/2	G 3/8	56	76	-	-	-	141	10	100

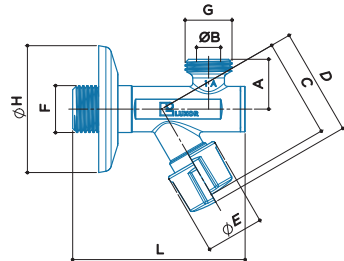

S 20

Undersink stop angle valve with filter and sliding collar.

CODE	SIZE	A	B	C	D	E	F	G	H	L	M	N	P			
70512100	G 1/2 - G 1/2	22	10	44	47,5	25,6	G 1/2	G 1/2	56	76	-	-	-	144	10	100

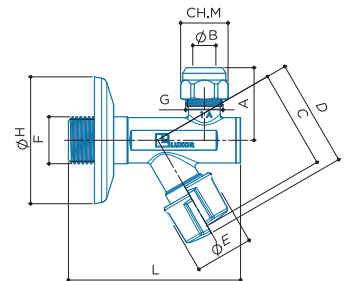

S 23

Undersink screw-down angle valve with filter, sliding collar and 3-piece cartridge.

CODE	SIZE	A	B	C	D	E	F	G	H	L	M	N	P			
70502101CC	G 1/2 - G 3/8	32	10	44	47,5	25,6	G 1/2	G 3/8	56	76	19	-	-	156	10	100

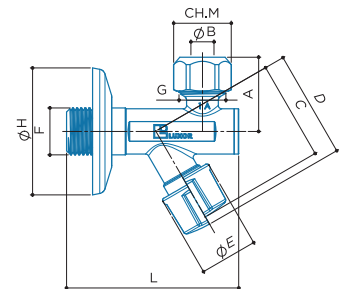

S 24

Undersink screw-down angle valve with filter, sliding washer and Teflon ogive.

CODE	SIZE	A	B	C	D	E	F	G	H	L	M	N	P			
70512101	G 1/2 - G 1/2	33	10	44	47,5	25,6	G 1/2	G 1/2	56	76	23	-	-	169	10	100

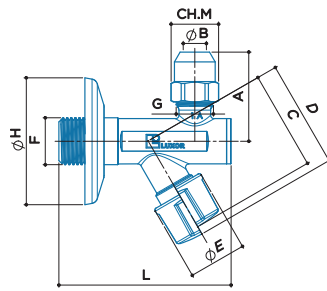

S 27

Undersink screw-down angle valve with filter, sliding collar and 3-piece high nut cartridge.

CODE	SIZE	A	B	C	D	E	F	G	H	L	M	N	P			
70502102CC	G 1/2 - G 3/8	40	10	44	47,5	25,6	G 1/2	G 3/8	56	76	19	-	-	162	10	100

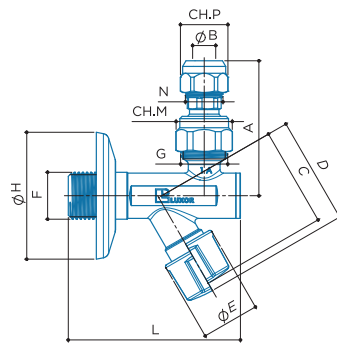

S 30

Undersink screw-down angle valve with filter, sliding collar and 3-piece cartridge with swivel outlet.

CODE	SIZE	A	B	C	D	E	F	G	H	L	M	N	P			
70512111CC	G 1/2 - G 3/8	60	10	44	47,5	25,6	G 1/2	G 1/2	56	76	23	G 3/8	19	198	10	100

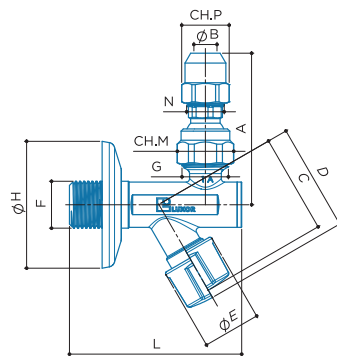

S 31

Undersink screw-down angle valve with filter, sliding collar and 3-piece cartridge, high nut with swivel outlet.

CODE	SIZE	A	B	C	D	E	F	G	H	L	M	N	P			
70512112CC	G 1/2 - G 3/8	67	10	44	47,5	25,6	G 1/2	G 1/2	56	76	23	G 3/8	19	205	10	100

FLOW RATE DIAGRAM

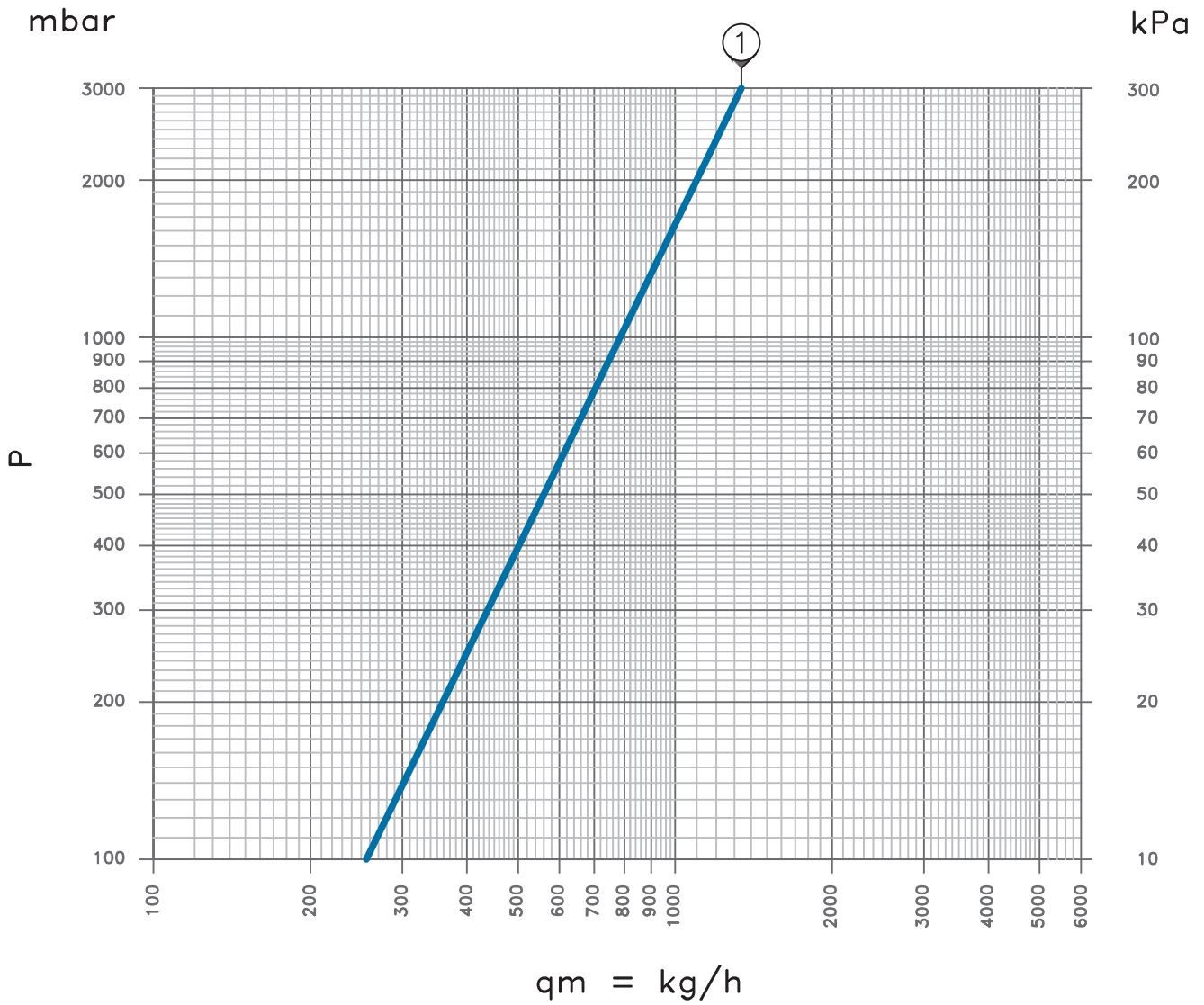

ARTICLES	CODE	Kv
S 19	70502100	0,75
S 20	70512100	
S 23	70502101CC	
S 24	70512101	
S 27	70502102CC	
S 30	70512111CC	
S 31	70512112CC	



ANGLE VALVES







6.2 / DELTAX

DELTAX

SCREW-DOWN ANGLE VALVES WITHOUT FILTER



TECHNICAL FEATURES

 Max temperature 90 °C	 Max pressure 10 bar	 Material CW617N
 Knob ABS	 Testing 100%	 Installation instructions Page 19

FIELDS OF APPLICATION



washbasins



bidet

NYLON SCREW

The screw is made of Nylon (Polyamide 6.6). In addition to its excellent hygienic qualities, the screw possesses excellent mechanical properties that allow it to work without any impairment both at

high and low temperatures, and enable it to withstand the tensile, torsion and impact stresses to which the angle valve may be subjected during normal use.

THE RANGE

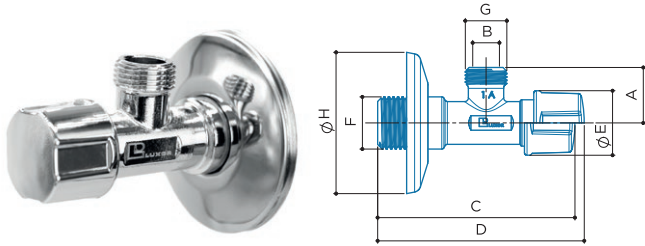

S 2

Undersink screw-down angle valve without filter with sliding collar.

CODE	SIZE	A	B	C	D	E	F	G	H	L	M			
70202100	G 1/2 - G 3/8	22	10	78,2	81,9	25,6	G1/2	G3/8	56	-	-	93	10	100

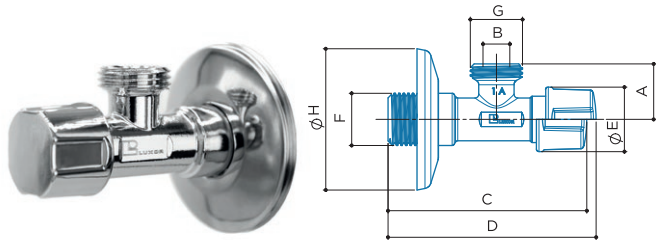

S 3

Undersink screw angle valve without filter with sliding collar.

CODE	SIZE	A	B	C	D	E	F	G	H	L	M			
70212100	G 1/2 - G 1/2	22	10	78,2	81,9	25,6	G1/2	G1/2	56	-	-	97	10	100

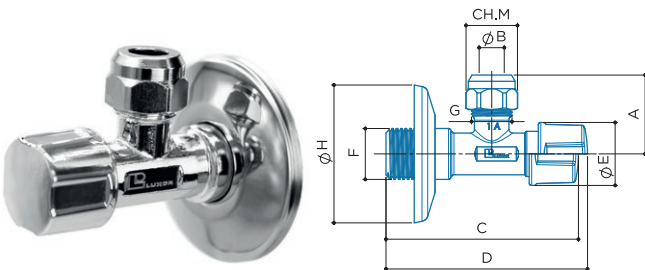

S 7

Undersink screw-down angle valve without filter with sliding collar and 3-piece cartridge.

CODE	SIZE	A	B	C	D	E	F	G	H	L	M			
70202101CC	G 1/2 - G 3/8	32	10	78,2	81,9	25,6	G1/2	G3/8	56	-	19	108	10	100

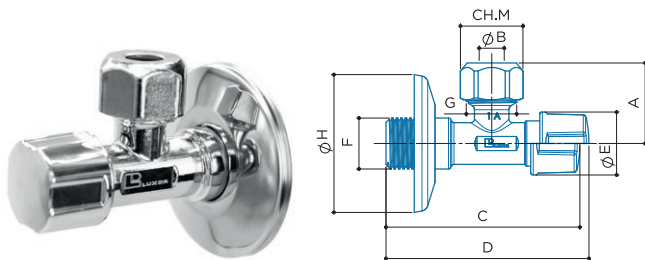

S 8

Undersink screw-down angle valve without filter with sliding collar and Teflon ogive.

CODE	SIZE	A	B	C	D	E	F	G	H	L	M			
70212101	G 1/2 - G 1/2	32,8	10	78,2	81,9	25,6	G1/2	G1/2	56	-	23	122	10	100

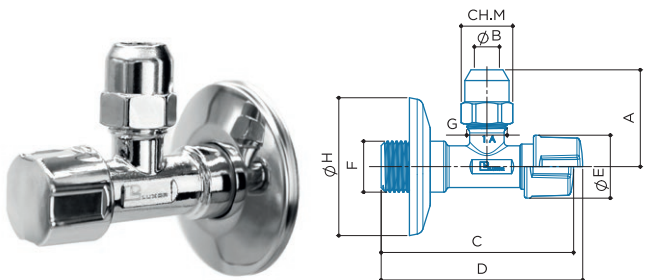

S 12

Undersink screw-down angle valve without filter with sliding collar and 3-piece high nut cartridge.

CODE	SIZE	A	B	C	D	E	F	G	H	L	M			
70202102CC	G 1/2 - G 3/8	39	10	78,2	81,9	25,6	G1/2	G3/8	56	-	19	113	10	100

FLOW RATE DIAGRAM

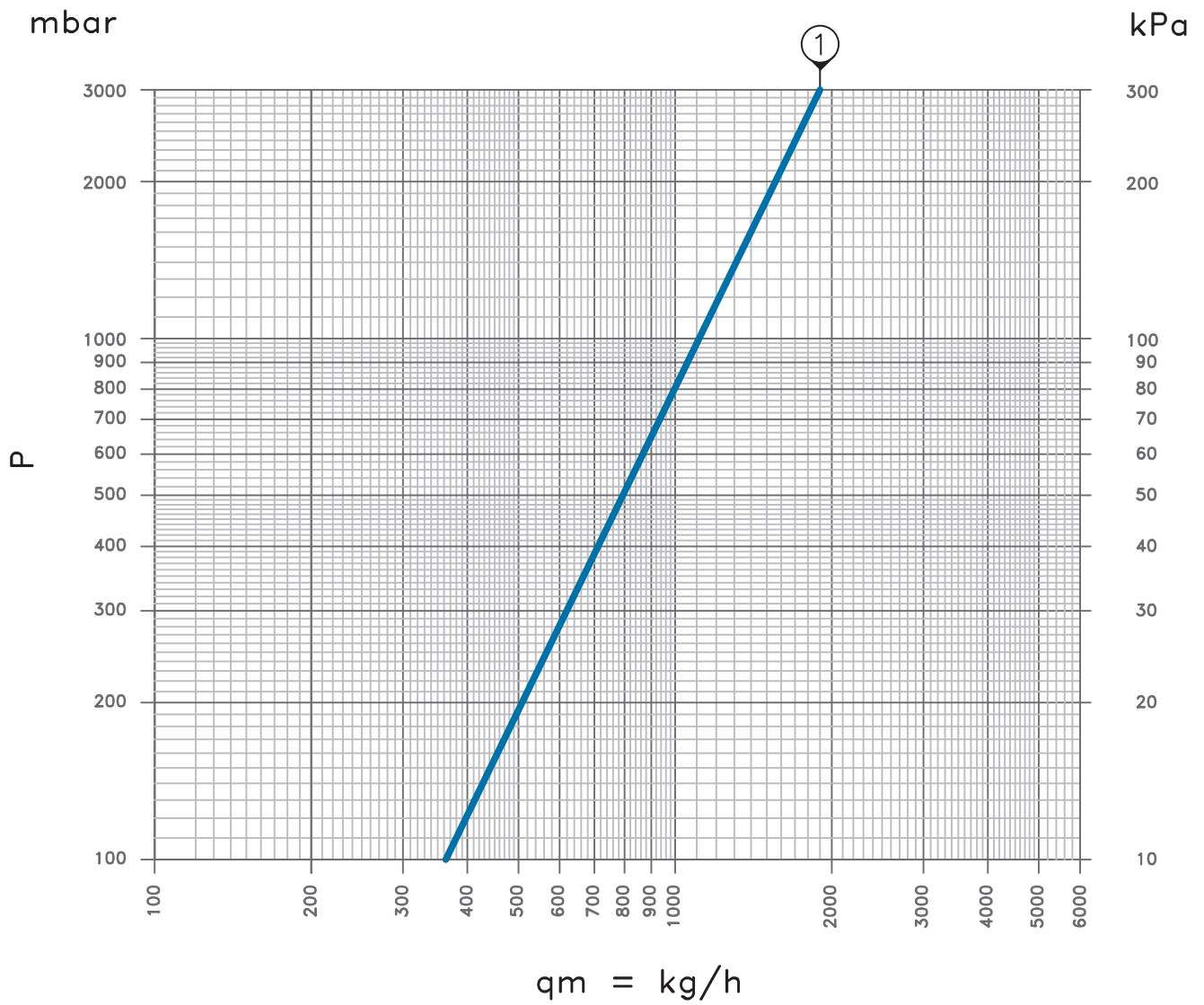

ARTICLES	CODE	Kv
S 2	70202100	1,1
S 3	70212100	
S 7	70202101CC	
S 8	70212101	
S 12	70202102CC	



ANGLE VALVES

6.3 / SPHERALUX

SPHERALUX

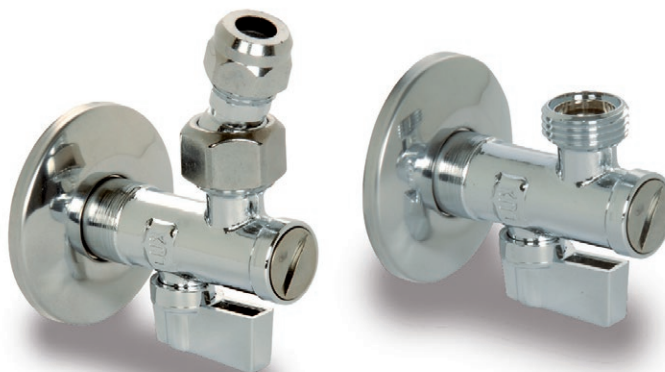

UNDERSINK BALL ANGLE VALVES



Ball angle valves offer the practicality of the classic short stroke closure combined with the quality and assurance of a Made in Italy product.

The range includes standard angle valves and angle valves with a directional outlet using articulated fittings for ease of installation.

TECHNICAL FEATURES

		
Max temperature	Max pressure	Material
90 °C	10 bar	CW617N
		
Knob	Testing	Installation instructions
ABS	100%	Page 19

FIELDS OF APPLICATION



washbasins



bidet

BALL AND CONTROL ROD

The ball and the control rod are made of CW614N brass with low lead content in compliance with European standard UNI EN12164, which establishes the chemical composition characteristics. The ball is sealed with virgin PTFE gaskets, while the control rod uses an EPDM double O-ring

safety system, which preserves its sealing characteristics and mechanical resistance over time. All the seals used, PTFE and EPDM, are manufactured in accordance with the strictest international health and environmental safety regulations.

FILTER

The filter is made of weatherproof and oxidation-resistant AISI 304 stainless steel. The special inspection cap has a convenient notch to facilitate opening/closing and to simplify filter cleaning.

HANDLE

The handle, with its convenient quarter-turn closure, is made of ABS with a chrome finish and has strong mechanical properties which enable it to withstand the tensile, torsional and impact stresses which the angle valve may be subjected to during normal use.

GUARANTEED SEAL

All Luxor Spa, ball angle valves are carefully checked under 100% in-line pressure during the assembly phase of the items to ensure tightness and avoid possible leaks after final installation.

THE RANGE

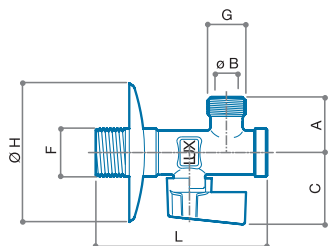

V 35

Undersink ball angle valve with filter and sliding collar.

CODE	SIZE	A	B	C	D	E	F	G	H	L	M	N	P			
70902100	G 1/2 - G 3/8	24	10	31	-	-	G 1/2	G 3/8	56	74	-	-	-	128	10	100

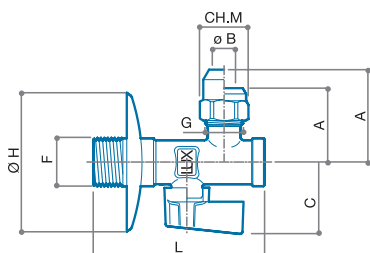

V 43

Undersink ball angle valve with filter, sliding collar and 3-piece high nut cartridge.

CODE	SIZE	A	B	C	D	E	F	G	H	L	M	N	P			
70902102CC	G 1/2 - G 3/8	40	10	31	-	-	G 1/2	G 3/8	56	74	19	-	-	148	10	100

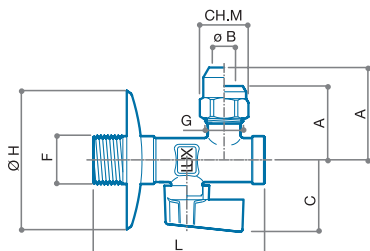

V 39

Undersink ball angle valve with filter, sliding collar and 3-piece cartridge.

CODE	SIZE	A	B	C	D	E	F	G	H	L	M	N	P			
70902101CC	G 1/2 - G 3/8	32	10	31	-	-	G 1/2	G 3/8	56	74	19	-	-	142	10	100

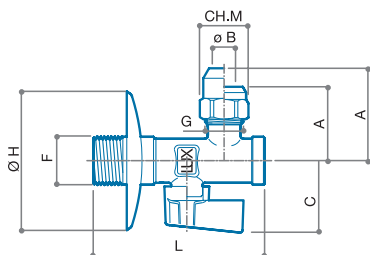

V 40

Undersink ball angle valve with filter, sliding collar and Teflon ogive.

CODE	SIZE	A	B	C	D	E	F	G	H	L	M	N	P			
70912101	G 1/2 - G 1/2	32	10	31	-	-	G 1/2	G 1/2	56	74	23	-	-	162	10	100

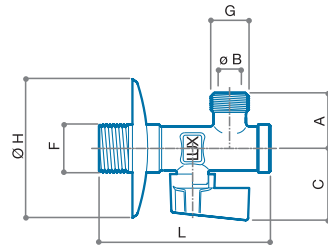

V 36

Undersink ball angle valve with filter and sliding collar.

CODE	SIZE	A	B	C	D	E	F	G	H	L	M	N	P			
70912100	G 1/2 - G 1/2	24	10	31	-	-	G 1/2	G 1/2	56	74	-	-	-	134	10	100

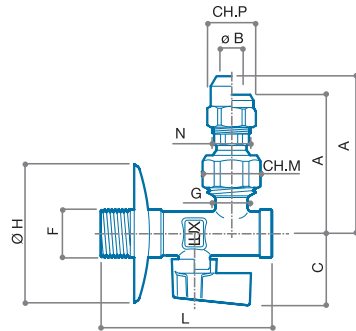

V 46

Undersink ball angle valve with filter, sliding collar and 3-piece cartridge with swivel outlet.

CODE	SIZE	A	B	C	D	E	F	G	H	L	M	N	P			
7091211CC	G 1/2 - G 3/8	62	10	31	-	-	G 1/2	G 1/2	56	74	23	G 3/8	19	192	10	100

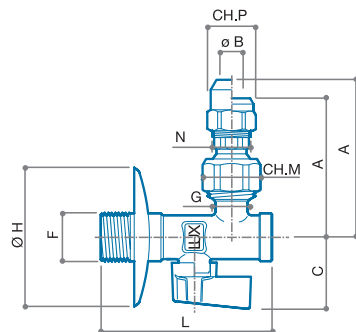

V 47

Undersink ball angle valve with filter, sliding collar and 3-piece high nut cartridge, 3-piece high nut cartridge with swivel outlet.

CODE	SIZE	A	B	C	D	E	F	G	H	L	M	N	P			
7091212CC	G 1/2 - G 3/8	68	10	31	-	-	G 1/2	G 1/2	56	74	23	G 3/8	19	198	10	100

INSTALLATION INSTRUCTIONS FOR STARX, DELTAX AND SPHERALUX ANGLE VALVES

For the correct assembly of the rigid connections under the basin it is necessary to follow the instructions shown below, carefully checking the assembly direction of the cartridge and seals. It is therefore important to first connect the nipple with washer to the water mains, correctly insert any gaskets between the small elbow and the nipple, insert the RCC cartridge into the tightening nut, paying attention

to the direction of insertion, and, finally, tighten the fitting to the tube.

Caution:

- Check the correct direction of the cartridge;
- Recommended tightening torque 25 to 30 Nm max.

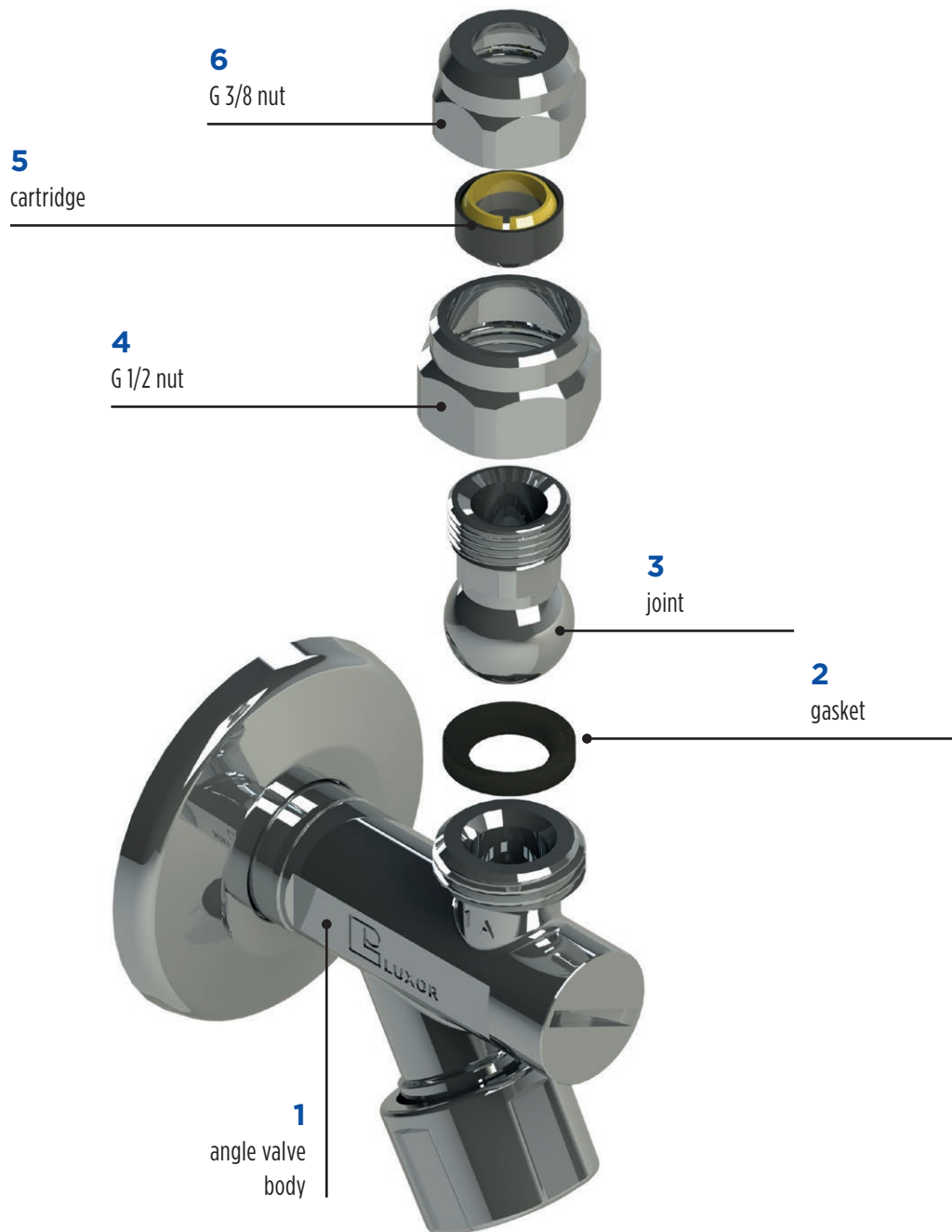

FLOW RATE DIAGRAM

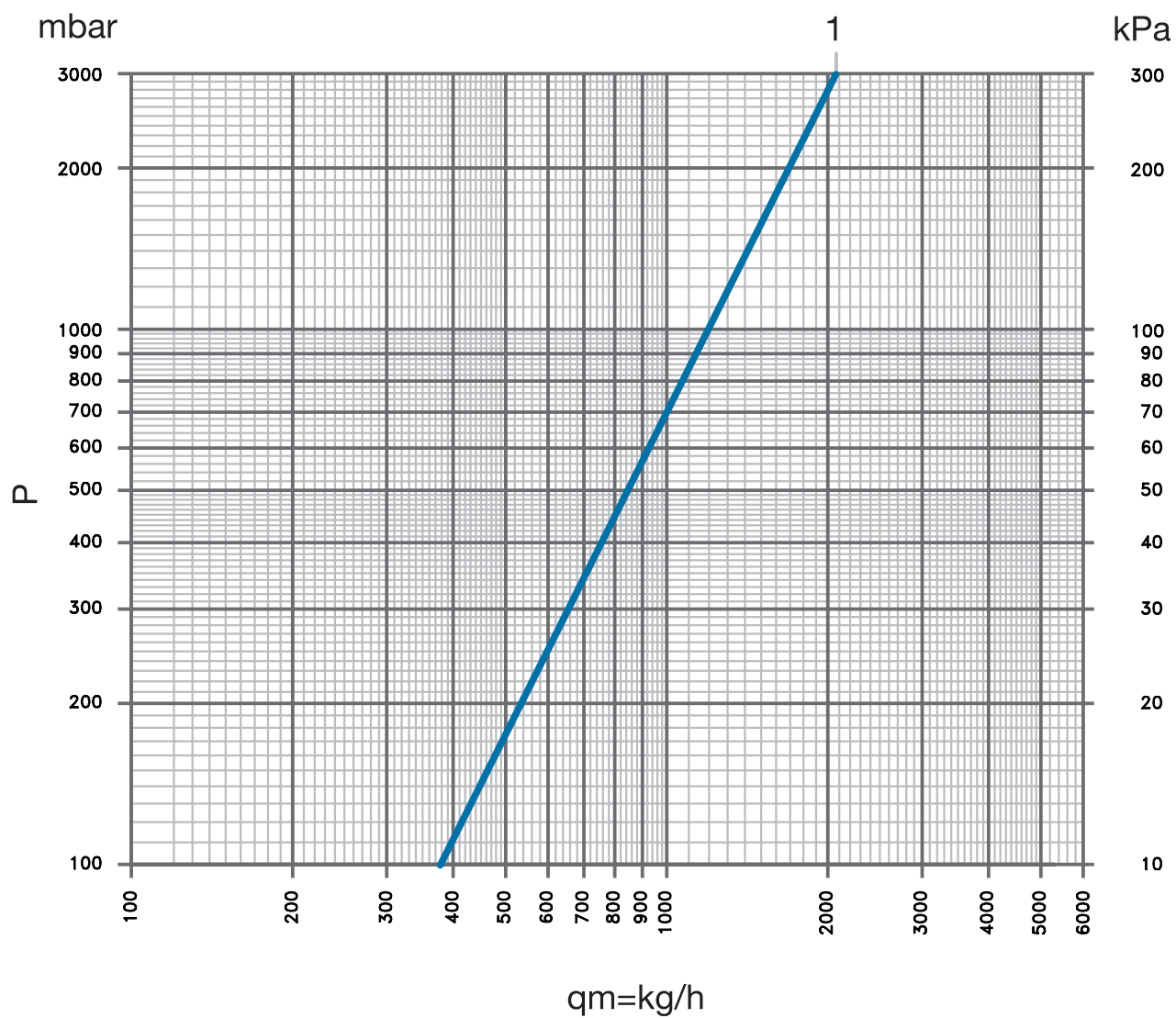

ARTICLES	CODE	Kv
V 35	70902100	1,20
V 36	70912100	
V 39	70902101CC	
V 40	70912101	
V 43	70902102CC	
V 46	70912111CC	
V 47	70912112CC	



LUXOR®

ANGLE VALVES

6.4 / 50th SERIES

50th SERIES

DECORATIVE UNDERSINK ANGLE VALVES



The entire 50th Series range of angle valves is produced with chrome drag finishing which ensures maximum durability of the products. The bodies of the angle valves are made using CW617N brass with a low lead content.

The screw is made of CW614N brass and all seals are made of peroxide EPDM. 50th Series angle valves undergo a double polishing process to achieve an excellent finish.

TECHNICAL FEATURES



Max temperature

90 °C



Max pressure

10 bar



Material

CW617N



Knob

ABS

FIELDS OF APPLICATION



washbasins



bidet

THE RANGE



CHROME



BLACK

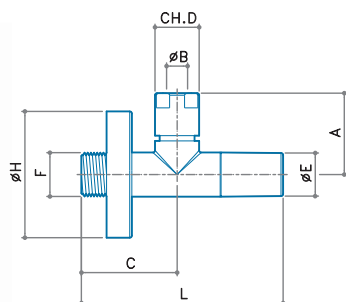

S 53

Kit consisting of: 2 straight undersink angle valves with fixed rod, sliding collar and 3-piece cartridge.

CODE	SIZE	FINISH	A	B	C	D	E	F	G	H	L	M			
7095210ICC	G 1/2 - G 3/8	CHROME	39	10	46	19	21	G 1/2	-	60	96	-	400	1	12
7095210CCN	G 1/2 - G 3/8	BLACK	39	10	46	19	21	G 1/2	-	60	96	-	400	1	12



CHROME



BLACK

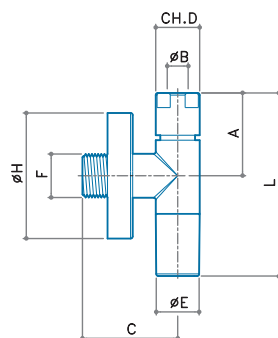

S 54

Kit consisting of: 2 angle valves with fixed rod, sliding collar and 3-piece cartridge.

CODE	SIZE	FINISH	A	B	C	D	E	F	G	H	L	M			
7097210ICC	G 1/2 - G 3/8	CHROME	39	10	46	19	21	G 1/2	-	60	88	-	388	1	12
7097210CCN	G 1/2 - G 3/8	BLACK	39	10	46	19	21	G 1/2	-	60	88	-	388	1	12

FLOW RATE DIAGRAM

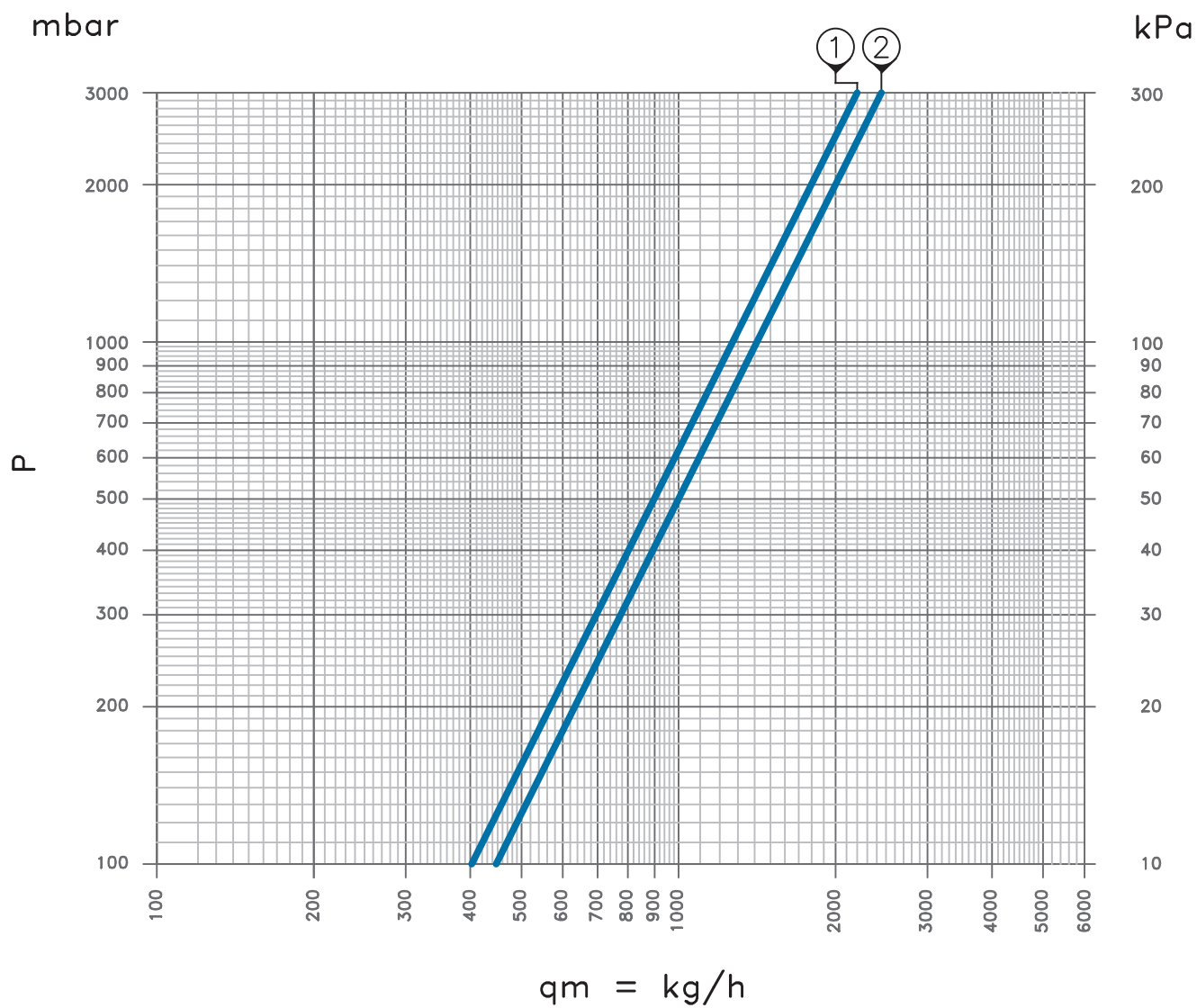

ARTICLES	CODE	ELBOW	Kv
S 53	70952101CC	1	1,4
	70952101CCN		
S 54	70972101CC	2	1,45
	70972101CCN		



ANGLE VALVES

6.5 / SC SERIES

SC SERIES

CISTERN ANGLE VALVES



This range of angle valves is mainly used to connect toilet flush cisterns to the water mains. In addition to the compact screw-down angle valve, the range also includes assembly kits with copper tubes, compression fittings, connection nip-

ples and washers. The completeness and versatility of these products facilitates and simplifies installation procedures in a wide variety of use cases.

TECHNICAL FEATURES



Max temperature

90 °C



Max pressure

10 bar



Material

CW617N



Knob

ABS



Testing

100%

FIELDS OF APPLICATION



toilet cisterns

NYLON SCREW

The screw is made of Nylon (Polyamide 6.6). In addition to its excellent hygienic qualities, the screw possesses excellent mechanical properties that allow it to work without any impairment both at

high and low temperatures, and enable it to withstand the tensile, torsion and impact stresses to which the angle valve may be subjected during normal use.

TUBES

The connection tubes are manufactured using Cu-DHP quality phosphorus deoxidised copper with chemical composition Cu 99.9% min, whose mechanical characteristics, dimensions and tolerances comply with EN1057 and related standards. All manufactured parts are rigorously washed in ultrasonic tanks with neutral agents to eliminate residual processing substances.

HANDLE

The ergonomic handle is made of ABS with a chrome finish and has strong mechanical properties that allow it to withstand the tensile, torsion and impact stresses which the angle valve may be subjected to during normal use.

COLLARS

The collars are made of AISI 430 stainless steel and are resistant to weathering, alkaline solutions of organic acids and oxidation up to high temperatures.

THE RANGE

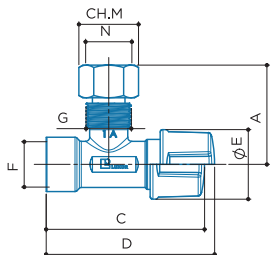

S 60
Cistern angle valve.

CODE	SIZE	A	B	C	D	E	F	G	H	L	N			
70600100	F 3/8 - M 3/8 - F 3/8	36	-	58,2	61,9	25,6	G 3/8	G 3/8	-	-	G 3/8	79	10	100

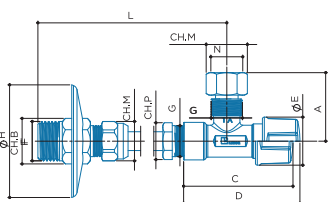

S 61
Cistern angle valve with sliding collar,
20cm chrome-plated copper tube and
3-piece cartridge.

CODE	SIZE	A	B	C	D	E	F	G	H	L	M	N	P			
70600020CC	MPR 1/2 - F 3/8	36	21	58,2	61,9	25,6	G 1/2	G 3/8	60	208	19	G 3/8	17	206	10	80

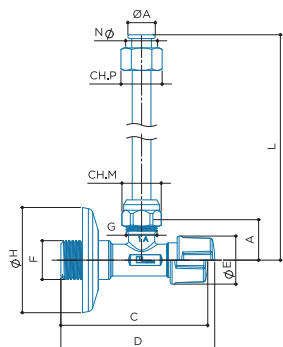

S 62
Cistern angle valve with sliding collar,
25cm chrome-plated copper tube and
3-piece cartridge.

CODE	SIZE	A	B	C	D	E	F	G	H	L	M	N	P			
7061030CC	M 1/2 - F 3/8	14	-	78,2	81,9	25,6	G 1/2	G 3/8	60	258	19	G 3/8	19	175	10	80

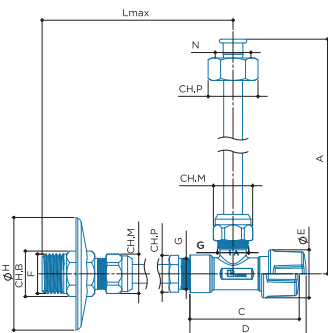

S 63
Cistern angle valve with sliding collar,
20 cm chrome-plated copper tubes and
3-piece cartridge.

CODE	SIZE	A	B	C	D	E	F	G	H	L	M	N	P			
70610025CC	MPR 1/2 - F 1/2	258	21	58,2	61,9	25,6	G 1/2	G 3/8	60	208	19	G 1/2	23	257	10	80
70611025CC	MPR 1/2 - F 3/8	258	21	58,2	61,9	25,6	G 1/2	G 3/8	60	208	19	G 3/8	19	255	10	60

FLOW RATE DIAGRAM

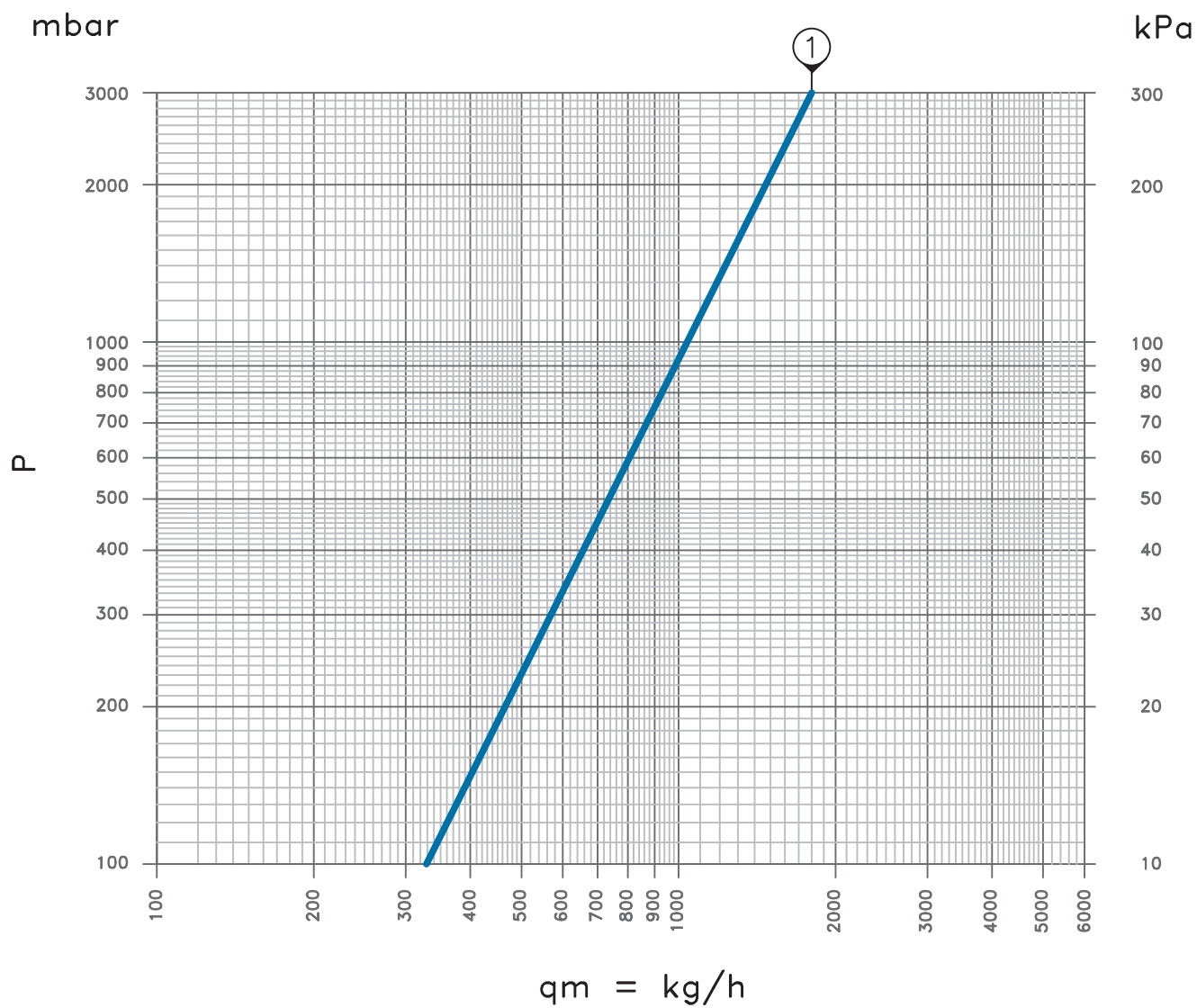

ARTICLES	CODE	Kv
S 60	70600100	1,10
S 61	70600020CC	
S 62	70601030CC	
S 63	70610025CC	
	70611025CC	



LUXOR[®]

ANGLE VALVES

6.6 / K SERIES

K SERIES

MULTIPURPOSE ANGLE VALVES FOR HOUSEHOLD APPLIANCES



The range of multipurpose angle valves includes a variety of items that can be used for the most diverse applications.

The range includes screw-down angle valves, ball angle valves and multi-way valve angle valves, for washing machines, dishwashers and undersink connections.

TECHNICAL FEATURES



Max temperature

90 °C



Max pressure

10 bar



Material

CW617N



Knob

ABS

FIELDS OF APPLICATION



dishwashers



washing machines



washbasins

HANDLE

The ergonomic handle is made of ABS with a chrome finish and has strong mechanical properties that allow it to withstand the tensile, torsion and impact stresses which the angle valve may be subjected to during normal use.

COLLARS

The collars are made of AISI 430 stainless steel and are resistant to weathering, alkaline solutions of organic acids and oxidation up to high temperatures.

THE RANGE

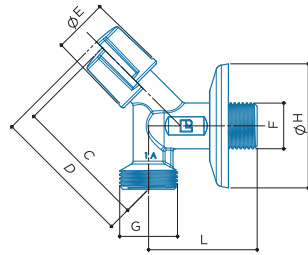

S 70

Washing machine screw-down angle valve with sliding collar and handle inclined at 45°. Without return valve.

CODE	SIZE	A	B	C	D	E	F	G	H	L	M			
70352105	G 1/2 - G 3/4	-	-	60	65	25,6	G1/2	G3/4	56	49	-	142	10	100

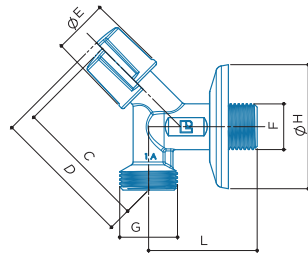

S 71

Washing machine screw-down angle valve with sliding collar and handle inclined at 45° with non-return valve to prevent backflow of polluted water into the water mains.

CODE	SIZE	A	B	C	D	E	F	G	H	L	M			
70352102	G 1/2 - G 3/4	-	-	60	65	25,6	G1/2	G3/4	56	49	-	144	10	100

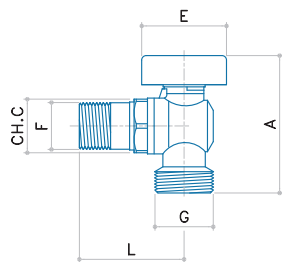

S 72

Ball angle valve for washing machine with butterfly handle.

CODE	SIZE	A	B	C	D	E	F	G	H	L	M			
70292127	G 1/2 - G 3/4	62	-	22	-	38	G1/2	G3/4	-	47	-	144	10	100

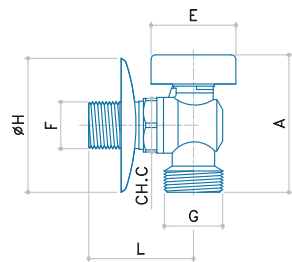

S 73

Ball angle valve for washing machine with butterfly handle and sliding collar.

CODE	SIZE	A	B	C	D	E	F	G	H	L	M			
70302127	G 1/2 - G 3/4	62	-	22	-	38	G1/2	G3/4	56	47	-	152	10	100

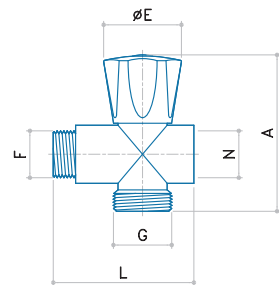

S 74

Intermediate screw-down angle valve with washing machine connection and 6-point handle.

CODE	SIZE	A	E	F	G	L	N			
70312100	G 1/2 - G 1/2 (intermediate) G 3/4 (washing machine connection)	70	35	G1/2	G3/4	63	G1/2	174	10	100

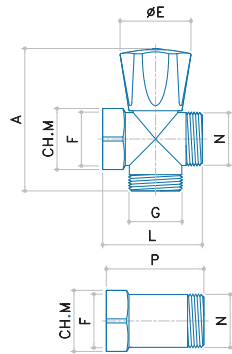

S 75

Intermediate screw-down angle valve with washing machine connection, 6-point handle and spacer.

CODE	SIZE	A	B	E	F	G	H	L	M	N	P			
70370000	G 3/4	70	-	35	G3/4	G3/4	-	49	30	G3/4	48	230	10	-

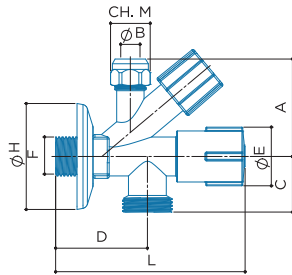

S 76

Double outlet screw-down angle valve with washing machine connection, sliding collar and 3-piece cartridge.

CODE	SIZE	A	B	C	D	E	F	G	H	L	M			
70402101CC	G 3/4 - G 3/8 - G 1/2	53	10	28	49	31	G1/2	G3/4	56	100	19	236	5	50

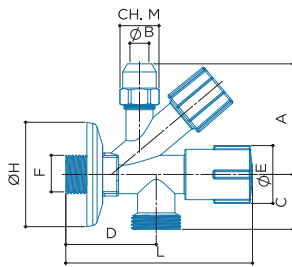

S 77

Double outlet screw-down angle valve with washing machine connection, sliding washer and 3-piece high nut cartridge.

CODE	SIZE	A	B	C	D	E	F	G	H	L	M			
70402102CC	G 3/4 - G 3/8 - G 1/2	61	10	28	49	31	G1/2	G3/4	56	100	19	244	5	50

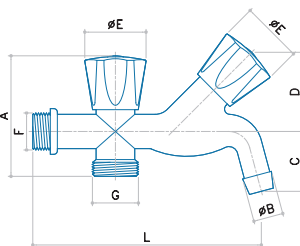

S 78

Double outlet screw-down angle valve with washing machine connection.

CODE	SIZE	A	B	C	D	E	F	G	H	L	M			
70162100	G 1/2 - G 3/4	69	17	34	45	35	G1/2	G3/4	-	130	-	376	6	-

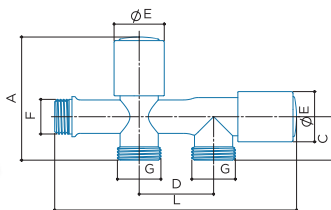

S 79

Double outlet screw-down angle valve with connection for washing machine and dishwasher.

CODE	SIZE	A	B	C	D	E	F	G	H	L	M			
70382100	G 1/2 - G 3/4 - G 3/4	74	-	26	45	30	G1/2	G3/4	-	144	-	296	6	-

RCC CARTRIDGE

The RCC cartridge is the safest and most practical solution for connecting angle valves to end users. As the three components are combined into a single body, the RCC cartridge is the definitive solution to the problems of installing compression fittings. No more lost or incorrectly assembled components, but a single piece that guarantees an excellent mechanical and hydraulic seal at the same time.

The cartridge is composed of a compression washer in CW614N annealed brass with excellent mechanical malleabil-

ity, an NBR seal and a high-toughness, impact-resistant nylon containment capsule. The limescale filter is made of weather-proof and oxidation-resistant AISI 304 stainless steel.

The special inspection cap has a convenient notch to facilitate opening/closing and to simplify filter cleaning. The ergonomic handle is made of ABS with a chrome finish and has strong mechanical properties that allow it to withstand the tensile, torsion and impact stresses which the angle valve may be subjected to during normal use.

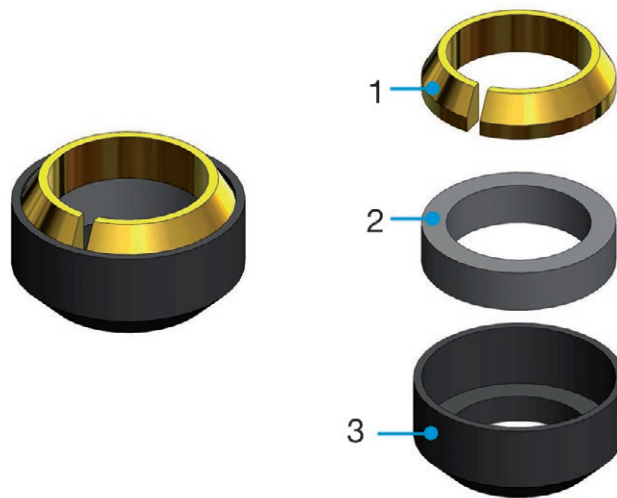

1. 2. Compression washer in CW614N brass

The brass washer has excellent mechanical properties due to the annealing process which improves the malleability of the material, ensuring correct coupling between the fitting and the pipe without exerting excessive tightening force.

2. NBR internal seal

Range of use for temperatures up to 90°C:

NBR seals have good mechanical properties, low permanent deformation and low gas permeability.

3. External Nylon Cartridge (Polyamide 6.6)

For use at temperatures up to 90 °C: the Nylon cartridge has excellent mechanical strength coupled with high toughness and impact resistance.

FLOW RATE DIAGRAM

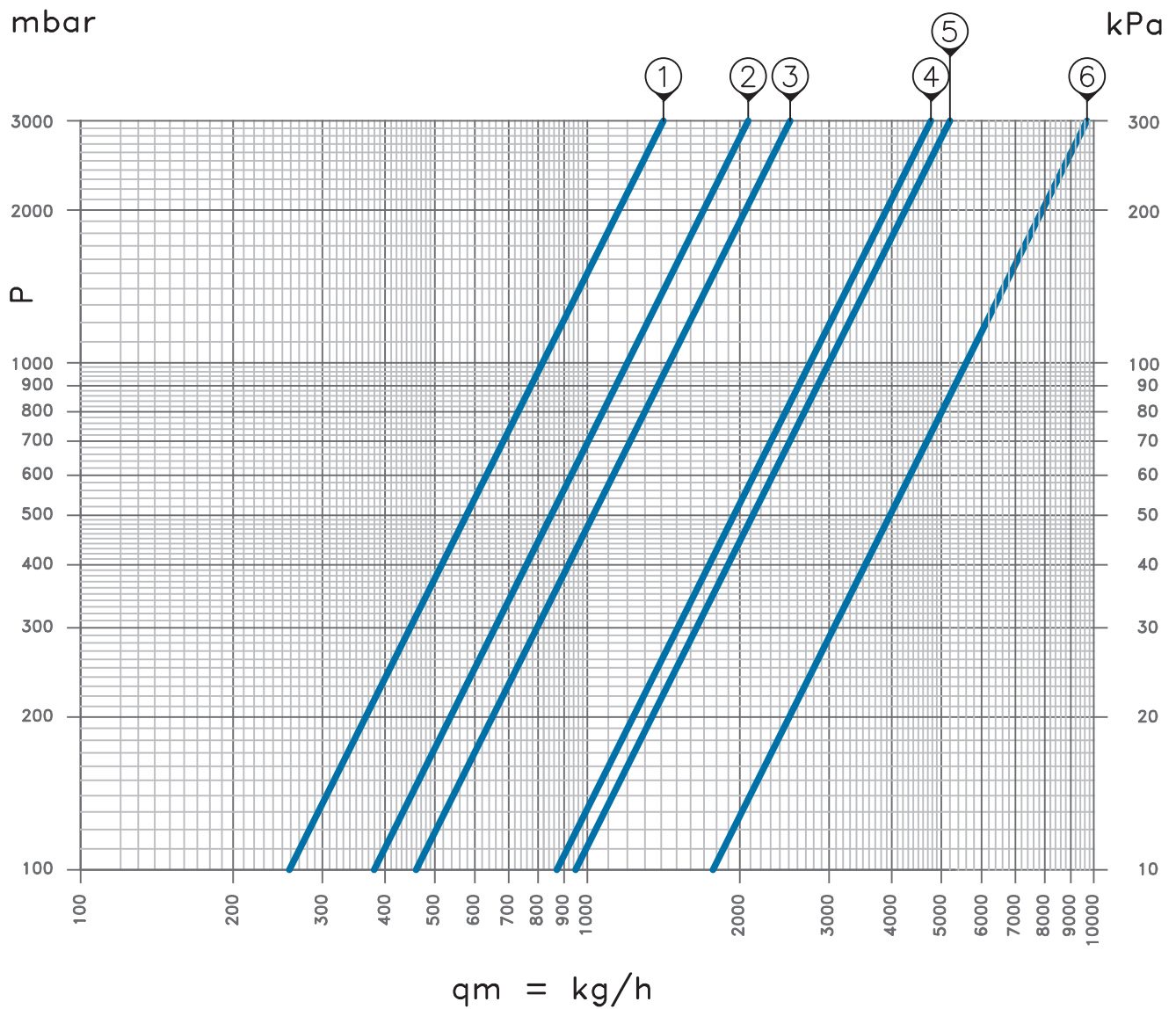

ARTICLES	CODE	ELBOW	Kv
S 70	70352105	1	0,85
S 71	70352102		
S 76	70402101CC	2	1,20
S 77	70402102CC		
S 72	70292127	3	1,55
S 73	70302127		
S 74	70312100	4	2,75
S 79	70382100		
S 78	70162100	5	3,00
S 75	70370000	6	5,60



ANGLE VALVES



6.7 / ACCESSORIES

ACCESSORIES



ROUND ROD FLOAT ANGLE VALVES



Heavy duty brass float angle valve, 5 split pins.

CODE	SIZE			
65041700	G 3/8	146	10	-
65042100	G 1/2	168	10	-



FLAT ROD FLOAT ANGLE VALVES

Heavy duty brass float angle valve, 5 cotter pins.

CODE	SIZE			
65012700	G 3/4	271	1	50
65013400	G 1"	410	1	50
65074200	G 1"1/4	1058	-	10
65074800	G 1"1/2	1385	-	10
65076000	G 2"	1872	-	5



SILENT FLOAT ANGLE VALVES



Silent, adjustable brass float angle valve with plastic valve seat and tube.

CODE	SIZE			
65091700	G 3/8	154	10	-
65092100	G 1/2	182	10	-



FLOAT ANGLE VALVES WITH STAINLESS STEEL VALVE SEAT FLOATING



Brass float angle valve with stainless steel valve seat and plastic pipe tested at 9 bar pressure.

CODE	SIZE			
65131700	G 3/8	152	10	-
65132100	G 1/2	182	10	-



HIGH PRESSURE FLOAT ANGLE VALVES

Adjustable brass float angle valve, for high pressure (12 bar), with flat rod and plastic tube.

CODE	SIZE			
65122700	G 3/4	926	-	30
65123400	G 1"	980	-	30
65124200	G 1"1/4	1834	-	10
65124800	G 1"1/2	1880	-	10
65126000	G 2"	3030	-	5



JOINT AND LOW NUT

3/8 joint with low nut.

CODE	SIZE			
05210000CC	G 1/2 - G 3/8 Ø 10	56	30	-



JOINT AND HIGH NUT

3/8 joint with high nut.

CODE	SIZE			
05220000CC	G 1/2 - G 3/8 Ø 10	62	30	-



FLAT SPHERE

Plastic ball with thread for round rod attachment.

CODE	SIZE			
65150000	-	34	10	50



ROUND SPHERE

Plastic ball with sliding attachment for flat rod.

CODE	SIZE			
65160001	Ø 120	82	5	20
65160002	Ø 180	214	1	10

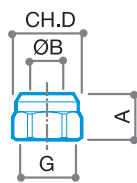

NUT

Chrome-plated brass nut for compression fittings.

CODE	FITTINGS	A	B	C	D	E	F	G	H	L			
76171000CF	3/8 - Ø 10	14	10	-	19	-	-	G 3/8	-	-	12	50	-
76171200CF	3/8 - Ø 12	14	12	-	19	-	-	G 3/8	-	-	12	50	-
76211000CF	1/2 - Ø 10	15	10	-	23	-	-	G 1/2	-	-	23	50	-
76211200CF	1/2 - Ø 12	15	12	-	23	-	-	G 1/2	-	-	21	50	-
76211400CF	1/2 - Ø 14	15	14	-	23	-	-	G 1/2	-	-	19	50	-

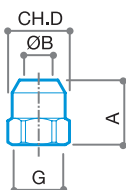



HIGH NUT

Chrome-plated brass high nut for compression fittings.

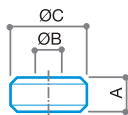
CODE	FITTINGS	A	B	C	D	E	F	G	H	L			
76171001CF	3/8 - Ø 10	22	10	-	19	-	-	G 3/8	-	-	18	50	-



**TEFLON OGIVE**

Sealing gasket for compression fittings.

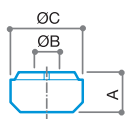
CODE	FITTINGS	A	B	C	D	E	F	G	H	L			
77171000CF	3/8 - Ø 10	6,5	10	14,5	-	-	-	-	-	-	1	100	-
77171200CF	3/8 - Ø 12	7	12	14,5	-	-	-	-	-	-	2	100	-
77211000CF	1/2 - Ø 10	7,5	10	18,5	-	-	-	-	-	-	1	100	-
77211200CF	1/2 - Ø 12	7,5	12	18,5	-	-	-	-	-	-	2	100	-
77211400CF	1/2 - Ø 14	7,5	14	18,5	-	-	-	-	-	-	2	100	-



**LOW 3-PIECE CARTRIDGE**

Sealing gasket for compression fittings.

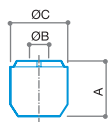
CODE	FITTINGS	A	B	C	D	E	F	G	H	L			
77171002CF	3/8 - Ø 10	8	10	14,5	-	-	-	-	-	-	1	100	-



**HIGH 3-PIECE CARTRIDGE**

Sealing gasket for high nut compression fittings.

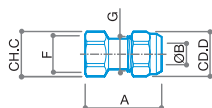
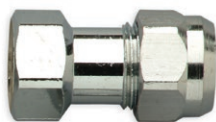
CODE	FITTINGS	A	B	C	D	E	F	G	H	L			
77171003CF	3/8 - Ø 10	14	10	14,5	-	-	-	-	-	-	2	100	-



**CHROMED EXTENSION**

Female brass compression extension fitting with 3-piece cartridge.

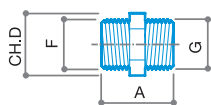
CODE	FITTINGS	A	B	C	D	E	F	G	H	L			
05160000CC	F 3/8 - RCC 3/8	40	10	19	19	-	G 3/8	G 3/8	-	-	40	30	-



**CHROME-PLATED NIPPLE FITTING**

Male-Male brass fitting.

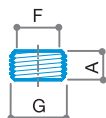
CODE	FITTINGS	A	B	C	D	E	F	G	H	L			
55021700	M 3/8 x M 3/8	31	-	-	17	-	G 3/8	G 3/8	-	-	31	25	-
55022100	M 1/2 x M 1/2	28	-	-	21	-	G 1/2	G 1/2	-	-	36	25	-

**REDUCTION**

Male-Female brass reduction.

CODE	FITTINGS	A	B	C	D	E	F	G	H	L			
55051700	M 1/2 x F 3/8	10	-	-	-	-	G 3/8	G 1/2	-	-	4	100	-
55052100	M 3/4 x F 1/2	11	-	-	-	-	G 1/2	G 3/4	-	-	14	100	-

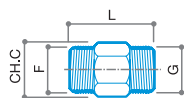

CHROME-PLATED EXTENDED NIPPLE FITTING

Male-Male brass fitting.

CODE	FITTINGS	A	B	C	D	E	F	G	H	L			
05331721	MP 1/2 x M 3/8	-	-	17	-	-	G 1/2	G 3/8	-	38	50	25	-
05332121	MP 1/2 x M 1/2	-	-	21	-	-	G 1/2	G 1/2	-	38	52	25	-

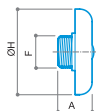

CAP WITH WASHER

Brass cap with ø 55 mm cover washer and fixing screw.

CODE	FITTINGS	A	B	C	D	E	F	G	H	L			
55072100	M 1/2	23	-	-	-	-	G 1/2	-	55	-	55	20	200

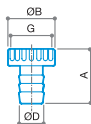

SWIVEL

Swivel ring nut with nickel-plated brass hose barb.

CODE	FITTINGS	A	B	C	D	E	F	G	H	L			
55271500	F 3/4	33	28	-	15	-	-	G 3/4	-	-	24	25	-
55342000	F 1"	40	35	-	20	-	-	G 1"	-	-	38	20	-

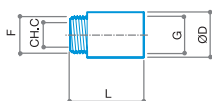

CHROMED M-F EXTENSION

Male-Female chrome-plated polished brass extension.

CODE	FITTINGS	A	B	C	D	E	F	G	H	L			
55062110	M 1/2 - F 1/2	-	-	13	24	-	G 1/2	G 1/2	-	20	26	50	-
55062115	M 1/2 - F 1/2	-	-	13	24	-	G 1/2	G 1/2	-	25	32	50	-
55062120	M 1/2 - F 1/2	-	-	13	24	-	G 1/2	G 1/2	-	30	38	50	-
55062125	M 1/2 - F 1/2	-	-	13	24	-	G 1/2	G 1/2	-	35	46	25	-
55062130	M 1/2 - F 1/2	-	-	13	24	-	G 1/2	G 1/2	-	40	52	25	-
55062140	M 1/2 - F 1/2	-	-	13	24	-	G 1/2	G 1/2	-	50	68	25	-
55062150	M 1/2 - F 1/2	-	-	13	24	-	G 1/2	G 1/2	-	60	82	25	-

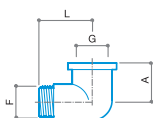

CHROME-PLATED 90° M-F ELBOW

Chrome-plated polished brass Male-Female elbow.

CODE	FITTINGS	A	B	C	D	E	F	G	H	L			
55131700	M 3/8 - F 3/8	24	-	-	-	-	G 3/8	G 3/8	-	30	58	25	-
55132100	M 1/2 - F 1/2	24	-	-	-	-	G 1/2	G 1/2	-	33	68	25	-
55132700	M 3/4 - F 3/4	30	-	-	-	-	G 3/4	G 3/4	-	41	132	10	-
55133400	M 1" - F 1"	39	-	-	-	-	G 1"	G 1"	-	51	268	10	-

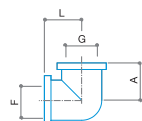

CHROME-PLATED 90° F-F ELBOW

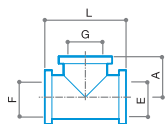

Chrome-plated polished brass Female-Female elbow.

CODE	FITTINGS	A	B	C	D	E	F	G	H	L			
55151700	F 3/8 - F 3/8	23	-	-	-	-	G 3/8	G 3/8	-	23	48	25	-
55152100	F 1/2 - F 1/2	24	-	-	-	-	G 1/2	G 1/2	-	24	68	25	-
55152700	F 3/4 - F 3/4	24	-	-	-	-	G 3/4	G 3/4	-	24	112	10	-
55153400	F 1" - F 1"	35	-	-	-	-	G 1"	G 1"	-	35	168	10	-



CHROME-PLATED T-FITTING

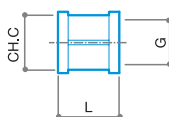

3-way chrome-plated brass fitting.

CODE	FITTINGS	A	B	C	D	E	F	G	H	L			
55171700	F 3/8	24	-	-	-	G 3/8	G 3/8	G 3/8	-	48	102	25	-
55172100	F 1/2	24	-	-	-	G 1/2	G 1/2	G 1/2	-	47	98	25	-
55172700	F 3/4	25	-	-	-	G 3/4	G 3/4	G 3/4	-	49	108	10	-
55173400	F 1"	35	-	-	-	G 1"	G 1"	G 1"	-	67	264	10	-



CHROME-PLATED F-F SLEEVE

Polished chrome-plated brass
Female-Female fitting.

CODE	FITTINGS	A	B	C	D	E	F	G	H	L			
55191700	F 3/8-F 3/8	-	-	-	-	-	-	G 3/8	-	31	40	25	-
55192100	F 1/2-F 1/2	-	-	24	-	-	-	G 1/2	-	27	44	25	-
55192700	F 3/4-F 3/4	-	-	30	-	-	-	G 3/4	-	33	66	10	-
55193400	F 1"-F 1"	-	-	37	-	-	-	G 1"	-	250	90	10	-

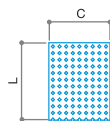

STAINLESS STEEL FILTER

Stainless steel filter for Luxor
undersink ball angle valves.

CODE	FITTINGS	A	B	C	D	E	F	G	H	L			
2903015CF	Ø 13,8	-	-	13,8	-	-	-	-	-	17,5	0,4	50	-