



**LUXOR<sup>®</sup>**

**FLEXIBLE HOSES**

## FLEXIBLE HOSES



Luxor's Flexible hoses are first rate Made in Italy products, reliable and top quality products worldwide renowned.

The excellent mechanical and hygienic features, the easiness of their installation and the good value of this product find a continuously increasing appreciation by installers and merchants. The constant attention given to the market demands, to customers' requirements and to the hygienic and environmental obligations, make Luxor's flexible hoses a clear point of reference in the sanitary-plumbing market.

Luxor's flexible hoses are the ideal solution for any type of installation for the distribution of sanitary and drinking water: reliable, easy to fit, cost effective. Luxor's industrial manufacturing process represents the state of the art for the high technology of the production machinery which guarantee a perfect production in every single step.

The hoses are thoroughly checked through severe quality controls, including high resolution photo-camera devices which can detect 100% any possible fault occurred during the production process.

Luxor's Company's Quality System and Luxor's flexible hoses are approved and certified by the most important International Institutes, which recognize and appreciate, besides the product technical qualities, also the Company's policy clearly addressed towards the customer's satisfaction and to the accomplishment to the rules requirements compulsory to the manufactured goods.



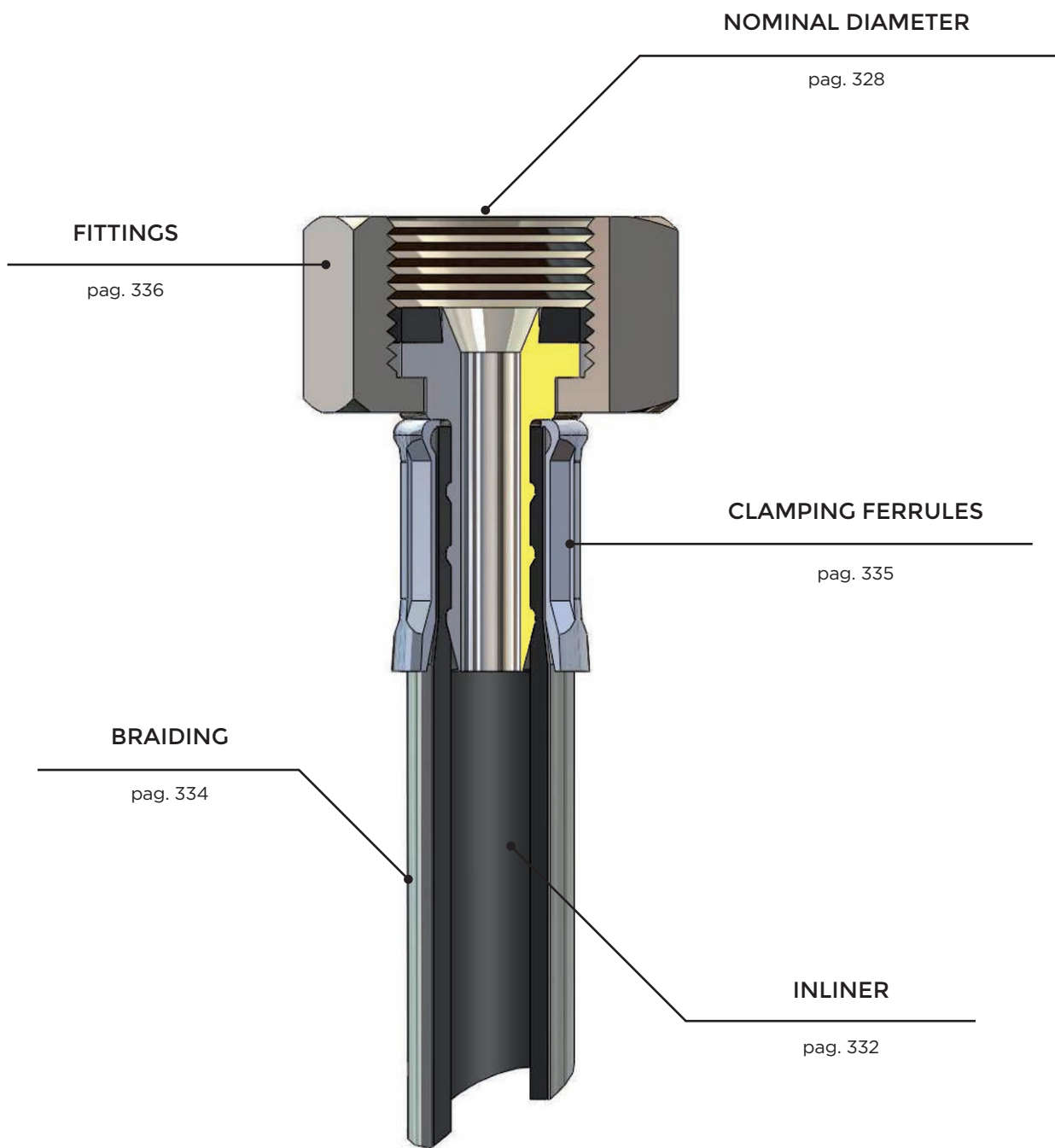

**APPLICATIONS**

pag. 330

**APPROVALS**

pag. 340

**ASSEMBLY INSTRUCTIONS**

pag. 438

**LENGTH INSTRUCTIONS**































pag. 440

## NOMINAL DIAMETER



Luxor Spa's range of hoses comprises products which comply with the most prominent international standards and the current European norm EN13618:2017.

The table below shows the most relevant technical features for every nominal diameter, as well as the availability with silicone, TP, EPDM, PEX and butyl inliner.

Inliner Range	Nominal Diameter	Inner ø mm	Outer ø mm	Min bending radius	Inner fittings ø mm	Flow rate at 3 bar	Max working pressure	Max working temperature	Min working temperature	Available Fittings	Available Braiddings
											
   	DN6	6,3	10	40	4,7	16 l/min	10 Bar	70° C	-5° C	Brass, stainless steel, plastic	Stainless steel, nylon PA 6.6
 	DN8	8,5	12	48	6,2	28 l/min	10 Bar	70° C	-5° C	Brass, stainless steel, plastic	Stainless steel, nylon PA 6.6
	DN8	8,5	12,5	48	6,2	28 l/min	10 Bar	90° C	-20° C	Brass	Stainless steel
 	DN10	9,4	13	56	7,5	46 l/min	10 Bar	70° C	-5° C	Brass, copper, stainless steel, plastic	Stainless steel, nylon PA 6.6
	DN10	9,4	14	56	7,5	46 l/min	10 Bar	90° C	-20° C	Brass	Stainless steel
  	DN13	12,5	18	72	10	74 l/min	10 Bar	70° C	-5° C	Brass, copper, stainless steel, plastic	Stainless steel, nylon PA 6.6
	DN13	12,5	18	72	10	74 l/min	10 Bar	90° C	-20° C	Brass	Stainless steel
	DN15	15	20	80	12,5	83 l/min	10 Bar	110° C	-5° C	Brass, copper, stainless steel, galvanised steel	Stainless steel, galvanised steel
	DN15	15	20	80	12,5	83 l/min	10 Bar	90° C	-20° C	Brass	Stainless steel
 	DN18	19	26	104	15,5	200 l/min	10 Bar	110° C	-5° C	Brass, copper, stainless steel, galvanised steel	Stainless steel, galvanised steel
	DN18	19	26	104	15,5	200 l/min	10 Bar	90° C	-20° C	Brass	Stainless steel
 	DN25	25,5	33	132	21	280 l/min	10 Bar	110° C	-5° C	Brass, copper, stainless steel, galvanised steel	Stainless steel, galvanised steel
	DN25	25,5	33	132	21	280 l/min	10 Bar	90° C	-20° C	Brass	Stainless steel
 	DN32	32	42	168	27	490 l/min	6 Bar	110° C	-5° C	Brass, stainless steel, galvanised steel	Stainless steel, galvanised steel
	DN32	32	42	168	27	490 l/min	6 Bar	90° C	-20° C	Brass	Stainless steel
	DN40	40	53	212	32	800 l/min	6 Bar	110° C	-5° C	Brass, stainless steel, galvanised steel	Stainless steel, galvanised steel
	DN50	50	65	275	41	1300 l/min	6 Bar	110° C	-5° C	Brass, stainless steel, galvanised steel	Stainless steel, galvanised steel

 Silicone  EPDM  Thermoplastic  PEX  Butyl

Please contact our technical department for further information

### FLOW RATE CHARTS

Flow capacity diagram on hoses with straight fittings, length 1400 mm.

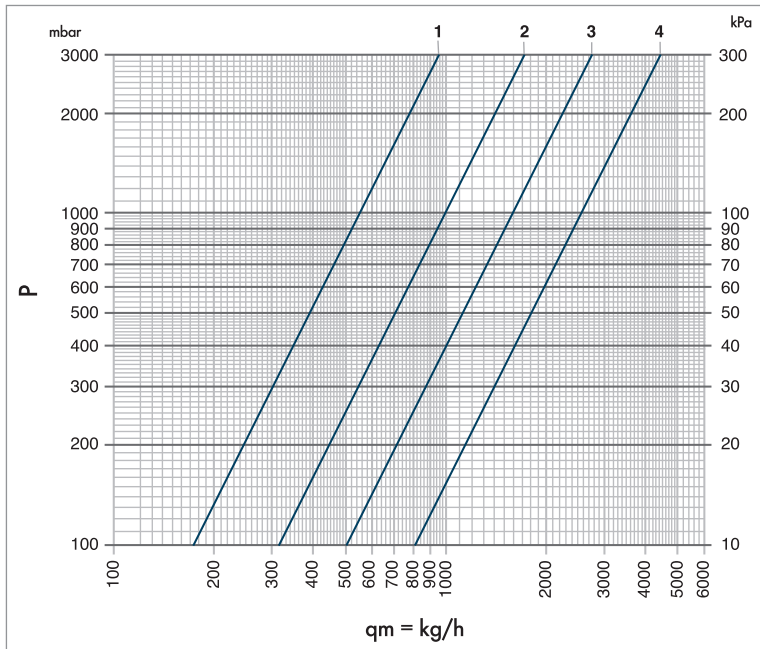

HOSE DIMENSIONS	POS	Kv	Flow l/min con ΔP 3 bar
DN 6	1	0,55	16
DN 8	2	0,97	28
DN 10	3	1,59	46
DN 13	4	2,56	74

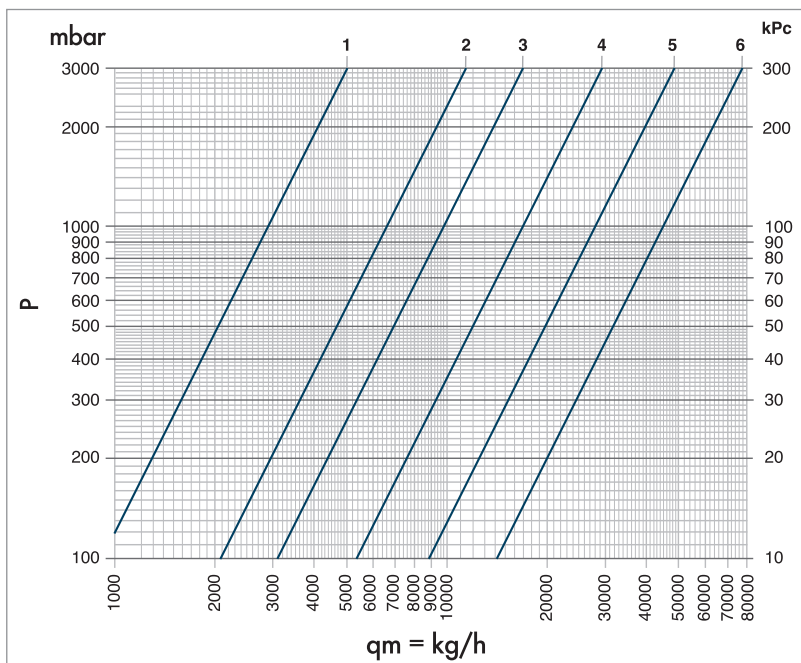

HOSE DIMENSIONS	POS	Kv	Flow l/min con ΔP 3 bar
DN 15	1	2,9	83
DN 18	2	6,6	200
DN 25	3	9,8	280
DN 30	4	17	490
DN 40	5	28	800
DN 50	6	45	1300

## APPLICATIONS

Luxor Spa's flexible hoses are the ideal solution for every application, both sanitary and industrial. They are safe and easy to install.

The table below shows some of the most common applications, as well as the availability with silicone, TP, EPDM, PEX and butyl inliner.



traditional taps



mixers



heating systems



flushing tanks



boilers



kitchen pull-out shower



generic installations

conditioning systems /  
fan coil

washing machines



mounting columns



water heaters



dishwasher



shower cabins

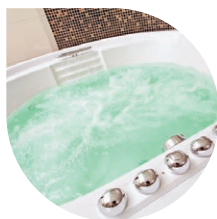

whirlpools



pumps



coffee machines

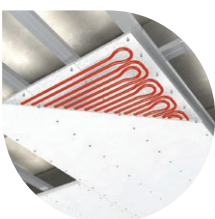

radiant ceiling panels

Inliner Range	Nominal diameter	Single-lever mixer taps	Two-handle faucets	Mixers	Pull-out shower faucets	Single-hole mixer taps	Coffee machines	Cisterns	Water installations	Sanitary systems	Boilers	Inlet hoses	Water meters	Whirlpools	Shower cubicles	Fancoils	Heating systems	Pumps	Autoclaves	Heat pumps	Air-conditioning systems	Greenhouses	Risers	Common installations	Radiant ceiling panels
	DN6	●		●			●																		
	DN8	●	●	●	●	●	●	●	●	●	●					●	●				●				●
	DN10		●						●	●	●	●				●	●				●				●
	DN13								●		●	●	●	●	●	●	●				●				●
	DN15										●						●	●	●	●	●	●	●	●	●
	DN18																●	●	●	●	●	●	●	●	●
	DN25																●	●	●	●	●	●	●	●	●
	DN32																●	●	●		●	●	●	●	●
	DN40																●	●	●			●	●	●	●
	DN50																●	●	●			●	●	●	●

## INLINER

---

### SILICONE

Silicone, a noble high-quality material, has gained growing recognition on sanitary markets at an international level.

It is the most hygienic material available on the market and guarantees complete purity. Outstanding elasticity and excellent mechanical properties throughout the temperature range exemplify its characteristics.



---

### THERMOPLASTIC

As the result of years of R&D of noble and high-performance materials, TP combines the purity and hygiene of PEX and silicone with the outstanding mechanical properties of EPDM. Flexibility, versatility and usability make Luxor TP hoses a high-quality product certified by the most prominent international institutes. Luxor TP hoses were developed in order to protect the end users' wellbeing and the environment by being hygienically pure and completely recyclable.



---

### EPDM

EPDM rubber is the most widespread inliner material. Available in various compounds, it shows excellent hygienic and mechanical characteristics as well as resistance to oxidation, environmental factors and high temperatures.

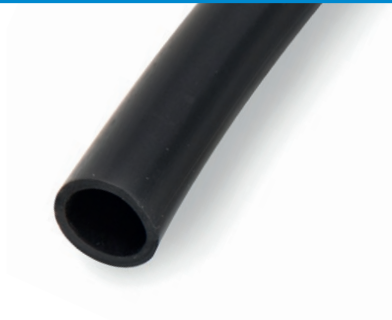

---

### PEX

PEX is a thermoplastic material endowed with excellent hygienic properties which does not affect the taste and smell of water throughout the temperature range. PEX hoses have established themselves on the market as a good alternative to EPDM.



---

### BUTYL

Butyl is a material with low oxygen permeability. This feature makes it suitable for all closed circuit applications where oxygen creates corrosion.

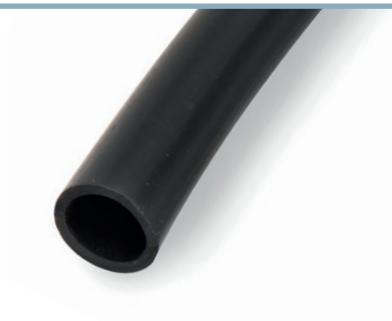





PROPERTIES	SILICONE	THERMOPLASTIC	EPDM	PEX	BUTYL
Hygienic Purity	●●●●●	●●●●	●●●	●●●●	-
Mechanical Resistance	●●●	●●●●	●●●●●	●●●	●●●
Resistance to Temperature	●●●●●	●●●●	●●●●●	●●	●●●
Durability	●●●●●	●●●●●	●●●●	●●●	●●●●●
Flexibility	●●●●●	●●●●●	●●●●	●	●●●
Approvals	●●●●●	●●●●●	●●●	●●●	-
Range	●●●●	●●●	●●●●●	●	●●●●
Versatility	●●●●●	●●●	●●●●●	●	●

● Sufficient    ●● Discrete    ●●● Good    ●●●● Very Good    ●●●●● Excellent

## BRAIDING

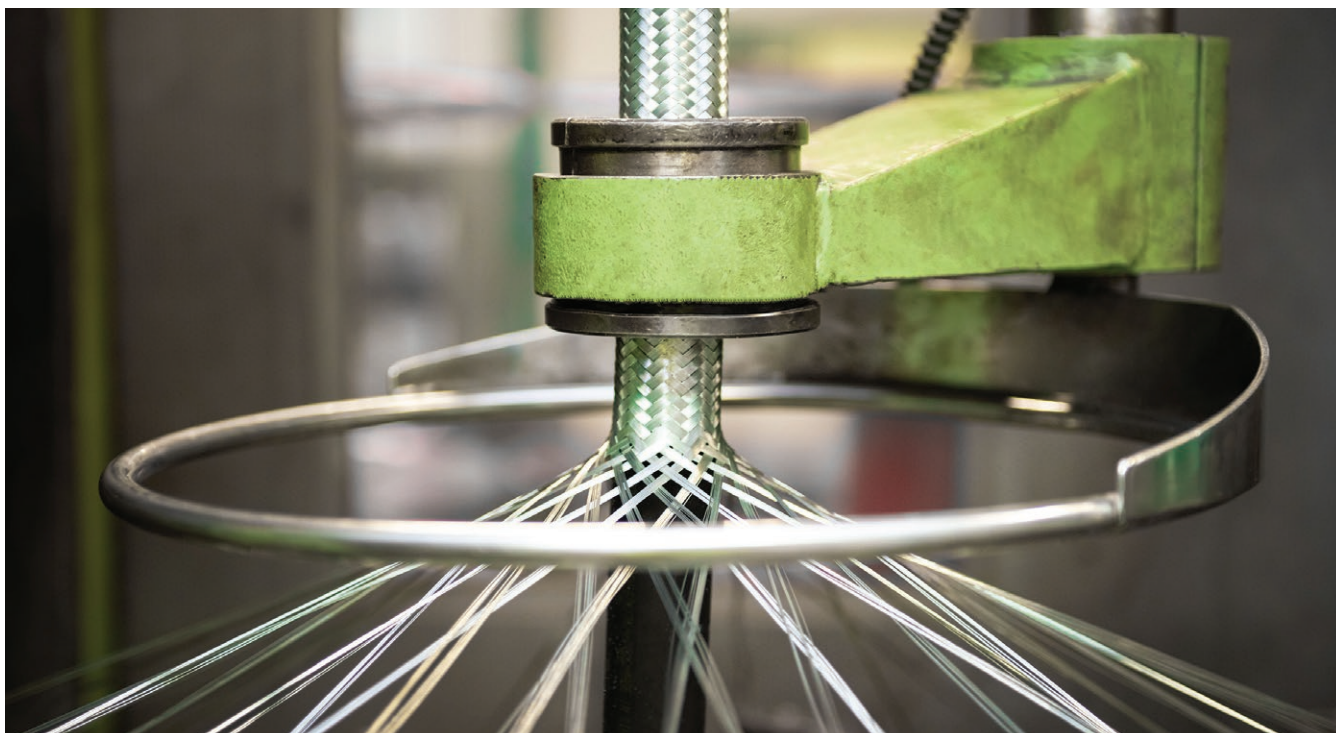

The external reinforcing braiding is made using stainless steel threads AISI 304  $\varnothing$  0,20 mm,  $\varnothing$  0,22 mm, galvanized steel threads  $\varnothing$  0,30 mm and Nylon threads PA 6.6  $\varnothing$  0,25 mm and  $\varnothing$  0,30 mm.

These threads, joined to become plaits are assembled so to cover completely the inner pipe giving to the flexible hose the faculty to sustain the normal working pressure and the possible overpressure which can occur during an ordinary performance of the hydraulic system.

**STAINLESS STEEL THREADS**

The stainless steel threads have a minimum  $\varnothing$  0,20 mm, a higher dimension of the one normally employed by other producers, so to guarantee a safe and reliable top quality product. Thanks to this excellent covering material, Luxor's flexible hoses have successfully passed the most severe mechanical tests of European and International Certification Institutes of the hydrosanitary field.

**NYLON THREADS**

The Nylon PA 6.6 threads also assure excellent resistance

and good mechanical qualities thanks to the elasticity of material and the good performance at high and low temperature. Flexible hoses with braiding in Nylon PA 6.6 have found a large market in the kitchen mixers with pull-out showers for example, due to their good performance and their resistance to the wear and tear due to the friction rub and to the low noise produced during the normal daily use.

**BRAIDING**

The braiding percentage of covering can change in accordance to the specific product requests and to the customer's requirements, going from a 97% cover until 80%.

The 97% braiding covers perfectly the inner pipe making the flexible hose mechanically more resistant to the strains and giving a better aesthetic exterior.

The thread dimension, the quality of the material and the covering percentage of the braiding distinguish Luxor's hoses, products with a high quality profile, from those of other producers.



## CLAMPING FERRULES

The clamping ferrules of the end connectors are in stainless steel AISI 304 (from DN6 to DN50) and in aluminium (from DN15 to DN50), materials firm and safe, which differing from brass, are not subjects to breakage given by stress corrosion.

Next to the peculiar specific qualities of the stainless steel, that is the resistance to corrosion and oxidation, the stainless steel clamping ferrules AISI 304 are solubilized so to stress relieve and reduce the superficial hardness of the material and avoid the possible development of splits during the pressing process.

### PRESSURE

The pressure of the clamping ferrules to the braided hose

and to the end connectors is made with an octagonal pressing process.

For special dimensional requirements is carried out a double pressing called "calibration" which allows a further external space reduction of the clamping ferrules.

### IDENTIFICATION MARK

All Luxor's flexible hoses are clearly and rigorously marked with an identification mark on the clamping ferrules bearing the mark LUX, year of production and the technical-regulation quotes.

By marking the hose each producer assumes his responsibility of what is produced: **BEWARE OF HOSES WITH NO NAME!**



## FITTINGS



The end connectors are produced in brass CW617N and CW614N with low lead content in compliance to the recent rules UNI EN12165 and UNI EN12164.

For some markets, or for some particular applications, are also available fittings in brass CW602N, which differs from the commonly used brass, since it prevents the brass from dezincification caused by the loss of zinc and the consequent redeposit of copper.

Though the percentage of lead within the brass alloys for the fittings are low and guaranteed by the European regulation, the new challenge that producers of plumbing material are facing is the total exclusion of lead from the manufactured products. With the main target to constantly improve the hygienic quality of the product and to improve the pureness of the materials, Luxor is engaged to use for particular markets brass Ecobrass type with zero percentage of lead.

The fittings, based on the specific markets demands or on product certification requirement, undergo further manufacturing processes such as: normalization (to stress relieve the material and reduce the surface hardness and avoid the occurring of production cracks).

For particular application, where high resistance to oxidation and good resistance to mechanical stress is required,

the fittings are produced in stainless steel AISI304.

Other fittings are produced in deoxidated phosphor copper Cu-DHP quality with chemical composition: Cu 99,9% min, whose mechanical qualities, dimensions and tolerances are in compliance to the EN1057 rule and its connected regulations.

For particular requirements and for those markets less demanding are also available end connectors in steel AVP.

### SEALING GASKETS AND O-RINGS

The water tightness of the end connectors is guaranteed by the use of gaskets and o-rings in EPDM and NBR, materials with high ozone free properties, which preserve their tightening features and mechanical resistance throughout times.

The compounds used, thanks to the excellent hygienic properties, are fit for drinking water adduction, and have been approved by the most rigorous Certification Institutes of the hydrosanitary field.

The mechanical, physical and hygienic qualities of the gaskets and o-rings are constantly tested with specific laboratory tests both carried out internally or externally to verify their conformity to the rules requirements.



### TYPE OF FITTINGS

Luxor's main target is that to satisfy the customer during the development process of the new products and give new technical solutions.











Inliner Range	Nominal Diameter								
<ul style="list-style-type: none"> <li><span style="color: green;">●</span> Silicone</li> <li><span style="color: blue;">●</span> EPDM</li> <li><span style="color: purple;">●</span> Thermoplastic</li> <li><span style="color: orange;">●</span> PEX</li> </ul>	<b>DN6</b>	<b>Short male</b> M 8x1 - 18 mm M 10x1 - 18 mm M 11x1 - 20 mm		<b>Medium male</b> M 8x1 - 44 mm M 10x1 - 44 mm		<b>Long male</b> M 8x1 - 74 mm M 10x1 - 74 mm		<b>Smooth Pipe</b> ø 10 mm	
		<b>Safety end Pipe</b> ø 8 mm ø 10 mm		<b>Female without gasket</b> G 1/4 - G 3/8 - G 1/8 G 1/2 - M 10x1 M 15x1 M 12x1 - 9/16 - 24 unef		<b>Collar</b> G 1/2		<b>Male</b> G 1/8 G 3/8 G 1/2	
		<b>Swivel Male</b> M 12x1 M 15x1 G 3/8		<b>Female with gasket</b> G 3/8 - G 1/2 M 10x1 - M 15x1 9/16 - 24 unef					

Inliner Range	Nominal Diameter								
<ul style="list-style-type: none"> <li><span style="color: green;">●</span> Silicone</li> <li><span style="color: blue;">●</span> EPDM</li> <li><span style="color: purple;">●</span> Thermoplastic</li> <li><span style="color: orange;">●</span> PEX</li> <li><span style="color: teal;">●</span> Butyl</li> </ul>	<b>DN8</b>	<b>Short male</b> M 10x1 - 18 mm M 11x1 - 19 mm M 12x1 - 19 mm		<b>Medium male</b> M 10x1 - 46 mm M 12x1 - 43 mm		<b>Long male</b> M 10x1 - 74 mm M 12x1 - 75 mm		<b>Smooth Pipe</b> ø 10 mm ø 15 mm	
		<b>Safety end Pipe</b> ø 10 mm		<b>Male</b> G 1/4 G 3/8 G 1/2 G 3/4		<b>Female without gasket</b> G 1/4 - G 3/8 - G 1/2 G 3/4 - M 15x1		<b>Elbow Female without gasket</b> G 1/4 - G 3/8 G 1/2 - G 3/4	
		<b>Compressor Fitting</b> ø 10 mm ø 12 mm ø 14 mm ø 15 mm		<b>Swivel Male</b> M 15x1 G 3/8 G 1/2		<b>Collar</b> G 1/2		<b>Female with o-ring</b> G 3/8	
		<b>Elbow Female with o-ring</b> G 3/8		<b>Female with gasket</b> G 3/8 - G 1/2 G 3/4 - 1/2 NPSM 9/16 - 24 unef		<b>Elbow Female with gasket</b> G 3/8 - G 1/2 G 3/4		<b>Extended Male</b> G 3/8 - 26 mm G 1/2 - 28 mm	
		<b>Push-Fit Fitting</b> ø 8							





● Silicone  
 ● EPDM  
 ● Thermoplastic  
 ● PEX  
 ● Butyl

Please contact our technical department for further information

Inliner Range	Nominal Diameter							
<ul style="list-style-type: none"> <li><span style="color: blue;">●</span> EPDM</li> <li><span style="color: purple;">●</span> Thermoplastic</li> <li><span style="color: teal;">●</span> Butyl</li> </ul>	<b>DN10</b>	<b>Short male</b> M 12x1 - 16 mm 	<b>Male</b> G 1/4 G 3/8 G 1/2 	<b>Female without gasket</b> G 3/8 G 1/2 G 3/4 	<b>Elbow Female without gasket</b> G 3/8 G 1/2 G 3/4 			
		<b>Compressor Fitting</b> ø 10 mm ø 12 mm ø 14 mm ø 15 mm 	<b>Wings Female with or without o-ring</b> G 1/2 	<b>Swivel Male</b> G 3/8 G 1/2 	<b>Brass Push-Fit</b> ø 12 			
		<b>Female with gasket</b> G 3/8 - G 1/2 G 3/4 	<b>Elbow Female with gasket</b> G 1/2 - G 3/4 	<b>Extended Male</b> G 3/8 - 26 mm G 1/2 - 28 mm 				

Inliner Range	Nominal Diameter							
<ul style="list-style-type: none"> <li><span style="color: green;">●</span> Silicone</li> <li><span style="color: blue;">●</span> EPDM</li> <li><span style="color: purple;">●</span> Thermoplastic</li> <li><span style="color: teal;">●</span> Butyl</li> </ul>	<b>DN13</b>	<b>Male</b> G 3/8 G 1/2 G 3/4 	<b>Female without gasket</b> G 3/8 G 1/2 G 3/4 	<b>Elbow Female without gasket</b> G 1/2 G 3/4 G 1" 	<b>Smooth Pipe</b> ø 15 mm 			
		<b>Safety end Pipe</b> ø 15 mm 	<b>Compressor Fitting</b> ø 12 mm ø 15 mm 	<b>Brass Push-Fit</b> ø 12 	<b>Female with gasket</b> G 1/2 - G 3/4 			
		<b>Elbow Female with gasket</b> G 1/2 - G 3/4 	<b>Extended Male</b> G 1/2 - 28 mm 					

Inliner Range	Nominal Diameter							
<ul style="list-style-type: none"> <li><span style="color: blue;">●</span> EPDM</li> <li><span style="color: teal;">●</span> Butyl</li> </ul>	<b>DN15</b>	<b>Male</b> G 1/2 G 3/4 	<b>Female</b> G 1/2 G 3/4 	<b>Elbow Female</b> G 1/2 G 3/4 	<b>Smooth Pipe</b> ø 15 mm 			

Inliner Range	Nominal Diameter								
<ul style="list-style-type: none"> <li><span style="color: green;">●</span> Silicone</li> <li><span style="color: blue;">●</span> EPDM</li> <li><span style="color: grey;">●</span> Butyl</li> </ul>	<b>DN18</b>	Male G 3/4 G 1"		Female G 3/4 G 1"		Elbow Female G 3/4 G 1"		Smooth Pipe ø 22 mm	

Inliner Range	Nominal Diameter								
<ul style="list-style-type: none"> <li><span style="color: green;">●</span> Silicone</li> <li><span style="color: blue;">●</span> EPDM</li> <li><span style="color: grey;">●</span> Butyl</li> </ul>	<b>DN25</b>	Male G 1"		Female G 1" G 1" 1/4 G 1" 1/2		Elbow Female G 1"		Smooth Pipe ø 28 mm	

Inliner Range	Nominal Diameter						
<ul style="list-style-type: none"> <li><span style="color: green;">●</span> Silicone</li> <li><span style="color: blue;">●</span> EPDM</li> <li><span style="color: grey;">●</span> Butyl</li> </ul>	<b>DN32</b>	Male G 1" 1/4		Female G 1" 1/4		Elbow Female G 1" 1/4	

Inliner Range	Nominal Diameter				
<ul style="list-style-type: none"> <li><span style="color: blue;">●</span> EPDM</li> </ul>	<b>DN40</b>	Male G 1" 1/2		Female G 1" 1/2	

Inliner Range	Nominal Diameter				
<ul style="list-style-type: none"> <li><span style="color: blue;">●</span> EPDM</li> </ul>	<b>DN50</b>	Male G 2"		Female G 2"	

## APPROVALS

Nominal Diameter									
DN6		Nation: Italy	Certification: DM 174		Nation: Australia	Certification: WATERMARK		Nation: Denmark	Certification: VA
		Inliner Range:			Inliner Range:			Inliner Range:	
		Nation: France	Certification: QB		Nation: Germany	Certification: DVGW		Nation: Norway	Certification: SINTEF
		Inliner Range:			Inliner Range:			Inliner Range:	
		Nation: Holland	Certification: KIWA		Nation: Switzerland	Certification: SVGW		Nation: Sweden	Certification: RISE
		Inliner Range:			Inliner Range:			Inliner Range:	
		Nation: USA	Certification: NSF - IAPMO		Nation: UE	Certification: EN 13618		Nation: UK	Certification: WRAS
		Inliner Range:			Inliner Range:			Inliner Range:	

Nominal Diameter									
DN8		Nation: Italy	Certification: DM 174		Nation: Australia	Certification: WATERMARK		Nation: Denmark	Certification: VA
		Inliner Range:			Inliner Range:			Inliner Range:	
		Nation: France	Certification: QB		Nation: Germany	Certification: DVGW - TÜV		Nation: Norway	Certification: SINTEF
		Inliner Range:			Inliner Range:			Inliner Range:	
		Nation: Holland	Certification: KIWA		Nation: Switzerland	Certification: SVGW		Nation: Sweden	Certification: RISE
		Inliner Range:			Inliner Range:			Inliner Range:	
		Nation: USA	Certification: NSF - IAPMO		Nation: UE	Certification: EN 13618		Nation: UK	Certification: WRAS
		Inliner Range:			Inliner Range:			Inliner Range:	

● Silicone   
 ● EPDM   
 ● Thermoplastic   
 ● PEX

Please contact our offices for information about technical specifications and certified products or visit the website of the corresponding certification body for the latter. Please refer to [www.nsf.org](http://www.nsf.org) for a complete list of NSF approved products. Please refer to [www.iapmo.org](http://www.iapmo.org) for a complete list of UPC/cUPC approved products.



Nominal Diameter

DN10		Nation:  Italy Certification: DM 174 Inliner Range: ● ●		Nation:  Australia Certification: WATERMARK Inliner Range: ● ●		Nation:  Denmark Certification: VA Inliner Range: ●
		Nation:  France Certification: QB Inliner Range: ● ●		Nation:  Germany Certification: DVGW - TÜV Inliner Range: ● (TÜV) ● (DVGW)		Nation:  Norway Certification: SINTEF Inliner Range: ●
		Nation:  Holland Certification: KIWA Inliner Range: ●		Nation:  Switzerland Certification: SVGW Inliner Range: ●		Nation:  Sweden Certification: RISE Inliner Range: ●
		Nation:  USA Certification: NSF - IAPMO Inliner Range: ● ●		Nation:  UE Certification: EN 13618 Inliner Range: ● ●		Nation:  UK Certification: WRAS Inliner Range: ● ●

Nominal Diameter

DN13		Nation:  Italy Certification: DM 174 Inliner Range: ● ● ●		Nation:  Australia Certification: WATERMARK Inliner Range: ● ● ●		Nation:  Denmark Certification: VA Inliner Range: ● ●
		Nation:  France Certification: QB Inliner Range: ● ● ●		Nation:  Germany Certification: DVGW - TÜV Inliner Range: ● (DVGW - TÜV) ● (TÜV) ● (DVGW)		Nation:  Norway Certification: SINTEF Inliner Range: ● ●
		Nation:  Holland Certification: KIWA Inliner Range: ● ●		Nation:  Switzerland Certification: SVGW Inliner Range: ● ●		Nation:  Sweden Certification: RISE Inliner Range: ● ●
		Nation:  USA Certification: NSF - IAPMO Inliner Range: ● ● ●		Nation:  UE Certification: EN 13618 Inliner Range: ● ● ●		Nation:  UK Certification: WRAS Inliner Range: ● ● ●

- Silicone
- EPDM
- Thermoplastic
- PEX

Please contact our offices for information about technical specifications and certified products or visit the website of the corresponding certification body for the latter. Please refer to [www.nsf.org](http://www.nsf.org) for a complete list of NSF approved products. Please refer to [www.iapmo.org](http://www.iapmo.org) for a complete list of UPC/cUPC approved products.

Nominal Diameter

<b>DN15</b>		Nation: <b>France</b>		Nation: <b>Germany</b>	<b>EN 13618</b>	Nation: <b>UE</b>
		Certification: <b>QB</b>		Certification: <b>TÜV</b>		Certification: <b>EN 13618</b>
		Inliner Range:		Inliner Range:		Inliner Range:

Nominal Diameter

<b>DN18</b>		Nation: <b>France</b>		Nation: <b>Germany</b>	<b>EN 13618</b>	Nation: <b>UE</b>
		Certification: <b>QB</b>		Certification: <b>DVGW - TÜV</b>		Certification: <b>EN 13618</b>
		Inliner Range:		Inliner Range:  (DVGW - TÜV)  (TÜV)		Inliner Range:
		Nation: <b>UK</b>				
		Certification: <b>WRAS</b>				
		Inliner Range:				

Nominal Diameter

<b>DN25</b>		Nation: <b>France</b>		Nation: <b>Germany</b>	<b>EN 13618</b>	Nation: <b>UE</b>
		Certification: <b>QB</b>		Certification: <b>DVGW - TÜV</b>		Certification: <b>EN 13618</b>
		Inliner Range:		Inliner Range:  (DVGW - TÜV)  (TÜV)		Inliner Range:

Nominal Diameter

<b>DN32</b>		Nation: <b>France</b>		Nation: <b>Germany</b>
		Certification: <b>QB</b>		Certification: <b>DVGW - TÜV</b>
		Inliner Range:		Inliner Range:  (DVGW - TÜV)  (TÜV)

Nominal Diameter

<b>DN40</b>		Nation: <b>France</b>		Nation: <b>Germany</b>
		Certification: <b>QB</b>		Certification: <b>TÜV</b>
		Inliner Range:		Inliner Range:

Nominal Diameter

<b>DN50</b>		Nation: <b>France</b>		Nation: <b>Germany</b>
		Certification: <b>QB</b>		Certification: <b>TÜV</b>
		Inliner Range:		Inliner Range:

Silicone EPDM

Please contact our offices for information about technical specifications and certified products or visit the website of the corresponding certification body for the latter. Please refer to [www.nsf.org](http://www.nsf.org) for a complete list of NSF approved products. Please refer to [www.iapm.org](http://www.iapm.org) for a complete list of UPC/cUPC approved products.