



LUXOR[®]

CATALOGO GENERALE
LINEA TERMOSANITARIA

2024.1



60 ANNI DI TRADIZIONE ITALIANA

Luxor è una importante realtà industriale, market leader a livello europeo e mondiale nella produzione di tubi flessibili e di componenti per impianti idraulici e termosanitari.

Da sessant'anni Luxor è espressione del più prestigioso made in Italy e della grande tradizione italiana nelle lavorazioni meccaniche ad elevato contenuto tecnologico: una qualità certificata e riconosciuta dai più prestigiosi Istituti Internazionali di certificazione, ovunque nel mondo.

La nostra mission è la completa soddisfazione del cliente, mediante un processo di continua ricerca tecnologica volta a realizzare prodotti di assoluta qualità e totale affidabilità, anticipando le evoluzioni dei mercati all'interno di un innovativo rapporto di partnership sia verso i

clienti che verso i fornitori. La mission Luxor trova attuazione in un proprio Centro Ricerca & Sviluppo, nel quale vengono costantemente analizzate e ricercate nuove ed avanzate tecnologie, in continui investimenti per offrire ai mercati internazionali le soluzioni più avanzate ed affidabili a costi contenuti, nei più severi controlli qualitativi su ogni pezzo.

Luxor progetta e realizza globalmente, grazie al proprio ultra decennale know-how, ogni prodotto. La grande forza produttiva, un'organizzazione industriale "snella" innovativa ed avanzata, unitamente ad una moderna concezione logistica permettono a Luxor di soddisfare qualsiasi esigenza, anche customized, con consegne rapide in ogni parte del mondo.



Luxor S.p.A. è certificata ISO 9001:2015 dall'istituto di certificazione DEKRA Group

CERTIFICAZIONI



Per informazioni sulle specifiche tecniche e sui prodotti certificati si prega di rivolgersi ai nostri uffici o visitare il sito web degli enti di certificazione corrispondenti.

La lista completa dei prodotti certificati NSF è consultabile al sito www.nsf.org.

La lista completa dei prodotti certificati UPC/cUPC è consultabile al sito www.iapmort.org.

1 VALVOLE RADIATORE

1.1 / EASY

Valvole e Detentori

	Attacco tubo ferro	10		Attacco tubo rame e tubo plastica W24x19	12		Attacco tubo rame e tubo plastica G3/4 eurocono	14
---	--------------------	----	---	--	----	---	---	----

1.2 / THERMOTEKNA

Valvole e Teste Termostatiche

	Kit termostatici: attacco tubo ferro	24		Kit termostatici: attacco tubo rame e tubo plastica W24x19	25		Kit termostatici: attacco tubo rame e tubo plastica G3/4 eurocono	26
	Attacco tubo ferro	27		Attacco tubo rame e tubo plastica W24x19	30		Attacco tubo rame e tubo plastica G3/4 eurocono	33
	Teste Termostatiche	40						

1.3 / SERIE 30

Valvole

	Valvole per radiatore	53
---	-----------------------	----

1.4 / SERIE 50th

Valvole per radiatore

	Kit termostatici: attacco tubo rame e tubo plastica G3/4 eurocono	62		Kit manuali: attacco tubo rame e tubo plastica G3/4 eurocono	65		Valvole termostattizzabili con prerogolazione	67
	Valvole manuali: attacco tubo rame e tubo plastica G3/4 eurocono	70		Valvole monotubo bitubo	72		Testa termostatica con comando e sensore incorporato	73

1.5 / M-MT

Valvole e distributori

	Valvole manuali a 4 vie per impianti monotubo	81		Valvole termostatiche a 4 vie per impianti monotubo	85		Valvole per impianti monotubo e bitubo	88
	Distributori a 4 vie per impianti monotubo e bitubo	94		Valvole coassiali	99		Distributori per impianti monotubo e bitubo per corpi scaldanti	101

1.A / ACCESSORI

	Accessori per valvole, detentori, valvole a 4 vie e distributori	106
---	--	-----

2 COLLETTORI

2.1 / SERIE CP

Collettori semplici



Collettori semplici
componibili

113



Collettori semplici
componibili
con valvole di
intercettazione

120



Ricambi

123



Collettori semplici
componibili con filetti
in fase e valvole di
intercettazione

127



Ricambi

130

2.2 / SERIE CV

Collettori componibili con valvole frontali



Collettori componibili
con valvole frontali

137



Ricambi

139

2.3 / SERIE CC

Collettori complanari



Collettori complanari

143

2.4 / SERIE CD

Collettori di distribuzione



Collettori di
distribuzione
per impianti di
riscaldamento

151

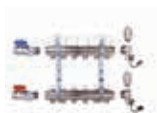

Collettori di
distribuzione premontati
con accessori di
installazione

174

2.5 / SERIE CX

Collettori di distribuzione in acciaio inox



Collettori di
distribuzione in
acciaio inox

190



Collettori di
distribuzione in acciaio
inox premontati
con accessori di
installazione

194



Valvola a sfera
multifunzione

197

2.A / ACCESSORI



Teste termostatiche

202



Accessori per
collettori
di distribuzione

203

3 VALVOLE

	Valvole a sfera	224		Valvole bypass per impianti riscaldamento	229		Valvole di scarico aria	230
	Valvole di sicurezza	233		Valvola miscelatrice	235		Valvole deviatrici di zona	238
	Defangatore magnetico per impianti di riscaldamento	240						

4 GRUPPI PREMONTATI

	Gruppi di rilancio e di miscelazione	242		Sistemi di regolazione per impianti a pannelli radianti con il gruppo pompa GP 1190	245		Sistemi di regolazione con il gruppo pompa GP 1190 e kit per alta temperatura KA 1191	250
	Sistemi di regolazione con il gruppo pompa GP 1190 e kit per alta temperatura FM 750	256		Sistemi di regolazione per impianti a pannelli radianti con il gruppo di miscela GM 1192	261		Gruppi pompa per solare	267

5 ACCESSORI ELETTRICI ED ELETTRONICI

	Teste termoelettriche	277		Termostati di sicurezza a contatto e ad immersione	284		Pompa di circolazione	288
	Servomotori	291		Azionatore per la regolazione temperatura ambiente	294			

6 SISTEMA IDRONICO MODULARE

	Collettori	302		Gruppo di rilancio	304		Gruppo a punto fisso	306
	Gruppo a punto scorrevole	308		Accessori collettori di distribuzione	312		Coibentazione	313

7 RACCORDI

	Raccordi per tubo rame	319		Raccordi per tubo in polietilene, polibutene e polipropilene	320		Raccordi per tubo in polietilene multistrato PEX-AL-PEX	321
	Raccordi a stringere cromati	322		Raccordi sottotraccia per la distribuzione con tubi sfilabili	327		Raccordi per tubi in rame, plastica e multistrato	328



LUXOR®

VALVOLE RADIATORE

1.1 / EASY

EASY

VALVOLE E DETENTORI



La tenuta in chiusura con l'otturatore è assicurata da un o-ring e da una tenuta conica metallica. Le valvole sono prodotte con finitura nichelata. L'apertura delle valvole e detentori deve essere effettuata con pressione differenziale inferiore a un 1 bar.



La tenuta in chiusura con l'otturatore è assicurata da un o-ring e da una tenuta conica metallica. I detentori sono prodotti con finitura nichelata. Tutti i detentori hanno la possibilità di regolare la portata limitando l'alzata dell'otturatore.

CARATTERISTICHE TECNICHE



DN

10
15
20



Max temperatura

120 °C



Max pressione

10 bar



Max pressione differenziale
1 bar



Materiale

CW617N
UNI EN
12165:2016



Manopola

ABS bianco
RAL 9016



Collaudo

100%

ATTACCHI IMPIANTO



Tubo ferro

G 3/8
G 1/2
G 3/4

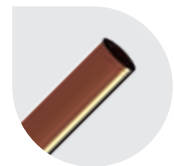

Tubo rame

W 24x19 - TR 91
G 3/4 EK - TR 91/A



Tubo plastica

W 24x19 - TP 95
G 3/4 EK - TP 98



Tubo multistrato

W 24x19 - TP 97
G 3/4 EK - TP 99

COLLEGAMENTO RADIATORE



filetto conico zigrinato

G 3/8
G 1/2
G 3/4



filetto cilindrico con tenuta morbida

G 3/8
G 1/2
G 3/4

VANTAGGI DELL'ASTA REALIZZATA IN DUE PEZZI

La valvola Easy utilizza un'asta fissa la cui tenuta è garantita da due o-rings.

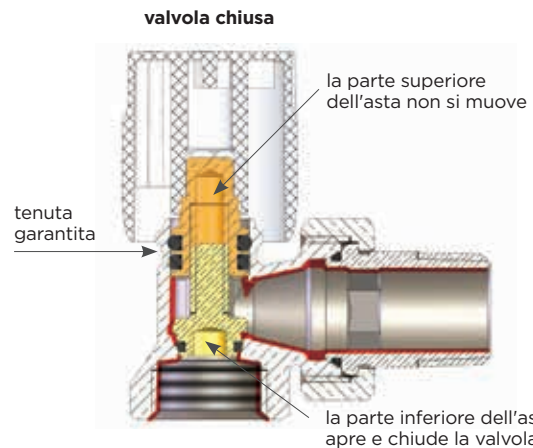
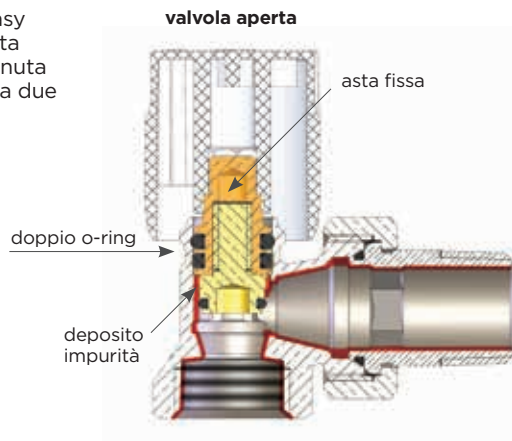

Tutte le valvole e i detentori vengono testati al 100% con prova di tenuta pneumatica a controllo elettronico.

Le caratteristiche del fluido dell'impianto devono essere conformi alla direttiva UNI 8065:2019.

CONFRONTO DEI VANTAGGI DELL'ASTA REALIZZATA IN DUE PEZZI

ASTA IN DUE PEZZI

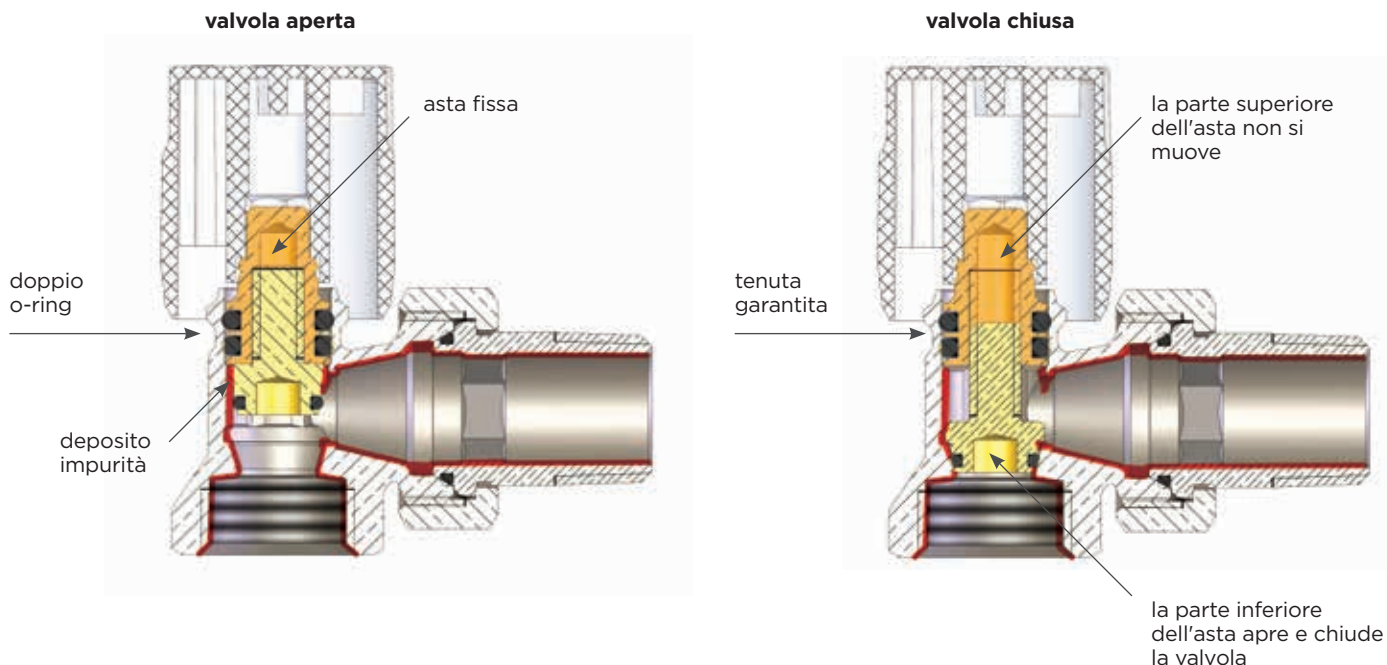

ASTA IN UN PEZZO

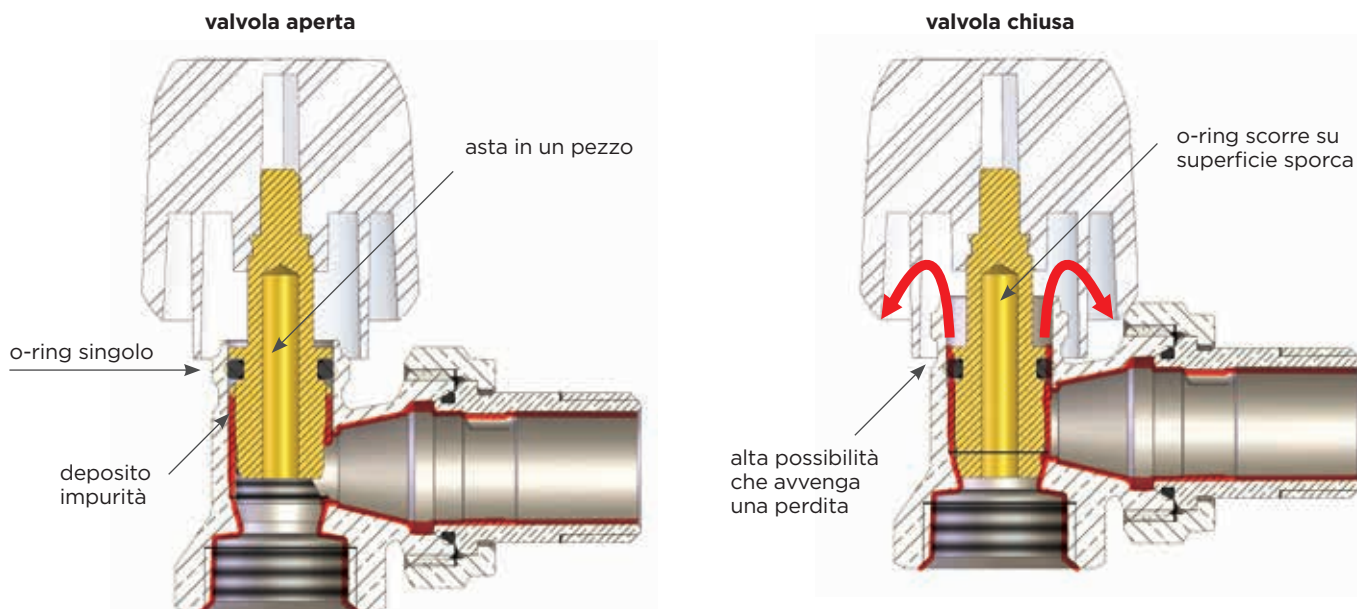

I vantaggi dell'asta realizzata in due pezzi sono molteplici e si verificano sia con la valvola aperta sia con la valvola chiusa.

L'asta fissa, con doppio o-ring, garantisce la tenuta ed evita alle impurità di depositarsi nella sede dove queste guarnizioni lavorano evitando la diminuzione della loro efficacia.

Nell'asta mobile, invece, questo notevole vantaggio non è garantito in quanto la superficie di lavoro delle guarnizioni è esposta alle impurità presenti nel fluido dell'impianto. Questo può aumentare notevolmente la possibilità che avvenga una perdita soprattutto nel medio-lungo periodo.

ATTACCO TUBO FERRO

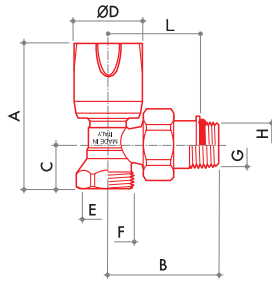

RS 102

Valvola radiatore a squadra a semplice regolazione. Attacco tubo ferro.

Raccordi



CODICE	MISURA	A	B	C	D	E	F	G	H	L			
11021700	DN 10 3/8	65	49	18	32	G 3/8	-	R 3/8	-	-	137	10	80
11022100	DN 15 1/2	67	51	20	32	G 1/2	-	R 1/2	-	-	170	10	80
11022700	DN 20 3/4	70	61	25	32	G 3/4	-	R 3/4	-	-	254	8	64

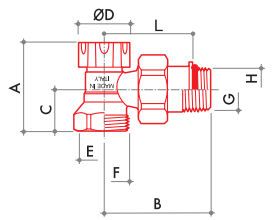

DS 122

Detentore di regolazione a squadra. Attacco tubo ferro.

Raccordi



CODICE	MISURA	A	B	C	D	E	F	G	H	L			
11061700	DN 10 3/8	40	49	18	25	G 3/8	-	R 3/8	-	-	121	10	80
11062100	DN 15 1/2	42	51	20	25	G 1/2	-	R 1/2	-	-	154	10	80
11062700	DN 20 3/4	47	61	25	25	G 3/4	-	R 3/4	-	-	238	8	64

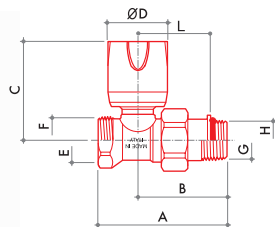

RD 101

Valvola radiatore diritta a semplice regolazione. Attacco tubo ferro.

Raccordi



CODICE	MISURA	A	B	C	D	E	F	G	H	L			
11221700	DN 10 3/8	65	45	53	32	G 3/8	-	R 3/8	-	-	142	10	80
11222100	DN 15 1/2	68	47	53	32	G 1/2	-	R 1/2	-	-	176	10	80
11222700	DN 20 3/4	80	56	55	32	G 3/4	-	R 3/4	-	-	265	8	64

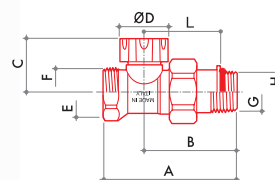

DD 121

Detentore di regolazione diritto. Attacco tubo ferro.

Raccordi

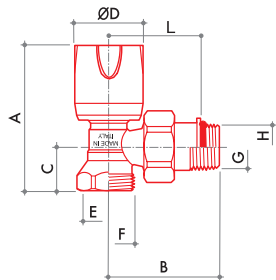

CODICE	MISURA	A	B	C	D	E	F	G	H	L			
11261700	DN 10 3/8	65	45	28	25	G 3/8	-	R 3/8	-	-	132	10	80
11262100	DN 15 1/2	68	47	28	25	G 1/2	-	R 1/2	-	-	161	10	80
11262700	DN 20 3/4	80	56	29	25	G 3/4	-	R 3/4	-	-	248	8	64

**RS 106**

Valvola radiatore a squadra a semplice regolazione. Attacco tubo ferro.

Raccordi

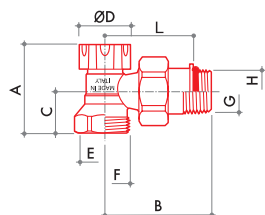

CODICE	MISURA	A	B	C	D	E	F	G	H	L			
11022117	DN 10 3/8	65	46	18	32	G 3/8	-	-	G 3/8	36	143	10	80
11022103	DN 15 1/2	65	47	20	32	G 1/2	-	-	G 1/2	37	174	10	80
11022703	DN 20 3/4	70	58	25	32	G 3/4	-	-	G 3/4	46	257	8	64

**DS 126**

Detentore di regolazione a squadra. Attacco tubo ferro.

Raccordi

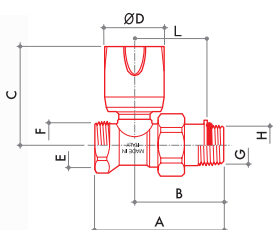

CODICE	MISURA	A	B	C	D	E	F	G	H	L			
11062117	DN 10 3/8	40	46	18	25	G 3/8	-	-	G 3/8	36	127	10	80
11062103	DN 15 1/2	42	47	20	25	G 1/2	-	-	G 1/2	37	158	10	80
11062703	DN 20 3/4	47	59	25	25	G 3/4	-	-	G 3/4	47	241	8	64

**RD 105**

Valvola radiatore diritta a semplice regolazione. Attacco tubo ferro.

Raccordi

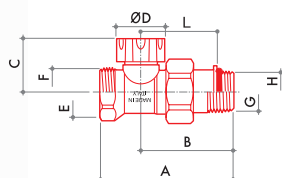

CODICE	MISURA	A	B	C	D	E	F	G	H	L			
11222117	DN 10 3/8	62	42	53	32	G 3/8	-	-	G 3/8	32	148	10	80
11222103	DN 15 1/2	64	43	53	32	G 1/2	-	-	G 1/2	33	180	10	80
11222703	DN 20 3/4	77	53	55	32	G 3/4	-	-	G 3/4	41	268	8	64

**DD 125**

Detentore di regolazione diritto. Attacco tubo ferro.

Raccordi



CODICE	MISURA	A	B	C	D	E	F	G	H	L			
11262117	DN 10 3/8	62	42	28	25	G 3/8	-	-	G 3/8	32	138	10	80
11262103	DN 15 1/2	64	43	28	25	G 1/2	-	-	G 1/2	33	165	10	80
11262703	DN 20 3/4	78	54	29	35	G 3/4	-	-	G 3/4	42	251	8	64



Raccordi per tubo rame



Raccordi per tubo plastica



Raccordi per tubo multistrato



Raccordi: capitolo 7



Accessori: capitolo 1.A

ATTACCO TUBO RAME E TUBO PLASTICA W24x19

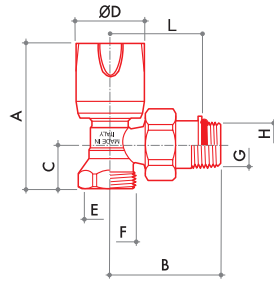

RS 112

Valvola radiatore a squadra a semplice regolazione. Attacco tubo rame e tubo plastica.

Raccordi



CODICE	MISURA	A	B	C	D	E	F	G	H	L			
11121700	DN 10 3/8	67	49	20	32	-	W24x19	R 3/8	-	-	138	10	80
11122100	DN 15 1/2	66	51	20	32	-	W24x19	R 1/2	-	-	159	10	80

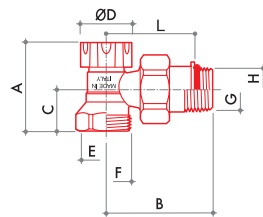

DS 132

Detentore di regolazione a squadra. Attacco tubo rame e tubo plastica.

Raccordi



CODICE	MISURA	A	B	C	D	E	F	G	H	L			
11161700	DN 10 3/8	42	49	20	25	-	W24x19	R 3/8	-	-	122	10	80
11162100	DN 15 1/2	42	51	20	25	-	W24x19	R 1/2	-	-	143	10	80

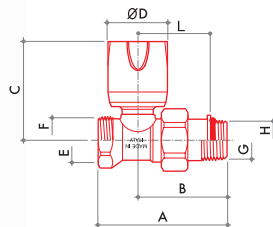

RD 111

Valvola radiatore diritta a semplice regolazione. Attacco tubo rame e tubo plastica.

Raccordi



CODICE	MISURA	A	B	C	D	E	F	G	H	L			
11321700	DN 10 3/8	65	45	53	32	-	W24x19	R 3/8	-	-	144	10	80
11322100	DN 15 1/2	68	47	53	32	-	W24x19	R 1/2	-	-	165	10	80

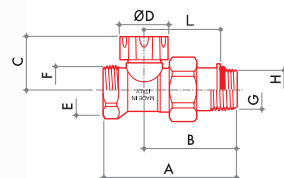

DD 131

Detentore di regolazione diritta. Attacco tubo rame e tubo plastica.

Raccordi

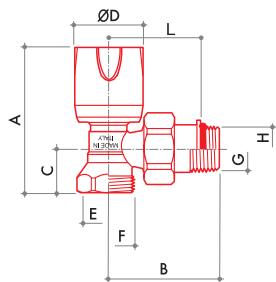

CODICE	MISURA	A	B	C	D	E	F	G	H	L			
11361700	DN 10 3/8	65	45	28	25	-	W24x19	R 3/8	-	-	133	10	80
11362100	DN 15 1/2	68	47	27	25	-	W24x19	R 1/2	-	-	150	10	80

**RS 119**

Valvola radiatore a squadra a semplice regolazione. Attacco tubo rame e tubo plastica.

Raccordi

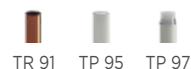

CODICE	MISURA	A	B	C	D	E	F	G	H	L			
11122117	DN 10 3/8	67	46	20	32	-	W24x19	-	G 3/8	36	148	10	80
11122103	DN 15 1/2	66	47	20	32	-	W24x19	-	G 1/2	37	162	10	80

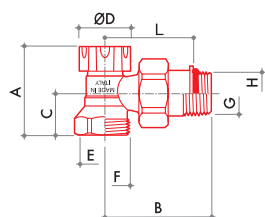
**DS 139**

Detentore di regolazione a squadra. Attacco tubo rame e tubo plastica.

Raccordi

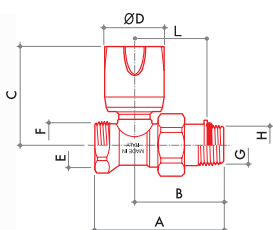

CODICE	MISURA	A	B	C	D	E	F	G	H	L			
11162117	DN 10 3/8	42	46	20	25	-	W24x19	-	G 3/8	36	132	10	80
11162103	DN 15 1/2	42	47	20	25	-	W24x19	-	G 1/2	37	145	10	80

**RD 118**

Valvola radiatore dritta a semplice regolazione. Attacco tubo rame e tubo plastica.

Raccordi

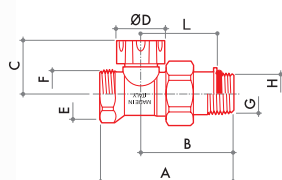

CODICE	MISURA	A	B	C	D	E	F	G	H	L			
11322117	DN 10 3/8	63	42	53	32	-	W24x19	-	G 3/8	32	152	10	80
11322103	DN 15 1/2	64	43	53	32	-	W24x19	-	G 1/2	33	171	10	80

**DD 138**

Detentore di regolazione dritto. Attacco tubo rame e tubo plastica.

Raccordi



CODICE	MISURA	A	B	C	D	E	F	G	H	L			
11362117	DN 10 3/8	63	42	28	25	-	W24x19	-	G 3/8	32	142	10	80
11362103	DN 15 1/2	64	43	27	25	-	W24x19	-	G 1/2	33	161	10	80



Raccordi per tubo rame



Raccordi per tubo plastica



Raccordi per tubo multistrato



Raccordi: capitolo 7



Accessori: capitolo 1.A

ATTACCO TUBO RAME E TUBO PLASTICA G3/4 EUROCONO

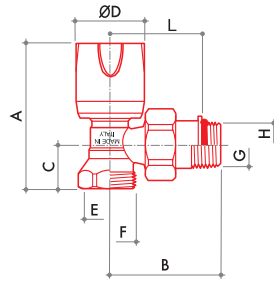

RS 112/A

Valvola radiatore a squadra a semplice regolazione. Attacco tipo eurocono.

Raccordi

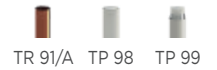

CODICE	MISURA	A	B	C	D	E	F	G	H	L			
11122718	DN 10 3/8	65	49	20	32	-	G 3/4 EK	R 3/8	-	-	148	10	80
11122721	DN 15 1/2	66	51	20	32	-	G 3/4 EK	R 1/2	-	-	161	10	80

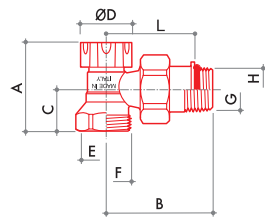

DS 132/A

Detentore di regolazione a squadra. Attacco tipo eurocono.

Raccordi

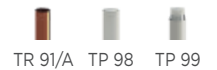

CODICE	MISURA	A	B	C	D	E	F	G	H	L			
11162718	DN 10 3/8	42	49	20	25	-	G 3/4 EK	R 3/8	-	-	130	10	80
11162721	DN 15 1/2	42	51	20	25	-	G 3/4 EK	R 1/2	-	-	144	10	80

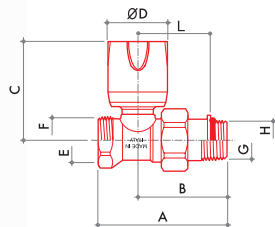

RD 111/A

Valvola radiatore diritta a semplice regolazione. Attacco tipo eurocono.

Raccordi

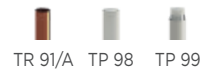

CODICE	MISURA	A	B	C	D	E	F	G	H	L			
11322719	DN 10 3/8	66	45	53	32	-	G 3/4 EK	R 3/8	-	-	149	10	80
11322722	DN 15 1/2	69	48	53	32	-	G 3/4 EK	R 1/2	-	-	170	10	80

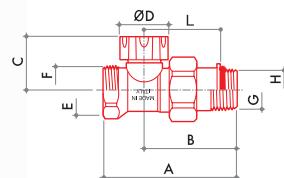

DD 131/A

Detentore di regolazione diritto. Attacco tipo eurocono.

Raccordi

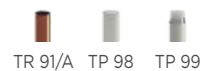

CODICE	MISURA	A	B	C	D	E	F	G	H	L			
11362719	DN 10 3/8	66	45	28	25	-	G 3/4 EK	R 3/8	-	-	138	10	80
11362722	DN 15 1/2	69	48	28	25	-	G 3/4 EK	R 1/2	-	-	160	10	80

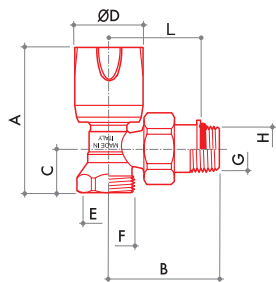
**RS 119/A**

Valvola radiatore a squadra a semplice regolazione. Attacco tipo eurocono.

Raccordi

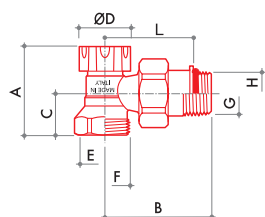

CODICE	MISURA	A	B	C	D	E	F	G	H	L			
11122717	DN 10 3/8	66	46	20	32	-	G 3/4 EK	-	G 3/8	36	151	10	80
11122703	DN 15 1/2	66	47	20	32	-	G 3/4 EK	-	G 1/2	37	165	10	80

**DS 139/A**

Detentore di regolazione a squadra. Attacco tipo eurocono.

Raccordi

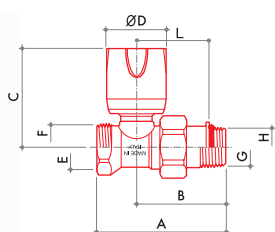

CODICE	MISURA	A	B	C	D	E	F	G	H	L			
11162717	DN 10 3/8	42	46	20	25	-	G 3/4 EK	-	G 3/8	36	135	10	80
11162703	DN 15 1/2	42	47	20	25	-	G 3/4 EK	-	G 1/2	37	148	10	80

**RD 118/A**

Valvola radiatore diritta a semplice regolazione. Attacco tipo eurocono.

Raccordi

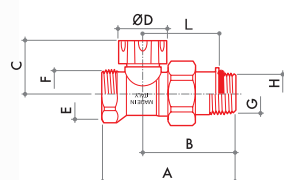

CODICE	MISURA	A	B	C	D	E	F	G	H	L			
11322717	DN 10 3/8	63	42	53	32	-	G 3/4 EK	-	G 3/8	32	155	10	80
11322703	DN 15 1/2	64	43	53	32	-	G 3/4 EK	-	G 1/2	33	174	10	80

**DD 138/A**

Detentore di regolazione diritto. Attacco tipo eurocono.

Raccordi



CODICE	MISURA	A	B	C	D	E	F	G	H	L			
11362717	DN 10 3/8	63	42	28	25	-	G 3/4 EK	-	G 3/8	32	145	10	80
11362703	DN 15 1/2	64	43	27	25	-	G 3/4 EK	-	G 1/2	33	164	10	80



Raccordi per tubo rame



Raccordi per tubo plastica



Raccordi per tubo multistrato



Raccordi: capitolo 7



Accessori: capitolo 1.A

DIAGRAMMA DI PORTATA VALVOLE

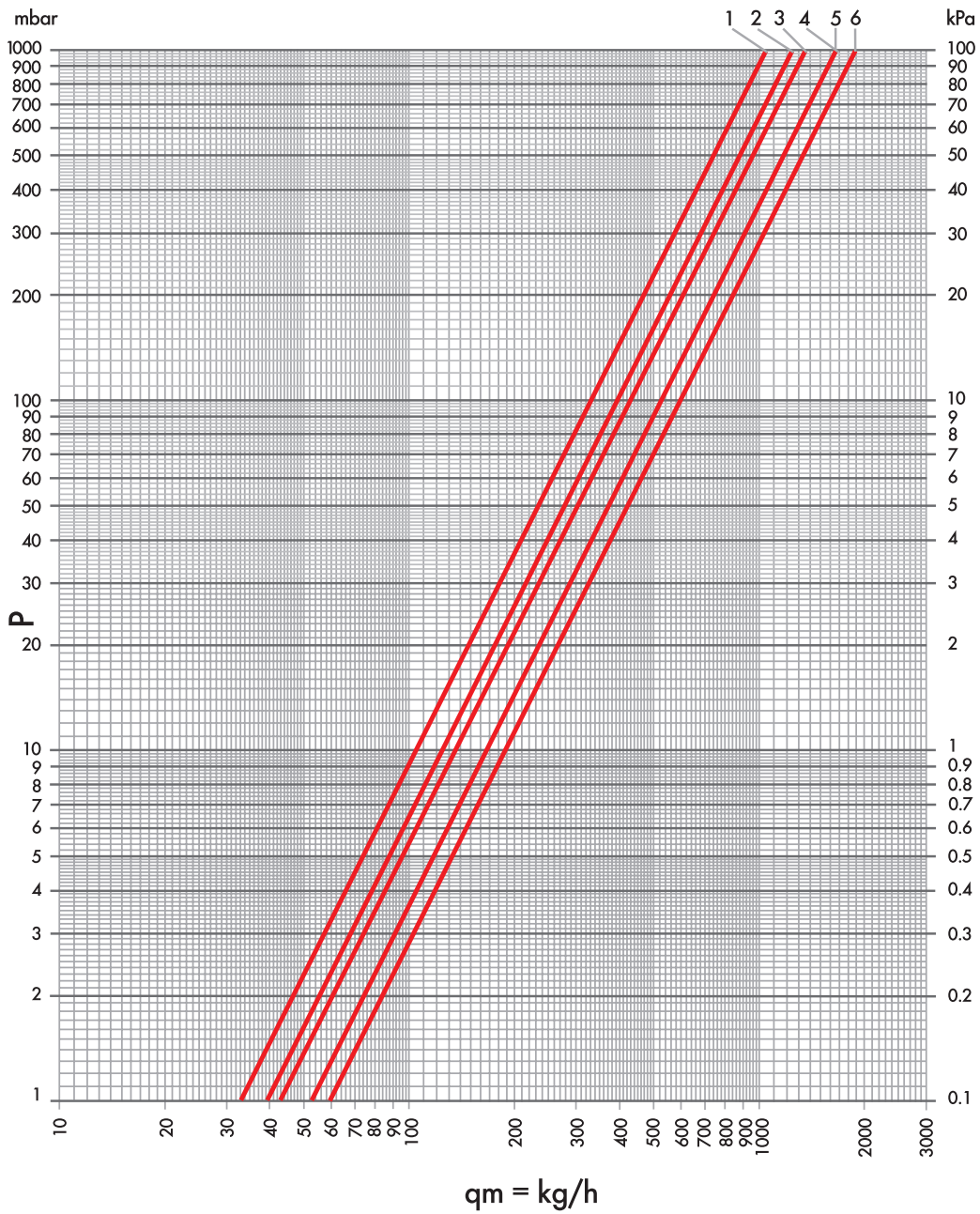

ARTICOLI	Kv	POS
RD 101 3/8 - RD 105 3/8 - RD 111 3/8 RD 118 3/8 - RD 118/A 3/8	1.05	1
RD 101 1/2 - RD 105 1/2 - RD 111 1/2 RD 111/A 1/2 - RD 118 1/2 - RD 118/A 1/2	1.25	2
RD 101 3/4 - RD 105 3/4	1.35	3
RS 102 3/8 - RS 106 3/8 - RS 112 3/8 RS 119 3/8 - RS 119/A 3/8	1.65	4
RS 102 1/2 - RS 106 1/2 - RS 112 1/2 RS 112/A 1/2 - RS 119 1/2 - RS 119/A 1/2	1.65	5
RS 102 3/4 - RS 106 3/4	1.90	6

DIAGRAMMI DI PORTATA DETENTORE

DETENTORE A SQUADRA

DN 10 3/8 - DN 15 1/2

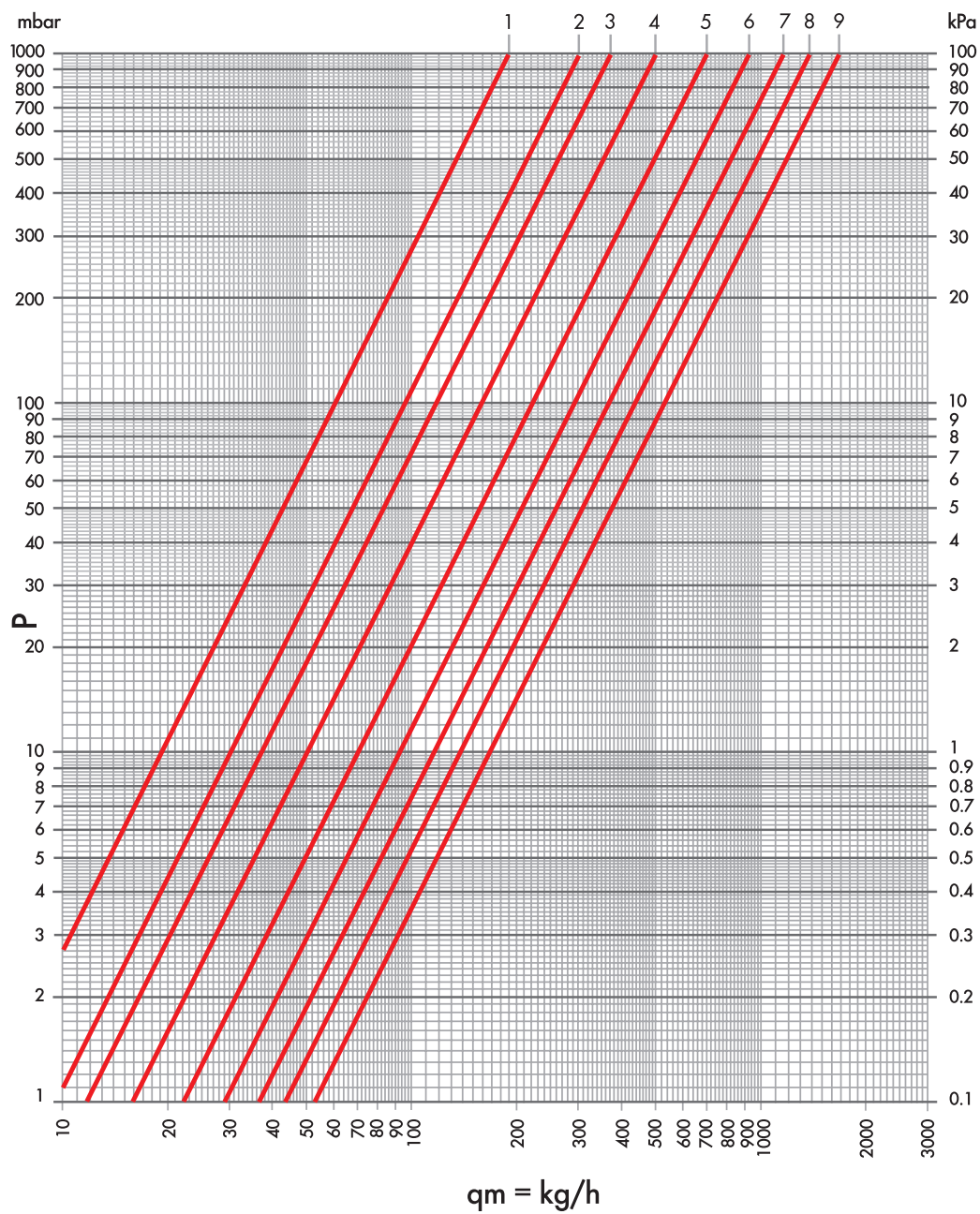

ARTICOLI	N. GIRI	Kvs	POS
DS 122 DS 126 DS 132 DS 139 DS 132/A DS 139/A	1	0.19	1
	1+1/2	0.30	2
	2	0.37	3
	2+1/2	0.50	4
	3	0.69	5
	3+1/2	0.92	6
	4	1.14	7
	4+1/2	1.39	8
	tutto aperto	1.65	9

DIAGRAMMI DI PORTATA DETENTORE

DETENTORE A SQUADRA

DN 20 3/4

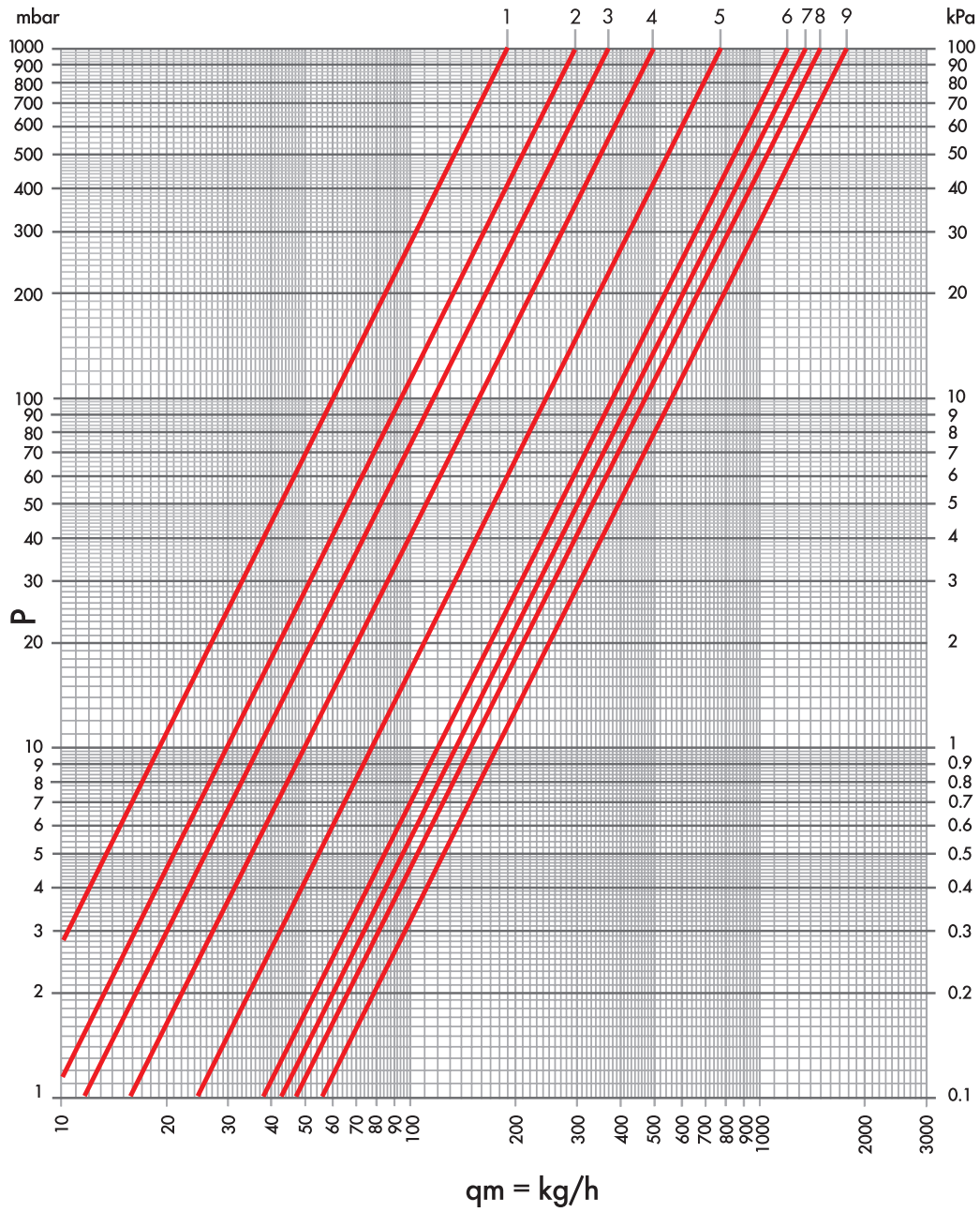

ARTICOLI	N. GIRI	Kvs	POS
DS 122 DS 126 DS 132 DS 139 DS 132/A DS 139/A	1	0.19	1
	1+1/2	0.30	2
	2	0.37	3
	2+1/2	0.50	4
	3	0.78	5
	3+1/2	1.19	6
	4	1.34	7
	4+1/2	1.50	8
	tutto aperto	1.75	9

DIAGRAMMI DI PORTATA DETENTORE

DETENTORE DIRITTO

DN 10 3/8 - DN 15 1/2

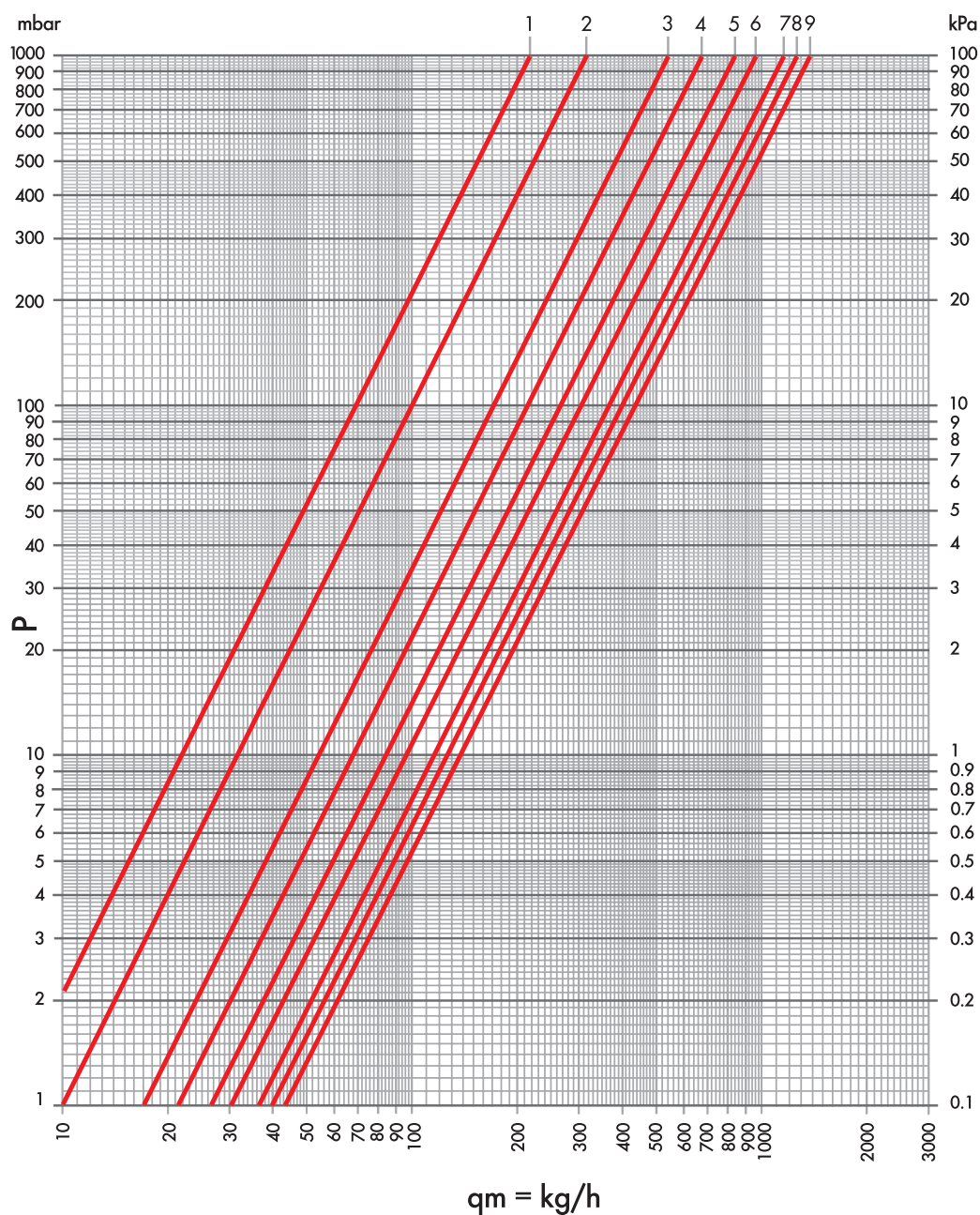

ARTICOLI	N. GIRI	Kvs	POS
DD 121 DD 125 DD 131 DD 138 DD 131/A DD 138/A	1	0.22	1
	1+1/2	0.32	2
	2	0.53	3
	2+1/2	0.68	4
	3	0.84	5
	3+1/2	0.97	6
	4	1.14	7
	4+1/2	1.25	8
	tutto aperto	1.34	9

DIAGRAMMI DI PORTATA DETENTORE

DETENTORE DIRITTO

DN 20 3/4

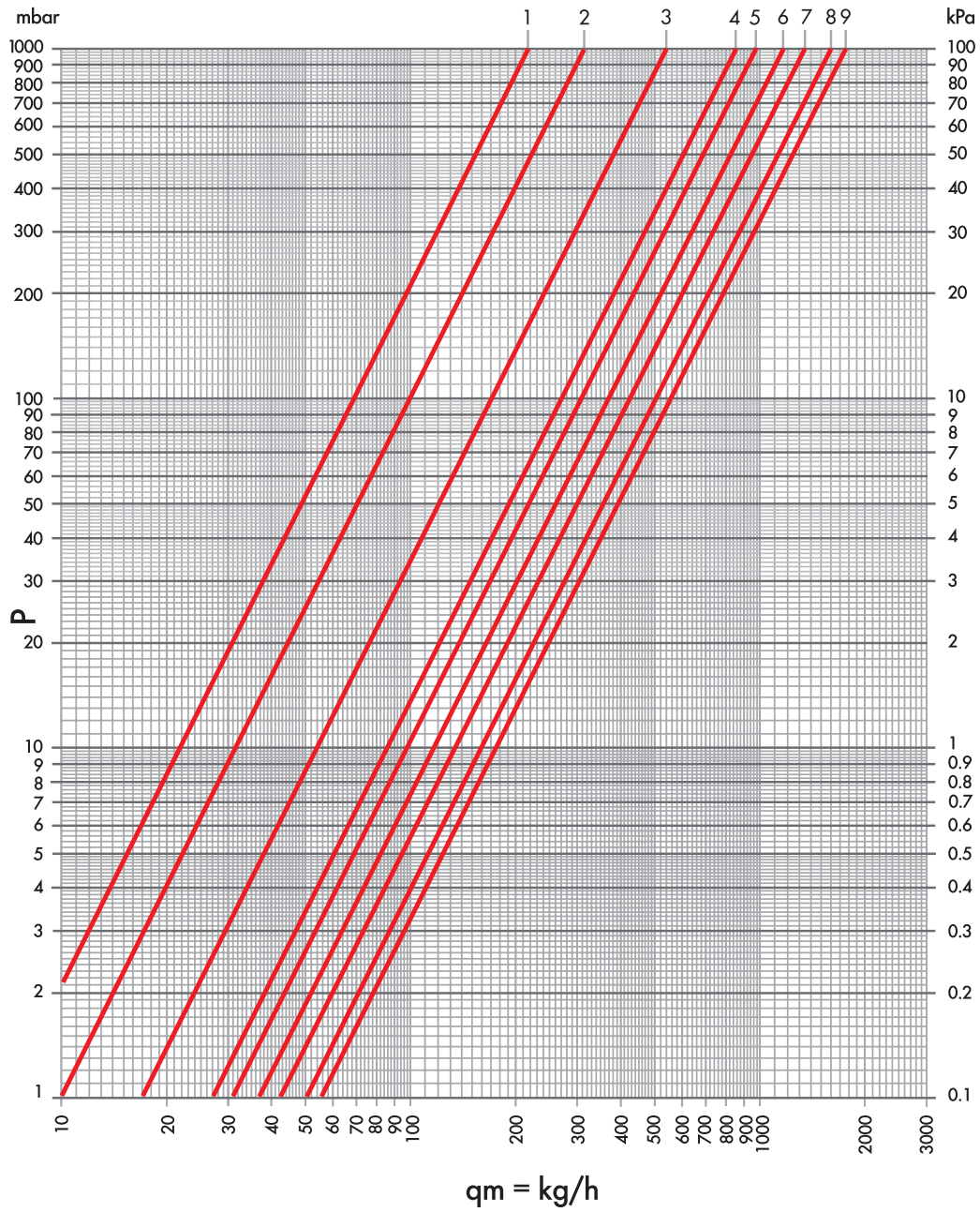

ARTICOLI	N. GIRI	Kvs	POS
DD 121 DD 125 DD 131 DD 138 DD 131/A DD 138/A	1	0.22	1
	1+1/2	0.32	2
	2	0.54	3
	2+1/2	0.85	4
	3	0.97	5
	3+1/2	1.19	6
	4	1.34	7
	4+1/2	1.60	8
	tutto aperto	1.75	9



LUXOR®

VALVOLE RADIATORE

1.2 / THERMOTEKNA

THERMOTEKNA

CORPI VALVOLA TERMOSTATIZZABILI CON PREREGOLAZIONE

**REVERSE
FLOW**



* UNI EN 215
Approved

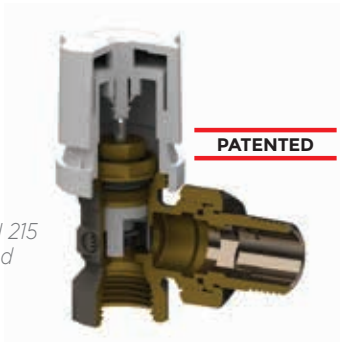

Le valvole ThermoTekna hanno un vitone che offre la possibilità di prerogolazione grazie ad un anello in acetilica sagomato. Il vitone termostatico permette la sostituzione di uno degli o-ring di tenuta sull'asta di comando senza che sia necessario svuotare l'impianto. Le valvole, dove segnalato, sono certificate UNI EN215. Le valvole sono prodotte con finitura nichelata. L'apertura delle valvole e detentori deve essere effettuata con pressione differenziale inferiore a un 1 bar.

I detentori Tekna hanno la tenuta assicurata da un o-ring sull'otturatore e se necessario da un ulteriore o-ring tra il corpo e il tappo. La tenuta in chiusura con l'otturatore è assicurata da un o-ring e da una tenuta conica metallica. I detentori sono prodotti con finitura nichelata. Tutti i detentori hanno la possibilità di regolare la portata limitando l'alzata dell'otturatore.

CARATTERISTICHE TECNICHE



DN

10
15
20



Max temperatura

120 °C



Max pressione

10 bar



Max pressione differenziale
(valvole termostatiche)

0,6 bar



Max pressione differenziale

1 bar



Materiale

CW617N
UNI EN
12165:2016



Manopola

ABS bianco
RAL 9016



Asta di comando

AISI 316



Collaudo

100%

ATTACCHI IMPIANTO



Tubo ferro

G 3/8
G 1/2
G 3/4

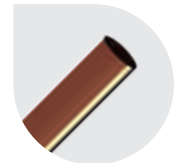

Tubo rame

W 24x19 - TR 91
G 3/4 EK - TR 91/A



Tubo plastica

W 24x19 - TP 95
G 3/4 EK - TP 98



Tubo multistrato

W 24x19 - TP 97
G 3/4 EK - TP 99

COLLEGAMENTO RADIATORE



**filetto
conico zigrinato**

G 3/8
G 1/2
G 3/4



**filetto
cilindrico con
tenuta morbida**

G 3/8
G 1/2
G 3/4

Tutte le valvole e i detentori vengono testati al 100% con prova di tenuta pneumatica a controllo elettronico.

Le caratteristiche del fluido dell'impianto devono essere conformi alla direttiva UNI 8065:2019.

REGOLAZIONE DELLA PORTATA E REVERSE FLOW

Per regolare la massima portata della valvola si deve agire nel seguente modo:

- allineare la tacca di riferimento presente sull'asta in acciaio inox con una delle posizioni stampate sul corpo della valvola.

Le valvole termostatiche Luxor hanno ottenuto la certificazione EN215 anche in condizione di flusso inverso.

Grazie a questa caratteristica possono essere installate sia sulla mandata sia sul ritorno del radiatore fino ad una pressione differenziale di 0,6 bar.

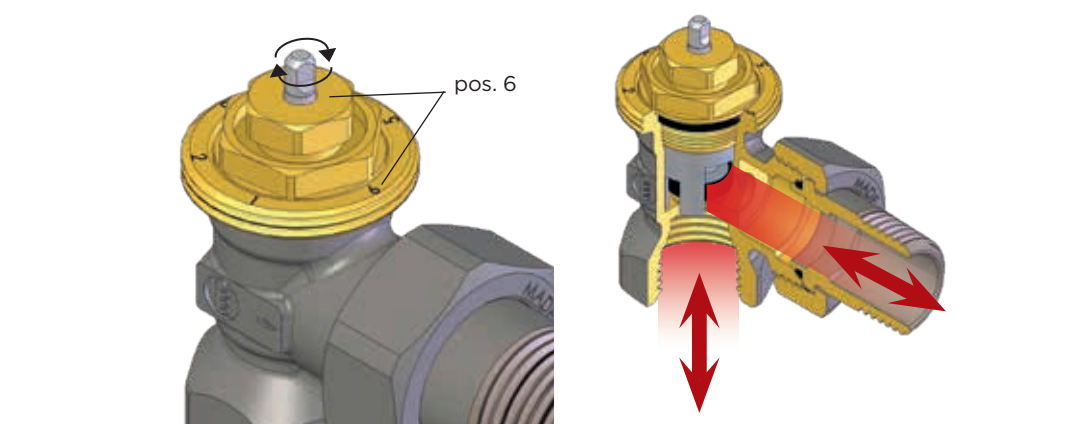
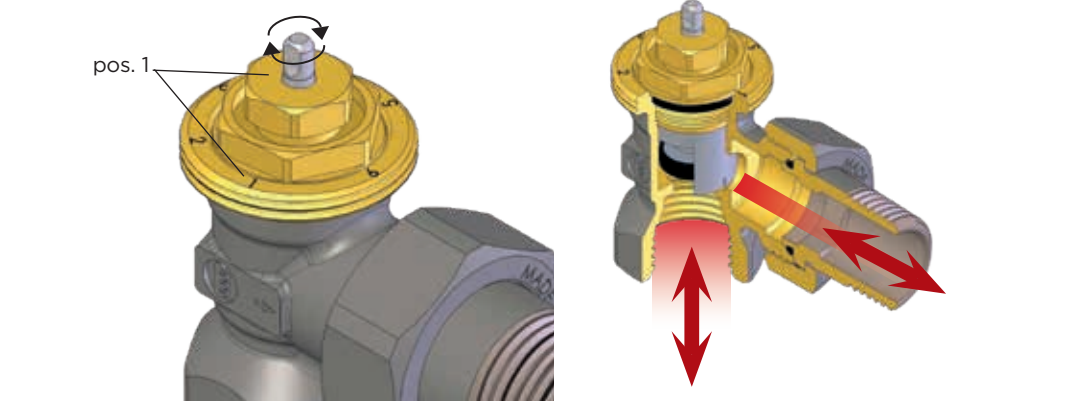

TENUTA SULLO STELO

Il sistema di tenuta può essere facilmente sostituito senza svuotare l'impianto:

- svitare la ghiera con testa esagonale con una chiave a stella da 13 mm;
- togliere l'o-ring "art. 582 - cod. 3424602", pulire l'asta in inox e inserire un nuovo o-ring "art. 582";
- montare la ghiera avvitando a fondo.



KIT TERMOSTATICI: ATTACCO TUBO FERRO



* UNI EN 215
Approved

KT 202

Kit termostatico completo per collegamento al radiatore. Composto da RS 202 + DS 22 + TT 3000. Attacco tubo ferro.

CODICE	MISURA					
12821700	DN 10 3/8	-	-	-	436	1 32
12822100*	DN 15 1/2	TR 92	-	TP 90	521	1 32
12822700	DN 20 3/4	-	-	-	671	1 32



KT 201

Kit termostatico completo per collegamento al radiatore. Composto da RD 201 + DD 21 + TT 3000. Attacco tubo ferro.

CODICE	MISURA					
12901700	DN 10 3/8	-	-	-	473	1 32
12902100	DN 15 1/2	TR 92	-	TP 90	514	1 32
12902700	DN 20 3/4	-	-	-	685	1 32



* UNI EN 215
Approved

KT 206

Kit termostatico completo per collegamento al radiatore. Composto da RS 206 + DS 26 + TT 3000. Attacco tubo ferro.

CODICE	MISURA					
12822117	DN 10 3/8	-	-	-	426	1 32
12822103*	DN 15 1/2	TR 92	-	TP 90	501	1 32
12822703	DN 20 3/4	-	-	-	636	1 32



KT 205

Kit termostatico completo per collegamento al radiatore. Composto da RD 205 + DD 25 + TT 3000. Attacco tubo ferro.

CODICE	MISURA					
12942117	DN 10 3/8	-	-	-	471	1 32
12942103	DN 15 1/2	TR 92	-	TP 90	536	1 32
12942703	DN 20 3/4	-	-	-	706	1 32

KIT TERMOSTATICI: ATTACCO TUBO RAME E TUBO PLASTICA W24x19



* UNI EN 215
Approved

KT 212

Kit termostatico completo per collegamento al radiatore. Composto da RS 212 + DS 32 + TT 3000. Attacco tubo rame e tubo plastica.

CODICE	MISURA						
12841700*	DN 10 3/8	TR 91	TP 95	TP 97	424	1	32
12842100*	DN 15 1/2	TR 91	TP 95	TP 97	477	1	32

**KT 211**

Kit termostatico completo per collegamento al radiatore. Composto da RD 211 + DD 31 + TT 3000. Attacco tubo rame e tubo plastica.

CODICE	MISURA						
12861700	DN 10 3/8	TR 91	TP 95	TP 97	445	1	32
12862100	DN 15 1/2	TR 91	TP 95	TP 97	492	1	32



* UNI EN 215
Approved

KT 209

Kit termostatico completo per collegamento al radiatore. Composto da RS 209 + DS 39 + TT 3000. Attacco tubo rame e tubo plastica.

CODICE	MISURA						
12842117*	DN 10 3/8	TR 91	TP 95	TP 97	441	1	32
12842103*	DN 15 1/2	TR 91	TP 95	TP 97	484	1	32

**KT 208**

Kit termostatico completo per collegamento al radiatore. Composto da RD 208 + DD 38 + TT 3000. Attacco tubo rame e tubo plastica.

CODICE	MISURA						
12962117	DN 10 3/8	TR 91	TP 95	TP 97	348	1	32
12962103	DN 15 1/2	TR 91	TP 95	TP 97	381	1	32



Raccordi per tubo rame



Raccordi per tubo plastica



Raccordi per tubo multistrato



Raccordi: capitolo 7



Accessori: capitolo 1.A

KIT TERMOSTATICI: ATTACCO TUBO RAME E TUBO PLASTICA G3/4 EUROCONO



* UNI EN 215
Approved

KT 212/A

Kit termostatico completo per collegamento al radiatore. Composto da RS 212/A + DS 32/A + TT 3000. Attacco tipo eurocono.

CODICE	MISURA						
12842718*	DN 10 3/8	TR 91/A	TP 98	TP 99	406	1	32
12842721*	DN 15 1/2	TR 91/A	TP 98	TP 99	483	1	32



KT 211/A

Kit termostatico completo per collegamento al radiatore. Composto da RD 211/A + DD 31/A + TT 3000. Attacco tipo eurocono.

CODICE	MISURA						
12862719	DN 10 3/8	TR 91/A	TP 98	TP 99	440	1	32
12862722	DN 15 1/2	TR 91/A	TP 98	TP 99	484	1	32



* UNI EN 215
Approved

KT 209/A

Kit termostatico completo per collegamento al radiatore. Composto da RS 209/A + DS 39/A + TT 3000. Attacco tipo eurocono.

CODICE	MISURA						
12842717*	DN 10 3/8	TR 91/A	TP 98	TP 99	447	1	32
12842703*	DN 15 1/2	TR 91/A	TP 98	TP 99	484	1	32



KT 208/A

Kit termostatico completo per collegamento al radiatore. Composto da RD 208/A + DD 38/A + TT 3000. Attacco tipo eurocono.

CODICE	MISURA						
12962717	DN 10 3/8	TR 91/A	TP 98	TP 99	340	1	32
12962703	DN 15 1/2	TR 91/A	TP 98	TP 99	380	1	32

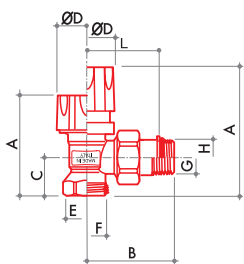

ATTACCO TUBO FERRO

**RS 202**

Valvola radiatore a squadra termostattabile o elettrocomandabile con cappuccio di protezione. Attacco tubo ferro.



Raccordi



** Solo per le misure indicate

CODICE	MISURA	A	B	C	D	E	F	G	H	L			
12021700	DN 10 3/8	58	50	20	37	G 3/8	-	R 3/8	-	-	156	10	80
12022100*	DN 15 1/2**	60	53	23	37	G 1/2	-	R 1/2	-	-	198	10	80
12022700	DN 20 3/4	60	62	27	37	G 3/4	-	R 3/4	-	-	264	8	64

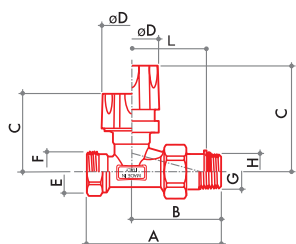
**RD 201**

Valvola radiatore diritta termostattabile o elettrocomandabile con cappuccio di protezione. Attacco tubo ferro.

Raccordi



** Solo per le misure indicate

CODICE	MISURA	A	B	C	D	E	F	G	H	L			
12221700	DN 10 3/8	76	51	46	37	G 3/8	-	R 3/8	-	-	177	10	80
12222100	DN 15 1/2**	83	55	46	37	G 1/2	-	R 1/2	-	-	216	10	80
12222700	DN 20 3/4	97	65	47	37	G 3/4	-	R 3/4	-	-	301	8	64

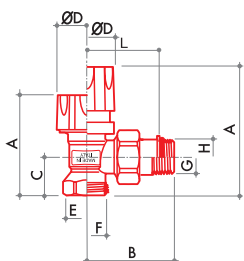
**RS 206**

Valvola radiatore a squadra termostattabile o elettrocomandabile con cappuccio di protezione. Attacco tubo ferro.



Raccordi



** Solo per le misure indicate

CODICE	MISURA	A	B	C	D	E	F	G	H	L			
12022117	DN 10 3/8	58	47	20	37	G 3/8	-	-	G 3/8	37	164	10	80
12022103*	DN 15 1/2**	61	49	23	37	G 1/2	-	-	G 1/2	39	202	10	80
12022703	DN 20 3/4	60	60	27	37	G 3/4	-	-	G 3/4	48	267	8	64

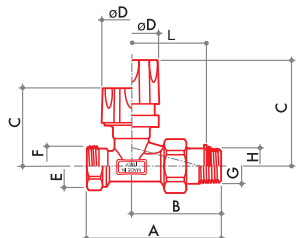
**RD 205**

Valvola radiatore diritta termostattabile o elettrocomandabile con cappuccio di protezione. Attacco tubo ferro.

Raccordi



** Solo per le misure indicate

CODICE	MISURA	A	B	C	D	E	F	G	H	L			
12222117	DN 10 3/8	73	48	46	37	G 3/8	-	-	G 3/8	38	185	10	80
12222103	DN 15 1/2**	78	51	46	37	G 1/2	-	-	G 1/2	40	220	10	80
12222703	DN 20 3/4	95	63	47	37	G 3/4	-	-	G 3/4	51	305	8	64



Raccordi per tubo rame



Raccordi per tubo plastica



Raccordi per tubo multistrato



Raccordi: capitolo 7



Accessori: capitolo 1.A

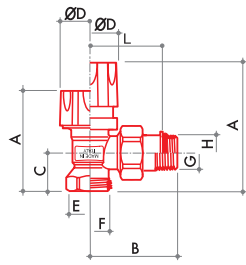

RS 2502

Valvola radiatore a squadra termostattizzabile o elettrocomandabile con volantino di comando manuale. Attacco tubo ferro.



Raccordi



CODICE	MISURA	A	B	C	D	E	F	G	H	L			
12621700	DN 10 3/8	75	50	20	37	G 3/8	-	R 3/8	-	-	165	10	80
12622100*	DN 15 1/2**	78	53	23	37	G 1/2	-	R 1/2	-	-	201	10	80
12622700	DN 20 3/4	78	62	27	37	G 3/4	-	R 3/4	-	-	277	8	64

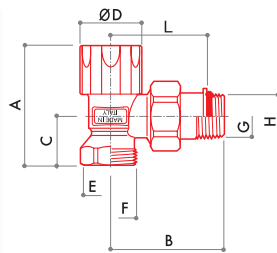

DS 22

Detentore di regolazione a squadra. Attacco tubo ferro.

Raccordi



CODICE	MISURA	A	B	C	D	E	F	G	H	L			
10061700	DN 10 3/8	53	50	20	30	G 3/8	-	R 3/8	-	-	132	10	80
10062100	DN 15 1/2**	57	54	23	30	G 1/2	-	R 1/2	-	-	170	10	80
10062700	DN 20 3/4	57	62	27	30	G 3/4	-	R 3/4	-	-	244	8	64

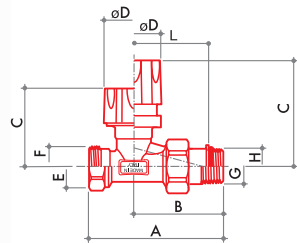

RD 2501

Valvola radiatore diritta termostattizzabile o elettrocomandabile con volantino di comando manuale. Attacco tubo ferro.

Raccordi



CODICE	MISURA	A	B	C	D	E	F	G	H	L			
12421700	DN 10 3/8	76	51	64	37	G 3/8	-	R 3/8	-	-	184	10	80
12422100	DN 15 1/2**	83	55	64	37	G 1/2	-	R 1/2	-	-	220	10	80
12422700	DN 20 3/4	97	65	65	37	G 3/4	-	R 3/4	-	-	309	8	64

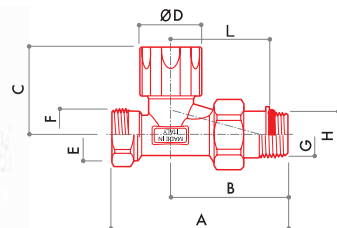

DD 21

Detentore di regolazione diritto. Attacco tubo ferro.

Raccordi

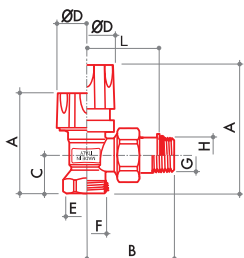

CODICE	MISURA	A	B	C	D	E	F	G	H	L			
10261700	DN 10 3/8	76	51	41	30	G 3/8	-	R 3/8	-	-	153	10	80
10262100	DN 15 1/2**	83	55	42	30	G 1/2	-	R 1/2	-	-	187	10	80
10262700	DN 20 3/4	97	65	43	30	G 3/4	-	R 3/4	-	-	273	8	64

**RS 2506**

Valvola radiatore a squadra termostattizzabile o elettrocomandabile con volantino di comando manuale. Attacco tubo ferro.



* UNI EN 215
Approved

Raccordi



** Solo per le misure indicate

CODICE	MISURA	A	B	C	D	E	F	G	H	L			
12622117	DN 10 3/8	75	47	20	37	G 3/8	-	-	G 3/8	37	192	10	80
12622103*	DN 15 1/2**	78	49	23	37	G 1/2	-	-	G 1/2	39	224	10	80
12622703	DN 20 3/4	78	60	27	37	G 3/4	-	-	G 3/4	48	275	8	64

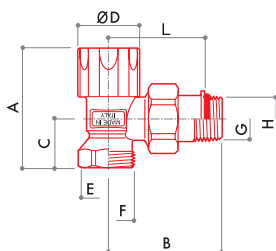
**DS 26**

Detentore di regolazione a squadra. Attacco tubo ferro.

Raccordi



** Solo per le misure indicate

CODICE	MISURA	A	B	C	D	E	F	G	H	L			
10062117	DN 10 3/8	53	47	20	30	G 3/8	-	-	G 3/8	37	138	10	80
10062103	DN 15 1/2**	57	50	23	30	G 1/2	-	-	G 1/2	39	174	10	80
10062703	DN 20 3/4	57	57	27	30	G 3/4	-	-	G 3/4	45	247	8	64

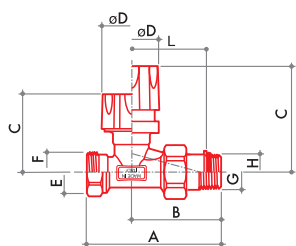
**RD 2505**

Valvola radiatore diritta termostattizzabile o elettrocomandabile con volantino di comando manuale. Attacco tubo ferro.

Raccordi

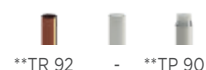

** Solo per le misure indicate

CODICE	MISURA	A	B	C	D	E	F	G	H	L			
12422117	DN 10 3/8	73	48	64	37	G 3/8	-	-	G 3/8	38	173	10	80
12422103	DN 15 1/2**	78	51	64	37	G 1/2	-	-	G 1/2	40	205	10	80
12422703	DN 20 3/4	95	63	65	37	G 3/4	-	-	G 3/4	51	290	8	64

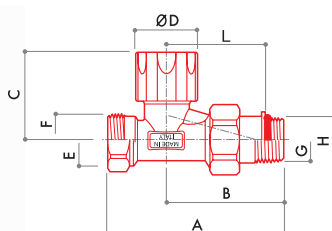
**DD 25**

Detentore di regolazione diritto. Attacco tubo ferro.

Raccordi



** Solo per le misure indicate

CODICE	MISURA	A	B	C	D	E	F	G	H	L			
10262117	DN 10 3/8	73	48	41	30	G 3/8	-	-	G 3/8	38	159	10	80
10262103	DN 15 1/2**	78	51	42	30	G 1/2	-	-	G 1/2	40	191	10	80
10262703	DN 20 3/4	95	63	43	30	G 3/4	-	-	G 3/4	51	276	8	64

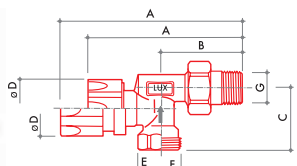
**M 332**

Valvola radiatore a corpo reverso termostattizzabile o elettrocomandabile con volantino di comando manuale. Attacchi tubo ferro.

Raccordi



** Solo per le misure indicate

CODICE	MISURA	A	B	C	D	E	F	G	H	L			
13222100	DN 15 1/2	116	52	40	35	G 1/2	-	R 1/2	-	-	228	10	80



Raccordi per tubo rame



Raccordi per tubo plastica



Raccordi per tubo multistrato



Raccordi: capitolo 7



Accessori: capitolo 1.A

ATTACCO TUBO RAME E TUBO PLASTICA W24x19

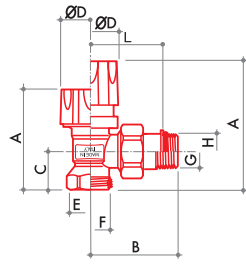

RS 212

Valvola radiatore a squadra termostattabile o elettrocomandabile con cappuccio di protezione. Attacco tubo rame e tubo plastica.



Raccordi



CODICE	MISURA	A	B	C	D	E	F	G	H	L			
12121700*	DN 10 3/8	57	52	19	37	-	W24x19	R 3/8	-	-	158	10	80
12122100*	DN 15 1/2	59	54	22	37	-	W24x19	R 1/2	-	-	182	10	80

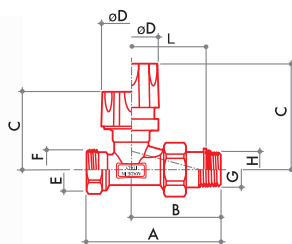

RD 211

Valvola radiatore diritta termostattabile o elettrocomandabile con cappuccio di protezione. Attacco tubo rame e tubo plastica.

Raccordi



CODICE	MISURA	A	B	C	D	E	F	G	H	L			
12321700	DN 10 3/8	76	51	46	37	-	W24x19	R 3/8	-	-	179	10	80
12322100	DN 15 1/2	81	55	46	37	-	W24x19	R 1/2	-	-	203	10	80

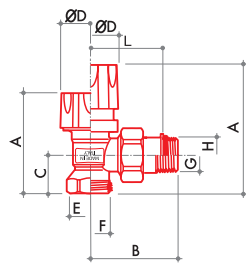

RS 209

Valvola radiatore a squadra termostattabile o elettrocomandabile con cappuccio di protezione. Attacco tubo rame e tubo plastica.



Raccordi



CODICE	MISURA	A	B	C	D	E	F	G	H	L			
12122117*	DN 10 3/8	57	47	19	37	-	W24x19	-	G 3/8	37	164	10	80
12122103*	DN 15 1/2	60	49	22	37	-	W24x19	-	G 1/2	39	185	10	80

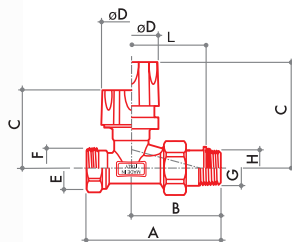

RD 208

Valvola radiatore diritta termostattabile o elettrocomandabile con cappuccio di protezione. Attacco tubo rame e tubo plastica.

Raccordi

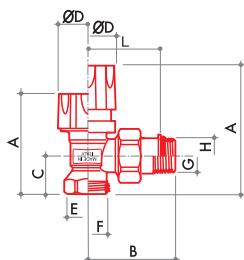

CODICE	MISURA	A	B	C	D	E	F	G	H	L			
12322117	DN 10 3/8	73	48	46	37	-	W24x19	-	G 3/8	38	186	10	80
12322103	DN 15 1/2	78	51	46	37	-	W24x19	-	G 1/2	40	203	10	80

**RS 2512**

Valvola radiatore a squadra termostattizzabile o elettrocomandabile con volantino di comando manuale. Attacco tubo rame e tubo plastica.



Raccordi

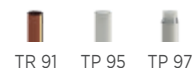

CODICE	MISURA	A	B	C	D	E	F	G	H	L			
12721700*	DN 10 3/8	74	52	19	37	-	W24x19	R 3/8	-	-	166	10	80
12722100*	DN 15 1/2	77	54	22	37	-	W24x19	R 1/2	-	-	192	10	80

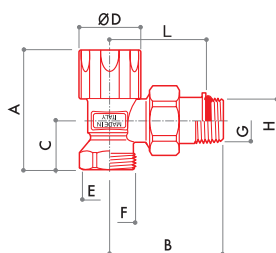
**DS 32**

Detentore di regolazione a squadra. Attacco tubo rame e tubo plastica.

Raccordi

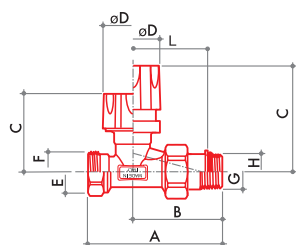

CODICE	MISURA	A	B	C	D	E	F	G	H	L			
10161700	DN 10 3/8	52	50	19	30	-	W24x19	R 3/8	-	-	130	10	80
10162100	DN 15 1/2	56	54	22	30	-	W24x19	R 1/2	-	-	159	10	80

**RD 2511**

Valvola radiatore diretta termostattizzabile o elettrocomandabile con volantino di comando manuale. Attacco tubo rame e tubo plastica.

Raccordi

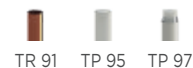

CODICE	MISURA	A	B	C	D	E	F	G	H	L			
12521700	DN 10 3/8	76	51	64	37	-	W24x19	R 3/8	-	-	185	10	80
12522100	DN 15 1/2	81	55	64	37	-	W24x19	R 1/2	-	-	207	10	80

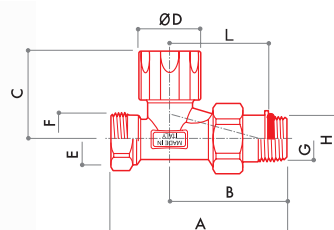
**DD 31**

Detentore di regolazione diretto. Attacco tubo rame e tubo plastica.

Raccordi

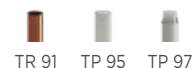

CODICE	MISURA	A	B	C	D	E	F	G	H	L			
10361700	DN 10 3/8	76	51	41	30	-	W24x19	R 3/8	-	-	155	10	80
10362100	DN 15 1/2	82	55	42	30	-	W24x19	R 1/2	-	-	178	10	80



Raccordi per tubo rame



Raccordi per tubo plastica



Raccordi per tubo multistrato



Raccordi: capitolo 7



Accessori: capitolo 1.A

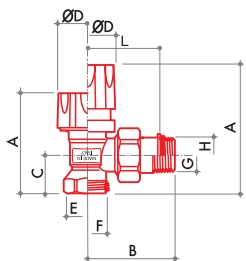

RS 2509

Valvola radiatore a squadra termostattizzabile o elettrocomandabile con volantino di comando manuale. Attacco tubo rame e tubo plastica.



Raccordi



CODICE	MISURA	A	B	C	D	E	F	G	H	L			
12722117*	DN 10 3/8	74	47	19	37	-	W24x19	-	G 3/8	37	172	10	80
12722103*	DN 15 1/2	77	49	22	37	-	W24x19	-	G 1/2	39	193	10	80

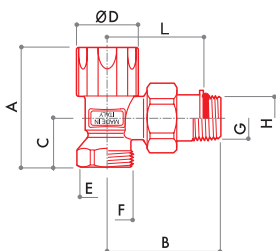

DS 39

Detentore di regolazione a squadra. Attacco tubo rame e tubo plastica.

Raccordi



CODICE	MISURA	A	B	C	D	E	F	G	H	L			
10162117	DN 10 3/8	52	47	19	30	-	W24x19	-	G 3/8	37	141	10	80
10162103	DN 15 1/2	56	49	22	30	-	W24x19	-	G 1/2	39	163	10	80

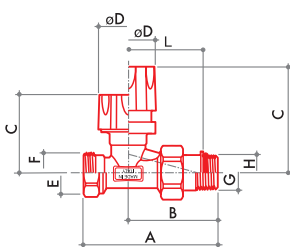

RD 2508

Valvola radiatore diritta termostattizzabile o elettrocomandabile con volantino di comando manuale. Attacco tubo rame e tubo plastica.

Raccordi

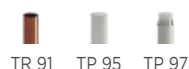

CODICE	MISURA	A	B	C	D	E	F	G	H	L			
12522117	DN 10 3/8	73	48	64	37	-	W24x19	-	G 3/8	38	194	10	80
12522103	DN 15 1/2	77	51	64	37	-	W24x19	-	G 1/2	40	211	10	80

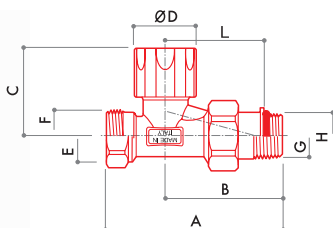

DD 38

Detentore di regolazione diritto. Attacco tubo rame e tubo plastica.

Raccordi



CODICE	MISURA	A	B	C	D	E	F	G	H	L			
10362117	DN 10 3/8	73	48	41	30	-	W24x19	-	G 3/8	38	162	10	80
10362103	DN 15 1/2	77	51	42	30	-	W24x19	-	G 1/2	40	178	10	80

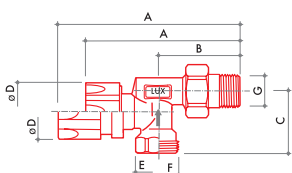

M 330

Valvola radiatore a corpo reverso termostattizzabile o elettrocomandabile con volantino di comando manuale. Attacco tubo rame e tubo plastica.

Raccordi



CODICE	MISURA	A	B	C	D	E	F	G	H	L			
13122100	DN 15 1/2	116	52	39	35	-	W24x19	R 1/2	-	-	215	10	80

ATTACCO TUBO RAME E TUBO PLASTICA G3/4 EUROCONO

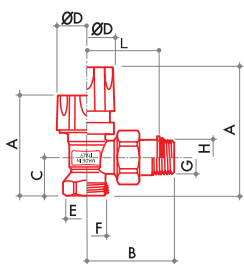
**RS 212/A**

Valvola radiatore a squadra termostattabile o elettrocomandabile con cappuccio di protezione. Attacco tipo eurocono.



Raccordi

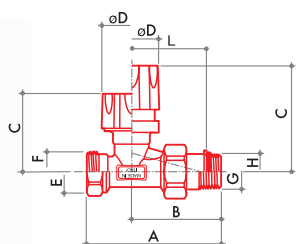

CODICE	MISURA	A	B	C	D	E	F	G	H	L			
12122718*	DN 10 3/8	56	50	19	37	-	G 3/4 EK	R 3/8	-	-	157	10	80
12122721*	DN 15 1/2	59	54	22	37	-	G 3/4 EK	R 1/2	-	-	181	10	80

**RD 211/A**

Valvola radiatore diritta termostattabile o elettrocomandabile con cappuccio di protezione. Attacco tipo eurocono.

Raccordi

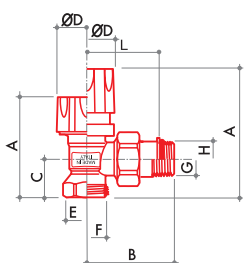

CODICE	MISURA	A	B	C	D	E	F	G	H	L			
12322719	DN 10 3/8	77	52	46	37	-	G 3/4 EK	R 3/8	-	-	170	10	80
12322722	DN 15 1/2	81	55	46	37	-	G 3/4 EK	R 1/2	-	-	199	10	80

**RS 209/A**

Valvola radiatore a squadra termostattabile o elettrocomandabile con cappuccio di protezione. Attacco tipo eurocono.



Raccordi

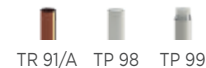

CODICE	MISURA	A	B	C	D	E	F	G	H	L			
12122717*	DN 10 3/8	57	47	19	37	-	G 3/4 EK	-	G 3/8	37	163	10	80
12122703*	DN 15 1/2	60	49	22	37	-	G 3/4 EK	-	G 1/2	39	184	10	80

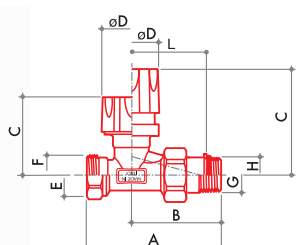
**RD 208/A**

Valvola radiatore diritta termostattabile o elettrocomandabile con cappuccio di protezione. Attacco tipo eurocono.

Raccordi

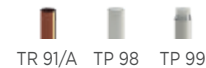

CODICE	MISURA	A	B	C	D	E	F	G	H	L			
12322717	DN 10 3/8	73	48	46	37	-	G 3/4EK	-	G 3/8	38	182	10	80
12322703	DN 15 1/2	77	51	46	37	-	G 3/4EK	-	G 1/2	40	199	10	80



Raccordi per tubo rame



Raccordi per tubo plastica



Raccordi per tubo multistrato



Raccordi: capitolo 7



Accessori: capitolo 1.A

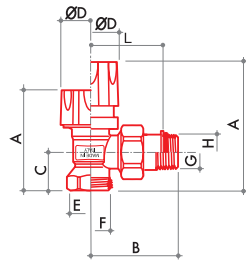

RS 2512/A

Valvola radiatore a squadra termostattizzabile o elettrocomandabile con volantino di comando manuale. Attacco tipo eurocono.



Raccordi



CODICE	MISURA	A	B	C	D	E	F	G	H	L			
12722718*	DN 10 3/8	74	50	19	37	-	G 3/4 EK	R 3/8	-	-	163	10	80
12722721*	DN 15 1/2	77	54	22	37	-	G 3/4 EK	R 1/2	-	-	189	10	80

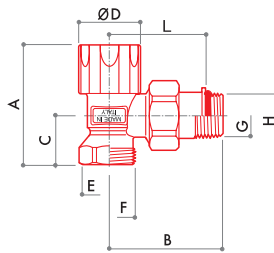

DS 32/A

Detentore di regolazione a squadra. Attacco tipo eurocono.

Raccordi



CODICE	MISURA	A	B	C	D	E	F	G	H	L			
10162718	DN 10 3/8	52	50	19	30	-	G 3/4 EK	R 3/8	-	-	139	10	80
10162721	DN 15 1/2	56	54	22	30	-	G 3/4 EK	R 1/2	-	-	162	10	80

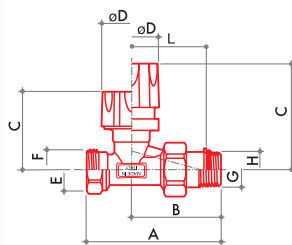

RD 2511/A

Valvola radiatore diritta termostattizzabile o elettrocomandabile con volantino di comando manuale. Attacco tipo eurocono.

Raccordi



CODICE	MISURA	A	B	C	D	E	F	G	H	L			
12522719	DN 10 3/8	77	52	64	37	-	G 3/4 EK	R 3/8	-	-	196	10	80
12522722	DN 15 1/2	81	55	64	37	-	G 3/4 EK	R 1/2	-	-	207	10	80

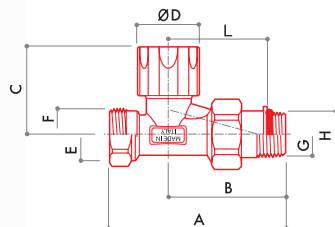

DD 31/A

Detentore di regolazione diritto. Attacco tipo eurocono.

Raccordi



CODICE	MISURA	A	B	C	D	E	F	G	H	L			
10362719	DN 10 3/8	76	51	41	30	-	G 3/4 EK	R 3/8	-	-	164	10	80
10362722	DN 15 1/2	82	55	42	30	-	G 3/4 EK	R 1/2	-	-	174	10	80

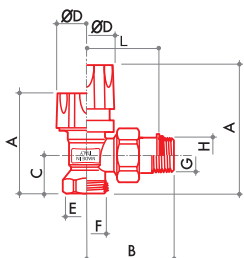

RS 2509/A

Valvola radiatore a squadra termostattabile o elettrocomandabile con volantino di comando manuale. Attacco tipo eurocono.



Raccordi



CODICE	MISURA	A	B	C	D	E	F	G	H	L			
12722717*	DN 10 3/8	74	47	19	37	-	G 3/4EK	-	G 3/8	37	171	10	80
12722703*	DN 15 1/2	77	49	22	37	-	G 3/4EK	-	G 1/2	39	192	10	80

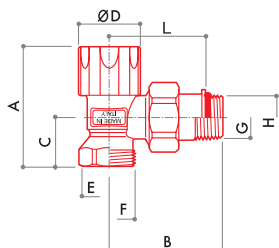

DS 39/A

Detentore di regolazione a squadra. Attacco tipo eurocono.

Raccordi



CODICE	MISURA	A	B	C	D	E	F	G	H	L			
10162717	DN 10 3/8	52	47	19	30	-	G 3/4 EK	-	G 3/8	37	144	10	80
10162703	DN 15 1/2	56	49	22	30	-	G 3/4 EK	-	G 1/2	39	166	10	80

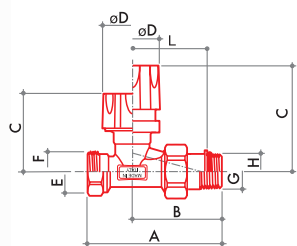

RD 2508/A

Valvola radiatore diritta termostattabile o elettrocomandabile con volantino di comando manuale. Attacco tipo eurocono.

Raccordi



CODICE	MISURA	A	B	C	D	E	F	G	H	L			
12522717	DN 10 3/8	73	48	64	37	-	G 3/4EK	-	G 3/8	38	190	10	80
12522703	DN 15 1/2	77	51	64	37	-	G 3/4EK	-	G 1/2	40	207	10	80

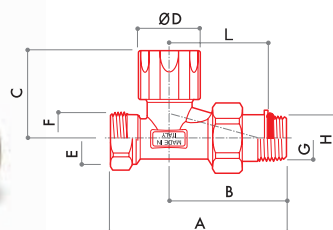

DD 38/A

Detentore di regolazione diritto. Attacco tipo eurocono.

Raccordi



CODICE	MISURA	A	B	C	D	E	F	G	H	L			
10362717	DN 10 3/8	73	48	41	30	-	G 3/4 EK	-	G 3/8	38	165	10	80
10362703	DN 15 1/2	77	51	42	30	-	G 3/4 EK	-	G 1/2	40	178	10	80

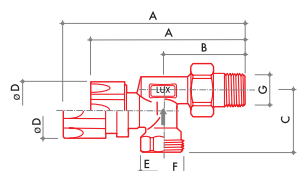

M 330/A

Valvola radiatore a corpo reverso termostattabile o elettrocomandabile con volantino di comando manuale. Attacchi tipo eurocono.

Raccordi



CODICE	MISURA	A	B	C	D	E	F	G	H	L			
13122721	DN 15 1/2	116	52	39	35	-	G 3/4 EK	R 1/2	-	-	217	10	80



Raccordi per tubo rame



Raccordi per tubo plastica



Raccordi per tubo multistrato



Raccordi: capitolo 7



Accessori: capitolo 1.A

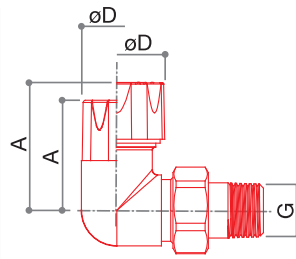

MD 321/A

Valvola radiatore coassiale destra termostattabile o elettrocomandabile con cappuccio di protezione. Attacco tipo eurocono.

Raccordi



CODICE	MISURA	A	B	C	D	E	F	G	H	L			
13272722	DN 15 1/2	49	56	27	37	-	G 3/4 EK	R 1/2	-	-	287	10	80

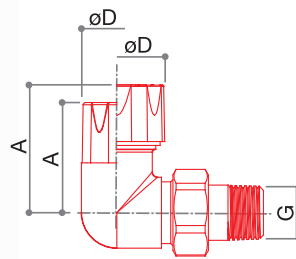

MS 331/A

Detentore di regolazione coassiale sinistro. Attacchi tipo eurocono.

Raccordi



CODICE	MISURA	A	B	C	D	E	F	G	H	L			
13252722	DN 15 1/2	42	56	27	30	-	G 3/4 EK	R 1/2	-	-	258	10	80

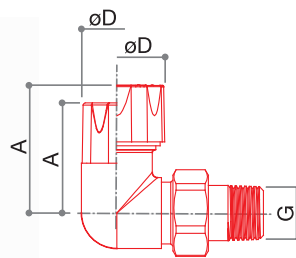

MS 321/A

Valvola radiatore coassiale sinistra termostattabile o elettrocomandabile con cappuccio di protezione. Attacco tipo eurocono.

Raccordi



CODICE	MISURA	A	B	C	D	E	F	G	H	L			
13292722	DN 15 1/2	49	56	27	37	-	G 3/4 EK	R 1/2	-	-	287	10	80

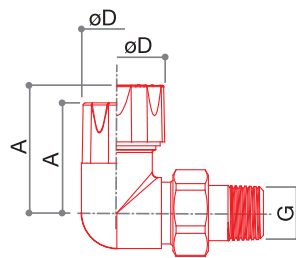

MD 331/A

Detentore di regolazione coassiale destro. Attacco tipo eurocono.

Raccordi



CODICE	MISURA	A	B	C	D	E	F	G	H	L			
13232722	DN 15 1/2	42	56	27	30	-	G 3/4 EK	R 1/2	-	-	258	10	80



TT 3000

TESTA TERMOSTATICA



* UNI EN 215
Approved



CARATTERISTICHE TECNICHE



Max temperatura
120 °C



Max pressione
10 bar



Max pressione
differenziale
0,6 bar

Temperatura min. di regolazione (pos. antigelo)

Ts min 6 °C

Temperatura max di regolazione (pos. max)

Ts max 30 °C (5)

Condizioni di risparmio

20 °C

Campo di inalterabilità dell'elemento termostatico

-15 °C ÷ 60 °C

Temperatura di stoccaggio

-20 °C ÷ + 50 °C

Isteresi

C 0,4 k

Influenza della pressione

D 0,5 k

Influenza della temperatura dell'acqua

W 0,25 k

Tempo di risposta

Z 22 min.

Control Accuracy

CA 0,2 K.

ATTACCO VALVOLA



M 30 x 1,5

Disponibile anche
con finitura cromata
(capitolo Serie 50th)



CHROME

WHITE-CHROME

BLACK

CARATTERISTICHE COSTRUTTIVE

Le teste termostatiche sono costituite da un sensore riempito con un elemento ad alta espansibilità.

L'elemento, che si trova all'interno della manopola di regolazione o nel sensore a distanza, è in grado di dilatarsi o ridursi proporzionalmente all'aumento o alla diminuzione di temperatura ambiente, registrando anche minime variazioni.

Quando la temperatura circostante aumenta, l'elemento si espande e, attraverso il movimento assiale di spinta, influenza la posizione dell'otturatore, controllando così l'azione della valvola.

Con la chiusura e l'apertura della valvola è possibile regolare il flusso del fluido termovettore.

CARATTERISTICHE TECNICHE IN ABBINAMENTO CON LA TESTA TT 3000

POS	ARTICOLI	Kv Δt 1 °C	Kv ΔT 1 °C	qmN (Kg/h)	qm max (Kg/h)	a
1	RS 202 DN 15 - RS 206 DN 15	0.07	0.07	23±65%	32	0.42
2	RS212 DN10 - RS212 DN15 RS209 DN10 - RS209 DN15	0.20	0.25	80±40%	100	0.36
3	RS212/A DN15 - RS209/A DN15	0.24	0.36	113±30%	155	0.46
4	RS2502 DN15 - RS2506 DN15 RS2512 DN10 - RS2512 DN15	0.24	0.37	116±20%	180	0.57
5	RS2509 DN10 - RS2509 DN15	0.24	0.40	128±20%	250	0.74
6	RS2512/A DN15 - RS2509/A DN15	0.32	0.52	165±10%	440	0.84

CAMPO DI REGOLAZIONE

Con l'impiego delle valvole termostatiche si ha la possibilità di rendere ogni locale autonomo con una specifica temperatura impostata aumentando così il comfort ambientale oltre ad un effettivo risparmio energetico come richiesto dalle normative nazionali ed internazionali.

Le teste termostatiche hanno la possibilità di mantenere una temperatura di antigelo nella posizione "❄", questo è molto utile quando non si utilizzano locali e si vuole comunque evitare il problema di danni causati dal gelo. Durante il periodo estivo, invece, è consigliabile posizionare le teste sulla massima apertura "5".

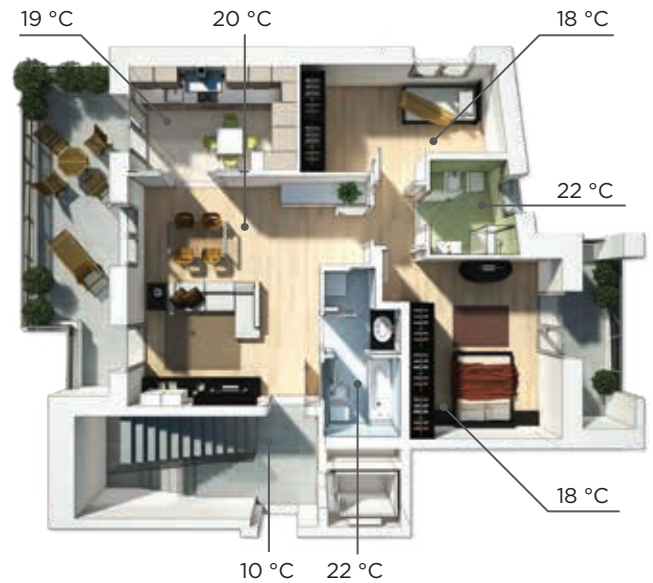
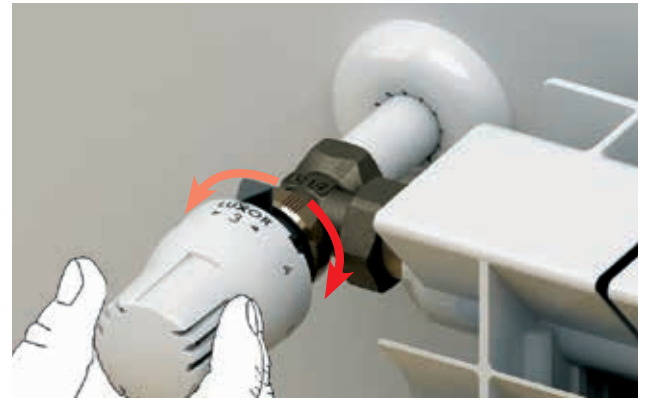
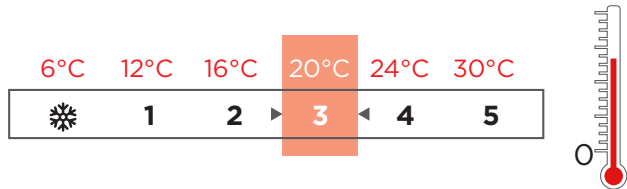

ISTRUZIONI DI UTILIZZO

Prima di procedere all'installazione della testa termostatica, portare il selettore in posizione "5", in modo da facilitare le successive operazioni di installazione.

Successivamente svitare il cappuccio di protezione in ABS bianco RAL 9016 montato sulle valvole termostattabili serie ThermoTekna. Avvitare sullo stesso filetto del corpo della ghiera in ottone della testa termostatica. Quindi posizionare il selettore alla temperatura desiderata.



LIMITAZIONI E BLOCCO DELLA TEMPERATURA



Utilizzando il perno a forcella apposito si può limitare o bloccare la temperatura della testa.

Se si vuole bloccare la regolazione al valore "3" si deve, per prima cosa, ruotare la testa fino al raggiungimento della posizione desiderata. Nella parte inferiore, diametralmente opposto all'indice, è presente una linguetta.

Inserendo il perno a cavallo di questa linguetta si avrà il blocco della temperatura (fig. 1).

Inserendo il perno a sinistra della linguetta si avrà una limitazione che andrà dal valore "3" al valore "5" (fig. 2) mentre inserendolo a destra avremo una limitazione dal valore "3" al valore "❄" (fig. 3).

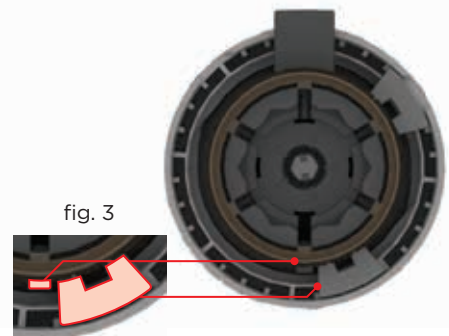
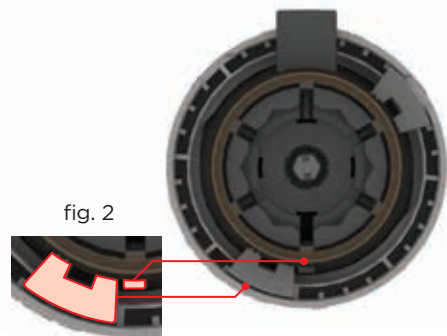
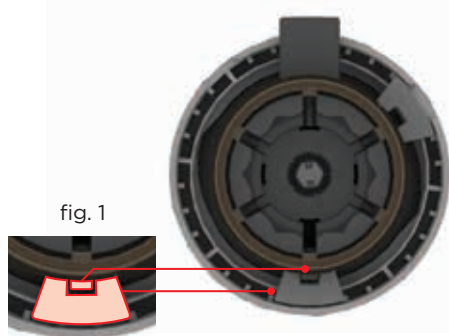

AVVERTENZE PER L'INSTALLAZIONE



Le teste termostatiche **TT 3000** possono essere applicate a tutti i corpi scaldanti liberi di trasmettere il calore nell'ambiente. Nel caso ci siano barriere, come mensole, tendaggi o mobili, che possono immagazzinare calore e quindi falsare la rilevazione della temperatura ambiente da parte delle teste termostatiche, devono essere utilizzate teste termostatiche con sensore a distanza **TT 3002**.

In un impianto dove tutti i corpi scaldanti sono comandati da teste termostatiche, è opportuno inserire una valvola di bypass. Questa ha il compito di evitare la formazione di possibili rumori dovuti alla differenza di pressione troppo elevata che si può verificare all'interno delle valvole termostatiche.

Le teste termostatiche devono essere installate fuori dai flussi di calore che circondano gli elementi riscaldanti (fig. 1) e al riparo da raggi solari (fig. 2).

Evitare quindi di installare la testa termostatica sotto i ripiani (fig. 3) o in nicchia (fig. 4), all'interno del flusso dell'aria calda (fig. 5) o dietro tende (fig. 6).

Queste installazioni non sono corrette in quanto la testa termostatica valuterrebbe una temperatura diversa da quella presente nella stanza.



Se l'installazione fosse posizionata come in fig. 7 si potrebbe verificare una serie di problematiche. La porta, ovviamente, non si potrebbe aprire completamente e, se non prevista di fermo, potrebbe andare ad impattare con la testa provocandone la rottura e causando danni alla porta stessa.

In questo caso si consiglia di utilizzare una valvola termostattizzabile a corpo reverso come mostrato in fig. 8.

TESTE TERMOSTATICHE

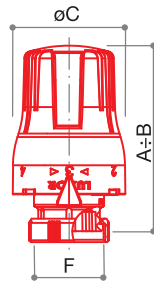

TT 3000

Testa termostatica con comando e sensore incorporato.



CODICE	MISURA	A	B	C	D	E	F	G	H	L			
69100000	M30x1,5	75	80	46,5	-	-	M30x1,5	-	-	-	110	1	100

CODICE	MISURA	A	B	C	D	E	F	G	H	L			
69100000BRA*	M30x1,5	75	80	46,5	-	-	M30x1,5	-	-	-	110	1	100

*Con numerazione Braille

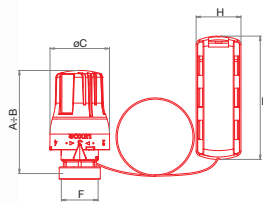

TT 3002

Testa termostatica con comando incorporato e sensore a distanza. Lunghezza standard del capillare trasmettitore 2 m.

CODICE	MISURA	A	B	C	D	E	F	G	H	L			
69100020	M30x1,5	75	80	46,5	-	-	M30x1,5	-	35	96	156	1	32



BT 242

Fascetta antimanomissione e antifurto blocca ghiera per testa TT 3000 e TT 3002.

CODICE	MISURA			
69010402	-	14	5	160

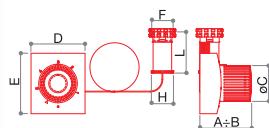

TT 2302

Testa termostatica sottotraccia con comando e sensore a distanza. Lunghezza standard del capillare trasmettitore 2m.

CODICE	MISURA	A	B	C	D	E	F	G	H	L			
69011005	M30x1,5	63	68	45	67	75	M30x1,5	-	28	51	220	1	30



La certificazione delle valvole, secondo la norma UNI EN 215, è intesa come la combinazione valvola e testa termostatica TT 3000 LUXOR. **Tutte le informazioni tecniche sono disponibili su: www.luxor.it**

DIAGRAMMA DI PORTATA VALVOLE

VALVOLE SQUADRA

DN 10 - DN 15

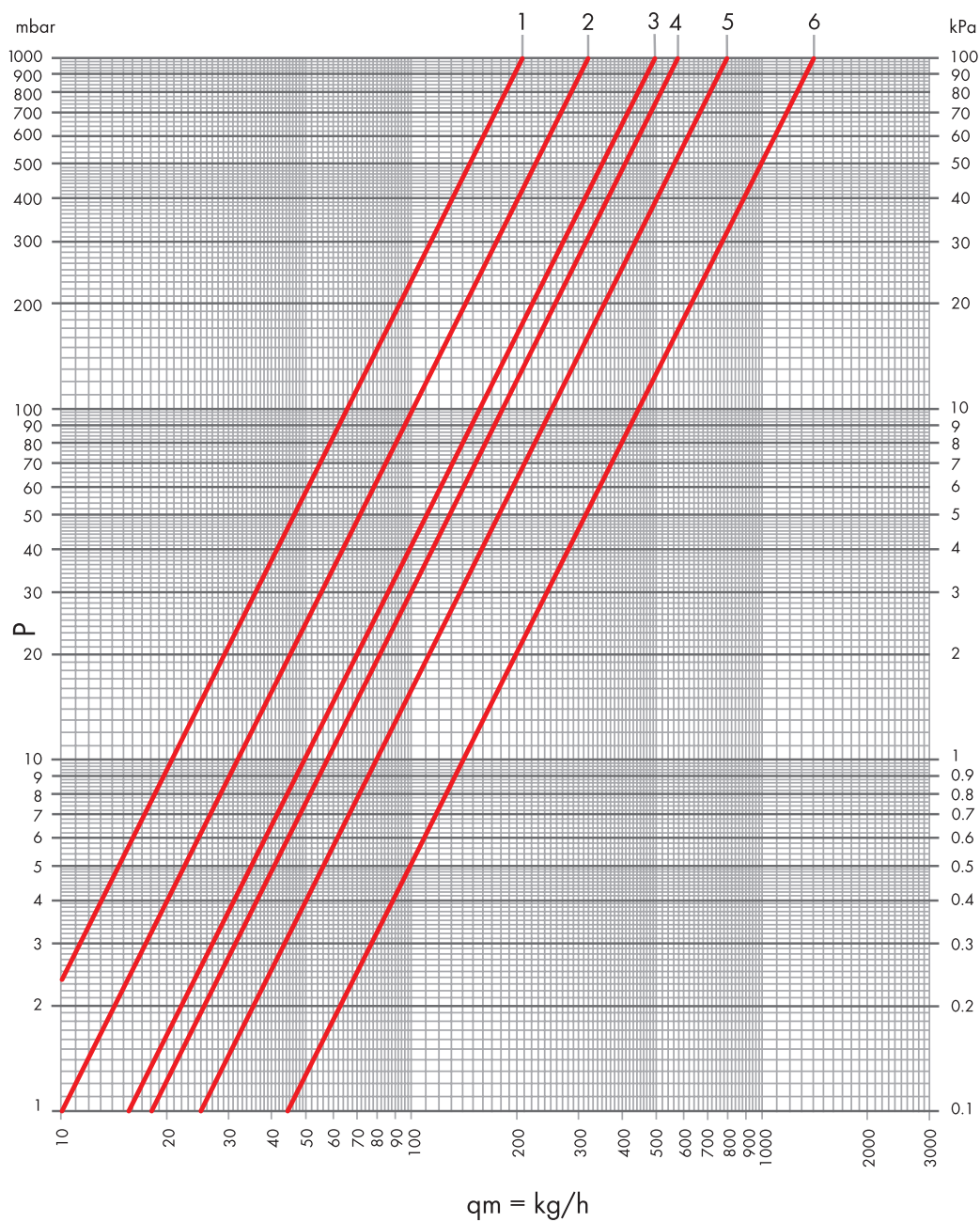

ARTICOLI	Kv	Kv Δt 1 °C	Kv Δt 2 °C	POS
Squadra DN 10 - DN 15	0.10	0.07	0.07	1
	0.32	0.20	0.25	2
	0.49	0.24	0.36	3
	0.57	0.24	0.37	4
	0.79	0.24	0.40	5
	1.39	0.32	0.55	6

DIAGRAMMA DI PORTATA VALVOLE

VALVOLE SQUADRA
DN 20

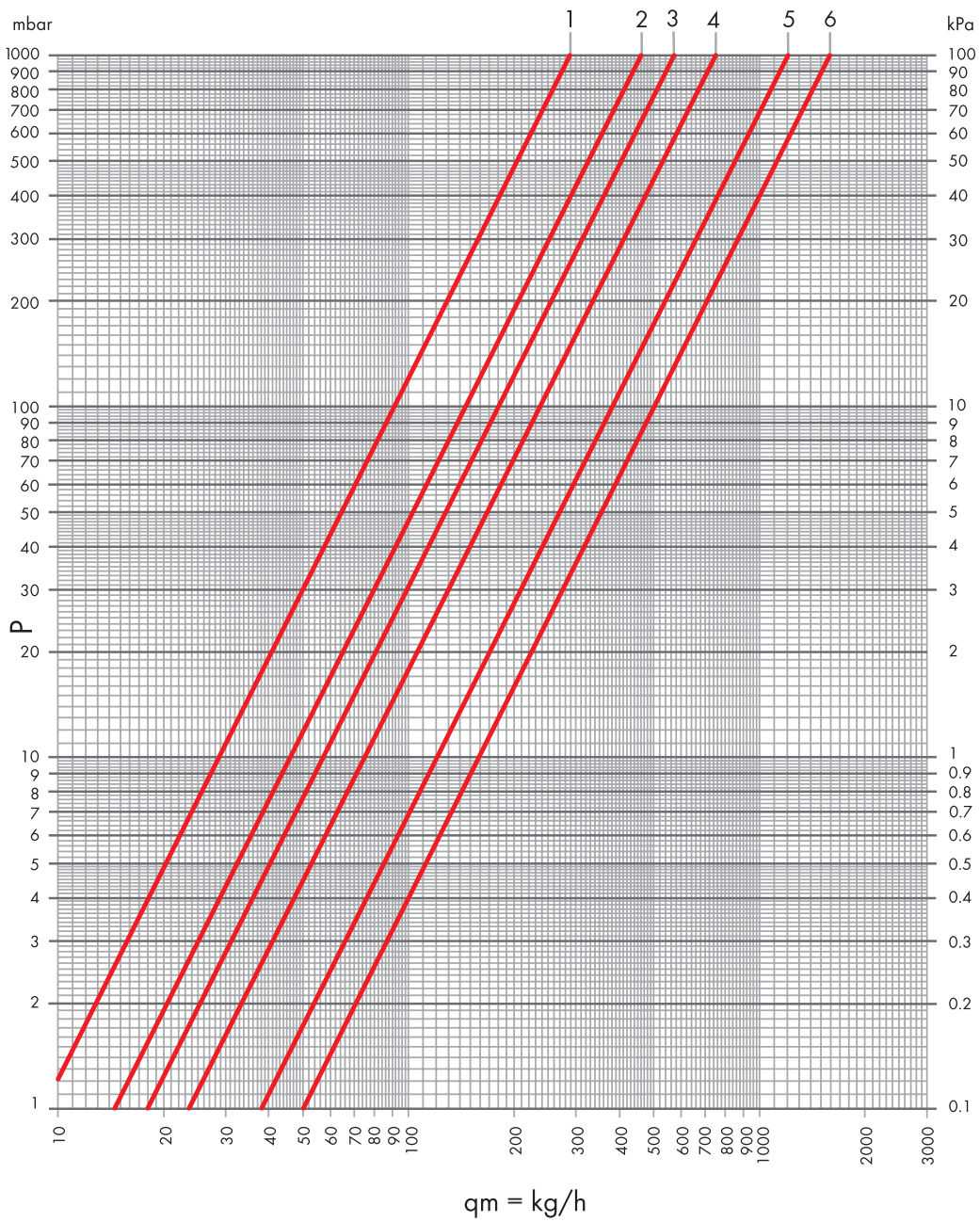

ARTICOLI	Kv	Kv Δt 1 °C	Kv Δt 2 °C	POS
Squadra DN 20	0.29	0.15	0.19	1
	0.49	0.20	0.25	2
	0.57	0.24	0.36	3
	0.75	0.26	0.41	4
	1.20	0.31	0.55	5
	1.58	0.32	0.56	6

DIAGRAMMA DI PORTATA VALVOLE

VALVOLE DIRITTE

DN 10 - DN 15

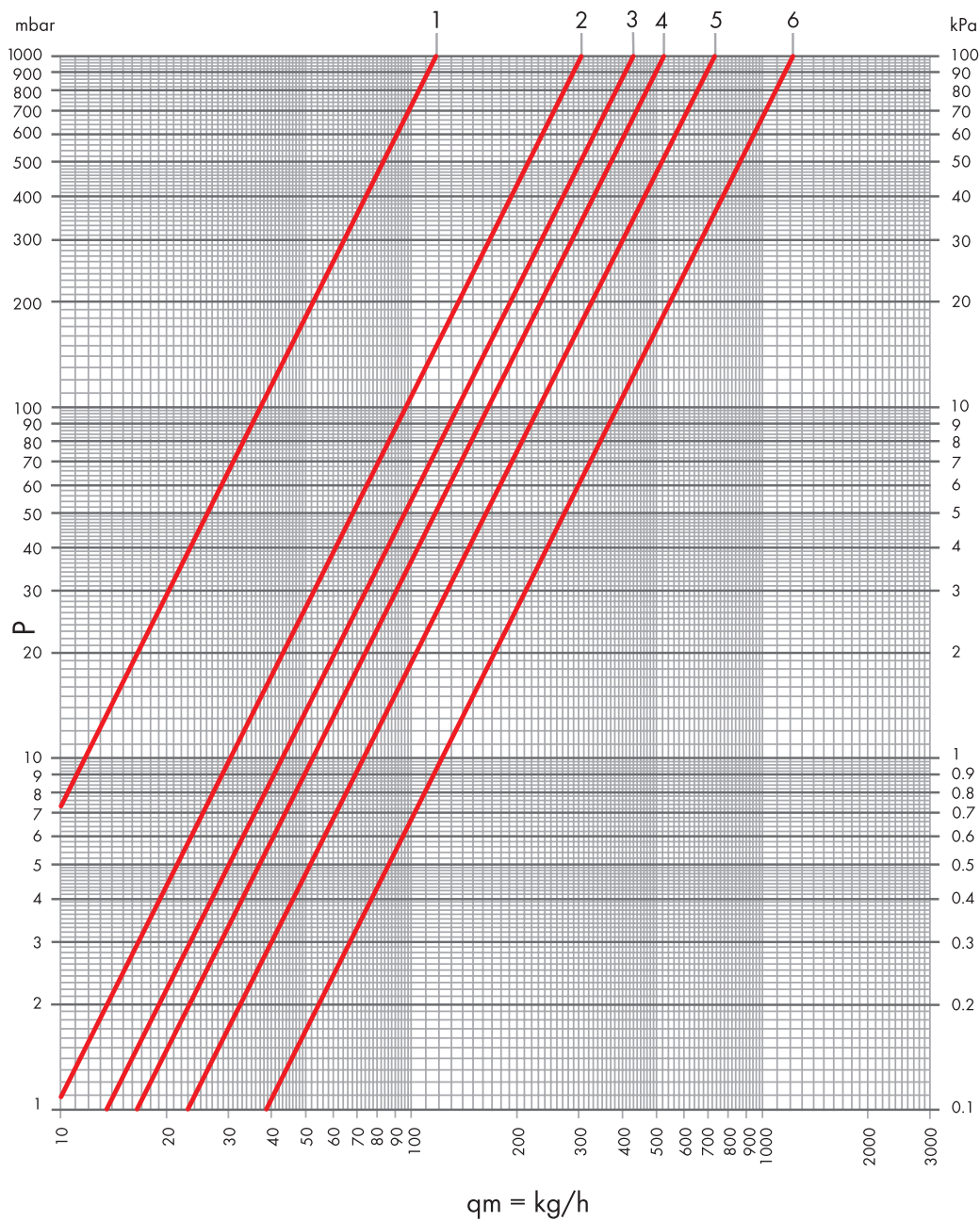

ARTICOLI	Kv	Kv Δt 1 °C	Kv Δt 2 °C	POS
Diritta DN 10 - DN 15	0.12	0.10	0.11	1
	0.30	0.20	0.25	2
	0.43	0.24	0.36	3
	0.52	0.24	0.37	4
	0.72	0.24	0.40	5
	1.21	0.29	0.49	6

DIAGRAMMA DI PORTATA VALVOLE

VALVOLE DIRITTE

DN 20

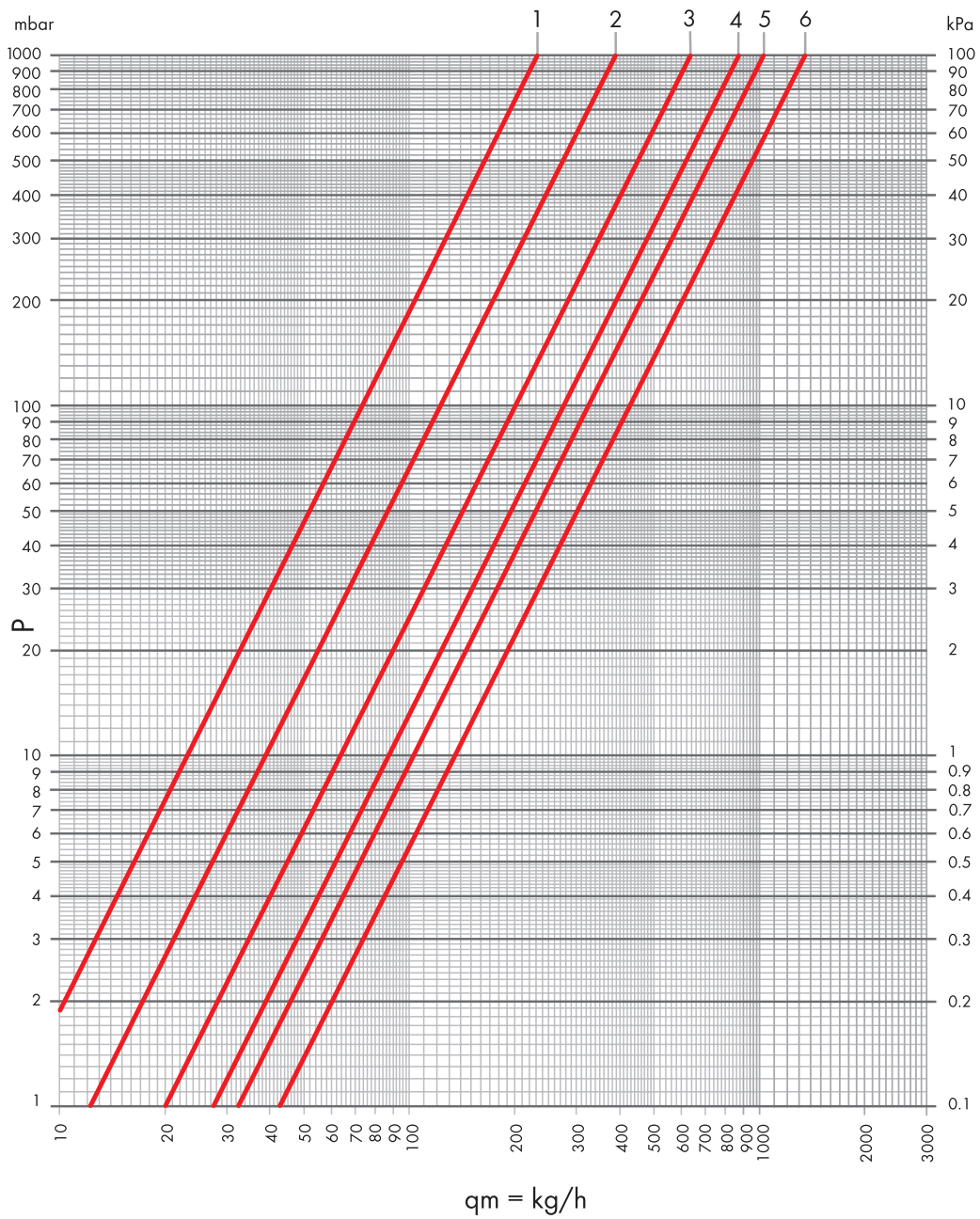

ARTICOLI	Kv	Kv Δt 1 °C	Kv Δt 2 °C	POS
Diritta DN 20	0.23	0.16	0.19	1
	0.39	0.22	0.25	2
	0.63	0.25	0.36	3
	0.87	0.29	0.41	4
	1.02	0.30	0.50	5
	1.34	0.31	0.52	6

DIAGRAMMA DI PORTATA DETENTORE

DETENTORE A SQUADRA

DN 10 3/8

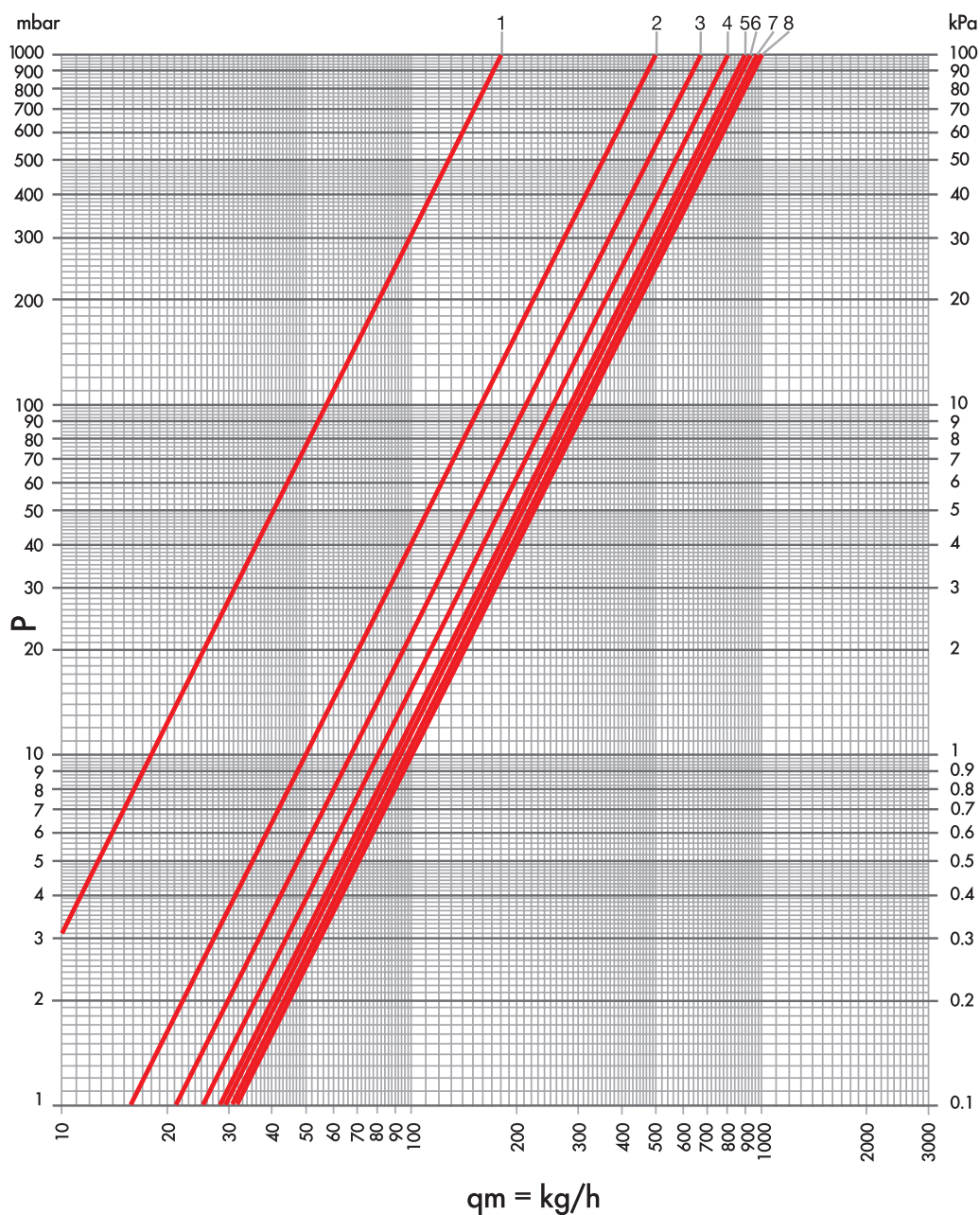

ARTICOLI	N. GIRI	Kvs	POS
DS 22 DS 26 DS 32 DS 39 DS 32/A DS 39/A	1	0.18	1
	1+1/2	0.50	2
	2	0.67	3
	2+1/2	0.80	4
	3	0.90	5
	3+1/2	0.93	6
	4	0.97	7
	tutto aperto	1.00	8

DIAGRAMMA DI PORTATA DETENTORE

DETENTORE A SQUADRA

DN 15 1/2

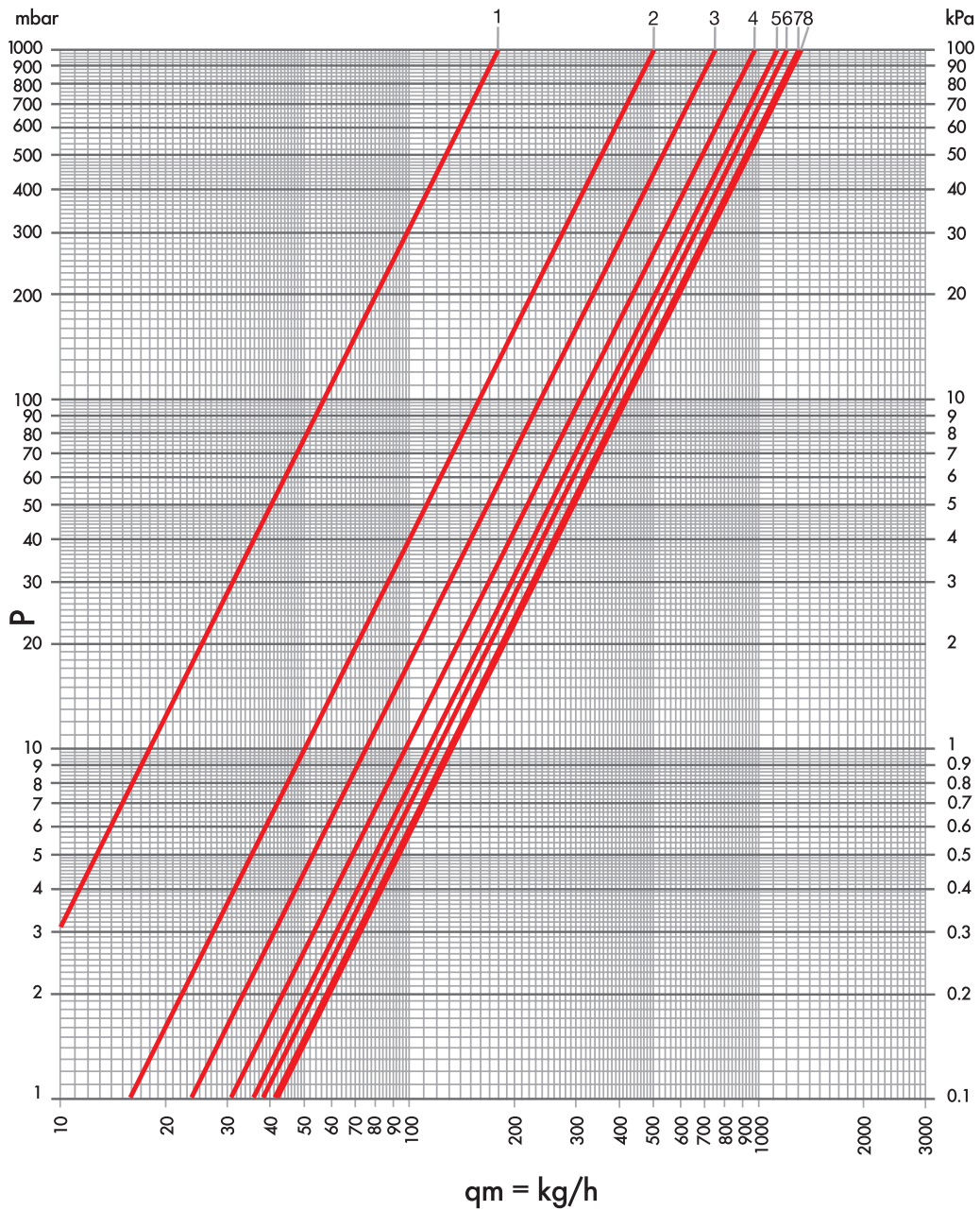

ARTICOLI	N. GIRI	Kvs	POS
DS 22 DS 26 DS 32 DS 39 DS 32/A DS 39/A	1	0.18	1
	1+1/2	0.50	2
	2	0.75	3
	2+1/2	0.97	4
	3	1.12	5
	3+1/2	1.20	6
	4	1.30	7
	tutto aperto	1.31	8

DIAGRAMMA DI PORTATA DETENTORE

DETENTORE A SQUADRA

DN 20 3/4

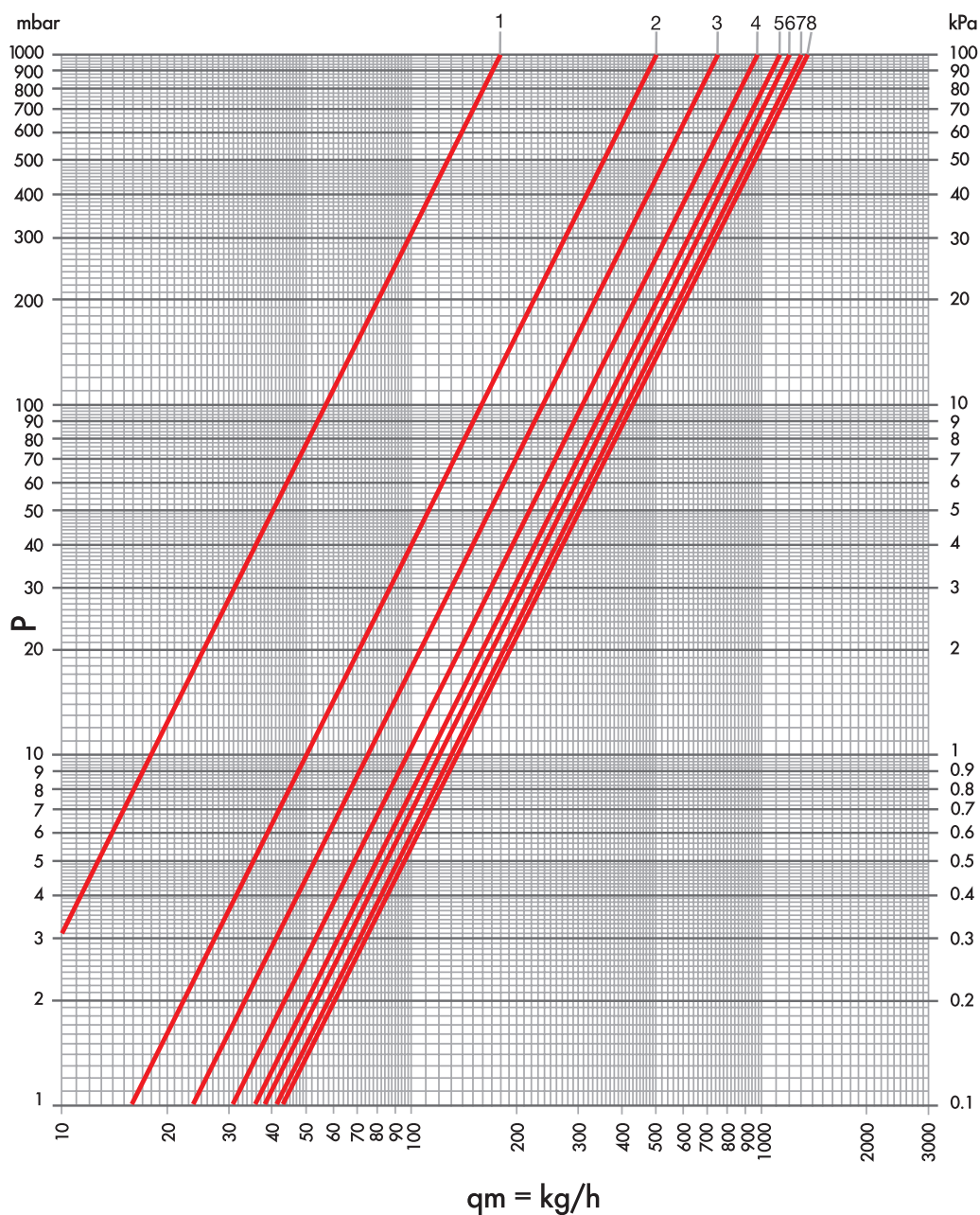

ARTICOLI	N. GIRI	Kvs	POS
DS 22 DS 26 DS 32 DS 39 DS 32/A DS 39/A	1	0.18	1
	1+1/2	0.50	2
	2	0.75	3
	2+1/2	0.97	4
	3	1.12	5
	3+1/2	1.20	6
	4	1.30	7
	tutto aperto	1.34	8

DIAGRAMMA DI PORTATA DETENTORE

DETENTORE DIRITTO

DN 10 3/8

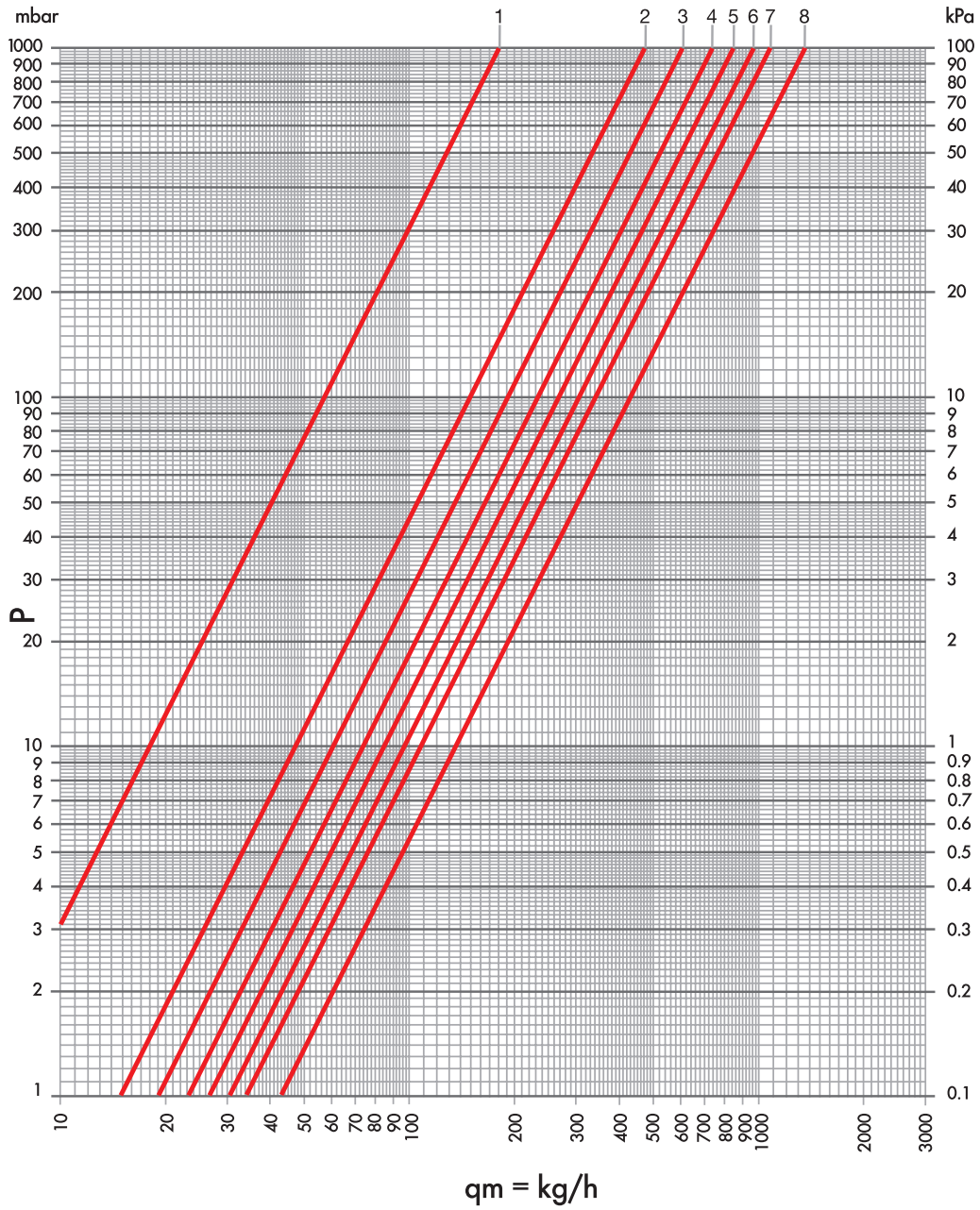

ARTICOLI	N. GIRI	Kvs	POS
DD 21 DD 25 DD 31 DD 38 DD 31/A DD 38/A	1	0.18	1
	1+1/2	0.47	2
	2	0.60	3
	2+1/2	0.73	4
	3	0.84	5
	3+1/2	0.95	6
	4	1.07	7
	tutto aperto	1.34	8

DIAGRAMMA DI PORTATA DETENTORE

DETENTORE DIRITTO

DN 15 1/2

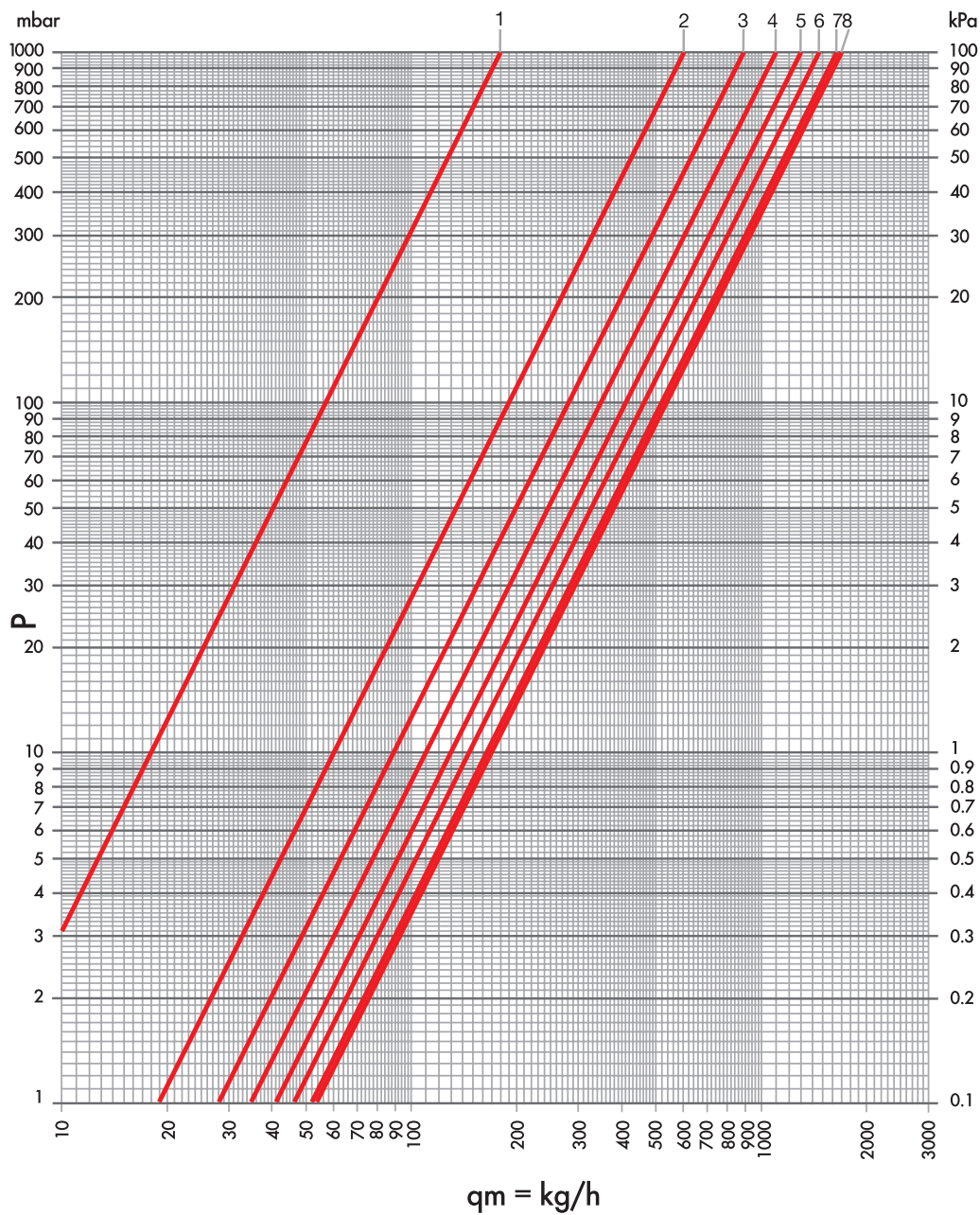

ARTICOLI	N. GIRI	Kvs	POS
DD 21 DD 25 DD 31 DD 38 DD 31/A DD 38/A	1	0.18	1
	1+1/2	0.60	2
	2	0.89	3
	2+1/2	1.10	4
	3	1.30	5
	3+1/2	1.46	6
	4	1.63	7
	tutto aperto	1.70	8

DIAGRAMMA DI PORTATA DETENTORE

DETENTORE DIRITTO

DN 20 3/4

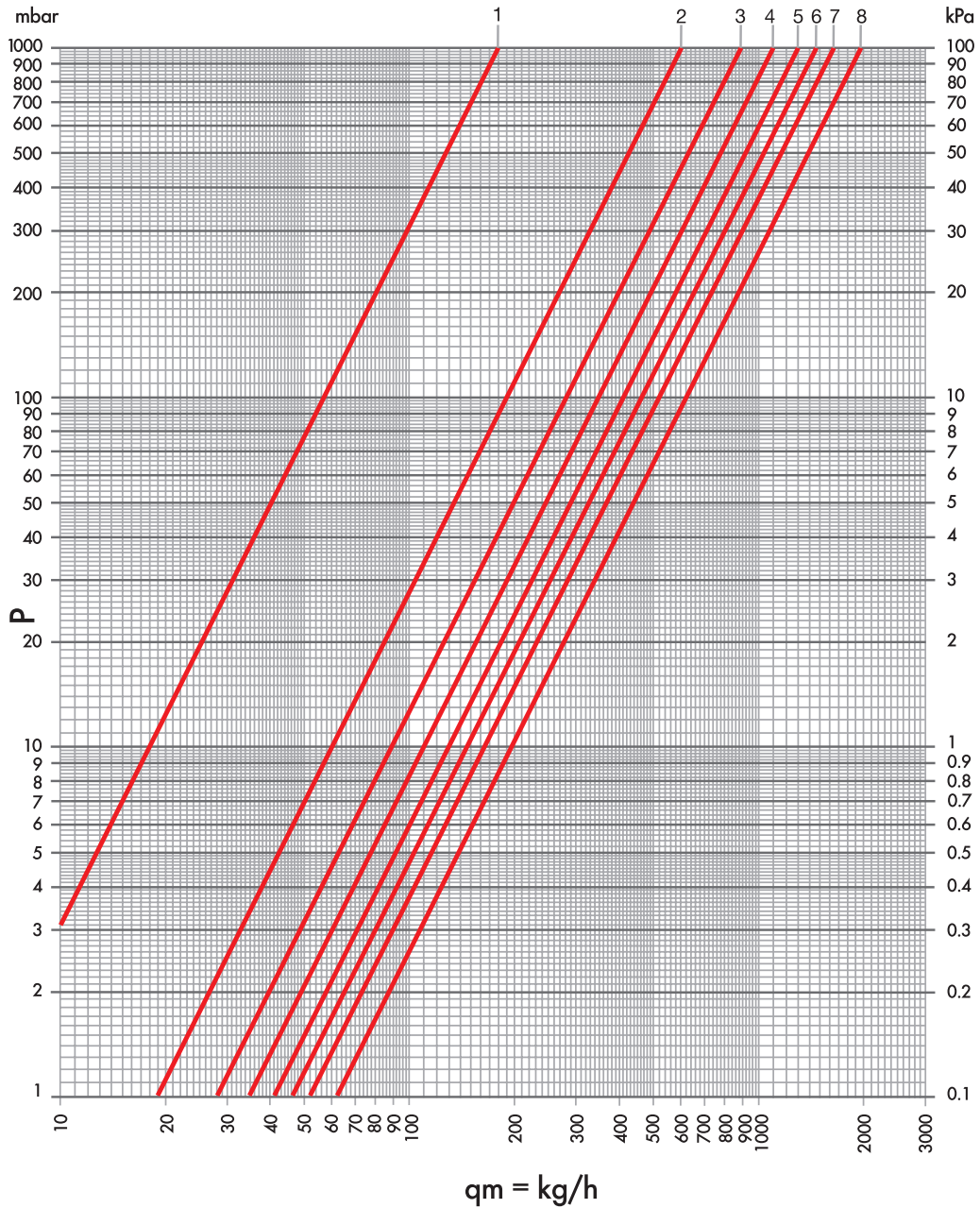

ARTICOLI	N. GIRI	Kvs	POS
DD 21 DD 25 DD 31 DD 38 DD 31/A DD 38/A	1	0.18	1
	1+1/2	0.60	2
	2	0.89	3
	2+1/2	1.10	4
	3	1.30	5
	3+1/2	1.46	6
	4	1.63	7
	tutto aperto	1.96	8



LUXOR®

VALVOLE RADIATORE

1.3 / SERIE 30

SERIE 30 VALVOLE PER RADIATORE



Le valvole Serie 30 hanno un vitone che offre la possibilità di prerogolazione grazie ad un anello in acetalica sagomato. Il vitone termostatico permette la sostituzione di uno degli o-ring di tenuta sull'asta di comando senza che sia necessario svuotare l'impianto. Le valvole sono prodotte con finitura cromata.



I detentori serie 30 hanno la tenuta assicurata da un o-ring sull'otturatore e se necessario da un ulteriore o-ring tra il corpo e il tappo. La tenuta in chiusura con l'otturatore è assicurata da un o-ring e da una tenuta conica metallica. Tutti i detentori hanno la possibilità di regolare la portata limitando l'alzata dell'otturatore.



La valvola manuale Serie 30 utilizza un'asta fissa la cui tenuta è garantita da due o-rings. La tenuta in chiusura con l'otturatore è assicurata da un o-ring e da una tenuta conica metallica. L'apertura delle valvole e detentori deve essere effettuata con pressione differenziale inferiore a un 1 bar.

CARATTERISTICHE TECNICHE



DN

15



Max temperatura

120 °C



Max pressione

10 bar



Max pressione differenziale (valvole termostatiche)

0,6 bar



Max pressione differenziale

1 bar



Materiale

CW617N
UNI EN
12165:2016



Manopola

ABS cromato
ABS bianco
RAL 9016



Asta di comando

AISI 316



Collaudo

100%

ATTACCHI IMPIANTO



Tubo ferro
(valvole manuali)
G 1/2

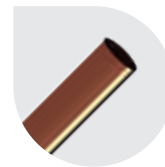

Tubo rame
G 3/4 EK - TR 91/AC



Tubo plastica
G 3/4 EK - TP 98/C



Tubo multistrato
G 3/4 EK - TP 99/C

COLLEGAMENTO RADIATORE



filetto cilindrico con tenuta morbida
G 1/2

REGOLAZIONE DELLA PORTATA E REVERSE FLOW

Per regolare la massima portata della valvola si deve agire nel seguente modo:

- allineare la tacca di riferimento presente sull'asta in acciaio inox con una delle posizioni stampate sul corpo della valvola.

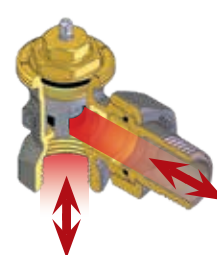
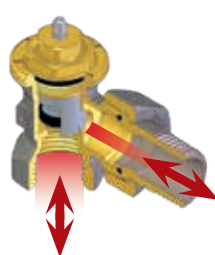
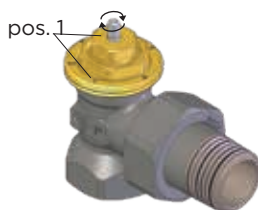

Le valvole termostatiche Luxor possono funzionare anche in condizione di flusso inverso. Grazie a questa caratteristica possono essere installate sia sulla mandata sia sul ritorno del radiatore fino ad una pressione differenziale di 0,6 bar.

Tutte le valvole e i detentori vengono testati al 100% con prova di tenuta pneumatica a controllo elettronico.

Le caratteristiche del fluido dell'impianto devono essere conformi alla direttiva UNI 8065:2019.

ATTACCO TUBO FERRO



CHROME

WHITE-CHROME

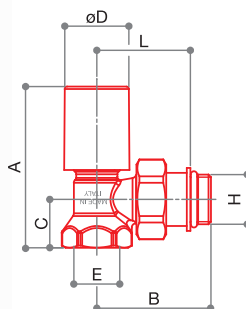
**KT 146**

Kit manuale squadra completo per collegamento ai termoarredi. Composto da due RS 146. Attacco tubo ferro.

Raccordi



CODICE	MISURA	FINITURA	A	B	C	D	E	F	G	H	L			
20822103	DN 15 1/2	CHROME	67	47	20	27	G 1/2	-	-	G 1/2	39	343	1	32
20822103CB	DN 15 1/2	WHITE-CHROME	67	47	20	27	G 1/2	-	-	G 1/2	39	343	1	32

ATTACCO TUBO RAME E TUBO PLASTICA G3/4 EUROCONO



CHROME

WHITE-CHROME

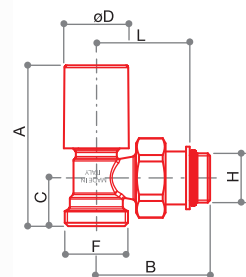
**KT 159/A**

Kit manuale squadra completo per collegamento ai termoarredi. Composto da due RS 159/A. Attacco tipo G 3/4 eurocono.

Raccordi



CODICE	MISURA	FINITURA	A	B	C	D	E	F	G	H	L			
20842703	DN 15 1/2	CHROME	67	47	20	27	-	G 3/4 EK	-	G 1/2	39	340	1	32
20842703CB	DN 15 1/2	WHITE-CHROME	67	47	20	27	-	G 3/4 EK	-	G 1/2	39	340	1	32



CHROME

WHITE-CHROME

KT 2509/A

Kit termostatico squadra completo per collegamento ai termoarredi. Composto da: RS 2509/A + DS 89/A. Attacco tipo G 3/4 eurocono.

Raccordi



CODICE	MISURA	FINITURA			
20742703	DN 15 1/2	CHROME	380	1	32
20742703CB	DN 15 1/2	WHITE-CHROME	380	1	32

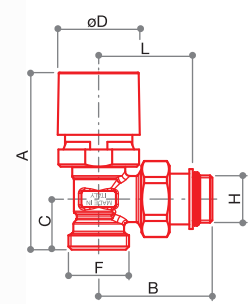

RS 2509/A

Valvola radiatore a squadra termostattizzabile o elettrocomandabile con volantino di comando manuale a semplice regolazione. Attacco tipo G 3/4 eurocono.

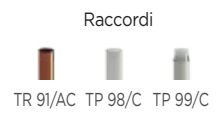

CODICE	MISURA	FINITURA	A	B	C	D	E	F	G	H	L			
20722703	DN 15 1/2	CHROME	77	49	22	36	-	G 3/4 EK	-	G 1/2	41	203	10	80
20722703CB	DN 15 1/2	WHITE-CHROME	77	49	22	36	-	G 3/4 EK	-	G 1/2	41	203	10	80

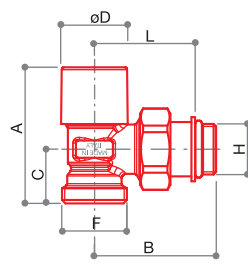

DS 89/A

Detentore di regolazione a squadra. Attacco tipo G 3/4 eurocono.

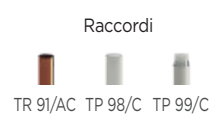

CODICE	MISURA	FINITURA	A	B	C	D	E	F	G	H	L			
20162703	DN 15 1/2	CHROME	55	49	22	27	-	G 3/4 EK	-	G 1/2	41	168	10	80
20162703CB	DN 15 1/2	WHITE-CHROME	55	49	22	27	-	G 3/4 EK	-	G 1/2	41	168	10	80

DIAGRAMMA DI PORTATA VALVOLE

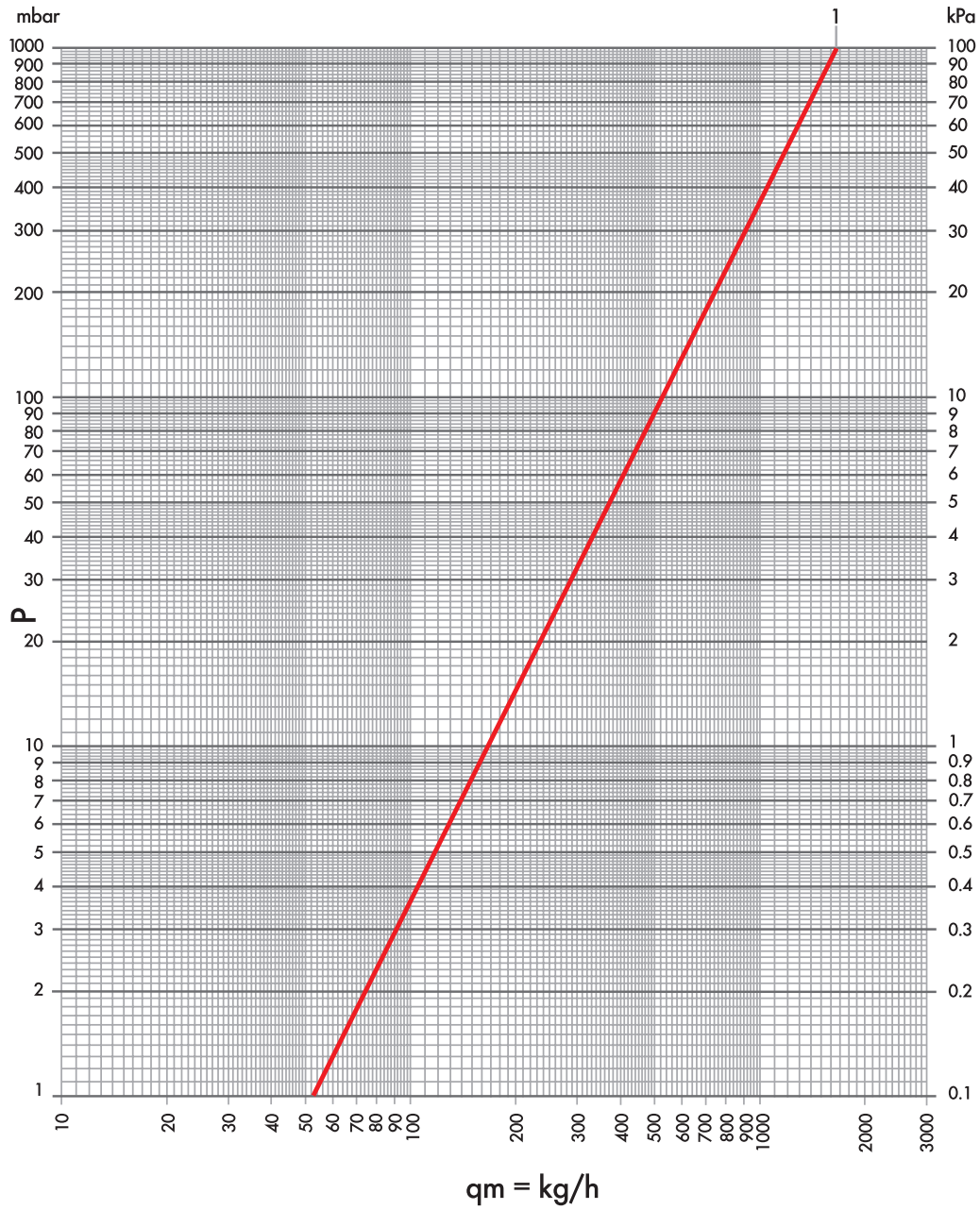

ARTICOLI	Kv	POS
RS 159/A 1/2	1,65	1

DIAGRAMMA DI PORTATA VALVOLE

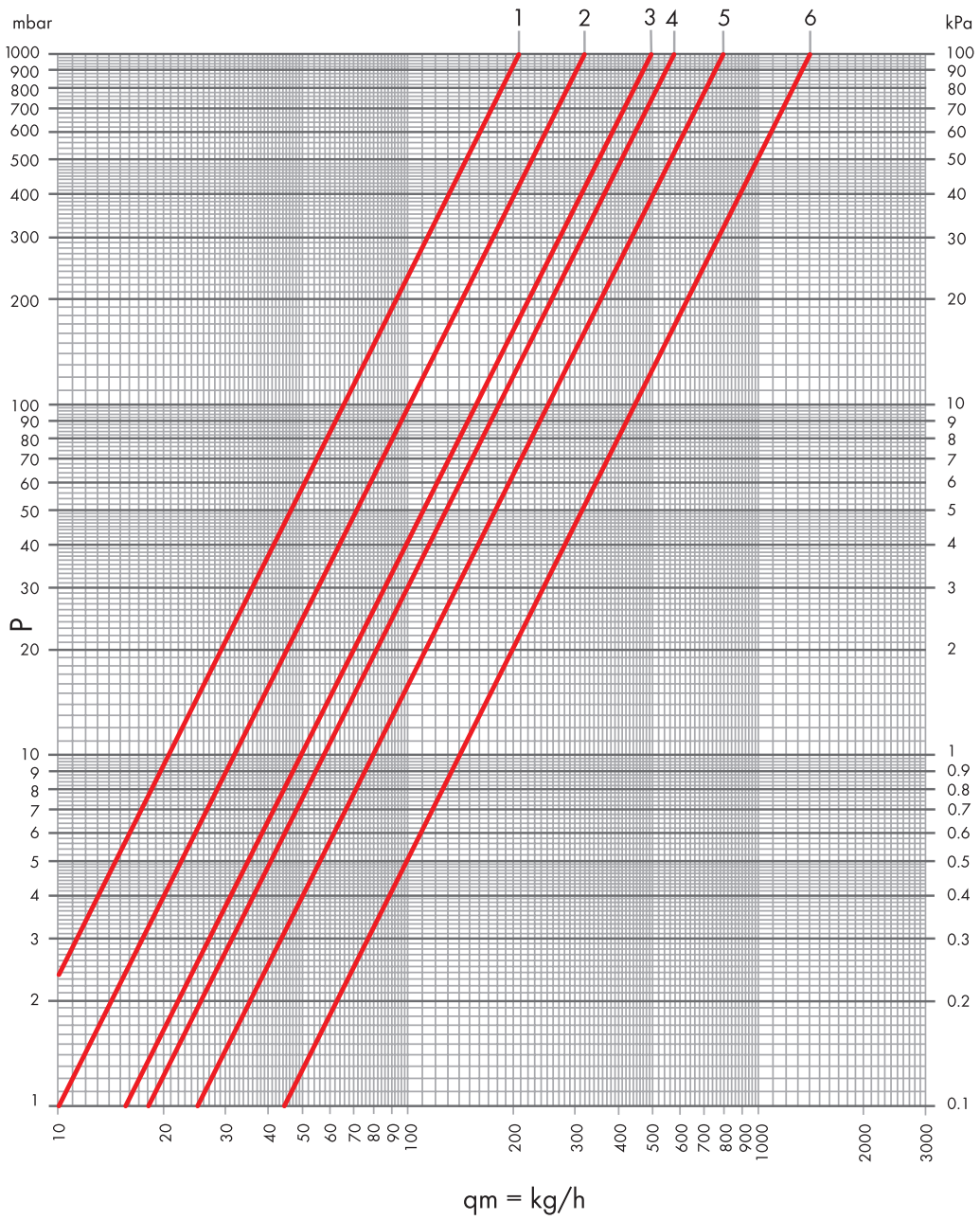

ARTICOLI	Kv	Kv Δt 1 °C	Kv Δt 2 °C	POS
RS 2509/A	0,10	0,07	0,07	1
	0,32	0,2	0,25	2
	0,49	0,24	0,36	3
	0,57	0,24	0,37	4
	0,79	0,24	0,40	5
	1,39	0,32	0,55	6

DIAGRAMMA DI PORTATA DETENTORE

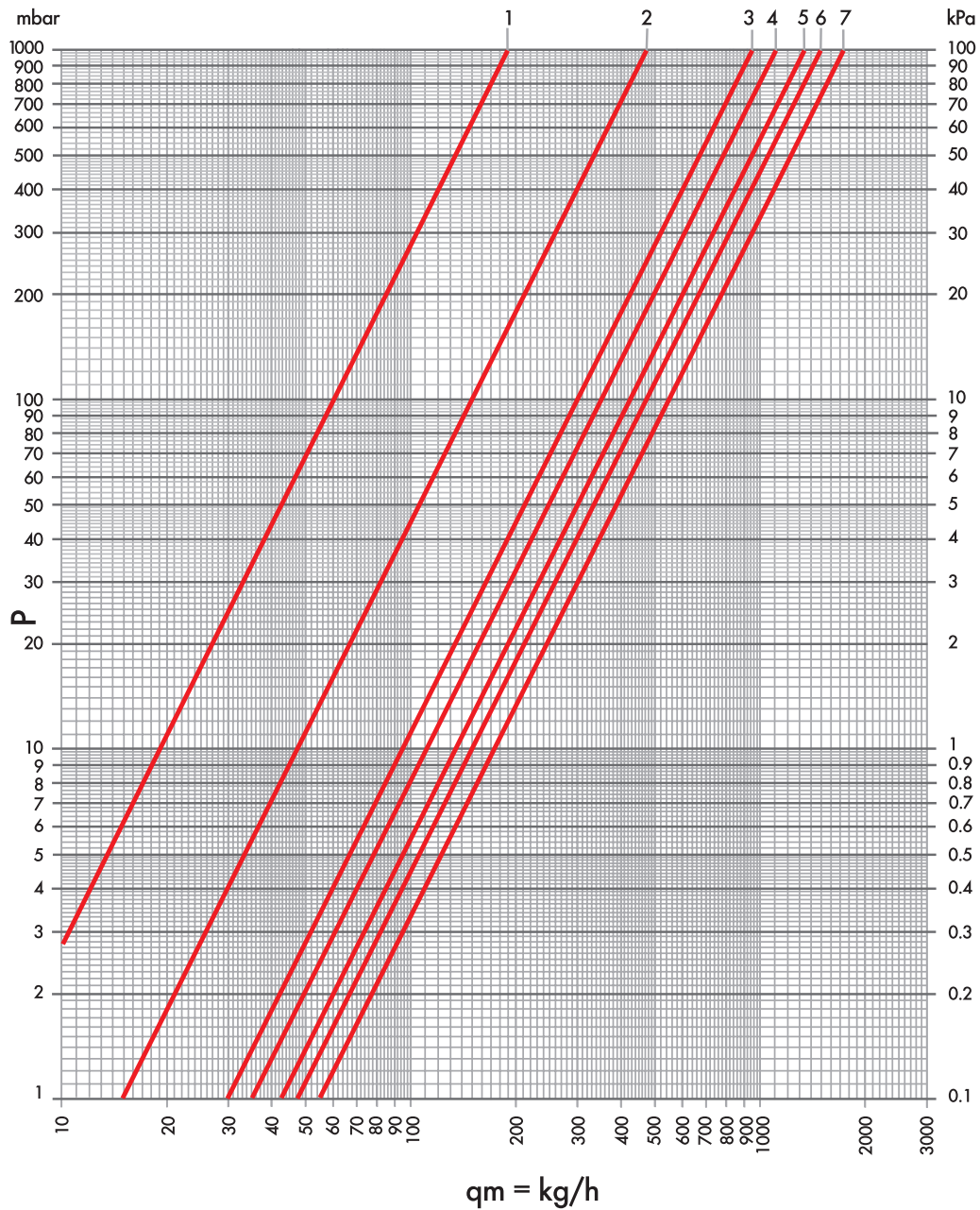

ARTICOLI	N. GIRI	Kv	POS
DS 89/A	1	0,19	1
	1+1/2	0,48	2
	2	0,71	3
	2+1/2	0,92	4
	3	1,06	5
	3+1/2	1,18	6
	tutto aperto	1,29	7



LUXOR®

VALVOLE RADIATORE

1.4 / SERIE 50th

SERIE 50th

VALVOLE PER RADIATORE



Le valvole serie 50th hanno un vitone che offre la possibilità di preregolazione grazie ad un anello in acetilica sagomato. Il vitone termostatico permette la sostituzione di uno degli o-ring di tenuta sull'asta di comando senza che sia necessario svuotare l'impianto.



I detentori serie 50th hanno la tenuta assicurata da un o-ring sull'otturatore e se necessario da un ulteriore o-ring tra il corpo e il tappo. La tenuta in chiusura con l'otturatore è assicurata da un o-ring e da una tenuta conica metallica. Tutti i detentori hanno la possibilità di regolare la portata limitando l'alzata dell'otturatore.



La valvola manuale serie 50th utilizza un'asta fissa la cui tenuta è garantita da due o-rings. La tenuta in chiusura con l'otturatore è assicurata da una guarnizione piatta. L'apertura delle valvole e detentori deve essere effettuata con pressione differenziale inferiore a un 1 bar.

CARATTERISTICHE TECNICHE



DN

15



Max temperatura

120 °C



Max pressione

10 bar



Max pressione differenziale (valvole termostatiche)

0,6 bar



Max pressione differenziale

1 bar



Materiale

CW617N
UNI EN
12165:2016



Manopola

ABS cromato
ABS bianco
RAL 9016



Asta di comando

AISI 316

ATTACCHI IMPIANTO

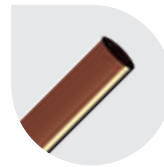

Tubo rame
G 3/4 EK - TR 91/AC

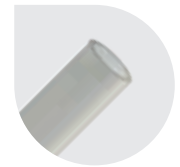

Tubo plastica
G 3/4 EK - TP 98/C



Tubo multistrato
G 3/4 EK - TP 99/C

COLLEGAMENTO RADIATORE



filetto cilindrico con tenuta morbida
G 1/2

FINITURA



chrome



white



white-chrome



black

COME SELEZIONARE LE VALVOLE COASSIALI CORRETTE

KIT TERMOSTATICO COASSIALE DESTRA

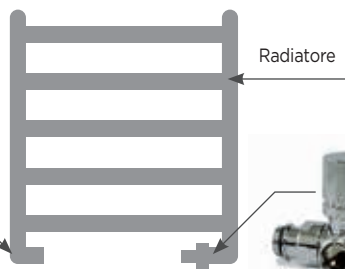

Detentore sinistro

Valvola termostatica o manuale destra

KIT TERMOSTATICO COASSIALE SINISTRA

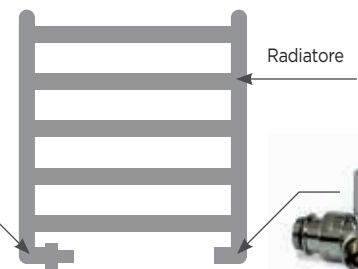

Valvola termostatica o manuale sinistra

Detentore destro

Le caratteristiche del fluido dell'impianto devono essere conformi alla direttiva UNI 8065:2019.

REGOLAZIONE DELLA PORTATA

Per regolare la massima portata della valvola si deve agire nel seguente modo:

- allineare la tacca di riferimento presente sull'asta in acciaio inox con una delle posizioni stampate sul corpo della valvola.

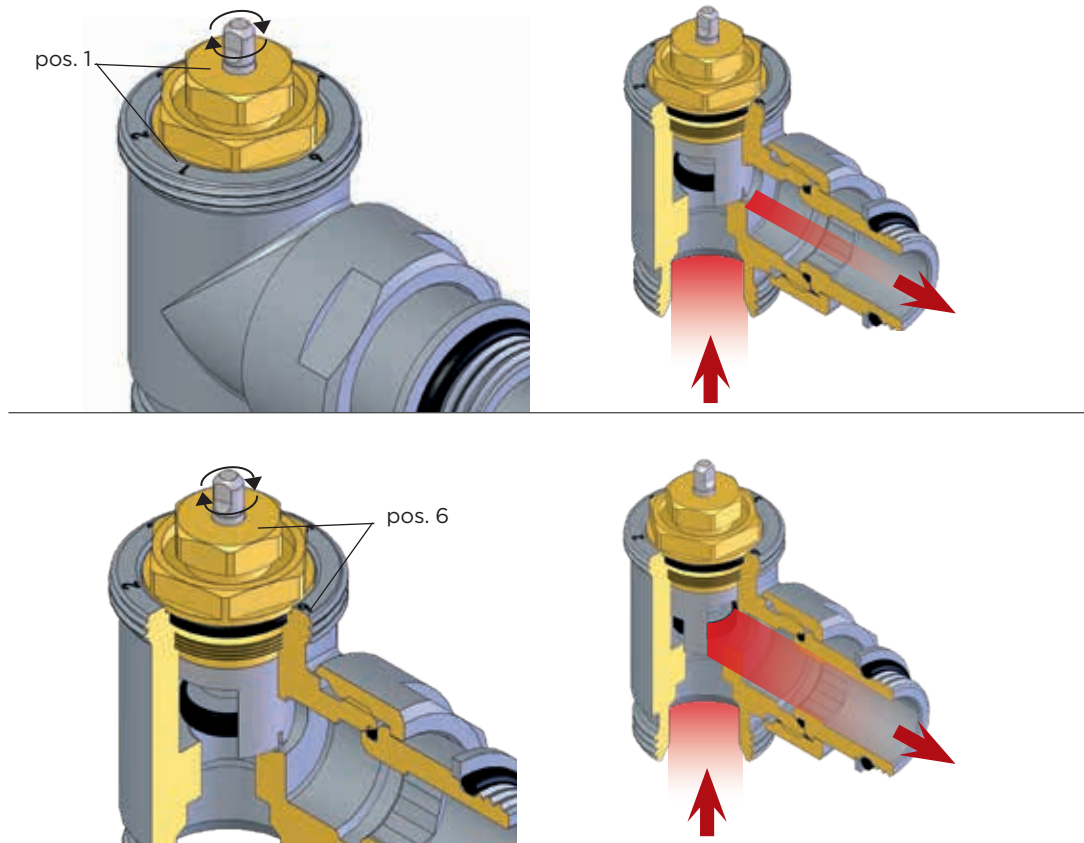

TENUTA SULLO STELO

Il sistema di tenuta può essere facilmente sostituito senza svuotare l'impianto:

- svitare la ghiera con testa esagonale con una chiave a stella da 13 mm;

- togliere l'o-ring "art. 582 - cod. 3424602", pulire l'asta in inox e inserire un nuovo o-ring "art. 582";
- montare la ghiera avvitando a fondo.



SOSTITUZIONE DEL VITONE

Grazie all'art. CH 111 - cod. 67822719 il vitone può essere sostituito senza svuotare l'impianto e con questo in funzione.

KIT TERMOSTATICI: ATTACCO TUBO RAME E TUBO PLASTICA G3/4 EUROCONO



CHROME



WHITE-CHROME
ARTICOLO IN ESAURIMENTO



WHITE

KT 259/A

Kit termostatico squadra completo per collegamento ai termoarredi. Composto da: RS 259/A + DS 79/A + TT 3000. Attacco tipo eurocono.

CODICE	MISURA	FINITURA						
14702703	DN 15 1/2	CHROME	TR 91/AC	TP 98/C	TP 99/C	603	1	12
14702703CB	DN 15 1/2	WHITE-CHROME	TR 91/AC	TP 98/C	TP 99/C	604	1	12
14702703B	DN 15 1/2	WHITE	TR 91/AC	TP 98/C	TP 99/C	604	1	12



CHROME



WHITE-CHROME
ARTICOLO IN ESAURIMENTO



WHITE

KT 258/A

Kit termostatico diritto completo per collegamento ai termoarredi. Composto da: RD 258/A + DD 78/A + TT 3000. Attacco tipo eurocono.

CODICE	MISURA	FINITURA						
14902703	DN 15 1/2	CHROME	TR 91/AC	TP 98/C	TP 99/C	663	1	12
14902703CB	DN 15 1/2	WHITE-CHROME	TR 91/AC	TP 98/C	TP 99/C	664	1	12
14902703B	DN 15 1/2	WHITE	TR 91/AC	TP 98/C	TP 99/C	664	1	12



CHROME



WHITE-CHROME
ARTICOLO IN ESAURIMENTO



WHITE

KT 269/A

Kit termostatico coassiale destra completo per collegamento ai termoarredi. Composto da: RCD 269/A + DCS 33/A + TT 3000. Attacco tipo eurocono.

CODICE	MISURA	FINITURA						
14772703	DN 15 1/2	CHROME	TR 91/AC	TP 98/C	TP 99/C	655	1	12
14772703CB	DN 15 1/2	WHITE-CHROME	TR 91/AC	TP 98/C	TP 99/C	658	1	12
14772703B	DN 15 1/2	WHITE	TR 91/AC	TP 98/C	TP 99/C	658	1	12



CHROME

WHITE-CHROME
ARTICOLO IN ESAURIMENTO

WHITE

KT 273/A

Kit termostatico coassiale sinistra completo per collegamento ai termoarredi.
Composto da: RCS 273/A + DCD 29/A + TT 3000. Attacco tipo eurocono.

CODICE	MISURA	FINITURA						
14792703	DN 15 1/2	CHROME	TR 91/AC	TP 98/C	TP 99/C	655	1	12
14792703CB	DN 15 1/2	WHITE-CHROME	TR 91/AC	TP 98/C	TP 99/C	658	1	12
14792703B	DN 15 1/2	WHITE	TR 91/AC	TP 98/C	TP 99/C	658	1	12



CHROME

WHITE-CHROME
ARTICOLO IN ESAURIMENTO

WHITE



BLACK

KT 2059/A

Kit termostatico squadra completo per collegamento ai termoarredi.
Composto da: RS 2059/A + DS 79/A. Attacco tipo eurocono.

CODICE	MISURA	FINITURA						
14742703	DN 15 1/2	CHROME	TR 91/AC	TP 98/C	TP 99/C	503	1	12
14742703CB	DN 15 1/2	WHITE-CHROME	TR 91/AC	TP 98/C	TP 99/C	507	1	12
14742703B	DN 15 1/2	WHITE	TR 91/AC	TP 98/C	TP 99/C	507	1	12
14742703N	DN 15 1/2	BLACK	TR 91/AC	TP 98/C	TP 99/C	507	1	12

Kit con raccordi inclusi.

CODICE	MISURA	FINITURA			
14010001	DN 15 1/2	CHROME	503	1	12
14010001CB	DN 15 1/2	WHITE-CHROME	507	1	12

CODICE	MISURA	FINITURA			
14010001B	DN 15 1/2	WHITE	507	1	12

CODICE	MISURA	FINITURA			
14010001N	DN 15 1/2	BLACK	507	1	12

Raccordo	Codice	Misura
2x	TR 91/AC	67761200C 12 mm
2x	TR 91/AC	67761400C 14 mm
2x	TP 99/C	67861612C 16x2

2x	TR 91/AC	67761200B 12 mm
2x	TR 91/AC	67761400B 14 mm
2x	TP 99/C	67861612B 16x2

2x	TR 91/AC	67761200N 12 mm
2x	TR 91/AC	67761400N 14 mm
2x	TP 99/C	67861612N 16x2



Raccordi per tubo rame



Raccordi per tubo plastica



Raccordi per tubo multistrato



Raccordi: capitolo 7



Accessori: capitolo 1.A



CHROME



WHITE-CHROME
ARTICOLO IN ESAURIMENTO



WHITE

KT 2058/A

Kit termostatico diritto completo per collegamento ai termoarredi. Composto da: RD 2058/A + DD 78/A. Attacco tipo eurocono.

CODICE	MISURA	FINITURA						
14942703	DN 15 1/2	CHROME	TR 91/AC	TP 98/C	TP 99/C	565	1	12
14942703CB	DN 15 1/2	WHITE-CHROME	TR 91/AC	TP 98/C	TP 99/C	567	1	12
14942703B	DN 15 1/2	WHITE	TR 91/AC	TP 98/C	TP 99/C	567	1	12



CHROME



WHITE-CHROME
ARTICOLO IN ESAURIMENTO



WHITE



BLACK

KT 2069/A

Kit termostatico coassiale destra completo per collegamento ai termoarredi. Composto da: RCD 2069/A + DCS 33/A. Attacco tipo eurocono.

CODICE	MISURA	FINITURA						
14812703	DN 15 1/2	CHROME	TR 91/AC	TP 98/C	TP 99/C	557	1	12
14812703CB	DN 15 1/2	WHITE-CHROME	TR 91/AC	TP 98/C	TP 99/C	561	1	12
14812703B	DN 15 1/2	WHITE	TR 91/AC	TP 98/C	TP 99/C	561	1	12
14812703N	DN 15 1/2	BLACK	TR 91/AC	TP 98/C	TP 99/C	561	1	12

Kit con raccordi inclusi.

CODICE	MISURA	FINITURA			
14010002	DN 15 1/2	CHROME	503	1	12
14010002CB	DN 15 1/2	WHITE-CHROME	507	1	12

CODICE	MISURA	FINITURA			
14010002B	DN 15 1/2	WHITE	507	1	12

CODICE	MISURA	FINITURA			
14010002N	DN 15 1/2	BLACK	507	1	12

	Raccordo	Codice	Misura
2x	TR 91/AC	67761200C	12 mm
2x	TR 91/AC	67761400C	14 mm
2x	TP 99/C	67861612C	16x2

2x	TR 91/AC	67761200B	12 mm
2x	TR 91/AC	67761400B	14 mm
2x	TP 99/C	67861612B	16x2

2x	TR 91/AC	67761200N	12 mm
2x	TR 91/AC	67761400N	14 mm
2x	TP 99/C	67861612N	16x2

CHROME

WHITE-CHROME
 ARTICOLO IN ESAURIMENTO

WHITE

BLACK
KT 2073/A

Kit termostatico coassiale sinistra completo per collegamento ai termoarredi. Composto da: RCS 2073/A + DCD 29/A. Attacco tipo eurocono.

CODICE	MISURA	FINITURA						
14832703	DN 15 1/2	CHROME	TR 91/AC	TP 98/C	TP 99/C	557	1	12
14832703CB	DN 15 1/2	WHITE-CHROME	TR 91/AC	TP 98/C	TP 99/C	561	1	12
14832703B	DN 15 1/2	WHITE	TR 91/AC	TP 98/C	TP 99/C	561	1	12
14832703N	DN 15 1/2	BLACK	TR 91/AC	TP 98/C	TP 99/C	561	1	12

Kit con raccordi inclusi.

CODICE	MISURA	FINITURA			
14010003	DN 15 1/2	CHROME	503	1	12
14010003CB	DN 15 1/2	WHITE-CHROME	507	1	12

CODICE	MISURA	FINITURA			
14010003B	DN 15 1/2	WHITE	507	1	12

CODICE	MISURA	FINITURA			
14010003N	DN 15 1/2	BLACK	507	1	12

	Raccordo	Codice	Misura
2x	TR 91/AC	67761200C	12 mm
2x	TR 91/AC	67761400C	14 mm
2x	TP 99/C	67861612C	16x2
2x	TR 91/AC	67761200B	12 mm
2x	TR 91/AC	67761400B	14 mm
2x	TP 99/C	67861612B	16x2
2x	TR 91/AC	67761200N	12 mm
2x	TR 91/AC	67761400N	14 mm
2x	TP 99/C	67861612N	16x2

KIT MANUALI: ATTACCO TUBO RAME E TUBO PLASTICA G3/4 EUROCONO

CHROME

WHITE-CHROME
 ARTICOLO IN ESAURIMENTO

WHITE

BLACK
KT 59/A

Kit manuale squadra completo per collegamento ai termoarredi. Composto da: RS 59/A + DS 79/A. Attacco tipo eurocono.

CODICE	MISURA	FINITURA						
14622703	DN 15 1/2	CHROME	TR 91/AC	TP 98/C	TP 99/C	502	1	12
14622703CB	DN 15 1/2	WHITE-CHROME	TR 91/AC	TP 98/C	TP 99/C	507	1	12
14622703B	DN 15 1/2	WHITE	TR 91/AC	TP 98/C	TP 99/C	507	1	12
14622703N	DN 15 1/2	BLACK	TR 91/AC	TP 98/C	TP 99/C	561	1	12

Kit con raccordi inclusi.

CODICE	MISURA	FINITURA			
14010004	DN 15 1/2	CHROME	503	1	12
14010004CB	DN 15 1/2	WHITE-CHROME	507	1	12

CODICE	MISURA	FINITURA			
14010004B	DN 15 1/2	WHITE	507	1	12

CODICE	MISURA	FINITURA			
14010004N	DN 15 1/2	BLACK	507	1	12

	Raccordo	Codice	Misura
2x	TR 91/AC	67761200C	12 mm
2x	TR 91/AC	67761400C	14 mm
2x	TP 99/C	67861612C	16x2
2x	TR 91/AC	67761200B	12 mm
2x	TR 91/AC	67761400B	14 mm
2x	TP 99/C	67861612B	16x2
2x	TR 91/AC	67761200N	12 mm
2x	TR 91/AC	67761400N	14 mm
2x	TP 99/C	67861612N	16x2



Raccordi per tubo rame



Raccordi per tubo plastica



Raccordi per tubo multistrato



Raccordi: capitolo 7



Accessori: capitolo 1.A



CHROME

WHITE-CHROME
ARTICOLO IN ESAURIMENTO

KT 69/A

Kit manuale coassiale destra completo per collegamento ai termoarredi. Composto da: RCD 69/A + DCS 33/A. Attacco tipo eurocono.



WHITE



BLACK

CODICE	MISURA	FINITURA						
14692703	DN 15 1/2	CHROME	TR 91/AC	TP 98/C	TP 99/C	561	1	12
14692703CB	DN 15 1/2	WHITE-CHROME	TR 91/AC	TP 98/C	TP 99/C	564	1	12
14692703B	DN 15 1/2	WHITE	TR 91/AC	TP 98/C	TP 99/C	564	1	12
14692703N	DN 15 1/2	BLACK	TR 91/AC	TP 98/C	TP 99/C	564	1	12

Kit con raccordi inclusi.

CODICE	MISURA	FINITURA			
14010005	DN 15 1/2	CHROME	503	1	12
14010005CB	DN 15 1/2	WHITE-CHROME	507	1	12

CODICE	MISURA	FINITURA			
14010005B	DN 15 1/2	WHITE	507	1	12

CODICE	MISURA	FINITURA			
14010005N	DN 15 1/2	BLACK	507	1	12

	Raccordo	Codice	Misura
2x	TR 91/AC	67761200C	12 mm
2x	TR 91/AC	67761400C	14 mm
2x	TP 99/C	67861612C	16x2
2x	TR 91/AC	67761200B	12 mm
2x	TR 91/AC	67761400B	14 mm
2x	TP 99/C	67861612B	16x2
2x	TR 91/AC	67761200N	12 mm
2x	TR 91/AC	67761400N	14 mm
2x	TP 99/C	67861612N	16x2



CHROME

WHITE-CHROME
ARTICOLO IN ESAURIMENTO

KT 73/A

Kit manuale coassiale sinistra completo per collegamento ai termoarredi. Composto da: RCS 73/A + DCD 29/A. Attacco tipo eurocono.



WHITE



BLACK

CODICE	MISURA	FINITURA						
14712703	DN 15 1/2	CHROME	TR 91/AC	TP 98/C	TP 99/C	561	1	12
14712703CB	DN 15 1/2	WHITE-CHROME	TR 91/AC	TP 98/C	TP 99/C	564	1	12
14712703B	DN 15 1/2	WHITE	TR 91/AC	TP 98/C	TP 99/C	564	1	12
14712703N	DN 15 1/2	BLACK	TR 91/AC	TP 98/C	TP 99/C	564	1	12

Kit con raccordi inclusi.

CODICE	MISURA	FINITURA			
14010006	DN 15 1/2	CHROME	503	1	12
14010006CB	DN 15 1/2	WHITE-CHROME	507	1	12

CODICE	MISURA	FINITURA			
14010006B	DN 15 1/2	WHITE	507	1	12

CODICE	MISURA	FINITURA			
14010006N	DN 15 1/2	BLACK	507	1	12

	Raccordo	Codice	Misura
2x	TR 91/AC	67761200C	12 mm
2x	TR 91/AC	67761400C	14 mm
2x	TP 99/C	67861612C	16x2
2x	TR 91/AC	67761200B	12 mm
2x	TR 91/AC	67761400B	14 mm
2x	TP 99/C	67861612B	16x2
2x	TR 91/AC	67761200N	12 mm
2x	TR 91/AC	67761400N	14 mm
2x	TP 99/C	67861612N	16x2



CHROME

WHITE-CHROME
ARTICOLO IN ESAURIMENTO

WHITE

KT 58/A

Kit manuale diretto completo per collegamento ai termoarredi.
Composto da: RD 58/A + DD 78/A.
Attacco tipo eurocono.

CODICE	MISURA	FINITURA						
14822703	DN 15 1/2	CHROME	TR 91/AC	TP 98/C	TP 99/C	566	1	12
14822703CB	DN 15 1/2	WHITE-CHROME	TR 91/AC	TP 98/C	TP 99/C	570	1	12
14822703B	DN 15 1/2	WHITE	TR 91/AC	TP 98/C	TP 99/C	570	1	12

VALVOLE TERMOSTATIZZABILI CON PREREGOLAZIONE: ATTACCO TUBO RAME E TUBO PLASTICA G3/4 EUROCONO

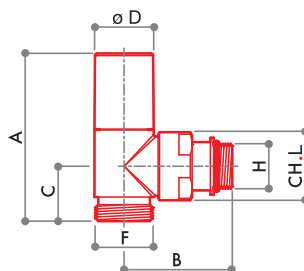

CHROME

WHITE-CHROME
ARTICOLO IN ESAURIMENTO**RS 259/A**

Valvola radiatore a squadra termostattizzabile o elettrocomandabile con cappuccio di protezione. Attacco tipo eurocono.

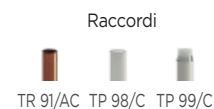

CODICE	MISURA	FINITURA	A	B	C	D	E	F	G	H	L			
14202703	DN 15 1/2	CHROME	67	50	25	37	-	G 3/4EK	-	G 1/2	28	264	5	60
14202703CB	DN 15 1/2	WHITE-CHROME	67	50	25	37	-	G 3/4EK	-	G 1/2	28	265	5	60

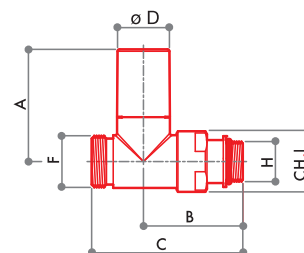

CHROME

WHITE-CHROME
ARTICOLO IN ESAURIMENTO**RD 258/A**

Valvola radiatore diretta termostattizzabile o elettrocomandabile con cappuccio di protezione. Attacco tipo eurocono.



CODICE	MISURA	FINITURA	A	B	C	D	E	F	G	H	L			
14402703	DN 15 1/2	CHROME	48	51	78	37	-	G 3/4EK	-	G 1/2	28	292	5	60
14402703CB	DN 15 1/2	WHITE-CHROME	48	51	78	37	-	G 3/4EK	-	G 1/2	28	293	5	60



CHROME



WHITE-CHROME
ARTICOLO IN ESAURIMENTO

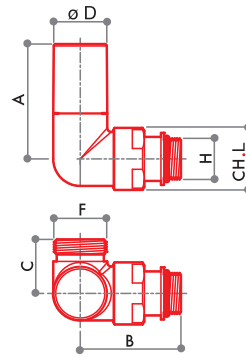

RCD 269/A

Valvola radiatore coassiale destra termostattabile o elettrocomandabile con cappuccio di protezione. Attacco tipo eurocono.

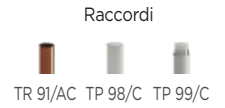

CODICE	MISURA	FINITURA	A	B	C	D	E	F	G	H	L			
14272703	DN 15 1/2	CHROME	48	51	27	37	-	G3/4EK	-	G1/2	28	287	5	60
14272703CB	DN 15 1/2	WHITE-CHROME	48	51	27	37	-	G3/4EK	-	G1/2	28	289	5	60



CHROME



WHITE-CHROME
ARTICOLO IN ESAURIMENTO

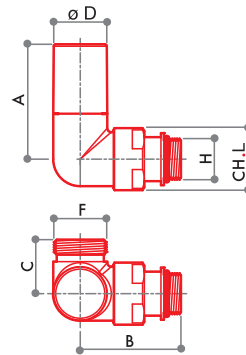

RCS 273/A

Valvola radiatore coassiale sinistra termostattabile o elettrocomandabile con cappuccio di protezione. Attacco tipo eurocono.



CODICE	MISURA	FINITURA	A	B	C	D	E	F	G	H	L			
14292703	DN 15 1/2	CHROME	48	51	27	37	-	G3/4EK	-	G1/2	28	287	5	60
14292703CB	DN 15 1/2	WHITE-CHROME	48	51	27	37	-	G3/4EK	-	G1/2	28	289	5	60



CHROME



WHITE-CHROME
ARTICOLO IN ESAURIMENTO



WHITE



BLACK

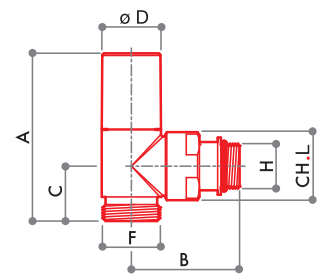

RS 2059/A

Valvola radiatore a squadra termostattabile o elettrocomandabile con volantino di comando manuale. Attacco tipo eurocono.



CODICE	MISURA	FINITURA	A	B	C	D	E	F	G	H	L			
14242703	DN 15 1/2	CHROME	83	50	25	35	-	G 3/4EK	-	G 1/2	28	278	5	60
14242703CB	DN 15 1/2	WHITE-CHROME	83	50	25	35	-	G 3/4EK	-	G 1/2	28	278	5	60
14242703B	DN 15 1/2	WHITE	83	50	25	35	-	G 3/4EK	-	G 1/2	28	278	5	60
14242703N	DN 15 1/2	BLACK	83	50	25	35	-	G 3/4EK	-	G 1/2	28	278	5	60



CHROME



WHITE-CHROME
ARTICOLO IN ESAURIMENTO



WHITE



BLACK

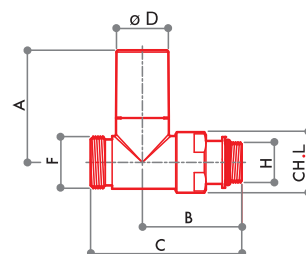

RD 2058/A

Valvola radiatore diritta termostattizzabile o elettrocomandabile con volantino di comando manuale. Attacco tipo eurocono.

Raccordi



CODICE	MISURA	FINITURA	A	B	C	D	E	F	G	H	L			
14442703	DN 15 1/2	CHROME	64	51	78	35	-	G 3/4EK	-	G 1/2	28	305	5	60
14442703CB	DN 15 1/2	WHITE-CHROME	64	51	78	35	-	G 3/4EK	-	G 1/2	28	306	5	60
14442703B	DN 15 1/2	WHITE	64	51	78	35	-	G 3/4EK	-	G 1/2	28	306	5	60
14442703N	DN 15 1/2	BLACK	64	51	78	35	-	G 3/4EK	-	G 1/2	28	306	5	60



CHROME



WHITE-CHROME
ARTICOLO IN ESAURIMENTO



WHITE



BLACK

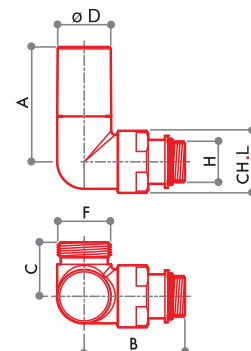

RCD 2069/A

Valvola radiatore coassiale destra termostattizzabile o elettrocomandabile con volantino di comando manuale. Attacco tipo eurocono.

Raccordi



CODICE	MISURA	FINITURA	A	B	C	D	E	F	G	H	L			
14312703	DN 15 1/2	CHROME	64	51	27	35	-	G3/4EK	-	G1/2	28	300	5	60
14312703CB	DN 15 1/2	WHITE-CHROME	64	51	27	35	-	G3/4EK	-	G1/2	28	303	5	60
14312703B	DN 15 1/2	WHITE	64	51	27	35	-	G3/4EK	-	G1/2	28	303	5	60
14312703N	DN 15 1/2	BLACK	64	51	27	35	-	G3/4EK	-	G1/2	28	303	5	60



CHROME



WHITE-CHROME
ARTICOLO IN ESAURIMENTO



WHITE



BLACK

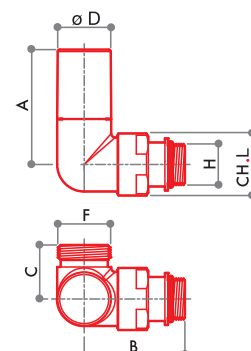

RCS 2073/A

Valvola radiatore coassiale sinistra termostattizzabile o elettrocomandabile con volantino di comando manuale. Attacco tipo eurocono.

Raccordi



CODICE	MISURA	FINITURA	A	B	C	D	E	F	G	H	L			
14332703	DN 15 1/2	CHROME	64	51	27	35	-	G3/4EK	-	G1/2	28	300	5	60
14332703CB	DN 15 1/2	WHITE-CHROME	64	51	27	35	-	G3/4EK	-	G1/2	28	303	5	60
14332703B	DN 15 1/2	WHITE	64	51	27	35	-	G3/4EK	-	G1/2	28	303	5	60
14332703N	DN 15 1/2	BLACK	64	51	27	35	-	G3/4EK	-	G1/2	28	303	5	60



Raccordi per tubo rame



Raccordi per tubo plastica



Raccordi per tubo multistrato



Raccordi: capitolo 7



Accessori: capitolo 1.A

VALVOLE MANUALI: ATTACCO TUBO RAME E TUBO PLASTICA G3/4 EUROCONO



CHROME



WHITE-CHROME
ARTICOLO IN ESAURIMENTO



WHITE



BLACK

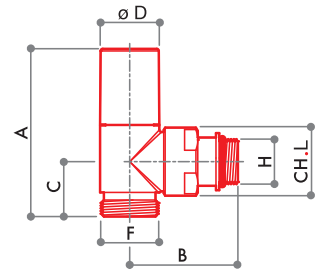

RS 59/A

Valvola radiatore a squadra a semplice regolazione. Attacco tipo eurocono.

Raccordi

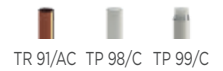

CODICE	MISURA	FINITURA	A	B	C	D	E	F	G	H	L			
14122703	DN 15 1/2	CHROME	77	50	25	27	-	G 3/4EK	-	G 1/2	28	278	5	60
14122703CB	DN 15 1/2	WHITE-CHROME	77	50	25	27	-	G 3/4EK	-	G 1/2	28	278	5	60
14122703B	DN 15 1/2	WHITE	77	50	25	27	-	G 3/4EK	-	G 1/2	28	278	5	60
14122703N	DN 15 1/2	BLACK	77	50	25	27	-	G 3/4EK	-	G 1/2	28	278	5	60



CHROME



WHITE-CHROME
ARTICOLO IN ESAURIMENTO



WHITE



BLACK

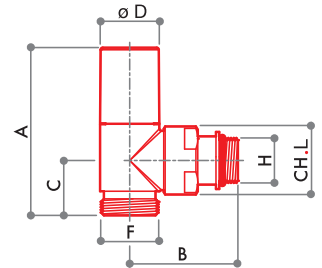

DS 79/A

Detentore di regolazione a squadra. Attacco tipo eurocono.

Raccordi



CODICE	MISURA	FINITURA	A	B	C	D	E	F	G	H	L			
14162703	DN 15 1/2	CHROME	62	50	25	27	-	G 3/4EK	-	G 1/2	28	224	5	60
14162703CB	DN 15 1/2	WHITE-CHROME	62	50	25	27	-	G 3/4EK	-	G 1/2	28	229	5	60
14162703B	DN 15 1/2	WHITE	62	50	25	27	-	G 3/4EK	-	G 1/2	28	229	5	60
14162703N	DN 15 1/2	BLACK	62	50	25	27	-	G 3/4EK	-	G 1/2	28	229	5	60



CHROME



WHITE-CHROME
ARTICOLO IN ESAURIMENTO



WHITE

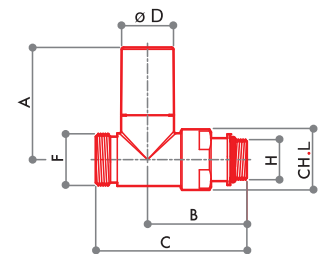

RD 58/A

Valvola radiatore diretta a semplice regolazione. Attacco tipo eurocono.

Raccordi



CODICE	MISURA	FINITURA	A	B	C	D	E	F	G	H	L			
14322703	DN 15 1/2	CHROME	58	51	78	27	-	G 3/4EK	-	G 1/2	28	305	5	60
14322703CB	DN 15 1/2	WHITE-CHROME	58	51	78	27	-	G 3/4EK	-	G 1/2	28	309	5	60
14322703B	DN 15 1/2	WHITE	58	51	78	27	-	G 3/4EK	-	G 1/2	28	309	5	60



CHROME



WHITE-CHROME
ARTICOLO IN ESAURIMENTO



WHITE



BLACK

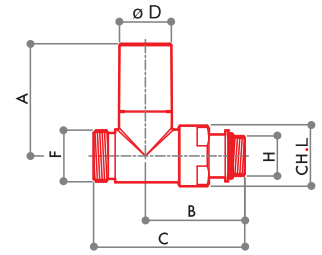

DD 78/A

Detentore di regolazione dritto.
Attacco tipo eurocono.

Raccordi



CODICE	MISURA	FINITURA	A	B	C	D	E	F	G	H	L	🔗	📦	📦
14362703	DN 15 1/2	CHROME	42	51	78	27	-	G 3/4EK	-	G 1/2	28	260	5	60
14362703CB	DN 15 1/2	WHITE-CHROME	42	51	78	27	-	G 3/4EK	-	G 1/2	28	567	5	60
14362703B	DN 15 1/2	WHITE	42	51	78	27	-	G 3/4EK	-	G 1/2	28	567	5	60
14362703N	DN 15 1/2	BLACK	42	51	78	27	-	G 3/4EK	-	G 1/2	28	567	5	60



CHROME



WHITE-CHROME
ARTICOLO IN ESAURIMENTO



WHITE



BLACK

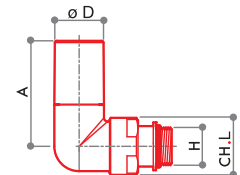

RCD 69/A

Valvola radiatore coassiale destra a semplice regolazione. Attacco tipo eurocono.

Raccordi



CODICE	MISURA	FINITURA	A	B	C	D	E	F	G	H	L	🔗	📦	📦
14192703	DN 15 1/2	CHROME	58	51	27	27	-	G3/4EK	-	G1/2	28	304	5	60
14192703CB	DN 15 1/2	WHITE-CHROME	58	51	27	27	-	G3/4EK	-	G1/2	28	306	5	60
14192703B	DN 15 1/2	WHITE	58	51	27	27	-	G3/4EK	-	G1/2	28	306	5	60
14192703N	DN 15 1/2	BLACK	58	51	27	27	-	G3/4EK	-	G1/2	28	306	5	60



CHROME



WHITE-CHROME
ARTICOLO IN ESAURIMENTO



WHITE



BLACK

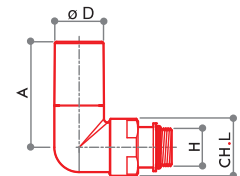

DCS 33/A

Detentore di regolazione coassiale sinistro. Attacco tipo eurocono.

Raccordi



CODICE	MISURA	FINITURA	A	B	C	D	E	F	G	H	L	🔗	📦	📦
14252703	DN 15 1/2	CHROME	42	51	27	27	-	G3/4EK	-	G1/2	28	258	5	60
14252703CB	DN 15 1/2	WHITE-CHROME	42	51	27	27	-	G3/4EK	-	G1/2	28	258	5	60
14252703B	DN 15 1/2	WHITE	42	51	27	27	-	G3/4EK	-	G1/2	28	258	5	60
14252703N	DN 15 1/2	BLACK	42	51	27	27	-	G3/4EK	-	G1/2	28	258	5	60



Raccordi per tubo rame



Raccordi per tubo plastica



Raccordi per tubo multistrato



Raccordi: capitolo 7



Accessori: capitolo 1.A



CHROME



WHITE-CHROME
ARTICOLO IN ESAURIMENTO



WHITE



BLACK

RCS 73/A

Valvola radiatore coassiale sinistra a semplice regolazione. Attacco tipo eurocono.

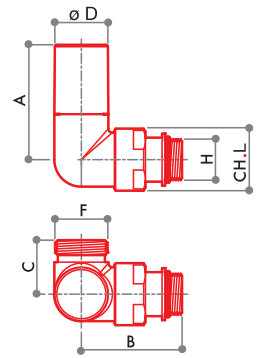

Raccordi



CODICE	MISURA	FINITURA	A	B	C	D	E	F	G	H	L	⊙	⊠	⊞
14212703	DN 15 1/2	CHROME	58	51	27	27	-	G3/4EK	-	G1/2	28	304	5	60
14212703CB	DN 15 1/2	WHITE-CHROME	58	51	27	27	-	G3/4EK	-	G1/2	28	306	5	60
14212703B	DN 15 1/2	WHITE	58	51	27	27	-	G3/4EK	-	G1/2	28	306	5	60
14212703N	DN 15 1/2	BLACK	58	51	27	27	-	G3/4EK	-	G1/2	28	306	5	60



CHROME



WHITE-CHROME
ARTICOLO IN ESAURIMENTO



WHITE



BLACK

DCD 29/A

Detentore di regolazione coassiale destro. Attacco tipo eurocono.

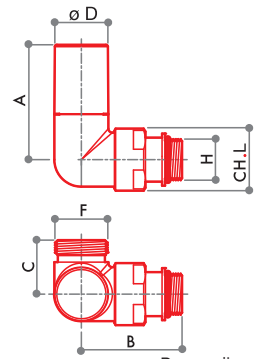

Raccordi



CODICE	MISURA	FINITURA	A	B	C	D	E	F	G	H	L	⊙	⊠	⊞
14232703	DN 15 1/2	CHROME	42	51	27	27	-	G3/4EK	-	G1/2	28	258	5	60
14232703CB	DN 15 1/2	WHITE-CHROME	42	51	27	27	-	G3/4EK	-	G1/2	28	258	5	60
14232703B	DN 15 1/2	WHITE	42	51	27	27	-	G3/4EK	-	G1/2	28	258	5	60
14232703N	DN 15 1/2	BLACK	42	51	27	27	-	G3/4EK	-	G1/2	28	258	5	60

VALVOLE MONOTUBO BITUBO



CHROME



WHITE



BLACK

MT 2590/A

Valvola mono-bitubo termostattizzabile con volantino di comando manuale. Bypass regolabile. Attacco tipo eurocono.

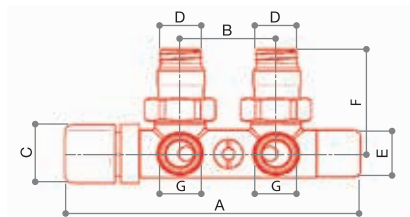

Raccordi



CODICE	MISURA	FINITURA	A	B	C	D	E	F	G	⊙	⊠	⊞
14002703	DN 15 1/2	CHROME	153	50	34	G1/2	26	52	G3/4EK	657	1	10
14002703B	DN 15 1/2	WHITE	153	50	34	G1/2	26	52	G3/4EK	657	1	10
14002703N	DN 15 1/2	BLACK	153	50	34	G1/2	26	52	G3/4EK	657	1	10



TT 3000C

TESTA TERMOSTATICA



CARATTERISTICHE TECNICHE



Max temperatura
120 °C



Max pressione
10 bar



Max pressione
differenziale
0,6 bar

**Temperatura min. di regolazione
(pos. antigelo)**

Ts min 6 °C

**Temperatura max di regolazione
(pos. max)**

Ts max 30 °C (5)

Condizioni di risparmio

20 °C

**Campo di inalterabilità dell'elemento
termostatico**

-15 °C ÷ 60 °C

Temperatura di stoccaggio

-20 °C ÷ + 50 °C

Isteresi

C 0,4 k

Influenza della pressione

D 0,5 k

Influenza della temperatura dell'acqua

W 0,25 k

Tempo di risposta

Z 22 min.

Control Accuracy

CA 0,2 K.

ATTACCO VALVOLA



M 30 x 1,5

**PER MAGGIORI INFORMAZIONI
FARE RIFERIMENTO AL CAPITOLO
THERMOTEKNA**

CARATTERISTICHE COSTRUTTIVE

Le teste termostatiche sono costituite da un sensore riempito con un elemento ad alta espansibilità.

L'elemento, che si trova all'interno della manopola di regolazione o nel sensore a distanza, è in grado di dilatarsi o ridursi proporzionalmente all'aumento o alla diminuzione di temperatura ambiente, registrando anche minime variazioni.

Quando la temperatura circostante aumenta, l'elemento si espande e, attraverso il movimento assiale di spinta, influenza la posizione dell'otturatore, controllando così l'azione della valvola.

Con la chiusura e l'apertura della valvola è possibile regolare il flusso del fluido termovettore.

TESTA TERMOSTATICA CON COMANDO E SENSORE INCORPORATO



CHROME



WHITE-CHROME



BLACK

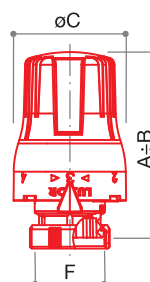

TT 3000

Testa termostatica con comando e sensore incorporato.

CODICE	MISURA	FINITURA	A	B	C	D	E	F	G	H	L			
69100000C	M30x1,5	CHROME	75	80	46,5	-	-	M30x1,5	-	-	-	110	1	100
69100000CB	M30x1,5	WHITE-CHROME	75	80	46,5	-	-	M30x1,5	-	-	-	110	1	100
69100000N	M30x1,5	BLACK	75	80	46,5	-	-	M30x1,5	-	-	-	110	1	100

DIAGRAMMA DI PORTATA VALVOLE

VALVOLE MANUALI

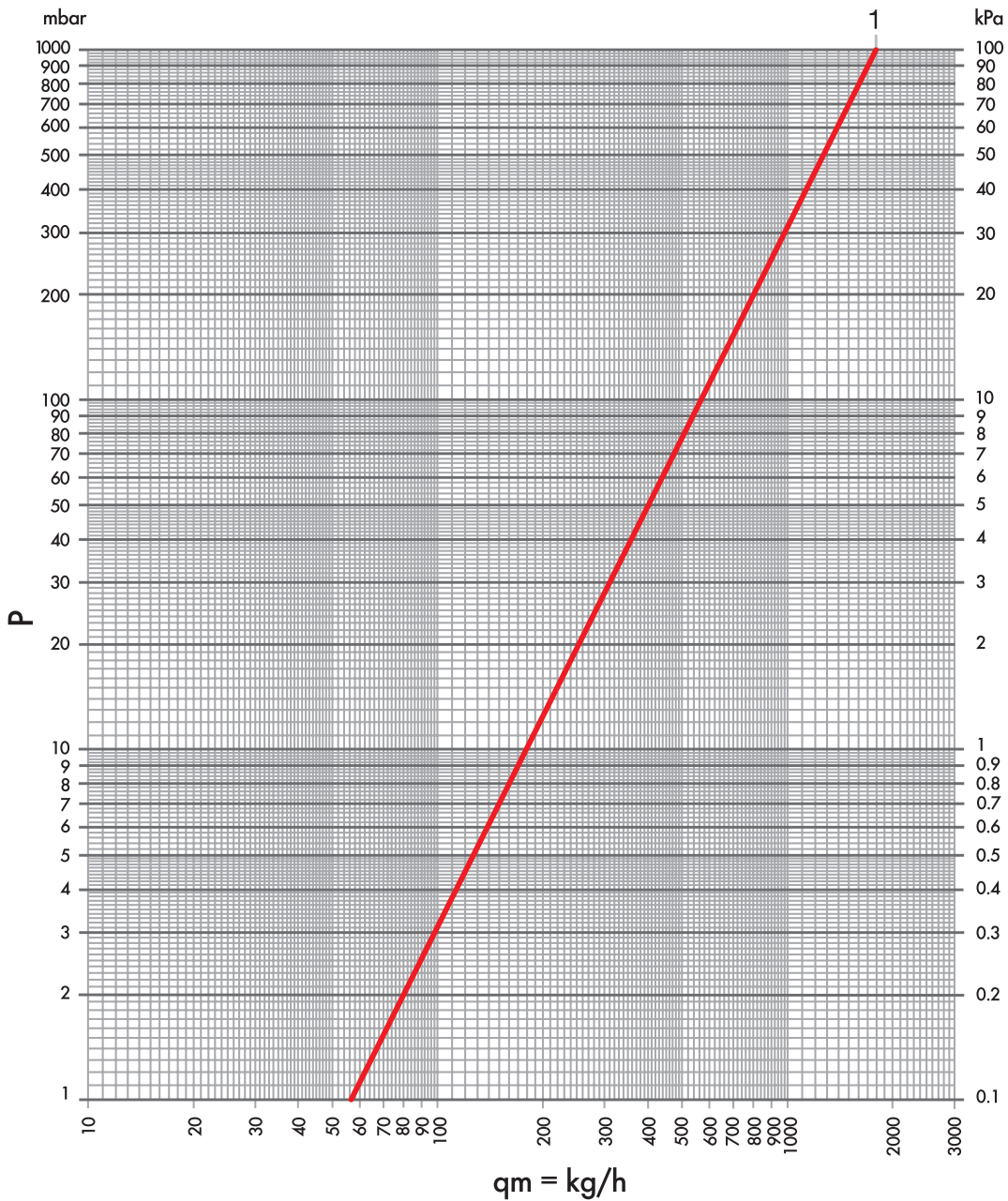

ARTICOLI	N. GIRI	Kv	POS
RD 58/A 1/2 RS 59/A 1/2 RCD 69/A 1/2 RCS 73/A 1/2	1	1,85	1

DIAGRAMMA DI PORTATA VALVOLE

VALVOLE THERMO

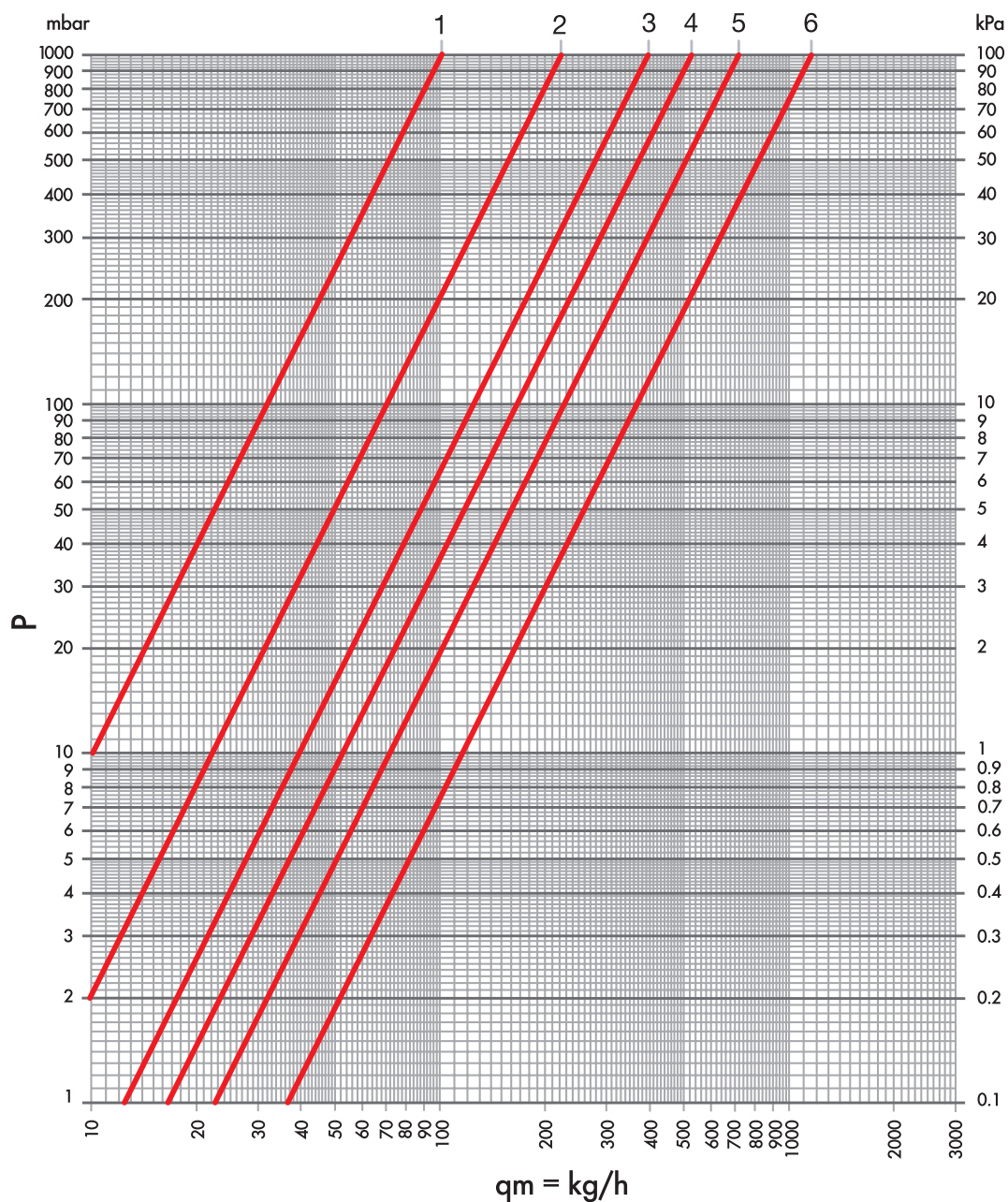

ARTICOLI	Kv	Kv Δt 1 °C	Kv Δt 2 °C	POS
	0,10	0,11	0,15	1
RD 258/A RS 259/A	0,22	0,16	0,25	2
RCD 269/A RCS 273/A	0,39	0,18	0,36	3
RD 2058/A RS 2059/A	0,52	0,18	0,37	4
RCD 2069/A RCS 2073/A	0,71	0,19	0,43	5
	1,25	0,20	0,50	6

DIAGRAMMA DI PORTATA DETENTORE

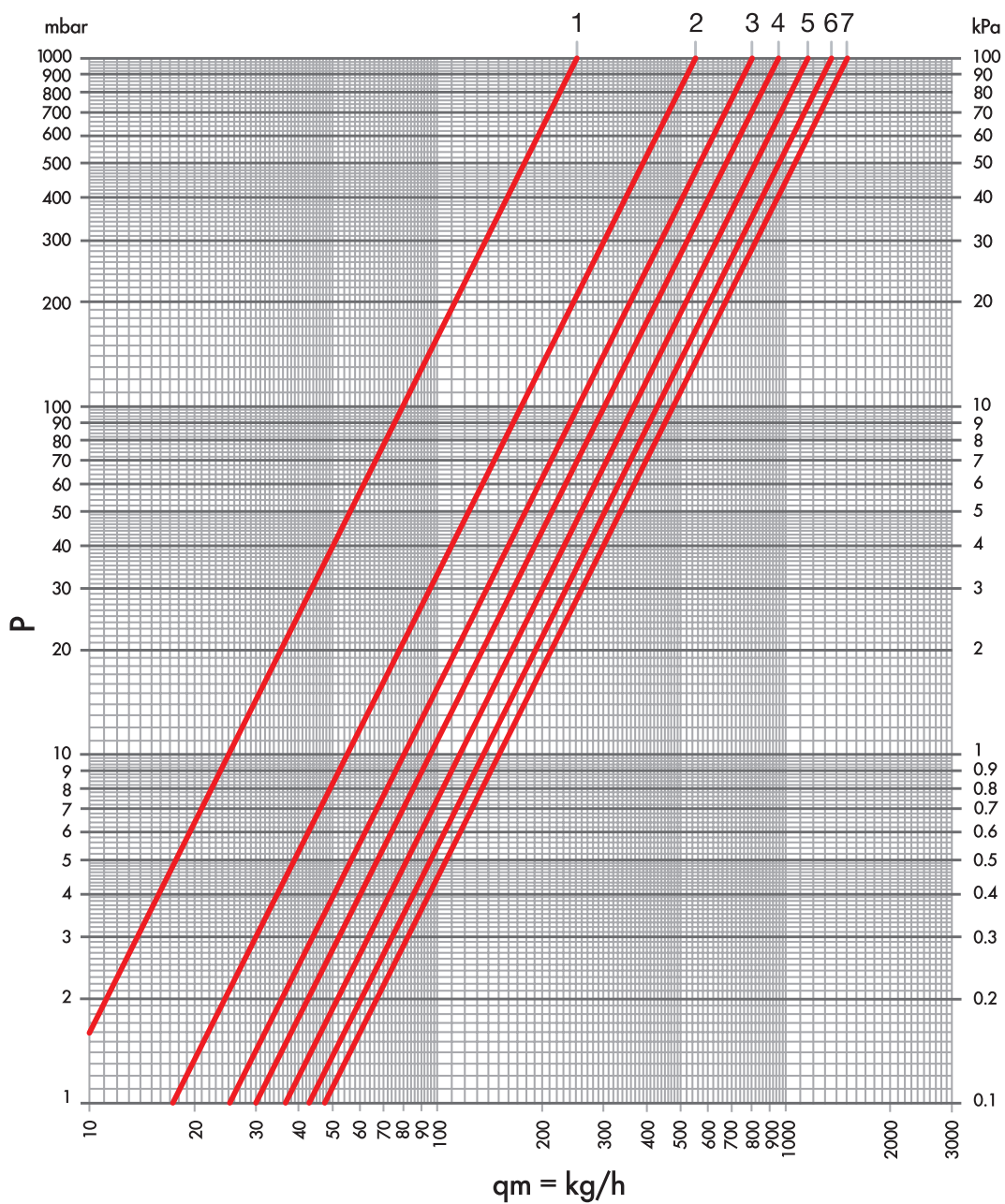

ARTICOLI	N. GIRI	Kv	POS
DD 78/A DS 79/A DCD 29/A DCS 33/A	1	0,25	1
	1+1/2	0,55	2
	2	0,80	3
	2+1/2	0,95	4
	3	1,15	5
	3+1/2	1,35	6
	tutto aperto	1,50	7



LUXOR®

VALVOLE RADIATORE

1.5 / M-MT

M

VALVOLE MANUALI A 4 VIE PER IMPIANTI MONOTUBO



Le valvole monotubo utilizzano un'asta fissa la cui tenuta è garantita da un o-ring e da una guarnizione piana in teflon regolabile da una ghiera premistoppa in ottone. Le valvole sono prodotte con finitura nichelata.

CARATTERISTICHE TECNICHE



DN

15
20

Max temperatura

120 °C



Max pressione

10 bar

Max pressione
differenziale

1 bar



Materiale

CW617N
UNI EN
12165:2016

Manopola

ABS bianco
RAL 9016

Sonda

Poliammide

ATTACCHI IMPIANTO

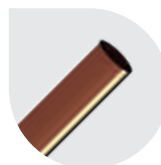
**Tubo rame**

W 24x19 - TR 91

**Tubo plastica**

W 24x19 - TP 95

**Tubo multistrato**

W 24x19 - TP 97

COLLEGAMENTO RADIATORE

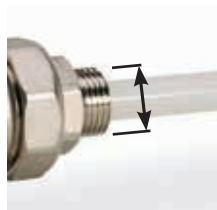
**filetto
cilindrico**
G 1/2
G 3/4

INTERASSI



40 mm

SONDA

Le valvole a 4 vie serie M sono dotate di una sonda articolo M 523 in poliammide che permette loro di distribuire correttamente il flusso in corpi scaldanti lunghi fino a 50 cm. Nel caso non sia rispettata la freccia stampata sul corpo indicante la direzione del flusso, oppure in presenza di installazioni

con corpi scaldanti più lunghi di 50 cm, è necessario applicare la prolunga in poliammide articolo M 525 e deve essere tagliata in modo che l'altra estremità sia posta a 10 cm dalla fine del corpo scaldante.



Le caratteristiche del fluido dell'impianto devono essere conformi alla direttiva UNI 8065:2019.

VALVOLE MANUALI A 4 VIE PER IMPIANTI MONOTUBO M 87

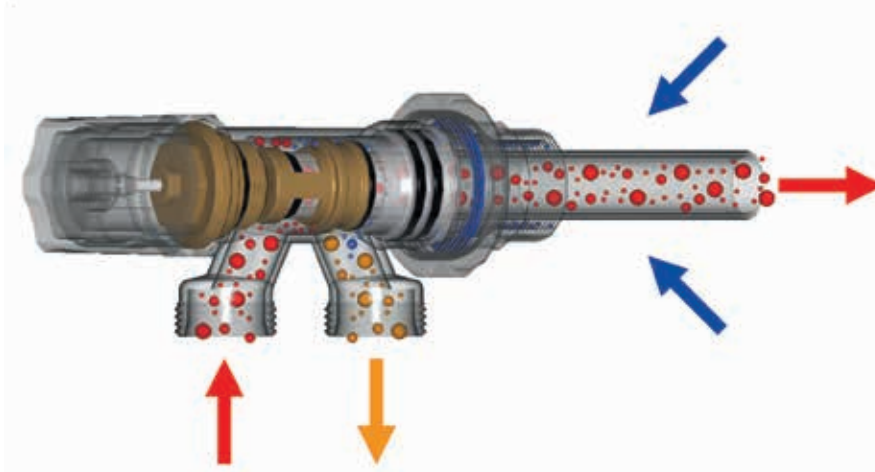

Luxor produce valvole manuali a 4 vie per impianti monotubo e bitubo in grado di soddisfare tutte le esigenze impiantistiche.

Tutte le valvole a 4 vie adottano una soluzione costruttiva che permette di avere l'ingresso e l'uscita del flusso da un unico attacco al corpo scaldante. Queste valvole devono essere installate sull'attacco inferiore del corpo scaldante.

Le valvole a 4 vie per impianti monotubo hanno lo scopo di:

- allacciare il corpo scaldante alle tubazioni dell'anello monotubo, che può essere in rame, plastica o tubo multistrato PEX-AL-PEX;
- permettere la regolazione della temperatura nell'ambiente, variando il flusso in ingresso nel corpo scaldante;

- intercettare il flusso in modo da permettere la manutenzione al corpo scaldante senza compromettere il funzionamento degli altri corpi scaldanti.

Il flusso in arrivo alla valvola è diviso in due parti: una parte entra nel corpo scaldante, l'altra attraverso il bypass prosegue verso il corpo scaldante successivo. Il vantaggio è che il flusso uscito dal corpo scaldante a bassa temperatura si miscela con il flusso che è passato attraverso il bypass a più alta temperatura, in questo modo il flusso che proseguirà verso il corpo scaldante successivo avrà una potenza termica superiore.

La valvola M 87 ha il bypass fisso, in posizione di massima apertura il 50% della portata dell'anello entra nel corpo scaldante.

VALVOLE MANUALI A 4 VIE PER IMPIANTI MONOTUBO E BITUBO M 88

La valvola M 88 in posizione di massima apertura non ha il bypass e il 100% della portata dell'anello entra nel corpo scaldante (vedi immagine).

Il bypass si apre progressivamente in proporzione alla chiusura dell'otturatore (vedi sotto).

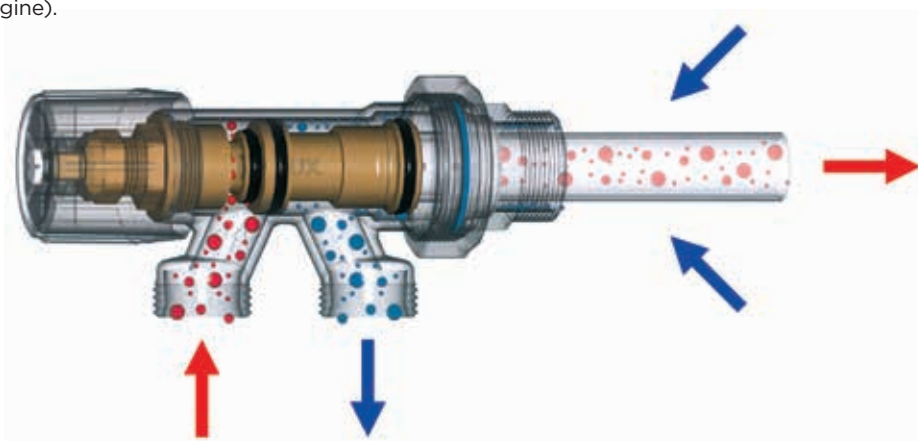

La valvola M 88 in posizione di chiusura ha il bypass al 100% della portata dell'anello, dunque non entra liquido nel corpo scaldante.

Le altre caratteristiche sono uguali alle valvole manuali M 87 per impianti monotubo.

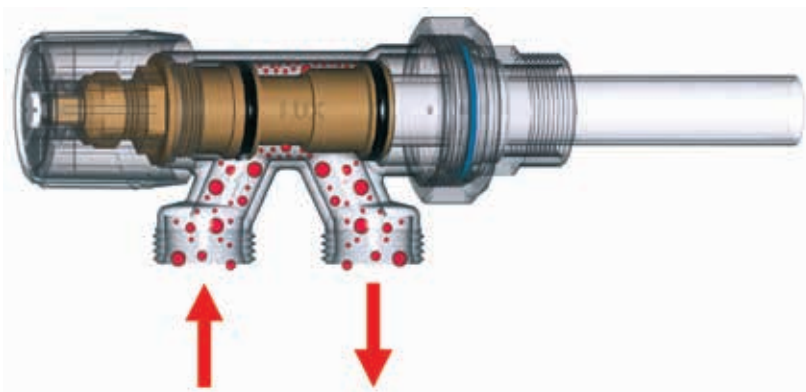

VALVOLE MANUALI VERTICALI A 4 VIE PER IMPIANTI MONOTUBO M 81-83-85

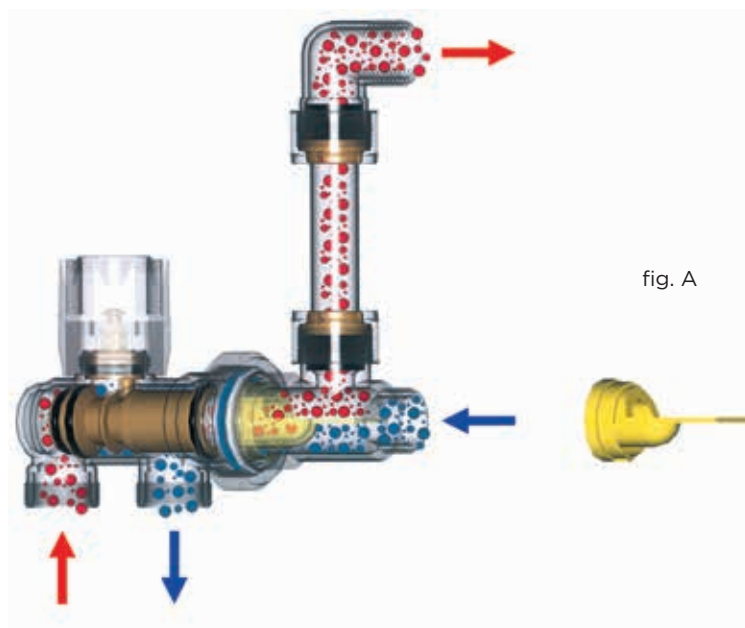

Le valvole manuali verticali a 4 vie possono essere monotubo con un bypass al 50% della portata oppure bitubo al 100% della portata dell'anello. Le valvole devono essere collegate alla rete rispettando le frecce posizionate sul corpo. In questo modo le valvole sono in grado di riscaldare un corpo scaldante fino a 7-8 elementi. Nel caso non sia rispettato il verso del flusso o il corpo scaldante sia di dimensioni maggiori agli 8 elementi, nella valvola M 81 e M 83 deve essere installata la prolunga articolo M 525.

La prolunga deve essere tagliata in modo che l'altra estremità sia posta a 10 cm dalla fine del corpo scaldante. Nelle valvole M 85 e M 86 se non viene rispettato il verso del flusso bisogna girare il setto nel corpo del convogliatore in modo tale da far riprendere il giusto verso del flusso. Utilizzando il setto come in figura A il flusso deve entrare dall'attacco come raffigurato dalla freccia.

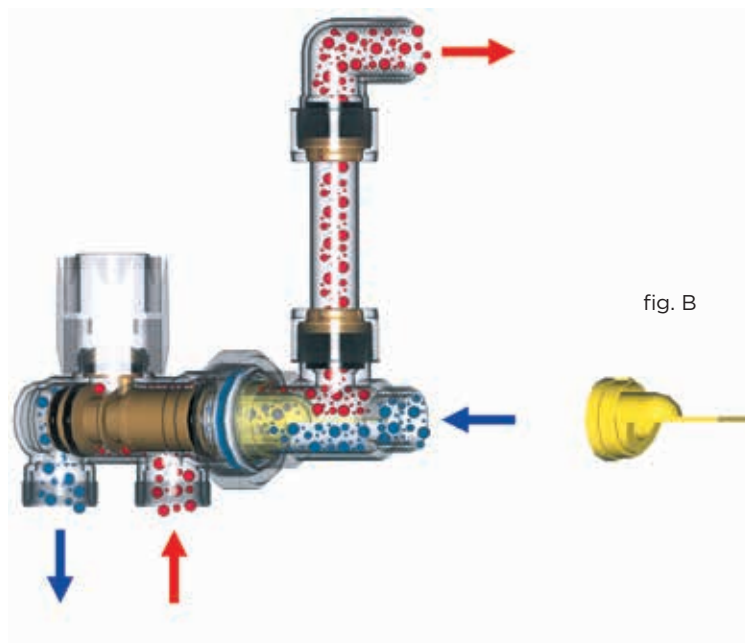

Se in fase di installazione non dovesse essere rispettato il senso della freccia utilizzare il setto come in figura B.

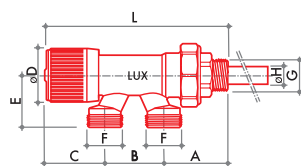
**VALVOLE MANUALI A 4 VIE PER IMPIANTI MONOTUBO:
ATTACCO TUBO RAME E TUBO PLASTICA W24x19**
**M 87**

Valvola monotubo a semplice regolazione, manuale orizzontale. Portata massima al corpo scaldante: 50% della portata dell'anello. Attacchi tubo rame e tubo plastica.

Raccordi

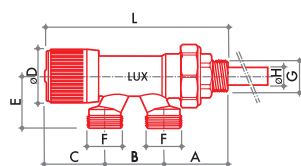

CODICE	MISURA	A	B	C	D	E	F	G	H	L			
68072100	DN 15 1/2	45	40	41	37	35	W24x19	G 1/2	12	126	360	5	40
68072700	DN 20 3/4	45	40	41	37	35	W24x19	G 3/4	16	126	358	5	40

**M 88**

Valvola monotubo a semplice regolazione, manuale orizzontale (per impianti bitubo). Portata massima al corpo scaldante: 100% della portata dell'anello. Attacchi tubo rame e tubo plastica.

Raccordi

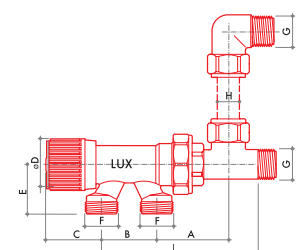

CODICE	MISURA	A	B	C	D	E	F	G	H	L			
68072101	DN 15 1/2	45	40	41	37	35	W24x19	G 1/2	12	126	366	5	40
68072701	DN 20 3/4	45	40	41	37	35	W24x19	G 3/4	16	126	363	5	40

**M 86**

Valvola monotubo diritta a semplice regolazione orizzontale, con convogliatore di flusso. Portata massima al corpo scaldante: 50% e 100% della portata dell'anello. Attacchi tubo rame e tubo plastica.

Raccordi

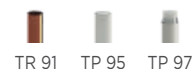

CODICE	MISURA	A	B	C	D	E	F	G	H	L			
68072102	DN 15 1/2 50%	52	40	41	37	35	W24x19	G 1/2	15	110	488	5	40
68072103	DN 15 1/2 100%	52	40	41	37	35	W24x19	G 1/2	15	110	490	5	40

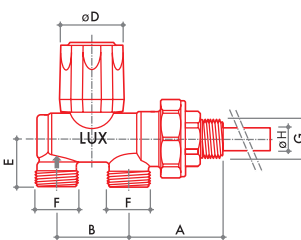
**M 81**

Valvola monotubo a semplice regolazione, manuale verticale. Portata massima al corpo scaldante: 50% della portata dell'anello. Attacchi tubo rame e tubo plastica.

Raccordi



CODICE	MISURA	A	B	C	D	E	F	G	H	L			
68032101	DN 15 1/2	50	40	-	35	27	W24x19	G 1/2	12	-	344	5	40
68032701	DN 20 3/4	50	40	-	35	27	W24x19	G 3/4	16	-	346	5	40



Raccordi per tubo rame



Raccordi per tubo plastica



Raccordi per tubo multistrato



Raccordi: capitolo 7



Accessori: capitolo 1.A

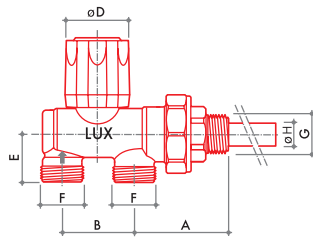

M 83

Valvola monotubo a semplice regolazione, manuale verticale. Portata massima al corpo scaldante: 100% della portata dell'anello. Attacchi tubo rame e tubo plastica.

Raccordi



CODICE	MISURA	A	B	C	D	E	F	G	H	L			
68042100	DN 15 1/2	50	40	-	35	27	W24x19	G 1/2	12	-	346	5	40
68042700	DN 20 3/4	50	40	-	35	27	W24x19	G 3/4	16	-	348	5	40

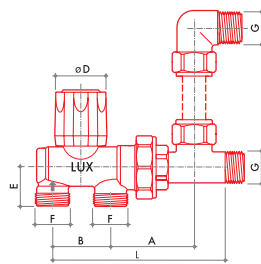

M 85

Valvola monotubo diritta a semplice regolazione, verticale con convogliatore di flusso. Portata massima al corpo scaldante: 50% e 100% della portata dell'anello. Attacchi tubo rame e tubo plastica.

Raccordi



CODICE	MISURA	A	B	C	D	E	F	G	H	L			
68042102	DN 15 1/2 50%	57	40	-	35	27	W24x19	G 1/2	15	114	552	5	40
68042103	DN 15 1/2 100%	57	40	-	35	27	W24x19	G 1/2	15	114	555	5	40

DIAGRAMMA DI PORTATA VALVOLE

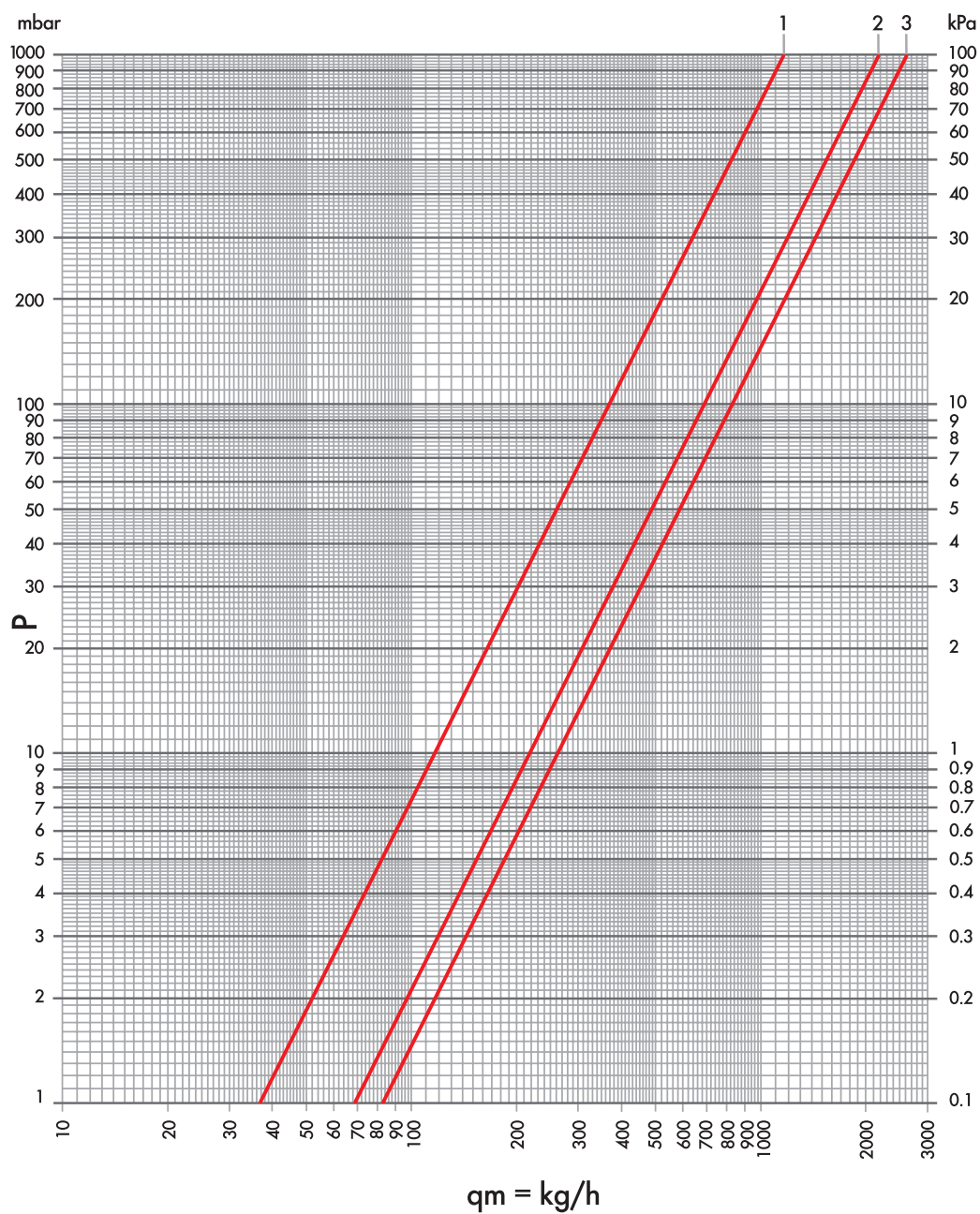

ARTICOLI	Kv	POS
M 88 1/2 M 88 3/4 M 86 1/2 100%	1.61	1
M 83 1/2 M 83 3/4 M 85 1/2 100%	2.16	2
M 87 1/2 M 87 3/4 M 86 1/2 50% M 81 1/2 M 81 3/4 M 85 1/2 50%	2.60	3

MT

VALVOLE TERMOSTATICHE A 4 VIE PER IMPIANTI MONOTUBO



Le valvole monotubo termostattizzabili, se equipaggiate con la testa termostatica e con un $\Delta t=2K$, consentono di alimentare il corpo scaldante con una portata pari al 35% della portata totale del circuito. Il vitone termostatico permette la so-

stituzione di uno degli o-ring di tenuta sull'asta di comando senza che sia necessario svuotare l'impianto. Le valvole sono prodotte con finitura nichelata.

CARATTERISTICHE TECNICHE



DN
15
20



Max temperatura
120 °C



Max pressione
10 bar



Max pressione differenziale
1 bar



Materiale
CW617N
UNI EN
12165:2016



Manopola
ABS bianco
RAL 9016



Asta di comando
AISI 316



Sonda
Poliammide

ATTACCHI IMPIANTO

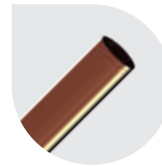

Tubo rame
W 24x19 - TR 91

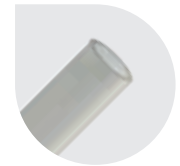

Tubo plastica
W 24x19 - TP 95



Tubo multistrato
W 24x19 - TP 97

COLLEGAMENTO RADIATORE

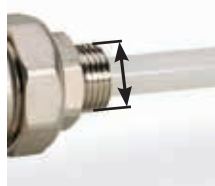

filetto cilindrico
G 1/2
G 3/4

INTERASSI



40 mm

SONDA

Le valvole a 4 vie serie M sono dotate di una sonda articolo M 523 in poliammide che permette loro di distribuire correttamente il flusso in corpi scaldanti lunghi fino a 50 cm. Nel caso non sia rispettata la freccia stampata sul corpo indicante la direzione del flusso, oppure in presenza

di installazioni con corpi scaldanti più lunghi di 50 cm, è necessario applicare la prolunga in poliammide articolo M 525 e deve essere tagliata in modo che l'altra estremità sia posta a 10 cm dalla fine del corpo scaldante.



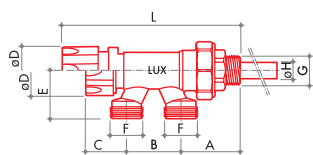

Le caratteristiche del fluido dell'impianto devono essere conformi alla direttiva UNI 8065:2019.

**VALVOLE TERMOSTATICHE A 4 VIE PER IMPIANTI MONOTUBO:
ATTACCO TUBO RAME E TUBO PLASTICA W24x19**
**MT 282**

Valvola monotubo termostattizzabile o elettrocomandabile con cappuccio di protezione. Portata massima al corpo scaldante: 35% della portata dell'anello ($\Delta t=2K$). Attacchi tubo rame e tubo plastica.

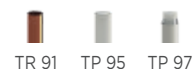
Raccordi





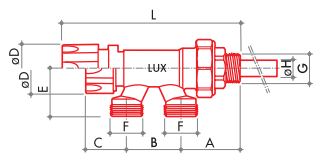

CODICE	MISURA	A	B	C	D	E	F	G	H	L			
68010021	DN 15 1/2	46	40	30	37	35	W24x19	G 1/2	12	115	353	5	40
68010027	DN 20 3/4	46	40	30	37	35	W24x19	G 3/4	16	115	351	5	40

**MT 2582**

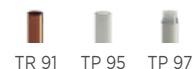
Valvola monotubo termostattizzabile o elettrocomandabile con volantino di comando manuale articolo VT 2600. Portata massima al corpo scaldante: 35% della portata dell'anello ($\Delta t=2K$). Attacchi tubo rame e tubo plastica.

Raccordi



CODICE	MISURA	A	B	C	D	E	F	G	H	L			
68010121	DN 15 1/2	46	40	47	35	35	W24x19	G 1/2	12	133	360	5	40
68010127	DN 20 3/4	46	40	47	35	35	W24x19	G 3/4	16	133	360	5	40



Raccordi per tubo rame



Raccordi per tubo plastica



Raccordi per tubo multistrato



Raccordi: capitolo 7



Accessori: capitolo 1.A

DIAGRAMMA DI PORTATA VALVOLE

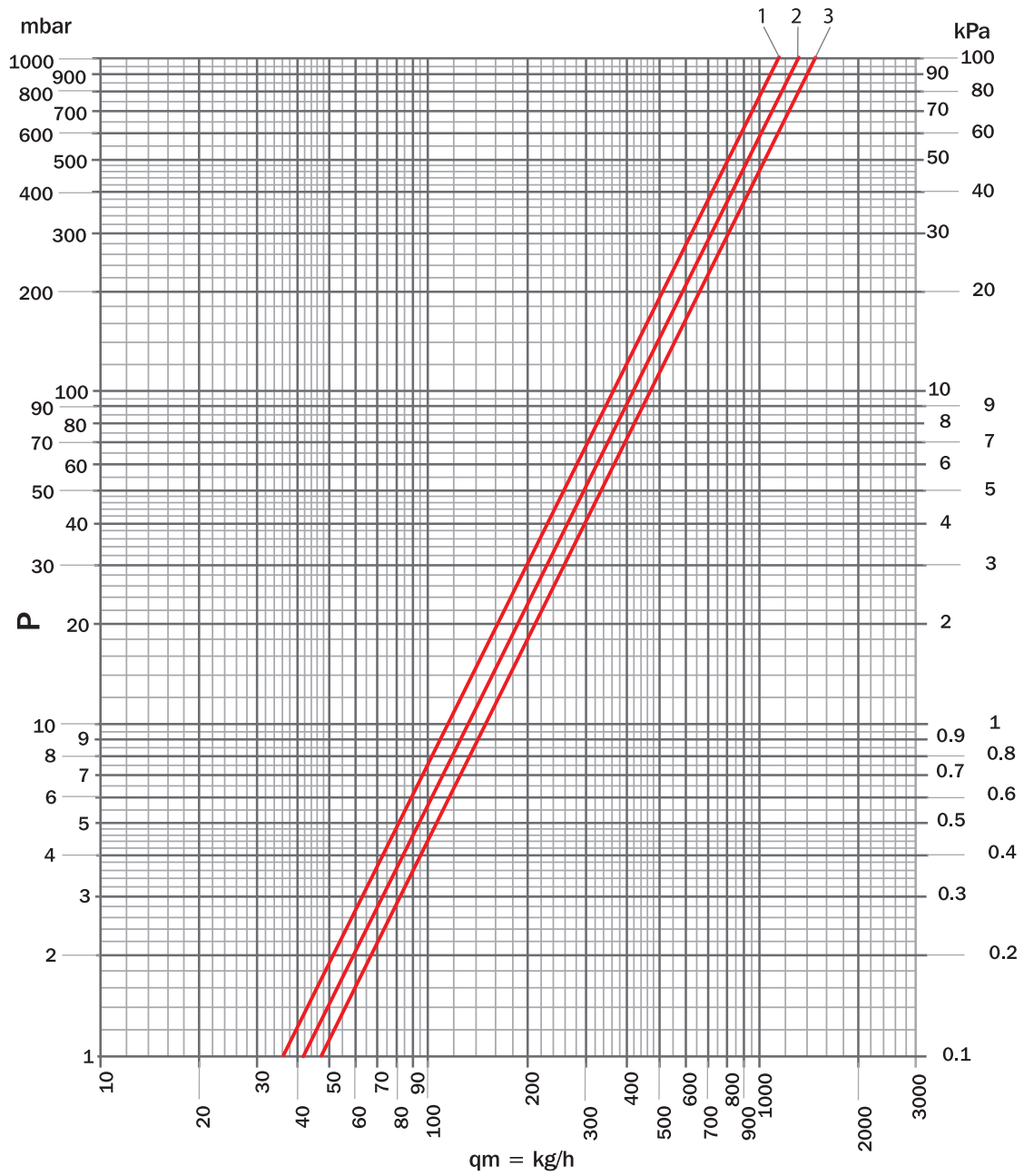

ARTICOLI	MISURA	RA %	N. GIRI	Kv	POS
MT 282	DN 15 1/2	0	chiuso	1,15	1
	DN 20 3/4			1,15	1
	DN 15 1/2	100	tutto aperto	1,30	2
	DN 20 3/4			1,45	3
MT 2582	DN 15 1/2	0	chiuso	1,15	1
	DN 20 3/4			1,15	1
	DN 15 1/2	100	tutto aperto	1,30	2
	DN 20 3/4			1,45	3

M

VALVOLE PER IMPIANTI MONOTUBO E BITUBO



Le valvole manuali serie M utilizzano un'asta fissa la cui tenuta è garantita da un o-ring e da una guarnizione piana in PTFE regolabile da una ghiera premistoppa in ottone. La tenuta in chiusura con l'otturatore è assicurata da un o-ring e da una tenuta conica metallica. Le valvole termostattizzabili

serie M hanno un vitone che offre la possibilità di preregolazione grazie ad un anello in acetalica sagomato. Il vitone termostatico permette la sostituzione di uno degli o-ring di tenuta sull'asta di comando senza che sia necessario svuotare l'impianto. Le valvole sono prodotte con finitura nichelata.

CARATTERISTICHE TECNICHE



DN

15



Max temperatura

120 °C



Max pressione

10 bar



Max pressione differenziale (valvole termostatiche)

0,6 bar



Max pressione differenziale

1 bar



Materiale

CW617N
UNI EN
12165:2016

Manopola

ABS bianco
RAL 9016

Asta di comando

AISI 316



Collaudo

100%

ATTACCHI IMPIANTO



Tubo ferro
G 1/2

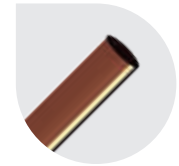

Tubo rame
W 24x19 - TR 91
G 3/4 EK - TR 91/A



Tubo plastica
W 24x19 - TP 95
G 3/4 EK - TP 98



Tubo multistrato
W 24x19 - TP 97
G 3/4 EK - TP 99

COLLEGAMENTO RADIATORE



filetto conico zigrinato
G 1/2

REGOLAZIONE DELLA PORTATA E REVERSE FLOW

Per regolare la massima portata della valvola si deve agire nel seguente modo:

- allineare la tacca di riferimento presente sull'asta in acciaio inox con una delle posizioni stampate sul corpo della valvola.

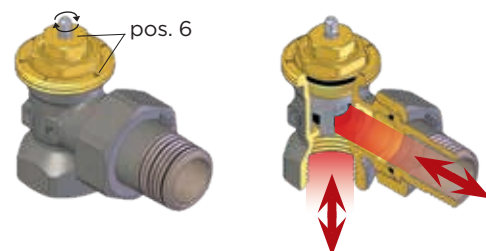
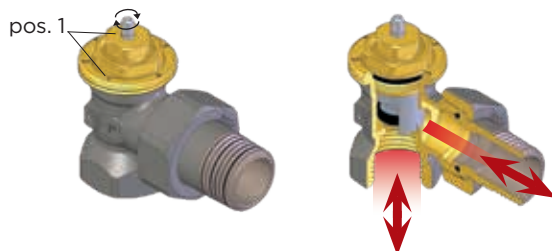

Tutte le valvole e i detentori vengono testati al 100% con prova di tenuta pneumatica a controllo elettronico.

Le caratteristiche del fluido dell'impianto devono essere conformi alla direttiva UNI 8065:2019.

**VALVOLE PER IMPIANTI MONOTUBO E BITUBO:
ATTACCO TUBO RAME E TUBO PLASTICA W24x19**

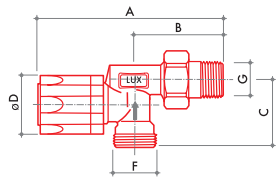

M 300

Valvola radiatore a corpo reverso a semplice regolazione. Attacco tubo rame e tubo plastica.

Raccordi



CODICE	MISURA	A	B	C	D	E	F	G	H	L			
13062100	DN 15 1/2	108	52	39	35	-	W24x19	R 1/2	-	-	215	10	80

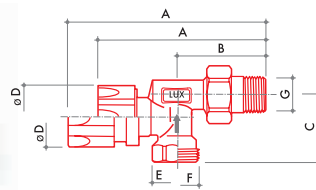

M 320

Valvola radiatore a corpo reverso termostattizzabile o elettrocomandabile con cappuccio di protezione. Attacco tubo rame e tubo plastica.

Raccordi



CODICE	MISURA	A	B	C	D	E	F	G	H	L			
13102100	DN 15 1/2	95	52	39	37	-	W24x19	R 1/2	-	-	207	10	80

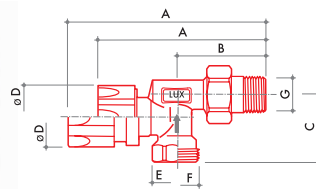

M 330

Valvola radiatore a corpo reverso termostattizzabile o elettrocomandabile con volantino di comando manuale. Attacco tubo rame e tubo plastica.

Raccordi



CODICE	MISURA	A	B	C	D	E	F	G	H	L			
13122100	DN 15 1/2	116	52	39	35	-	W24x19	R 1/2	-	-	215	10	80

VALVOLE PER IMPIANTI MONOTUBO E BITUBO: ATTACCO TUBO RAME E TUBO PLASTICA G3/4 EUROCONO

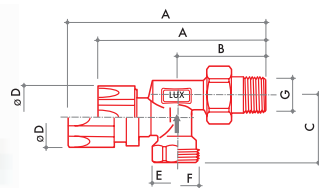

M 320/A

Valvola radiatore a corpo reverso termostattabile o elettrocomandabile con cappuccio di protezione. Attacchi tipo eurocono.

Raccordi



CODICE	MISURA	A	B	C	D	E	F	G	H	L	⚖️	📏	📦
13102721	DN 15 1/2	95	52	39	37	-	G 3/4 EK	R 1/2	-	-	210	10	80

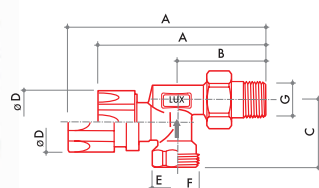

M 330/A

Valvola radiatore a corpo reverso termostattabile o elettrocomandabile con volantino di comando manuale. Attacchi tipo eurocono.

Raccordi



CODICE	MISURA	A	B	C	D	E	F	G	H	L	⚖️	📏	📦
13122721	DN 15 1/2	116	52	39	35	-	G 3/4 EK	R 1/2	-	-	217	10	80

VALVOLE PER IMPIANTI MONOTUBO E BITUBO: ATTACCO TUBO FERRO

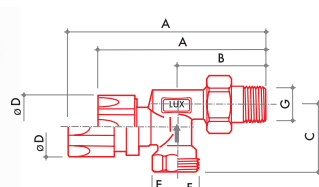

M 322

Valvola radiatore a corpo reverso termostattabile o elettrocomandabile con cappuccio di protezione. Attacchi tubo ferro.

Raccordi



CODICE	MISURA	A	B	C	D	E	F	G	H	L	⚖️	📏	📦
13202100	DN 15 1/2	95	52	40	37	G 1/2	-	R 1/2	-	-	221	10	80

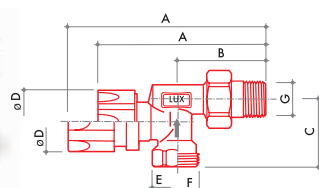

M 332

Valvola radiatore a corpo reverso termostattabile o elettrocomandabile con volantino di comando manuale. Attacchi tubo ferro.

Raccordi



CODICE	MISURA	A	B	C	D	E	F	G	H	L	⚖️	📏	📦
13222100	DN 15 1/2	116	52	40	35	G 1/2	-	R 1/2	-	-	228	10	80



Raccordi per tubo rame



Raccordi per tubo plastica



Raccordi per tubo multistrato



Raccordi: capitolo 7



Accessori: capitolo 1.A

DIAGRAMMA DI PORTATA VALVOLE

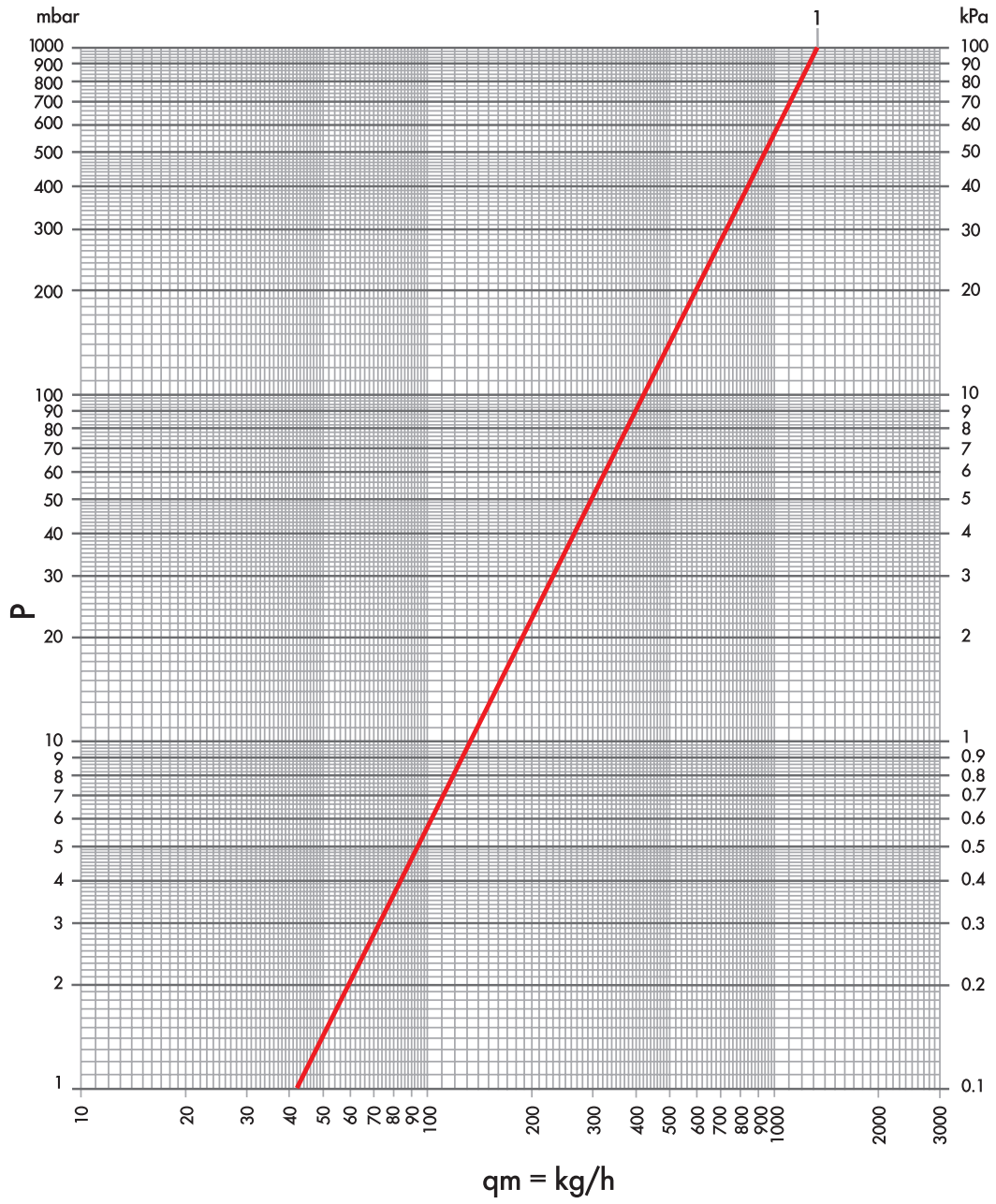

ARTICOLI	Kv	POS
M 300	1.31	1

DIAGRAMMA DI PORTATA VALVOLE

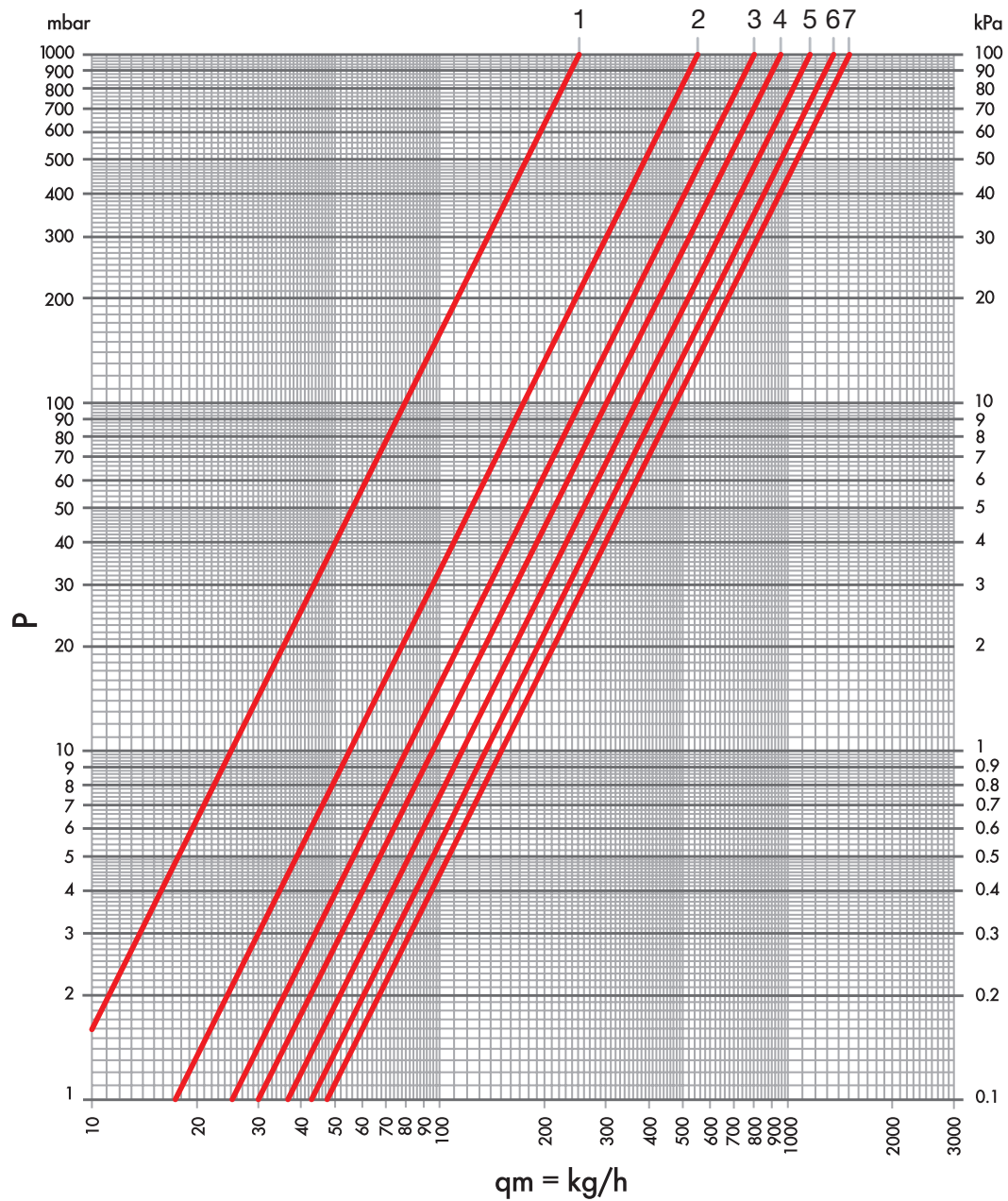

ARTICOLI	N. GIRI	Kv	POS
MD 331/A MS 331/A	1	0,25	1
	1+1/2	0,55	2
	2	0,80	3
	2+1/2	0,95	4
	3	1,15	5
	3+1/2	1,35	6
	tutto aperto	1,50	7

DIAGRAMMA DI PORTATA VALVOLE

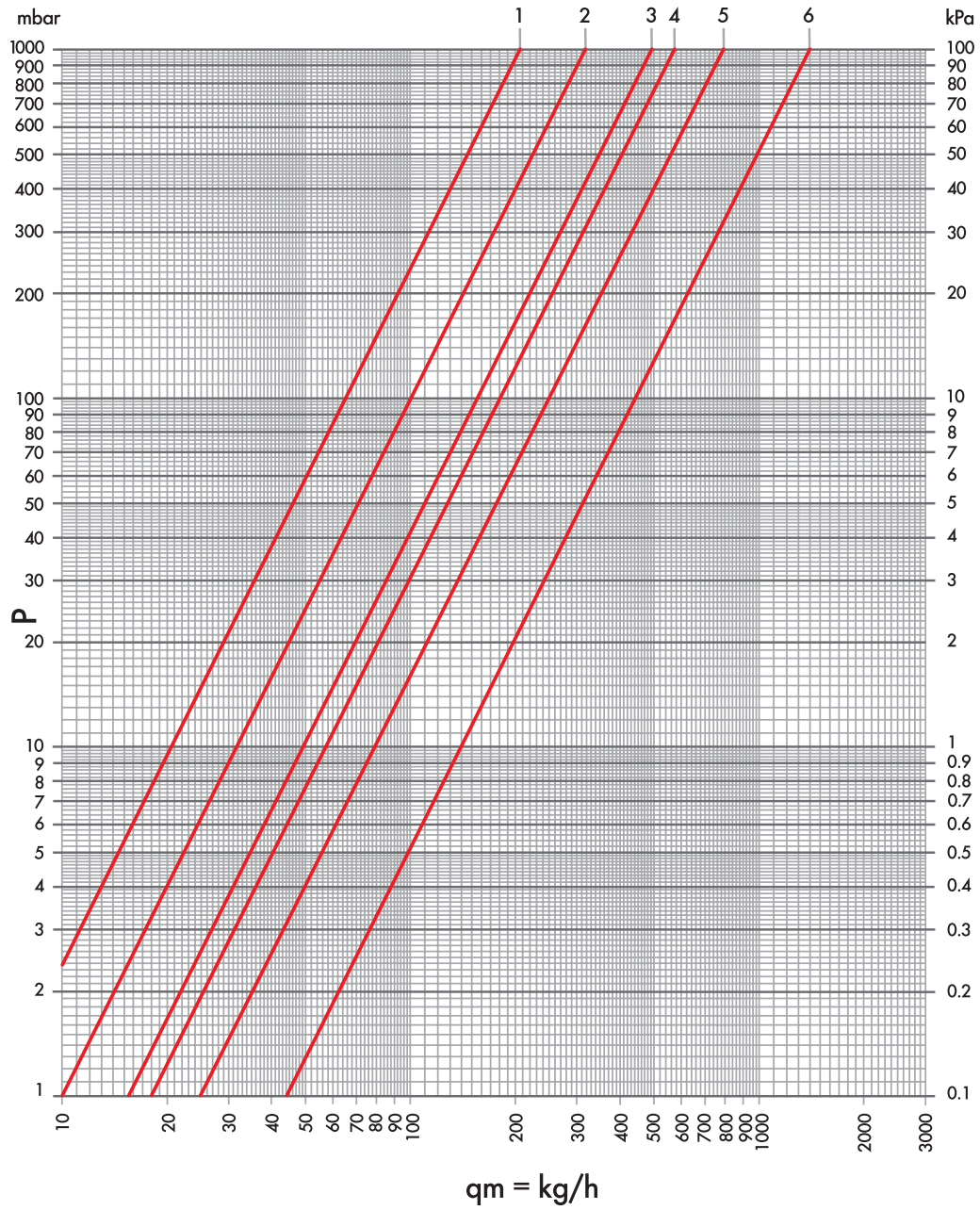

ARTICOLI	Kv	Kv Δt 1 °C	Kv Δt 2 °C	POS
	0.21	0.15	0.19	1
M 320 M 320/A	0.32	0.20	0.25	2
M 330 M 330/A	0.49	0.24	0.36	3
M 322 M 332	0.57	0.24	0.37	4
MD 321/A MS 331/A	0.79	0.24	0.40	5
	1.39	0.32	0.55	6

M

DISTRIBUTORI A 4 VIE PER IMPIANTI MONOTUBO E BITUBO



I distributori hanno la tenuta verso l'esterno assicurata da un o-ring e da una guarnizione piatta all'interno del tappo. La tenuta in chiusura con l'otturatore è assicurata da un o-ring.

I distributori sono prodotti con finitura nichelata. Tutti i distributori hanno la possibilità di regolare la portata limitando l'alzata dell'otturatore.

CARATTERISTICHE TECNICHE



DN

15



Max temperatura

120 °C



Max pressione

10 bar



Max pressione differenziale

1 bar



Materiale

CW617N
UNI EN
12165:2016



Manopola

ABS bianco
RAL 9016

ATTACCHI IMPIANTO

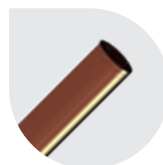
**Tubo rame**

W 24x19 - TR 91

**Tubo plastica**

W 24x19 - TP 95

**Tubo multistrato**

W 24x19 - TP 97

COLLEGAMENTO RADIATORE



filetto conico zigrinato
G 1/2

INTERASSI

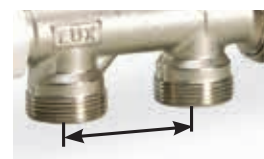

40 mm

INSTALLAZIONE CON VALVOLE A CORPO REVERSO

I distributori serie M devono essere installati rispettando scrupolosamente la freccia stampata sul corpo indicante la direzione del flusso.

I distributori a 4 vie possono avere l'attacco all'impianto dal pavimento o dalla parete.

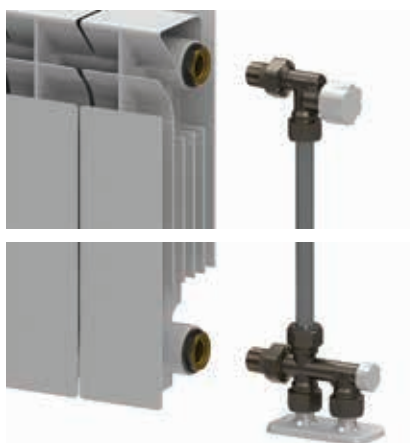

Le caratteristiche del fluido dell'impianto devono essere conformi alla direttiva UNI 8065:2019.

**DISTRIBUTORI A 4 VIE PER IMPIANTI MONOTUBO E BITUBO:
ATTACCO TUBO RAME E TUBO PLASTICA W24X19**

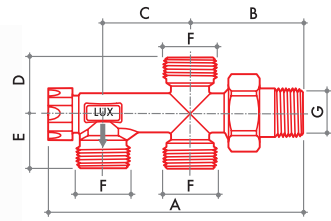

M 341

Distributore a 4 vie con attacchi a pavimento. Portata massima al corpo scaldante: 50% della portata dell'anello. Attacchi tubo rame e tubo plastica.

Raccordi



CODICE	MISURA	A	B	C	D	E	F	G	H	L			
13142100	DN 15 1/2	118	52	40	25	25	W24x19	R 1/2	-	-	243	10	80

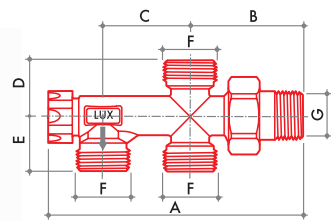

M 351

Distributore a 4 vie con attacchi a pavimento. Portata massima al corpo scaldante: 100% della portata dell'anello. Attacchi tubo rame e tubo plastica.

Raccordi



CODICE	MISURA	A	B	C	D	E	F	G	H	L			
13152100	DN 15 1/2	118	52	40	25	25	W24x19	R 1/2	-	-	244	10	80

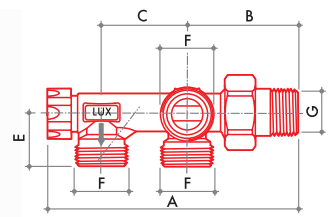

M 361

Distributore a 4 vie con attacchi a parete. Portata massima al corpo scaldante: 50% della portata dell'anello. Attacchi tubo rame e tubo plastica.

Raccordi



CODICE	MISURA	A	B	C	D	E	F	G	H	L			
13242100	DN 15 1/2	118	52	40	-	25	W24x19	R 1/2	-	-	308	6	48

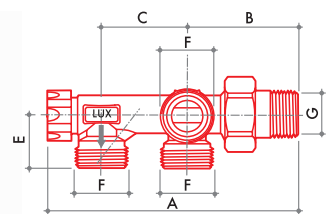

M 371

Distributore a 4 vie con attacchi a parete. Portata massima al corpo scaldante: 100% della portata dell'anello. Attacchi tubo rame e tubo plastica.

Raccordi

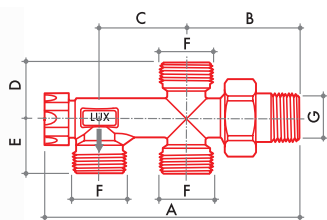

CODICE	MISURA	A	B	C	D	E	F	G	H	L			
13252100	DN 15 1/2	118	52	40	-	25	W24x19	R 1/2	-	-	309	6	48

**DISTRIBUTORI A 4 VIE PER IMPIANTI MONOTUBO E BITUBO:
ATTACCO TUBO RAME E TUBO PLASTICA G3/4 EUROCONO**
**M 341/A**

Distributore a 4 vie con attacchi a pavimento. Portata massima al corpo scaldante: 50% della portata dell'anello. Attacchi tipo eurocono.

Raccordi

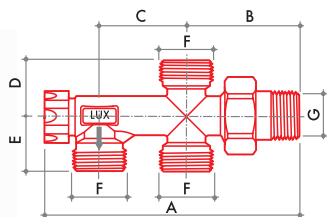

CODICE	MISURA	A	B	C	D	E	F	G	H	L	⚖️	📦	📦
13142721	DN 15 1/2	118	52	40	25	25	G 3/4 EK	R 1/2	-	-	245	10	80

**M 351/A**

Distributore a 4 vie con attacchi a pavimento. Portata massima al corpo scaldante: 100% della portata dell'anello. Attacchi tipo eurocono.

Raccordi

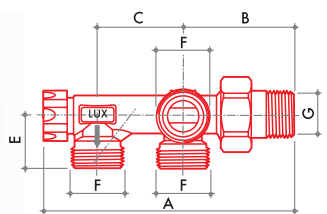

CODICE	MISURA	A	B	C	D	E	F	G	H	L	⚖️	📦	📦
13152721	DN 15 1/2	118	52	40	25	25	G 3/4 EK	R 1/2	-	-	256	10	80

**M 361/A**

Distributore a 4 vie con attacchi a parete. Portata massima al corpo scaldante: 50% della portata dell'anello. Attacchi tipo eurocono.

Raccordi

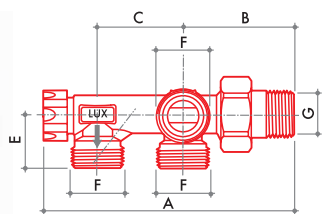

CODICE	MISURA	A	B	C	D	E	F	G	H	L	⚖️	📦	📦
13242721	DN 15 1/2	118	52	40	-	25	G 3/4 EK	R 1/2	-	-	310	6	48

**M 371/A**

Distributore a 4 vie con attacchi a parete. Portata massima al corpo scaldante: 100% della portata dell'anello. Attacchi tipo eurocono.

Raccordi



CODICE	MISURA	A	B	C	D	E	F	G	H	L	⚖️	📦	📦
13252721	DN 15 1/2	118	52	40	-	25	G 3/4 EK	R 1/2	-	-	320	6	48



Raccordi per tubo rame



Raccordi per tubo plastica



Raccordi per tubo multistrato



Raccordi: capitolo 7



Accessori: capitolo 1.A

DIAGRAMMA DI PORTATA DISTRIBUTORI

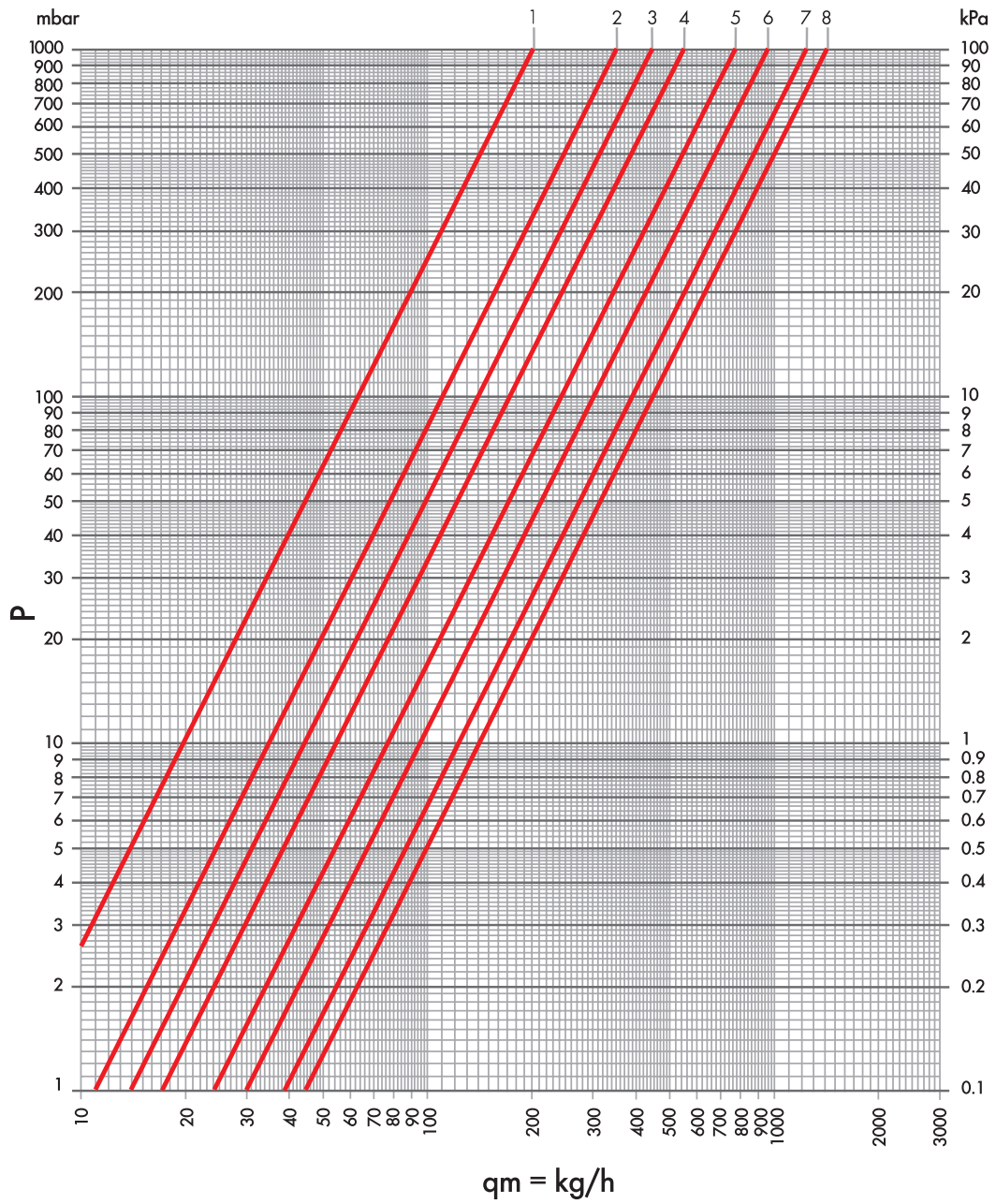

ARTICOLI	N. GIRI	Kv	POS
M 351 M 351/A M 371 M 371/A	1	0.20	1
	1+1/2	0.35	2
	2	0.43	3
	2+1/2	0.55	4
	3	0.78	5
	3+1/2	0.95	6
	4	1.22	7
	tutto aperto	1.41	8

DIAGRAMMA DI PORTATA DISTRIBUTORI

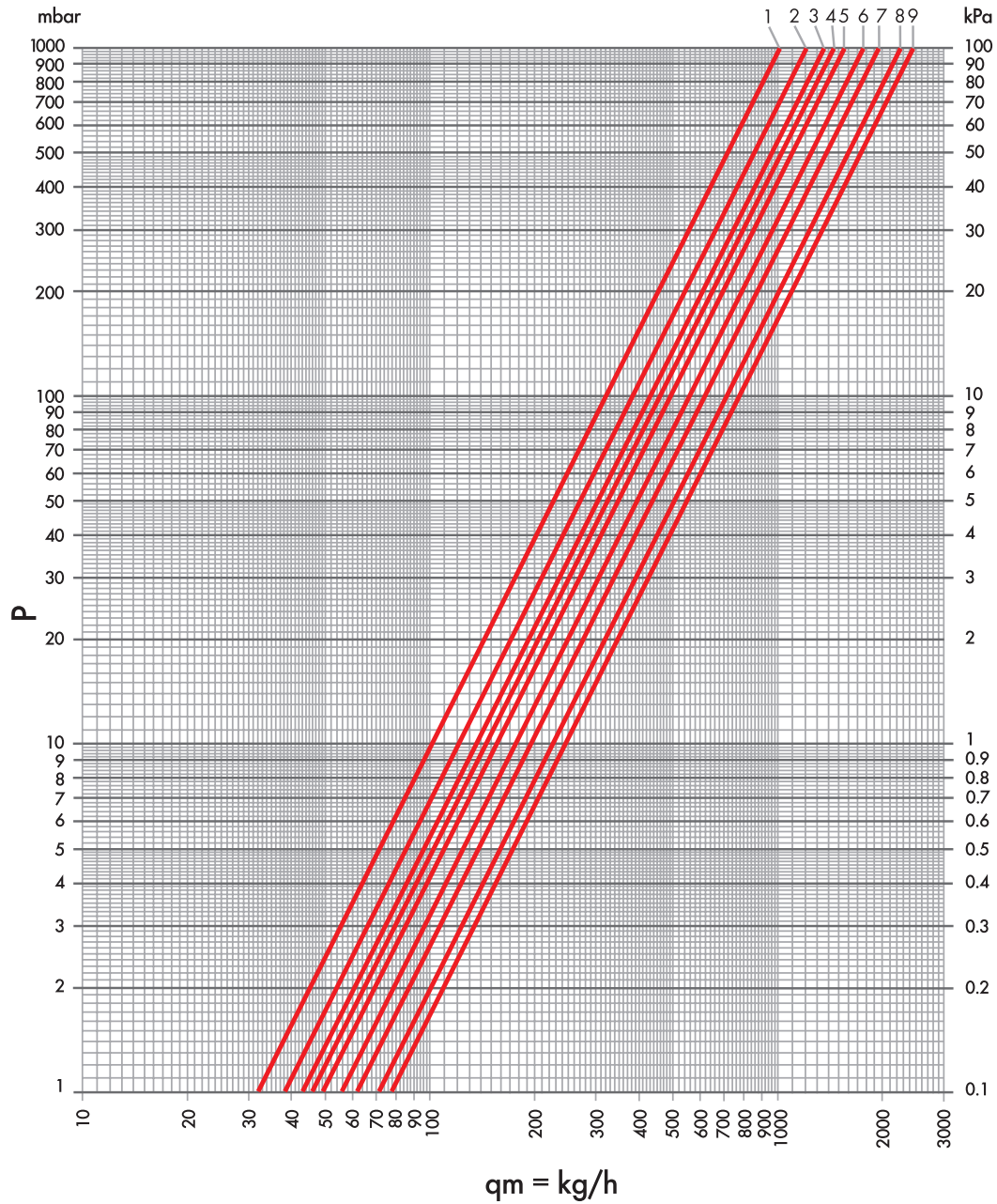

ARTICOLI	N. GIRI	Kv	POS
M 341 M 341/A M 361 M 361/A	chiuso	1.00	1
	1	1.20	2
	1+1/2	1.35	3
	2	1.43	4
	2+1/2	1.55	5
	3	1.78	6
	3+1/2	1.95	7
	4	2.22	8
	tutto aperto	2.41	9

M VALVOLE COASSIALI



Le valvole coassiali hanno un vitone che offre la possibilità di prerogolazione grazie ad un anello in acetalica sagomato. Il vitone termostatico permette la sostituzione di uno degli o-ring di tenuta sull'asta di comando senza che sia necessario svuotare l'impianto. Le valvole sono prodotte con finitura nichelata.

I detentori hanno la tenuta assicurata da un o-ring sull'otturatore e se necessario da un ulteriore o-ring tra il corpo e il tappo. La tenuta in chiusura con l'otturatore è assicurata da un o-ring e da una tenuta conica metallica. I detentori sono prodotti con finitura nichelata. Tutti i detentori hanno la possibilità di regolare la portata limitando l'alzata dell'otturatore.

CARATTERISTICHE TECNICHE



DN

15



Max temperatura

120 °C



Max pressione

10 bar



Max pressione differenziale (valvole termostatiche)

0,6 bar



Max pressione differenziale

1 bar



Materiale

CW617N
UNI EN
12165:2016



Manopola

ABS bianco
RAL 9016



Asta di comando

AISI 316

ATTACCHI IMPIANTO

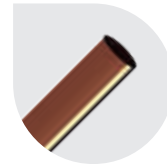

Tubo rame
G 3/4 EK - TR 91/A

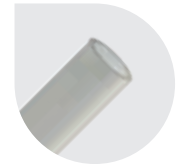

Tubo plastica
G 3/4 EK - TP 98



Tubo multistrato
G 3/4 EK - TP 99

COLLEGAMENTO RADIATORE



**filetto
conico zigrinato**
G 1/2

COME SELEZIONARE LE VALVOLE COASSIALI CORRETTE

KIT TERMOSTATICO COASSIALE DESTRA



Detentore sinistro

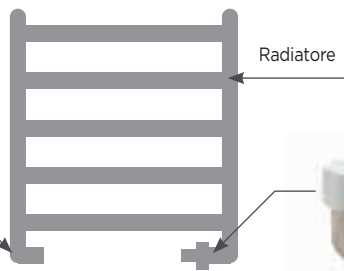

Valvola termostatica
o manuale destra

KIT TERMOSTATICO COASSIALE SINISTRA



Valvola termostatica
o manuale sinistra

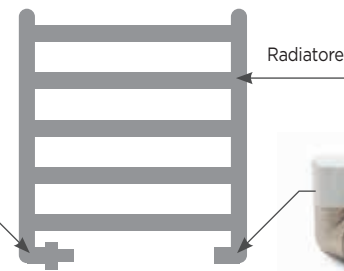

Detentore destro

Le caratteristiche del fluido dell'impianto devono essere conformi alla direttiva UNI 8065:2019.

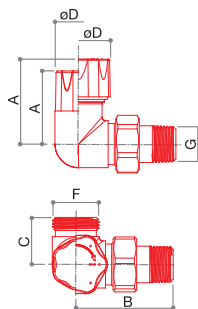

VALVOLE COASSIALI: ATTACCO TUBO RAME E TUBO PLASTICA G3/4 EUROCONO

**MD 321/A**

Valvola radiatore coassiale destra termostattizzabile o elettrocomandabile con cappuccio di protezione. Attacco tipo eurocono.

Raccordi



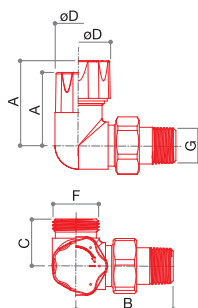

CODICE	MISURA	A	B	C	D	E	F	G	H	L			
13272722	DN 15 1/2	49	56	27	37	-	G 3/4 EK	R 1/2	-	-	287	10	80

**MS 331/A**

Detentore di regolazione coassiale sinistro. Attacchi tipo eurocono.

Raccordi



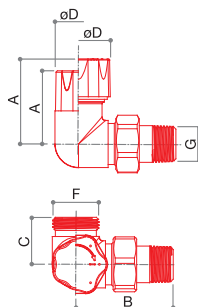

CODICE	MISURA	A	B	C	D	E	F	G	H	L			
13252722	DN 15 1/2	42	56	27	30	-	G 3/4 EK	R 1/2	-	-	258	10	80

**MS 321/A**

Valvola radiatore coassiale sinistra termostattizzabile o elettrocomandabile con cappuccio di protezione. Attacco tipo eurocono.

Raccordi



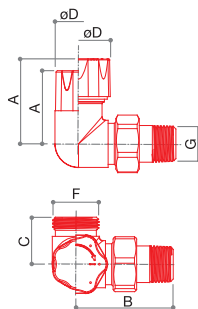

CODICE	MISURA	A	B	C	D	E	F	G	H	L			
13292722	DN 15 1/2	49	56	27	37	-	G 3/4 EK	R 1/2	-	-	287	10	80

**MD 331/A**

Detentore di regolazione coassiale destro. Attacco tipo eurocono.

Raccordi



CODICE	MISURA	A	B	C	D	E	F	G	H	L			
13232722	DN 15 1/2	42	56	27	30	-	G 3/4 EK	R 1/2	-	-	258	10	80



Raccordi per tubo rame



Raccordi per tubo plastica



Raccordi per tubo multistrato



Raccordi: capitolo 7



Accessori: capitolo 1.A

M

DISTRIBUTORI PER IMPIANTI MONOTUBO E BITUBO PER CORPI SCALDANTI CON VALVOLA INCORPORATA



I distributori hanno la tenuta assicurata da un o-ring e da una guarnizione piatta all'interno del tappo. La tenuta in chiusura con l'otturatore è assicurata da un o-ring e da una tenuta conica metallica.

I distributori sono prodotti con finitura nichelata. Tutti i distributori hanno la possibilità di regolare la portata limitando l'alzata dell'otturatore.

CARATTERISTICHE TECNICHE



DN
15



Max temperatura
120 °C



Max pressione
10 bar



Max pressione differenziale
1 bar



Materiale
CW617N
UNI EN
12165:2016



Manopola
ABS bianco
RAL 9016

ATTACCHI IMPIANTO

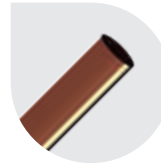

Tubo rame
W 24x19 - TR 91
G 3/4 EK - TR 91/A

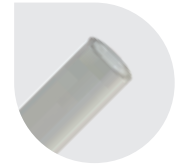

Tubo plastica
W 24x19 - TP 95
G 3/4 EK - TP 98



Tubo multistrato
W 24x19 - TP 97
G 3/4 EK - TP 99

INTERASSI



50 mm

COLLEGAMENTO RADIATORE

I distributori sono progettati per poter essere collegati ai corpi scaldanti con attacchi da G 3/4 eurocono. Nel caso gli attacchi siano da G 1/2 F è possibile utilizzare gli adattatori art. M 532.

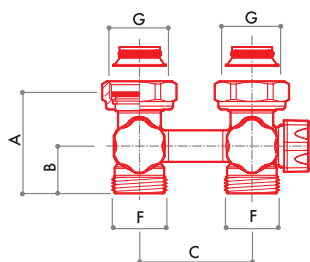

Le caratteristiche del fluido dell'impianto devono essere conformi alla direttiva UNI 8065:2019.

DISTRIBUTORI PER IMPIANTI MONOTUBO E BITUBO PER CORPI SCALDANTI CON VALVOLA INCORPORATA: ATTACCO TUBO RAME E TUBO PLASTICA W24x19
**M 171**

Distributori mono-bitubo

- attacchi al corpo scaldante con dado girevole da 3/4 femmina
- attacchi pavimento 24x19 per tubo rame o plastica.

Raccordi

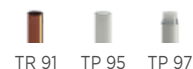

CODICE	MISURA	A	B	C	D	E	F	G	H	L			
13462100	-	45	21	50	-	-	W24x19	G 3/4	-	-	315	6	48

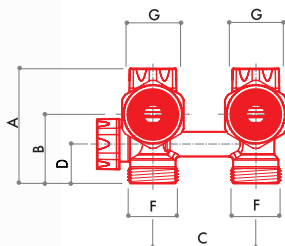

**M 173**

Distributori mono-bitubo

- attacchi al corpo scaldante con dado girevole da 3/4 femmina
- attacchi a parete 24x19 per tubo rame o plastica.

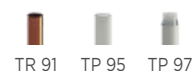
Raccordi

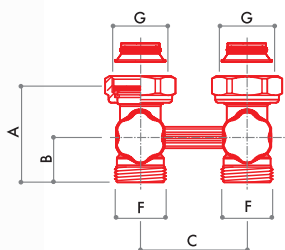

CODICE	MISURA	A	B	C	D	E	F	G	H	L			
13462101	-	57	34	50	19	-	W24x19	G 3/4	-	-	310	6	48

**M 175**

Distributori bitubo

- attacchi al corpo scaldante con dado girevole da 3/4 femmina
- attacchi pavimento 24x19 per tubo rame o plastica.

Raccordi

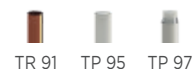

CODICE	MISURA	A	B	C	D	E	F	G	H	L			
13472100	-	45	21	50	-	-	W24x19	G 3/4	-	-	245	6	48

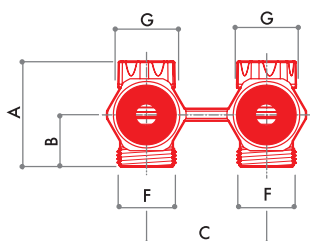
**M 177**

Distributori bitubo

- attacchi al corpo scaldante con dado girevole da 3/4 femmina
- attacchi a parete 24x19 per tubo rame o plastica.

Raccordi



CODICE	MISURA	A	B	C	D	E	F	G	H	L			
13472101	-	44	22	50	-	-	W24x19	G 3/4	-	-	255	6	48



Raccordi per tubo rame



Raccordi per tubo plastica



Raccordi per tubo multistrato



Raccordi: capitolo 7



Accessori: capitolo 1.A

DISTRIBUTORI PER IMPIANTI MONOTUBO E BITUBO PER CORPI SCALDANTI CON VALVOLA INCORPORATA: ATTACCO TUBO RAME E TUBO PLASTICA G3/4 EUROCONO

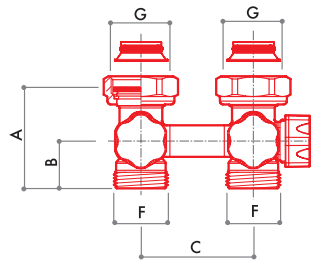

M 172

Distributori mono-bitubo

- attacchi al corpo scaldante con dado girevole da 3/4 femmina
- attacchi pavimento tipo eurocono per tubo rame o plastica.

Raccordi



CODICE	MISURA	A	B	C	D	E	F	G	H	L			
13462700	-	45	21	50	-	-	G 3/4 EK	G 3/4	-	-	325	6	48

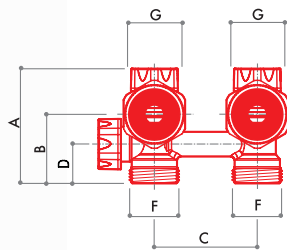

M 174

Distributori mono-bitubo

- attacchi al corpo scaldante con dado girevole da 3/4 femmina
- attacchi a parete tipo eurocono per tubo rame o plastica.

Raccordi



CODICE	MISURA	A	B	C	D	E	F	G	H	L			
13462701	-	57	34	50	19	-	G 3/4 EK	G 3/4	-	-	320	6	48

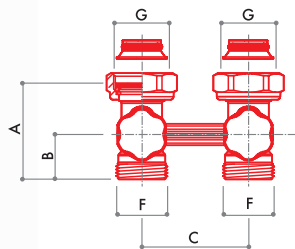

M 176

Distributori bitubo

- attacchi al corpo scaldante con dado girevole da 3/4 femmina
- attacchi pavimento tipo eurocono per tubo rame o plastica.

Raccordi



CODICE	MISURA	A	B	C	D	E	F	G	H	L			
13472700	-	45	21	50	-	-	G 3/4 EK	G 3/4	-	-	255	6	48

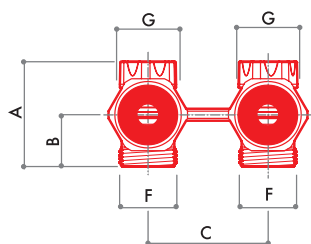

M 178

Distributori bitubo

- attacchi al corpo scaldante con dado girevole da 3/4 femmina
- attacchi a parete tipo eurocono per tubo rame o plastica.

Raccordi



CODICE	MISURA	A	B	C	D	E	F	G	H	L			
13472701	-	44	22	50	-	-	G 3/4 EK	G 3/4	-	-	260	6	48

DIAGRAMMA DI PORTATA DISTRIBUTORI

DIAGRAMMA DI REGOLAZIONI BYPASS

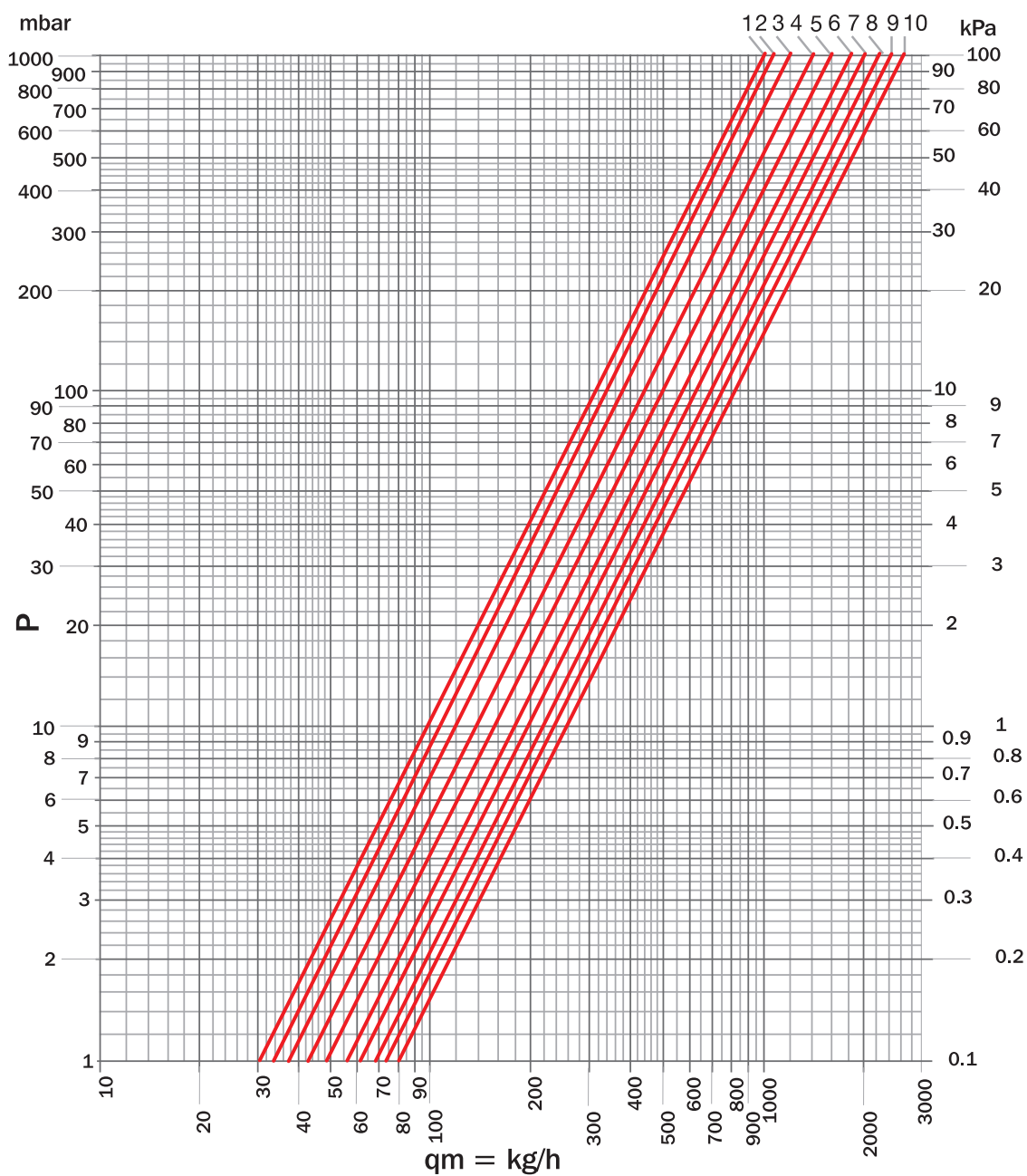

ARTICOLI	N. GIRI	Kv bypass	Kvs	POS
M 171 M 172 M 173 M 174	0	0	1,00	1
	1/4	0,13	1,13	2
	1/2	0,22	1,22	3
	3/4	0,43	1,43	4
	1	0,65	1,65	5
	1+1/4	0,80	1,80	6
	1+1/2	0,97	1,97	7
	2	1,20	2,20	8
	2+1/2	1,38	2,38	9
	3	1,60	2,60	10

DIAGRAMMA DI PORTATA DISTRIBUTORI

DIAGRAMMA DI REGOLAZIONI

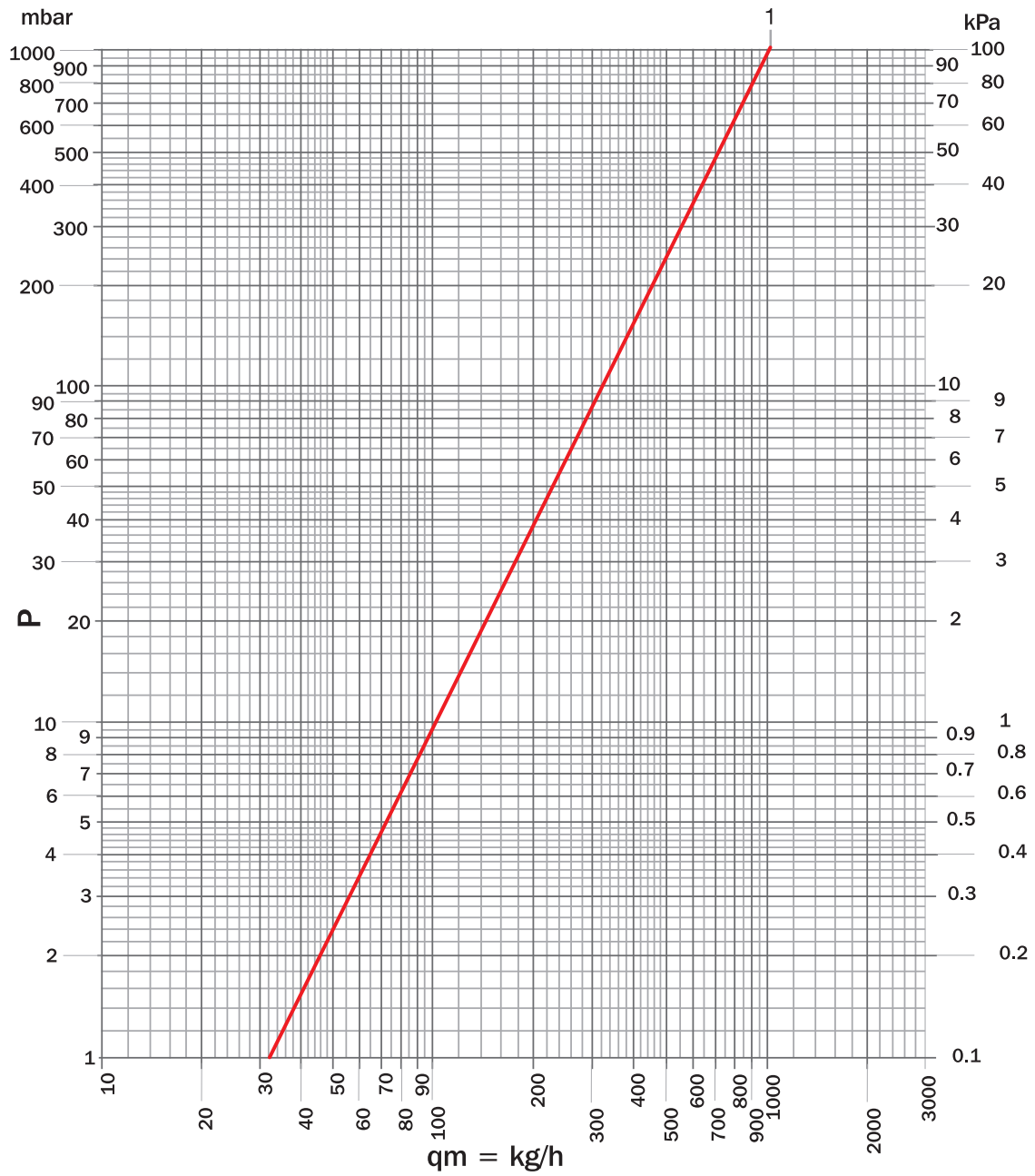

ARTICOLI	RA %	N. GIRI	Kvs	POS
M 175 M 176 M 177 M 178	100%	tutto aperto	1	1



LUXOR®



VALVOLE RADIATORE

1.A / ACCESSORI

ACCESSORI PER VALVOLE, DETENTORI, VALVOLE A 4 VIE E DISTRIBUTORI LUXOR

**507**

Dado in ottone per raccordo a sede sferica per valvole, detentori e valvole serie M (1/2 per raccordi a 90° valvole diritte serie M).

CODICE	MISURA			
1946672	G 5/8 - DN 10 3/8	28	-	-
1946676LN	G 3/4 - DN 15 1/2	25	-	-
1946682	G 1" - DN 20 3/4	45	-	-

**508**

Raccordo a sede sferica in ottone con tenuta o-ring e filetto gas conico per valvole e detentori.

CODICE	MISURA			
67891700	DN 10 3/8	24	50	400
67892100	DN 15 1/2	37	50	400
67892700	DN 20 3/4	64	30	240

**508/B**

Raccordo speciale a sede sferica in ottone con doppia tenuta o-ring per valvole e detentori.

CODICE	MISURA			
67001700	DN 3/8	39	40	320

**509**

Guarnizioni di tenuta o-ring in EPDM per raccordi a sede sferica.

CODICE	MISURA			
3424650	DN 10 3/8	-	-	-
3424662	DN 15 1/2	-	-	-
3424693	DN 20 3/4	-	-	-

**CR 498**

Dado e raccordo, nichelati, con tenuta o-ring per il collegamento delle valvole di regolazione e detentori.

CODICE	MISURA			
67901700	DN 10 3/8	60	50	400
67902100	DN 15 1/2	72	50	400
67902700	DN 20 3/4	120	20	160



**517**

Rosetta universale apribile con chiusura a scatto in PP polipropilene di colore bianco (copri foro murale).

CODICE	MISURA			
67790220	8÷22 mm	6	25	500



**518**

Rosetta apribile con chiusura a scatto in PP polipropilene di colore bianco (copri foro murale).

CODICE	MISURA			
67790217	G 3/8-18 mm	6	25	500
67790221	G 1/2	6	25	500
67790227	G 3/4	6	25	500
67790210	10 mm	6	25	500
67790212	12 mm	6	25	500
67790214	14 mm	6	25	500
67790216	16 mm	6	25	500



**M 529**

Rosetta apribile ad incastro in ABS di colore bianco (copri foro murale).
ARTICOLO IN ESAURIMENTO.

CODICE	MISURA			
67790265	Ø15÷16 mm	8	200	1200



**M 530**

Rosetta apribile doppia ad incastro in ABS di colore bianco RAL 9016 (copri foro murale).
ARTICOLO IN ESAURIMENTO.

CODICE	MISURA	INTERASSE			
67790238	Ø15÷16 mm	38 mm	17	50	300

**M 531**

Rosetta universale apribile doppia ad incastro in ABS di colore bianco RAL 9016.

CODICE	MISURA	INTERASSE			
67790240	Ø10÷16 mm	40 mm	12	100	600

ACCESSORI PER SERIE EASY E SMART

**574**

Volantino in ABS di colore bianco RAL 9016 per valvole serie Easy.

CODICE	MISURA			
4761915	-	12	-	-

**505**

Guarnizione piana in fasit 205 per tappo art. 578.

CODICE	MISURA			
3405850	-	1	-	-

**578**

Tappo in ABS di colore bianco RAL 9016 per detentori serie Easy.

CODICE	MISURA			
8761935	W19x19	2	-	-

ACCESSORI PER SERIE TEKNA

**580**

Vite ferma volantino in ottone per valvole serie Tekna.

CODICE	MISURA			
9346615	-	1	-	-

**576**

Tappo in ABS di colore bianco RAL 9016 per detentori serie Tekna.

CODICE	MISURA			
8761923	M23x19	6	-	-

ACCESSORI PER SERIE THERMOTEKNA



**VT 2600**

Volantino di comando manuale per valvole ThermoTekna. Manopola e ghiera di fissaggio in ABS di colore bianco RAL 9016.

CODICE	MISURA			
69010104	M30x1.5	16	30	240

**TM 245**

Cappuccio di protezione per valvole ThermoTekna in ABS di colore bianco RAL 9016.

CODICE	MISURA			
8761904	M30x1.5	8	50	400

**515**

Vitone termostatico con pre-regolazione per valvole serie ThermoTekna.

CODICE	MISURA			
67980006	-	24	-	-

**CH 112**

Chiave per la regolazione della portata delle valvole termostaticizzabile ThermoTekna con l'impianto in funzione.

CODICE	MISURA			
67822717	-	10	100	-

**CH 111**

Chiave per la sostituzione del vitone termostatico delle valvole serie ThermoTekna con impianto in funzione.

CODICE	MISURA			
67822720	-	2097	1	-

**583**

Guarnizioni di tenuta o-ring in EPDM per vitone termostatico serie ThermoTekna.

CODICE	MISURA			
3424704	-	-	-	-

ACCESSORI PER SERIE 50th



GS 1995

Raccordo curvo sottotraccia a 90° singolo di colore blu o rosso, senza staffa e con tappo in ottone con o-ring per prova di tenuta.

CODICE	MISURA					
66004100B	G 1/2 x (W24x19)	TR 91	TP 95	TP 97	122	8 64
66004100R	G 1/2 x (W24x19)	TR 91	TP 95	TP 97	122	8 64
66004102B	G 1/2 x G 3/4 EK	TR 91/A	TP 98	TP 99	127	8 64
66004102R	G 1/2 x G 3/4 EK	TR 91/A	TP 98	TP 99	127	8 64



M 528

Tubo di raccordo in rame cromato a tenuta morbida per scatola di distribuzione sottotraccia.

CODICE	MISURA		
67510015	G 1/2 x (Ø 15 x 140)	72	35 280
67520015	G 1/2 x (Ø 15 x 175)	86	30 240



535

Rosetta universale apribile ad incastro in ABS cromato (copri foro murale).

CODICE	MISURA		
67790224C	10 ÷ 22 mm	6	100 -



536

Rosetta universale copri tubo totale apribile ad incastro in ABS cromato (copri foro murale).

CODICE	MISURA		
67790225C	10 ÷ 18 mm	18	25 -



KT 502

Kit copri tubo ø 12-14-16mm. Rosette e tubo cromati.

CODICE	MISURA		
67790200CCA	Rosette: ø 55 mm Tubo: L 70 mm	92	1 30

ACCESSORI PER SERIE M-MT

**M 525**

Prolunga in PA 6 poliammide per sonde valvole monotubo a 4 vie.

CODICE	MISURA			
67790230	400 mm	16	50	500
67790299	1000 mm	40	-	-

**513**

Guarnizione cilindrica in PTFE per asta di comando valvole serie M 87 e M 88.

CODICE	MISURA			
3489805	-	1	-	-

**584**

Raccordo al radiatore in ottone per valvole monotubo a 4 vie M 85 e M 86.

CODICE	MISURA			
0746810M	-	155	25	200

**M 520**

Dado in ottone per raccordo al radiatore valvole monotubo a 4 vie.

CODICE	MISURA			
1946803	-	52	-	-

**586**

Sonda con deviatore di flusso in PA 6 per valvola monotubo M 85 e M 86.

CODICE	MISURA			
7761810	-	4	-	-

**M 521**

Raccordo al radiatore in ottone per valvole monotubo a 4 vie.

CODICE	MISURA			
7146803	DN 15 1/2	41	-	-
7146805	DN 20 3/4	38	-	-

**500**

Volantino in ABS di colore bianco RAL 9016 per valvole serie M 87 e M 88.

CODICE	MISURA			
4761603	-	11	-	-

**M 522**

Controsonda con deviatore di flusso in PA 6 poliammide per valvole monotubo a 4 vie serie M.

CODICE	MISURA			
7761811	-	3	-	-

**512**

Dado in ottone premiguarnizione cilindrica in PTFE per asta comando valvole serie M 87 e M 88.

CODICE	MISURA			
1946602	-	7	-	-

**M 523**

Sonda con deviatore di flusso in PA 6 poliammide per valvole monotubo a 4 vie.

CODICE	MISURA			
7761803	DN 15 1/2	7	-	-
7761805	DN 20 3/4	7	-	-

**M 524**

Guarnizione piana in fasit omnia per raccordo al radiatore valvole monotubo a 4 vie.

CODICE	MISURA			
3405855	-	2	-	-

**M 526**

Tubo in acciaio morbido cromato per collegamento dei gruppi monotubo a due attacchi (valvole a corpo reverso e valvole diritte con raccordo a 90° collegate con i distributori M 340, M 340/A, M 350, M 350/A, M 360, M 360/A, M 370 e M 370/A).

CODICE	MISURA	LUNGHEZZA			
67500115	Ø 15 mm	500 mm	172	-	-
67500215	Ø 15 mm	600 mm	208	-	-
67500315	Ø 15 mm	800 mm	278	-	-
67500015	Ø 15 mm	1000 mm	348	-	-

**M 532**

Riduzione in ottone con o-ring di tenuta per distributori mono-bitubo.

CODICE	MISURA			
69190000	3/4 M x 1/2 M	30	100	800

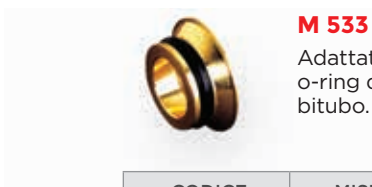
**M 533**

Adattatori eurocono in ottone con o-ring di tenuta per distributori mono-bitubo.

CODICE	MISURA			
69190200	-	10	100	800



LUXOR®

COLLETTORI SEMPLICI

2.1 / SERIE CP

CP

COLLETTORI SEMPLICI COMPONENTI



*Conforme secondo il D.M. 174/2004

La lavorazione eseguita dopo il trattamento di nichelatura rende i collettori CP conformi al D.M. 174/2004 per il trasporto di acqua potabile.

Tutti i collettori subiscono un trattamento di distensione del metallo al fine di eliminare eventuali tensioni causate dalla lavorazione.

CARATTERISTICHE TECNICHE



Max temperatura

120 °C



Max pressione

10 bar



Materiale

CW617N
UNI EN
12165:2016

ATTACCHI IMPIANTO



Tubo ferro
G 1/2



Tubo rame
W 24x19 - TR 91
G 3/4 EK - TR 91/A
G 1/2 - TR 890



Tubo plastica
W 24x19 - TP 95
G 3/4 EK - TP 98
G 1/2 - TP 93



Tubo multistrato
W 24x19 - TP 97
G 3/4 EK - TP 99
G 1/2 - TP 96

**ATTACCO
CORPO
PRINCIPALE**

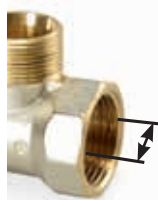

G 3/4
G 1"

INTERASSI



40 mm

Le caratteristiche del fluido dell'impianto devono essere conformi alla direttiva UNI 8065:2019.

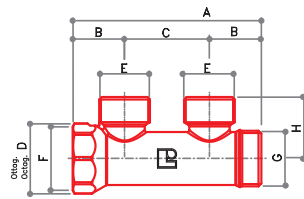
**COLLETTORI SEMPLICI COMPONENTI:
ATTACCO TUBO RAME E TUBO PLASTICA W24X19**
**CP 402**

Collettori con due attacchi laterali maschio da (W24x19). Conforme secondo il D.M. 174/2004.

Raccordi

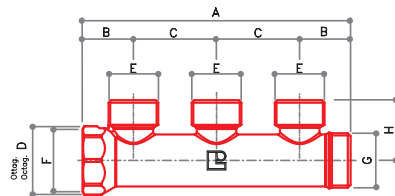

CODICE	MISURA	A	B	C	D	E	F	G	H	L			
68522700	G 3/4 x (W24x19)	89	24,5	40	31	W24x19	G 3/4	G 3/4	29	-	180	15	120
68523400	G 1" x (W24x19)	89	24,5	40	38	W24x19	G 1"	G 1"	32,5	-	210	12	96

**CP 403**

Collettori con tre attacchi laterali maschio da (W24x19). Conforme secondo il D.M. 174/2004.

Raccordi

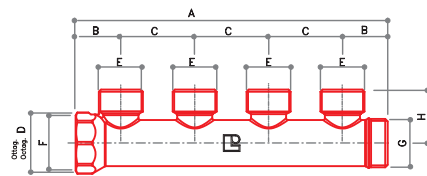

CODICE	MISURA	A	B	C	D	E	F	G	H	L			
68532700	G 3/4 x (W24x19)	129	24,5	40	31	W24x19	G 3/4	G 3/4	29	-	240	12	96
68533400	G 1" x (W24x19)	129	24,5	40	38	W24x19	G 1"	G 1"	32,5	-	290	8	64

**CP 404**

Collettori con quattro attacchi laterali maschio da (W24x19). Conforme secondo il D.M. 174/2004.

Raccordi



CODICE	MISURA	A	B	C	D	E	F	G	H	L			
68542700	G 3/4 x (W24x19)	169	24,5	40	31	W24x19	G 3/4	G 3/4	29	-	303	10	80
68543400	G 1" x (W24x19)	169	24,5	40	38	W24x19	G 1"	G 1"	32,5	-	374	6	48

**COLLETTORI SEMPLICI COMPONIBILI:
ATTACCO TUBO RAME E TUBO PLASTICA G3/4 EUROCONO**

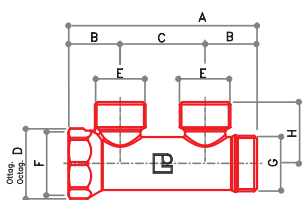

CP 412

Collettori con due attacchi laterali maschio da 3/4 eurocono. Conforme secondo il D.M. 174/2004.

Raccordi



CODICE	MISURA	A	B	C	D	E	F	G	H	L			
68522705	G 3/4 x G 3/4 EK	89	24,5	40	31	G 3/4 EK	G 3/4	G 3/4	29	-	170	15	120
68523405	G 1" x G 3/4 EK	89	24,5	40	38	G 3/4 EK	G 1"	G 1"	32,5	-	210	12	96

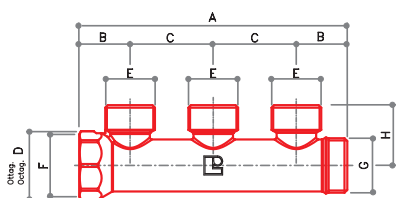

CP 413

Collettori con tre attacchi laterali maschio da 3/4 eurocono. Conforme secondo il D.M. 174/2004.

Raccordi



CODICE	MISURA	A	B	C	D	E	F	G	H	L			
68532705	G 3/4 x G 3/4 EK	129	24,5	40	31	G 3/4 EK	G 3/4	G 3/4	29	-	230	12	96
68533405	G 1" x G 3/4 EK	129	24,5	40	38	G 3/4 EK	G 1"	G 1"	32,5	-	280	8	64

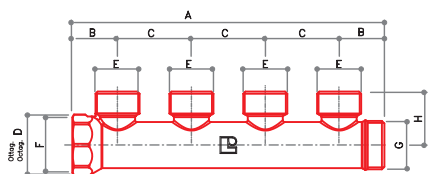

CP 414

Collettori con quattro attacchi laterali maschio da 3/4 eurocono. Conforme secondo il D.M. 174/2004.

Raccordi

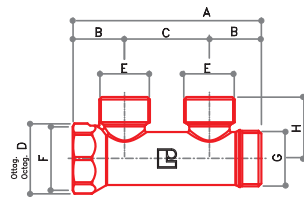

CODICE	MISURA	A	B	C	D	E	F	G	H	L			
68542705	G 3/4 x G 3/4 EK	169	24,5	40	31	G 3/4 EK	G 3/4	G 3/4	29	-	303	10	80
68543405	G 1" x G 3/4 EK	169	24,5	40	38	G 3/4 EK	G 1"	G 1"	32,5	-	340	6	48

**COLLETTORI SEMPLICI COMPONENTI:
ATTACCO TUBO RAME E TUBO PLASTICA G1/2**
**CP 422**

Collettori con due attacchi laterali maschio da 1/2. Conforme secondo il D.M. 174/2004.

Raccordi

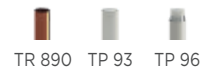

CODICE	MISURA	A	B	C	D	E	F	G	H	L			
68522701	G 3/4 x G 1/2	89	24,5	40	31	G 1/2	G 3/4	G 3/4	29	-	164	15	120
68523401	G 1" x G 1/2	89	24,5	40	38	G 1/2	G 1"	G 1"	32,5	-	210	12	96

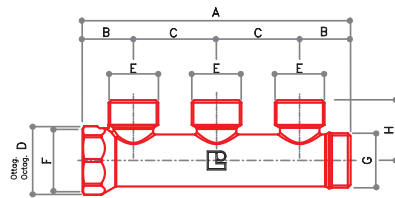
**CP 423**

Collettori con tre attacchi laterali maschio da 1/2. Conforme secondo il D.M. 174/2004.

Raccordi

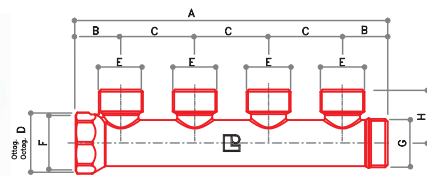

CODICE	MISURA	A	B	C	D	E	F	G	H	L			
68532701	G 3/4 x G 1/2	129	24,5	40	31	G 1/2	G 3/4	G 3/4	29	-	225	12	96
68533401	G 1" x G 1/2	129	24,5	40	38	G 1/2	G 1"	G 1"	32,5	-	275	8	64

**CP 424**

Collettori con quattro attacchi laterali maschio da 1/2. Conforme secondo il D.M. 174/2004.

Raccordi



CODICE	MISURA	A	B	C	D	E	F	G	H	L			
68542701	G 3/4 x G 1/2	169	24,5	40	31	G 1/2	G 3/4	G 3/4	29	-	300	10	80
68543401	G 1" x G 1/2	169	24,5	40	38	G 1/2	G 1"	G 1"	32,5	-	350	6	48

**COLLETTORI SEMPLICI componibili:
ATTACCO TUBO FERRO G1/2**

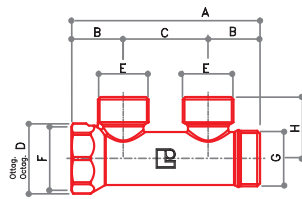

CP 442

Collettori con due attacchi laterali femmina da 1/2. Conforme secondo il D.M. 174/2004.



CODICE	MISURA	A	B	C	D	E	F	G	H	L			
68522702	G 3/4 x G 1/2	89	24,5	40	31	G 1/2	G 3/4	G 3/4	29	-	170	15	120
68523402	G 1" x G 1/2	89	24,5	40	38	G 1/2	G 1"	G 1"	32,5	-	235	12	96

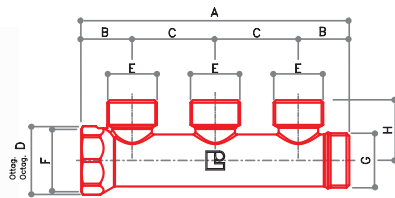

CP 443

Collettori con tre attacchi laterali femmina da 1/2. Conforme secondo il D.M. 174/2004.



CODICE	MISURA	A	B	C	D	E	F	G	H	L			
68532702	G 3/4 x G 1/2	129	24,5	40	31	G 1/2	G 3/4	G 3/4	29	-	230	12	96
68533402	G 1" x G 1/2	129	24,5	40	38	G 1/2	G 1"	G 1"	32,5	-	300	8	64

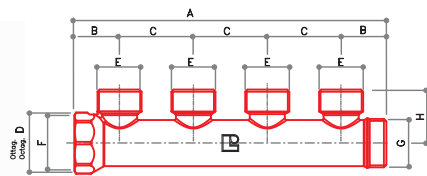

CP 444

Collettori con quattro attacchi laterali femmina da 1/2. Conforme secondo il D.M. 174/2004.



CODICE	MISURA	A	B	C	D	E	F	G	H	L			
68542702	G 3/4 x G 1/2	169	24,5	40	31	G 1/2	G 3/4	G 3/4	29	-	303	10	80
68543402	G 1" x G 1/2	169	24,5	40	38	G 1/2	G 1"	G 1"	32,5	-	420	6	48

DIAGRAMMA DI PORTATA COLLETTORI

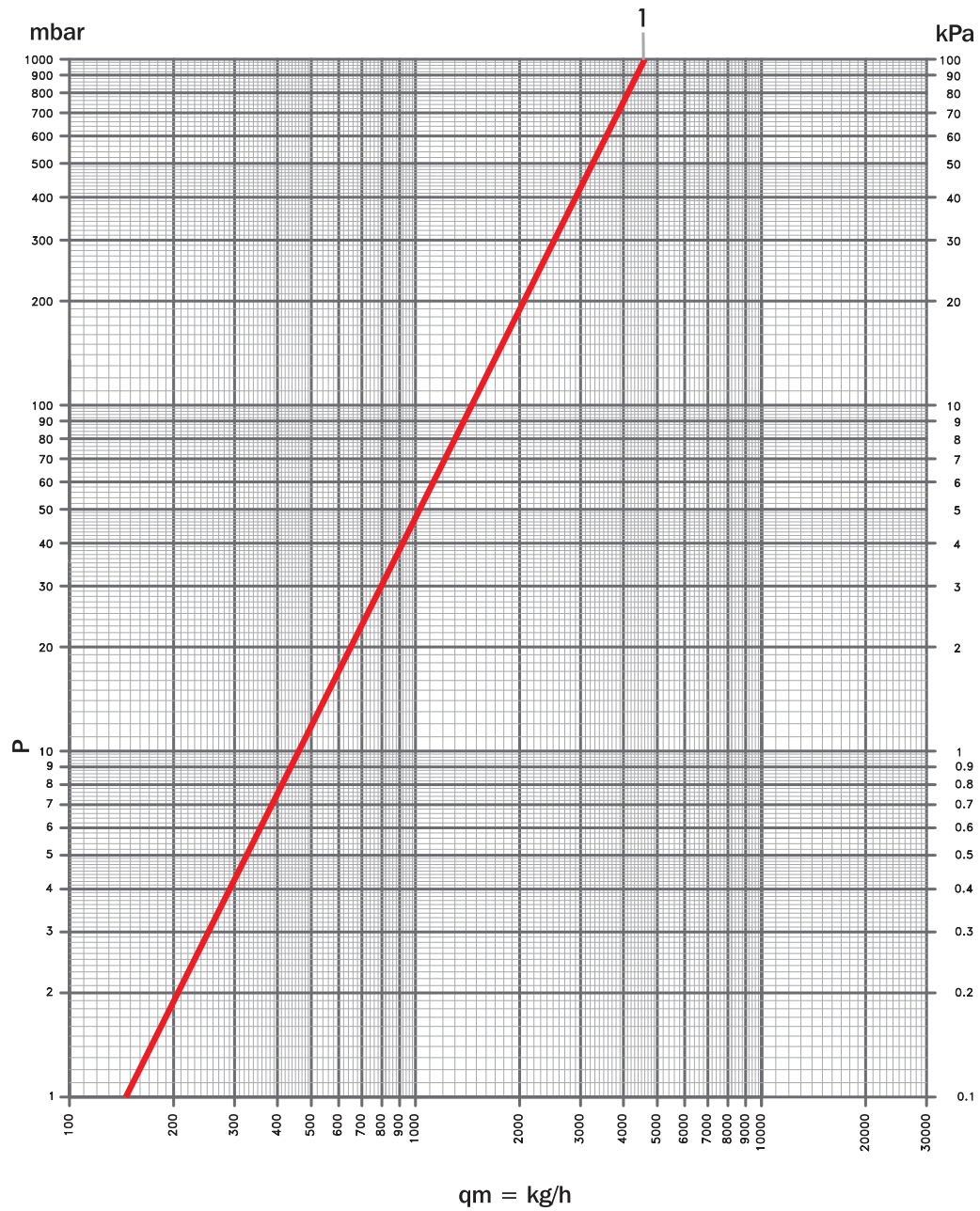

ARTICOLI	MISURA	Kvs	POS
CP 402 CP 403 CP 404 CP 412 CP 413 CP 414	G 3/4	4,6	1
CP 422 CP 423 CP 424 CP 442 CP 443 CP 444	G 1"		

CP

COLLETTORI SEMPLICI COMPONIBILI CON VALVOLE DI INTERCETTAZIONE



*Conforme secondo
il D.M. 174/2004

I collettori CP utilizzano un'asta fissa la cui tenuta è garantita da due o-rings e la tenuta in chiusura con l'otturatore è assicurata da una guarnizione piana.

Tutti i collettori vengono forniti con delle etichette che raffigurano le varie utenze.

La lavorazione eseguita dopo il trattamento di nichelatura rende i collettori CP conformi al D.M. 174/2004 per il trasporto di acqua potabile.

Tutti i collettori subiscono un trattamento di distensione del metallo al fine di eliminare eventuali tensioni causate dalla lavorazione.

ATTACCHI IMPIANTO



Max temperatura

120 °C



Max pressione

10 bar



Materiale

CW617N
UNI EN
12165:2016



Manopola

ABS bianco
RAL 9016

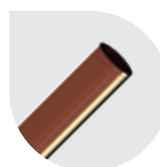

Tubo rame

W 24x19 - TR 91
G 3/4 EK - TR 91/A
G 1/2 - TR 890



Tubo plastica

W 24x19 - TP 95
G 3/4 EK - TP 98
G 1/2 - TP 93



Tubo multistrato

W 24x19 - TP 97
G 3/4 EK - TP 99
G 1/2 - TP 96

ATTACCO CORPO PRINCIPALE



G 3/4
G 1"

INTERASSI



40 mm



Le uscite dei collettori sono disassate di 4 mm per facilitare l'assemblaggio dei raccordi nella cassetta.

Le caratteristiche del fluido dell'impianto devono essere conformi alla direttiva UNI 8065:2019.

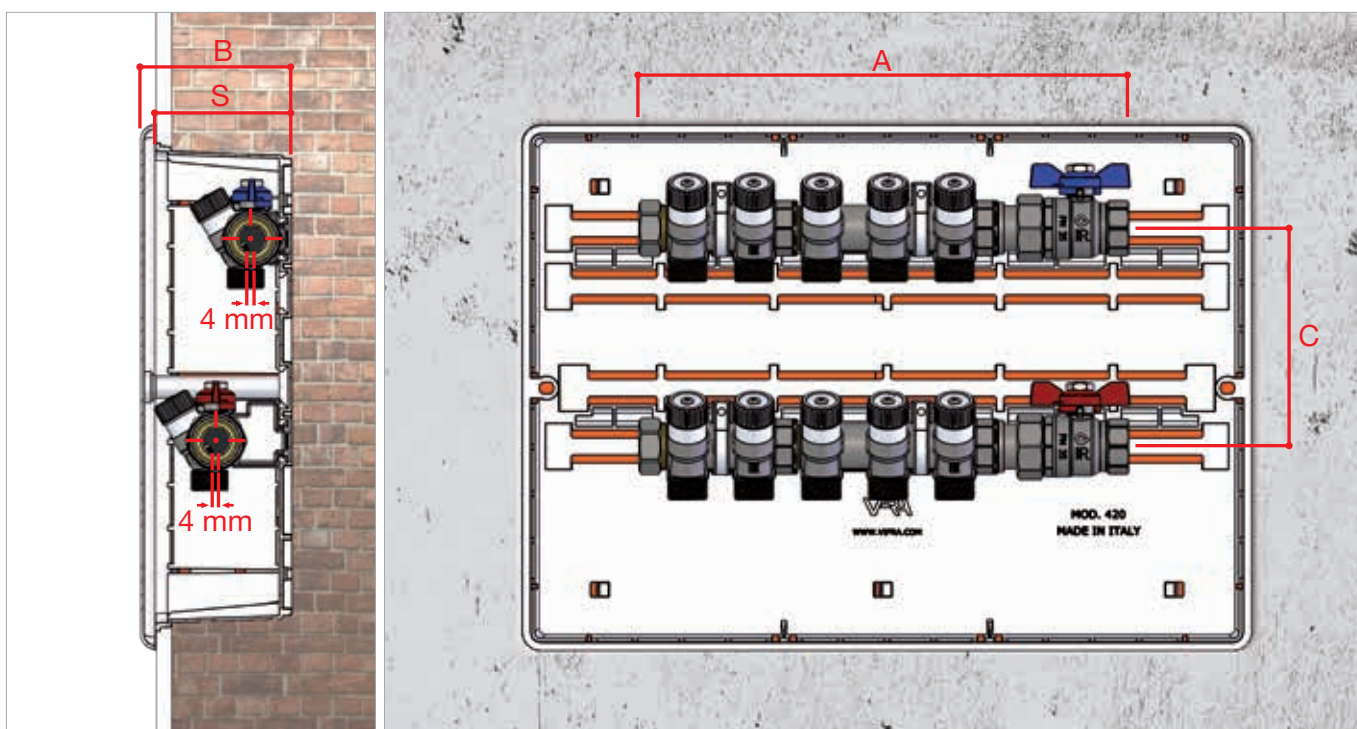

Nella tabella di seguito sono riportate tutte le misure degli ingombri relativi alla combinazione di due collettori semplici componibili con una valvola a sfera a passaggio totale.

Con l'aiuto di tali misure e prevedendo di lasciare circa 50 mm di spazio libero dalla parte della valvola a sfera, è possibile scegliere la cassetta da incasso in plastica con i relativi sistemi di fissaggio con staffe precostituite di cui si riportano le misure esterne.

		CF 477						CF 479				
N. VIE	Ø	A	B	C	S	CASSETTE	DIMENSIONE CASSETTE	B	C	S	CASSETTE	DIMENSIONE CASSETTE
2	G 3/4	175	100	110	86	68560432	272 x 332 x 86	98	140	88	68560332	290 x 330 x 88
3	G 3/4	215	100	110	86	68560432	272 x 332 x 86	98	140	88	68560332	290 x 330 x 88
4	G 3/4	255	100	110	86	68560432	272 x 332 x 86	98	140	88	68560332	290 x 330 x 88
3 + 2	G 3/4	295	100	110	86	68560440	272 x 412 x 86	98	130	88	68560342	310 x 430 x 88
3 + 3	G 3/4	335	100	110	86	68560440	272 x 412 x 86	98	130	88	68560342	310 x 430 x 88
3 + 4	G 3/4	375	100	110	86	68560450	272 x 512 x 86	98	150	88	68560352	330 x 530 x 88
4 + 4	G 3/4	415	100	110	86	68560450	272 x 512 x 86	98	150	88	68560352	330 x 530 x 88
2	G 1"	175	100	110	86	68560432	272 x 332 x 86	98	140	88	68560332	290 x 330 x 88
3	G 1"	215	100	110	86	68560432	272 x 332 x 86	98	140	88	68560332	290 x 330 x 88
4	G 1"	255	100	110	86	68560440	272 x 412 x 86	98	130	88	68560342	310 x 430 x 88
3 + 2	G 1"	295	100	110	86	68560440	272 x 412 x 86	98	130	88	68560342	310 x 430 x 88
3 + 3	G 1"	335	100	110	86	68560440	272 x 412 x 86	98	130	88	68560342	310 x 430 x 88
3 + 4	G 1"	375	100	110	86	68560450	272 x 512 x 86	98	150	88	68560352	330 x 530 x 88
4 + 4	G 1"	415	100	110	86	68560450	272 x 512 x 86	98	150	88	68560352	330 x 530 x 88

**COLLETTORI SEMPLICI COMPONIBILI CON VALVOLE DI INTERCETTAZIONE:
ATTACCO TUBO RAME E TUBO PLASTICA W24x19**

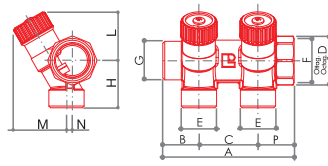

CP 432

Collettore semplice componibile a 2 vie con valvole di intercettazione. Attacco tubo rame e tubo plastica (W24x19). Conforme secondo il D.M. 174/2004.

Raccordi



CODICE	MISURA	A	B	C	D	E	F	G	H	L	M	N	P			
68512702	G 3/4 x (W24x19)	91,5	25	40	31	W24x19	G 3/4	G 3/4	32	34	36	4	26,5	300	6	48
68513402	G 1" x (W24x19)	91	24,5	40	38	W24x19	G 1"	G 1"	34	36	40	3	26,5	320	5	40

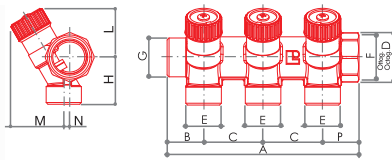

CP 433

Collettore semplice componibile a 3 vie con valvole di intercettazione. Attacco tubo rame e tubo plastica (W24x19). Conforme secondo il D.M. 174/2004.

Raccordi



CODICE	MISURA	A	B	C	D	E	F	G	H	L	M	N	P			
68512703	G 3/4 x (W24x19)	131,5	25	40	31	W24x19	G 3/4	G 3/4	32	34	36	4	26,5	432	5	40
68513403	G 1" x (W24x19)	131	24,5	40	38	W24x19	G 1"	G 1"	34	36	40	3	26,5	458	4	32

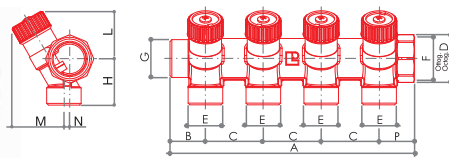

CP 434

Collettore semplice componibile a 4 vie con valvole di intercettazione. Attacco tubo rame e tubo plastica (W24x19). Conforme secondo il D.M. 174/2004.

Raccordi

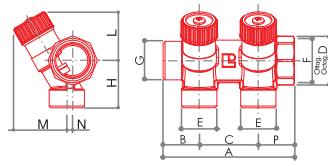

CODICE	MISURA	A	B	C	D	E	F	G	H	L	M	N	P			
68512704	G 3/4 x (W24x19)	171,5	25	40	31	W24x19	G 3/4	G 3/4	32	34	36	4	26,5	562	4	32
68513404	G 1" x (W24x19)	171	24,5	40	38	W24x19	G 1"	G 1"	34	36	40	3	26,5	640	3	24

**COLLETTORI SEMPLICI COMPONENTI CON VALVOLE DI INTERCETTAZIONE:
ATTACCO TUBO RAME E TUBO PLASTICA G3/4 EUROCONO**
**CP 452**

Collettore semplice componibile a 2 vie con valvole di intercettazione. Attacco tubo rame e tubo plastica G 3/4 EK. Conforme secondo il D.M. 174/2004.

Raccordi

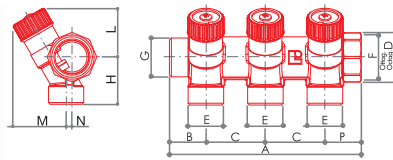

CODICE	MISURA	A	B	C	D	E	F	G	H	L	M	N	P			
68512802	G 3/4 x G 3/4 EK	91,5	25	40	31	G 3/4 EK	G 3/4	G 3/4	32	34	36	4	26,5	309	6	48
68513502	G 1" x G 3/4 EK	91	24,5	40	38	G 3/4 EK	G 1"	G 1"	34	36	40	3	26,5	337	5	40

**CP 453**

Collettore semplice componibile a 3 vie con valvole di intercettazione. Attacco tubo rame e tubo plastica G 3/4 EK. Conforme secondo il D.M. 174/2004.

Raccordi

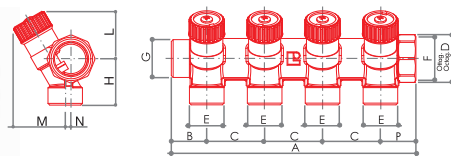

CODICE	MISURA	A	B	C	D	E	F	G	H	L	M	N	P			
68512803	G 3/4 x G 3/4 EK	131,5	25	40	31	G 3/4 EK	G 3/4	G 3/4	32	34	36	4	26,5	430	5	40
68513503	G 1" x G 3/4 EK	131	24,5	40	38	G 3/4 EK	G 1"	G 1"	34	36	40	3	26,5	490	4	32

**CP 454**

Collettore semplice componibile a 4 vie con valvole di intercettazione. Attacco tubo rame e tubo plastica G 3/4 EK. Conforme secondo il D.M. 174/2004.

Raccordi



CODICE	MISURA	A	B	C	D	E	F	G	H	L	M	N	P			
68512804	G 3/4 x G 3/4 EK	171,5	25	40	31	G 3/4 EK	G 3/4	G 3/4	32	34	36	4	26,5	562	4	32
68513504	G 1" x G 3/4 EK	171	24,5	40	38	G 3/4 EK	G 1"	G 1"	34	36	40	3	26,5	640	3	24

**COLLETTORI SEMPLICI COMPONIBILI CON VALVOLE DI INTERCETTAZIONE:
ATTACCO TUBO RAME E TUBO PLASTICA G1/2**

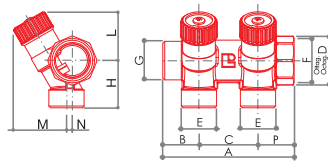

CP 462

Collettore semplice componibile a 2 vie con valvole di intercettazione. Attacco tubo rame e tubo plastica G 1/2. Conforme secondo il D.M. 174/2004.

Raccordi



CODICE	MISURA	A	B	C	D	E	F	G	H	L	M	N	P	⚖️	📦	📦
68512602	G 3/4 x G 1/2	91,5	25	40	31	G 1/2	G 3/4	G 3/4	32	34	36	4	26,5	309	6	48
68513302	G 1" x G 1/2	91	24,5	40	38	G 1/2	G 1"	G 1"	34	36	40	3	26,5	335	5	40

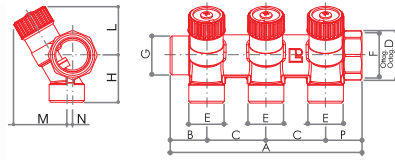

CP 463

Collettore semplice componibile a 3 vie con valvole di intercettazione. Attacco tubo rame e tubo plastica G 1/2. Conforme secondo il D.M. 174/2004.

Raccordi



CODICE	MISURA	A	B	C	D	E	F	G	H	L	M	N	P	⚖️	📦	📦
68512603	G 3/4 x G 1/2	131,5	25	40	31	G 1/2	G 3/4	G 3/4	32	34	36	4	26,5	430	5	40
68513303	G 1" x G 1/2	131	24,5	40	38	G 1/2	G 1"	G 1"	34	36	40	3	26,5	487	4	32

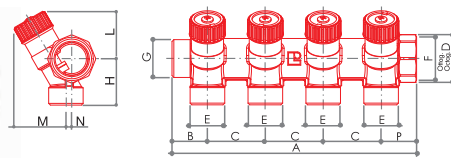

CP 464

Collettore semplice componibile a 4 vie con valvole di intercettazione. Attacco tubo rame e tubo plastica G 1/2. Conforme secondo il D.M. 174/2004.

Raccordi



CODICE	MISURA	A	B	C	D	E	F	G	H	L	M	N	P	⚖️	📦	📦
68512604	G 3/4 x G 1/2	171,5	25	40	31	G 1/2	G 3/4	G 3/4	32	34	36	4	26,5	562	4	32
68513304	G 1" x G 1/2	171	24,5	40	38	G 1/2	G 1"	G 1"	34	36	40	3	26,5	636	3	24

RICAMBI



IU 436

Etichetta con indicazioni utenze per collettori sanitari.

CODICE	MISURA			
ETICHCS	-	-	-	-



IU 437

Coppia di dischetti in alluminio rosso/blu ed indicazione utenze per collettori sanitari.

CODICE	MISURA			
6801615	-	1	-	-



571

Volantino in ABS di colore bianco RAL 9016 per collettori serie CP.

CODICE	MISURA			
4761624	-	4	-	-



580

Vite ferma volantino in ottone per valvole serie Tekna.

CODICE	MISURA			
9346615	-	1	-	-

DIAGRAMMA DI PORTATA COLLETTORI

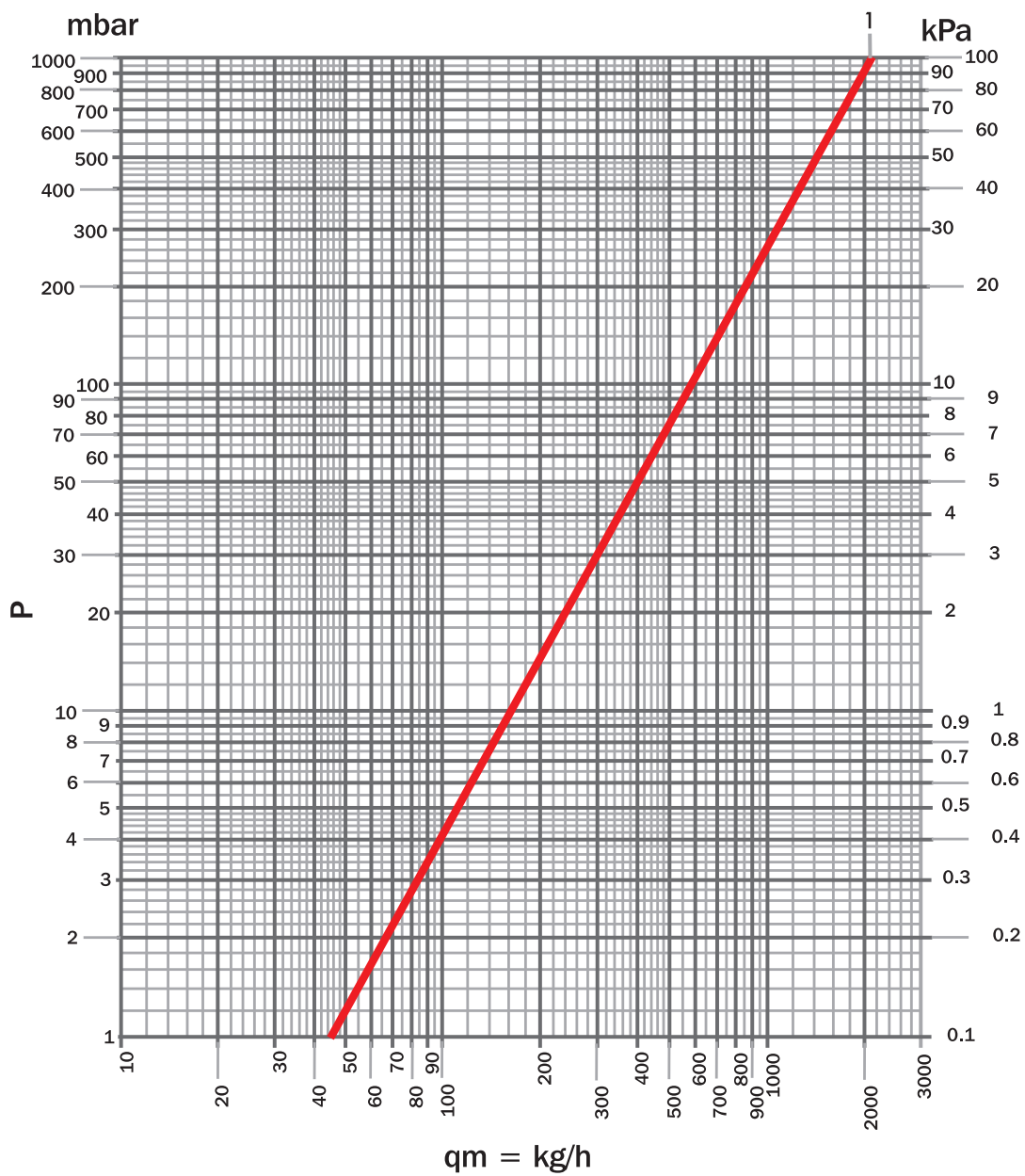

ARTICOLI	MISURA	N. GIRI	Kvs	POS
CP 432 CP 433 CP 434 CP 452 CP 453 CP 454 CP 462 CP 463 CP 464	G 3/4	tutto aperto	2,1	1
	G 1"			

CP

COLLETTORI SEMPLICI COMPONENTI CON FILETTI IN FASE E VALVOLE DI INTERCETTAZIONE



*Conforme secondo il D.M. 174/2004

I collettori CP utilizzano un'asta fissa la cui tenuta è garantita da due o-rings e la tenuta in chiusura con l'otturatore è assicurata da una guarnizione piana.

Tutti i collettori vengono forniti con delle etichette che raffigurano le varie utenze.

La lavorazione eseguita dopo il trattamento di nichelatura rende i collettori CP conformi al D.M. 174/2004 per il trasporto di acqua potabile.

Tutti i collettori subiscono un trattamento di distensione del metallo al fine di eliminare eventuali tensioni causate dalla lavorazione.

CARATTERISTICHE TECNICHE



Max temperatura

120 °C



Max pressione

10 bar



Materiale

CW617N
UNI EN
12165:2016



Manopola

ABS bianco
RAL 9016

ATTACCHI IMPIANTO

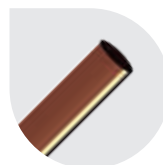

Tubo rame

W 24x19 - TR 91
G 3/4 EK - TR 91/A
G 1/2 - TR 890

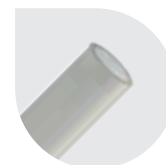

Tubo plastica

W 24x19 - TP 95
G 3/4 EK - TP 98
G 1/2 - TP 93



Tubo multistrato

W 24x19 - TP 97
G 3/4 EK - TP 99
G 1/2 - TP 96

ATTACCO CORPO PRINCIPALE



G 3/4
G 1"

INTERASSI



Le uscite dei collettori sono disassate di 4 mm per facilitare l'assemblaggio dei raccordi nella cassetta.

ALLINEAMENTO AUTOMATICO

I collettori CP con filetti in fase si collegano tra loro in modo semplice e intuitivo. Grazie alla fasatura dei filetti, i collettori CP risultano sempre allineati e la tenuta è garantita da una guarnizione O-ring.

I collettori non necessitano quindi di alcun elemento intermedio di sigillatura (come ptfе, canapa, ecc) velocizzando l'installazione.

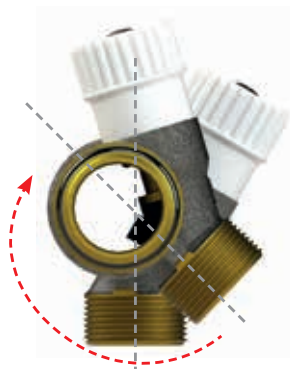

Le caratteristiche del fluido dell'impianto devono essere conformi alla direttiva UNI 8065:2019.

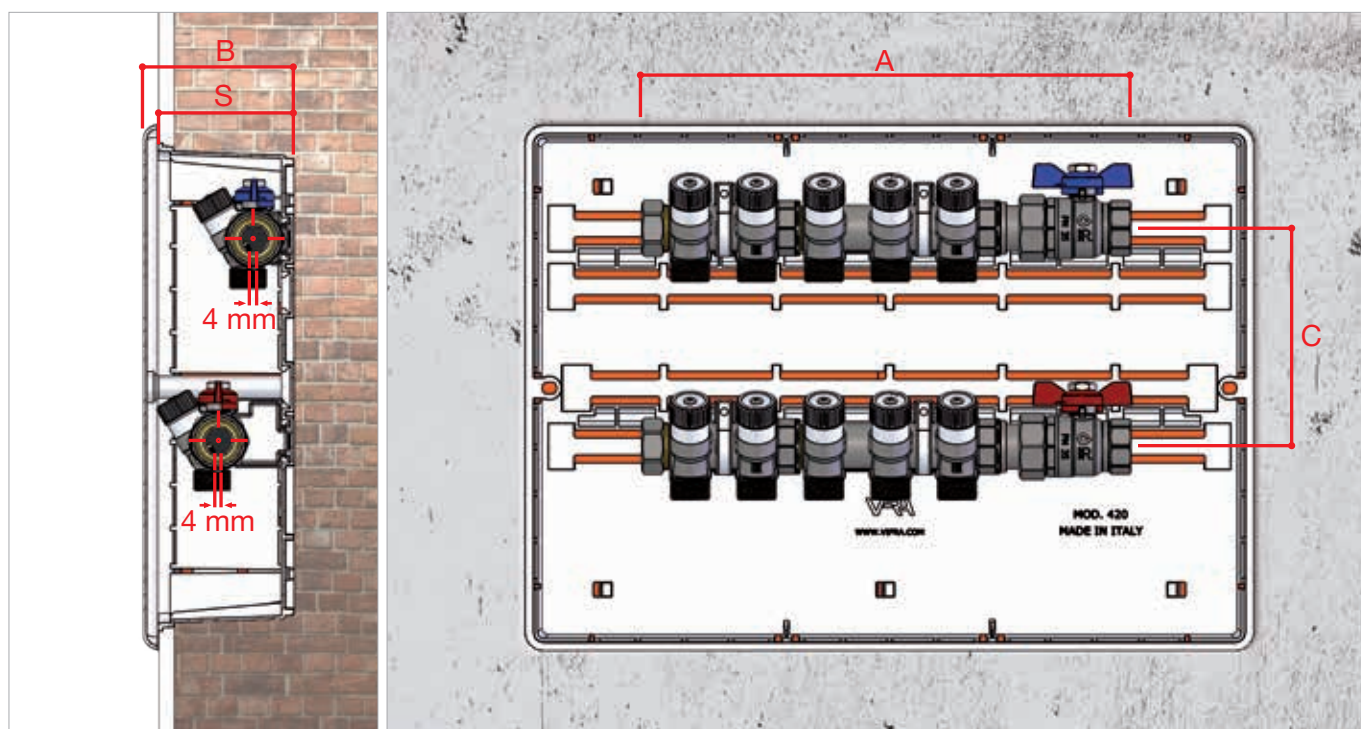

Nella tabella di seguito sono riportate tutte le misure degli ingombri relativi alla combinazione di due collettori semplici componibili con una valvola a sfera a passaggio totale.

Con l'aiuto di tali misure e prevedendo di lasciare circa 50 mm di spazio libero dalla parte della valvola a sfera, è possibile scegliere la cassetta da incasso in plastica con i relativi sistemi di fissaggio con staffe precostituite di cui si riportano le misure esterne.

		CF 477						
N. VIE	Ø	A	B	C	S	CASSETTE	DIMENSIONE CASSETTE	
2	G 3/4	175	100	110	86	68560432	272 x 332 x 86	
3	G 3/4	215	100	110	86	68560432	272 x 332 x 86	
4	G 3/4	255	100	110	86	68560432	272 x 332 x 86	
3 + 2	G 3/4	295	100	110	86	68560440	272 x 412 x 86	
3 + 3	G 3/4	335	100	110	86	68560440	272 x 412 x 86	
3 + 4	G 3/4	375	100	110	86	68560450	272 x 512 x 86	
4 + 4	G 3/4	415	100	110	86	68560450	272 x 512 x 86	

2	G 1"	175	100	110	86	68560432	272 x 332 x 86
3	G 1"	215	100	110	86	68560432	272 x 332 x 86
4	G 1"	255	100	110	86	68560440	272 x 412 x 86
3 + 2	G 1"	295	100	110	86	68560440	272 x 412 x 86
3 + 3	G 1"	335	100	110	86	68560440	272 x 412 x 86
3 + 4	G 1"	375	100	110	86	68560450	272 x 512 x 86
4 + 4	G 1"	415	100	110	86	68560450	272 x 512 x 86

		CF 479					
B	C	S	CASSETTE	DIMENSIONE CASSETTE			
98	140	88	68560332	290 x 330 x 88			
98	140	88	68560332	290 x 330 x 88			
98	140	88	68560332	290 x 330 x 88			
98	130	88	68560342	310 x 430 x 88			
98	130	88	68560342	310 x 430 x 88			
98	150	88	68560352	330 x 530 x 88			
98	150	88	68560352	330 x 530 x 88			

98	140	88	68560332	290 x 330 x 88		
98	140	88	68560332	290 x 330 x 88		
98	130	88	68560342	310 x 430 x 88		
98	130	88	68560342	310 x 430 x 88		
98	130	88	68560342	310 x 430 x 88		
98	150	88	68560352	330 x 530 x 88		
98	150	88	68560352	330 x 530 x 88		

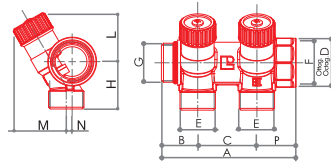
**COLLETTORI SEMPLICI COMPONIBILI CON FILETTI IN FASE E VALVOLE DI INTERCETTAZIONE:
ATTACCO TUBO RAME E TUBO PLASTICA W24X19**
**CP 432/FR**

Collettore semplice componibile con filetti in fase a 2 vie con valvole di intercettazione. Attacco tubo rame e tubo plastica (W24x19). Conforme secondo il D.M. 174/2004.

Raccordi

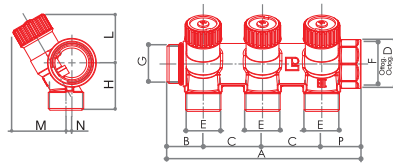

CODICE	MISURA	A	B	C	D	E	F	G	H	L	M	N	P			
68512702FR	G 3/4 x (W24x19)	91	24,5	40	31	W24x19	G 3/4	G 3/4	32	34	36	4	26,5	305	6	48
68513402FR	G 1" x (W24x19)	91,5	24,5	40	38	W24x19	G 1"	G 1"	34	36	40	3	27	325	5	40

**CP 433/FR**

Collettore semplice componibile con filetti in fase a 3 vie con valvole di intercettazione. Attacco tubo rame e tubo plastica (W24x19). Conforme secondo il D.M. 174/2004.

Raccordi

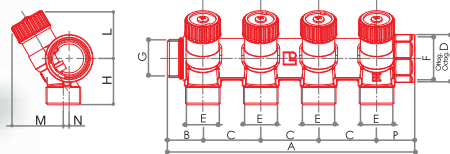

CODICE	MISURA	A	B	C	D	E	F	G	H	L	M	N	P			
68512703FR	G 3/4 x (W24x19)	131	24,5	40	31	W24x19	G 3/4	G 3/4	32	34	36	4	26,5	437	5	40
68513403FR	G 1" x (W24x19)	131,5	24,5	40	38	W24x19	G 1"	G 1"	34	36	40	3	27	463	4	32

**CP 434/FR**

Collettore semplice componibile con filetti in fase a 4 vie con valvole di intercettazione. Attacco tubo rame e tubo plastica (W24x19). Conforme secondo il D.M. 174/2004.

Raccordi



CODICE	MISURA	A	B	C	D	E	F	G	H	L	M	N	P			
68512704FR	G 3/4 x (W24x19)	171	24,5	40	31	W24x19	G 3/4	G 3/4	32	34	36	4	26,5	567	4	32
68513404FR	G 1" x (W24x19)	171,5	24,5	40	38	W24x19	G 1"	G 1"	34	36	40	3	27	645	3	24

COLLETTORI SEMPLICI COMPONENTI CON FILETTI IN FASE E VALVOLE DI INTERCETTAZIONE: ATTACCO TUBO RAME E TUBO PLASTICA G3/4 EUROCONO

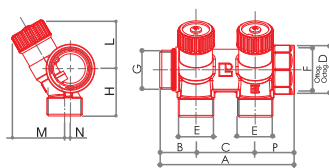

CP 452/FR

Collettore semplice componibile con filetti in fase a 2 vie con valvole di intercettazione. Attacco tubo rame e tubo plastica G 3/4 EK. Conforme secondo il D.M. 174/2004.

Raccordi



CODICE	MISURA	A	B	C	D	E	F	G	H	L	M	N	P	⚖️	📦	📦
68512802FR	G 3/4 x G 3/4 EK	91	24,5	40	31	G 3/4 EK	G 3/4	G 3/4	32	34	36	4	26,5	325	6	48
68513502FR	G 1" x G 3/4 EK	91,5	24,5	40	38	G 3/4 EK	G 1"	G 1"	34	36	40	3	27	342	5	40

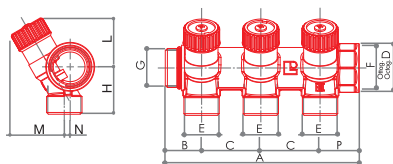

CP 453/FR

Collettore semplice componibile con filetti in fase a 3 vie con valvole di intercettazione. Attacco tubo rame e tubo plastica G 3/4 EK. Conforme secondo il D.M. 174/2004.

Raccordi



CODICE	MISURA	A	B	C	D	E	F	G	H	L	M	N	P	⚖️	📦	📦
68512803FR	G 3/4 x G 3/4 EK	131	24,5	40	31	G 3/4 EK	G 3/4	G 3/4	32	34	36	4	26,5	435	5	40
68513503FR	G 1" x G 3/4 EK	131,5	24,5	40	38	G 3/4 EK	G 1"	G 1"	34	36	40	3	27	495	4	32

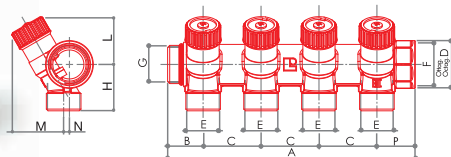

CP 454/FR

Collettore semplice componibile con filetti in fase a 4 vie con valvole di intercettazione. Attacco tubo rame e tubo plastica G 3/4 EK. Conforme secondo il D.M. 174/2004.

Raccordi

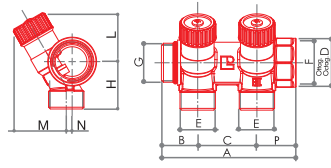

CODICE	MISURA	A	B	C	D	E	F	G	H	L	M	N	P	⚖️	📦	📦
68512804FR	G 3/4 x G 3/4 EK	171	24,5	40	31	G 3/4 EK	G 3/4	G 3/4	32	34	36	4	26,5	567	4	32
68513504FR	G 1" x G 3/4 EK	171,5	24,5	40	38	G 3/4 EK	G 1"	G 1"	34	36	40	3	27	645	3	24

**COLLETTORI SEMPLICI COMPONIBILI CON FILETTI IN FASE E VALVOLE DI INTERCETTAZIONE:
ATTACCO TUBO RAME E TUBO PLASTICA G1/2**
**CP 462/FR**

Collettore semplice componibile con filetti in fase a 2 vie con valvole di intercettazione. Attacco tubo rame e tubo plastica G 1/2. Conforme secondo il D.M. 174/2004.

Raccordi

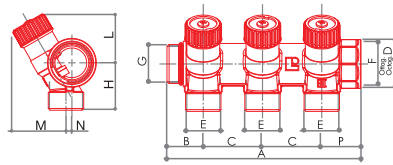

CODICE	MISURA	A	B	C	D	E	F	G	H	L	M	N	P			
68512602FR	G 3/4 x G 1/2	91	24,5	40	31	G 1/2	G 3/4	G 3/4	32	34	36	4	26,5	314	6	48
68513302FR	G 1" x G 1/2	91,5	24,5	40	38	G 1/2	G 1"	G 1"	34	36	40	3	27	340	5	40

**CP 463/FR**

Collettore semplice componibile con filetti in fase a 3 vie con valvole di intercettazione. Attacco tubo rame e tubo plastica G 1/2. Conforme secondo il D.M. 174/2004.

Raccordi

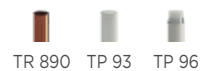

CODICE	MISURA	A	B	C	D	E	F	G	H	L	M	N	P			
68512603FR	G 3/4 x G 1/2	131	24,5	40	31	G 1/2	G 3/4	G 3/4	32	34	36	4	26,5	435	5	40
68513303FR	G 1" x G 1/2	131,5	24,5	40	38	G 1/2	G 1"	G 1"	34	36	40	3	27	492	4	32

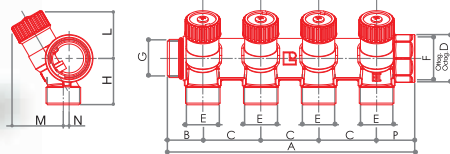
**CP 464/FR**

Collettore semplice componibile con filetti in fase a 4 vie con valvole di intercettazione. Attacco tubo rame e tubo plastica G 1/2. Conforme secondo il D.M. 174/2004.

Raccordi



CODICE	MISURA	A	B	C	D	E	F	G	H	L	M	N	P			
68512604FR	G 3/4 x G 1/2	171	24,5	40	31	G 1/2	G 3/4	G 3/4	32	34	36	4	26,5	567	4	32
68513304FR	G 1" x G 1/2	171,5	24,5	40	38	G 1/2	G 1"	G 1"	34	36	40	3	27	641	3	24

RICAMBI



IU 436

Etichetta con indicazioni utenze per collettori sanitari.

CODICE	MISURA			
ETICHCS	-	-	-	-



IU 437

Coppia di dischetti in alluminio rosso/blu ed indicazione utenze per collettori sanitari.

CODICE	MISURA			
6801615	-	1	-	-



571

Volantino in ABS di colore bianco RAL 9016 per collettori serie CP.

CODICE	MISURA			
4761624	-	4	-	-



580

Vite ferma volantino in ottone per valvole serie Tekna.

CODICE	MISURA			
9346615	-	1	-	-

DIAGRAMMA DI PORTATA COLLETTORI

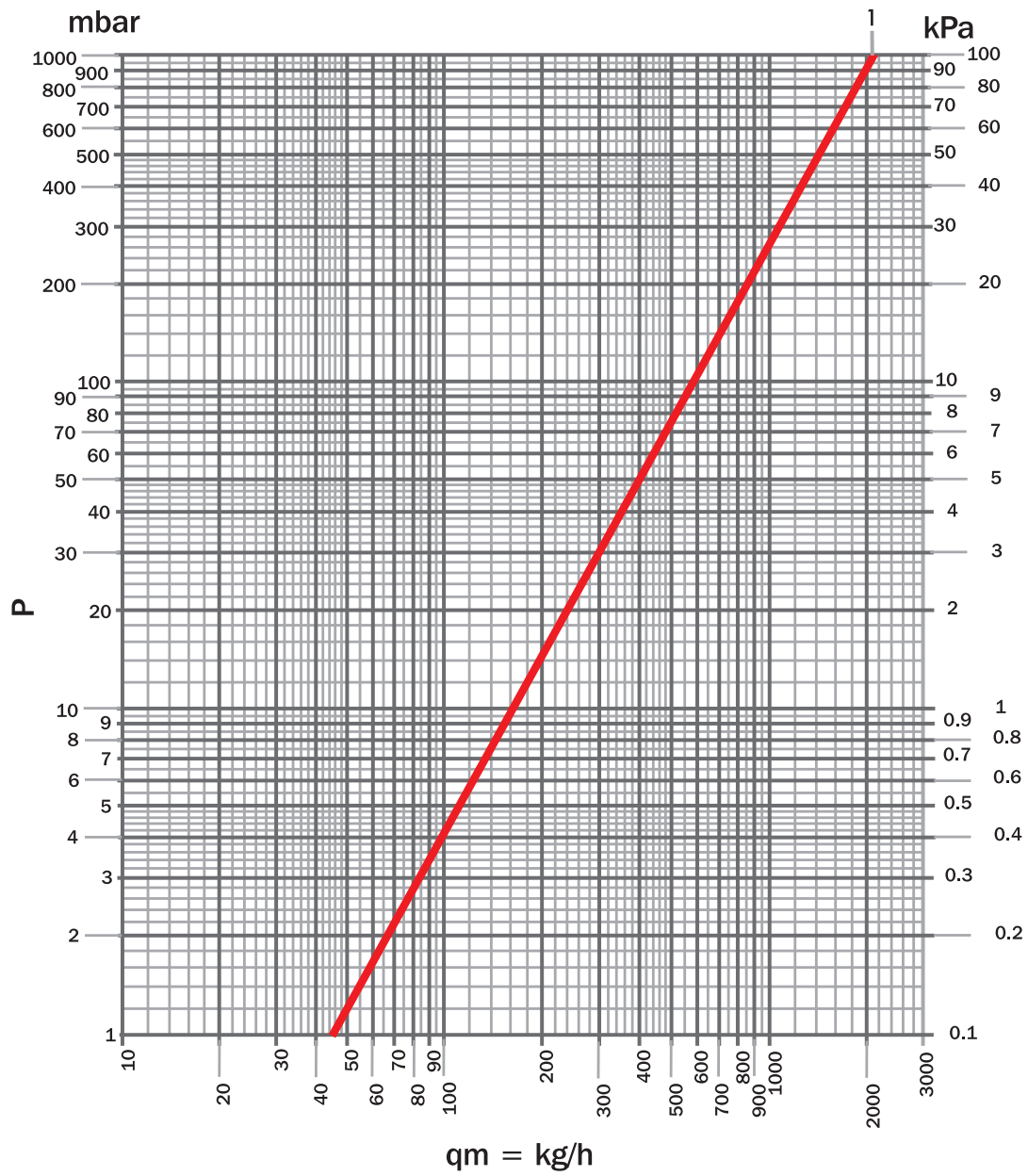

ARTICOLI	MISURA	N. GIRI	Kvs	POS
CP 432/FR CP 433/FR CP 434/FR CP 452/FR CP 453/FR CP 454/FR CP 462/FR CP 463/FR CP 464/FR	G 3/4	tutto aperto	2,1	1
	G 1"			



LUXOR®

COLLETTORI componibili con valvole frontali

2.2 / SERIE CV

CV

COLLETTORI componibili con valvole frontali



I collettori componibili con valvole d'intercettazione frontali possono essere collegati tra loro in modo pratico e semplice. Grazie all'ausilio delle valvole d'intercettazione si possono rendere indipendenti le varie utenze ed identificarle utilizzando i due dischetti serigrafati. I collettori permettono di regolare e bilanciare ogni singola utenza. Sono disponibili modelli da 2 a 4 uscite.

zando i due dischetti serigrafati. I collettori permettono di regolare e bilanciare ogni singola utenza. Sono disponibili modelli da 2 a 4 uscite.

CARATTERISTICHE TECNICHE



Max temperatura
120 °C



Max pressione di esercizio
16 bar



Max pressione differenziale
1 bar



Materiale corpo
CB753S
UNI EN
1982:2017



Materiale otturatore
CW614N
DW UNI EN
12164:2016



Materiale guarnizioni
EPDM
perossidico



Materiale guarnizione chiusura vitone
NBR



Manopola
Nylon PA6
RAL 9016



Collaudo
100%



Finitura
Cromata

ATTACCHI IMPIANTO

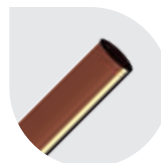

Tubo rame
W 24x19 - TR 91
G 3/4 EK - TR 91/A



Tubo plastica
W 24x19 - TP 95
G 3/4 EK - TP 98



Tubo multistrato
W 24x19 - TP 97
G 3/4 EK - TP 99

ATTACCO CORPO PRINCIPALE

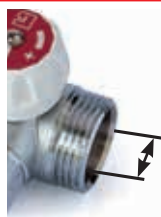

G 3/4
G 1"

INTERASSI



45 mm

Le caratteristiche del fluido dell'impianto devono essere conformi alla direttiva UNI 8065:2019.

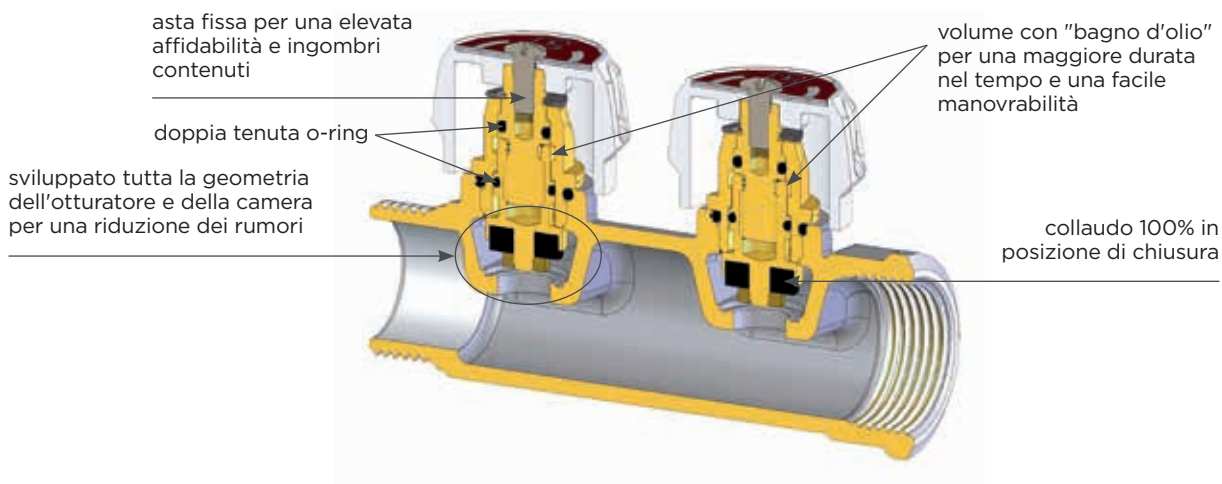

ISTRUZIONI OPERATIVE



Per identificare le utenze è possibile utilizzare le piastrine metalliche di cui è provvisto il collettore.

Per un corretto assemblaggio degli indicatori, scegliere se lasciare il lato blu o il lato rosso della piastrina visibile. La piastrina è dotata di una finestrella dalla quale si potrà leggere l'utenza servita dal collettore. Posizionare l'inserto metallico serigrafato prima della piastrina rossa o blu in modo che il nome del terminale di erogazione sia visibile dalla finestrella, come mostrato.

Una volta terminato il posizionamento dell'indicatore, fissare le piastrine metalliche alla manopola con la vite presente sulla manopola stessa.

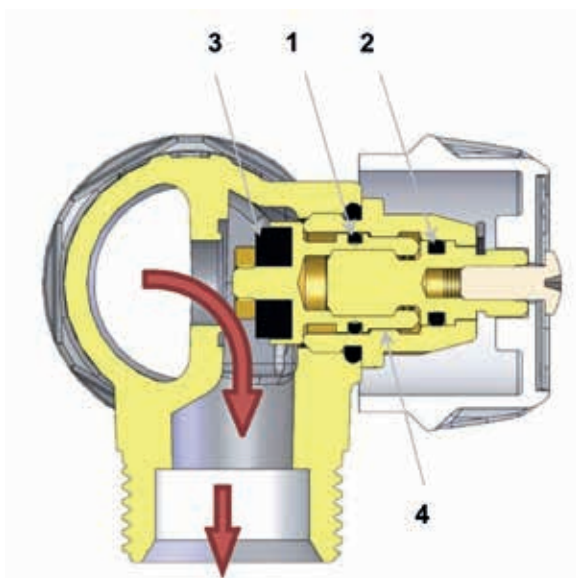

Il collettore componibile con valvole d'intercettazione frontali deve essere installato con il flusso d'acqua in mandata come da immagine qui in fianco.

Il vitone del collettore è sicuro e affidabile avendo un' asta fissa la cui tenuta è garantita da due o-rings (1-2) in EPDM perossidico mentre la tenuta in chiusura con l'otturatore è garantita da una guarnizione piana in NBR (3).

All'interno del vitone si viene a creare una camera stagna (4) dove viene depositato del grasso lubrificante. In questo modo viene garantito il movimento, di apertura e chiusura, scorrevole nel tempo.

La costruzione del vitone permette la regolazione e il bilanciamento di ogni singola utenza.

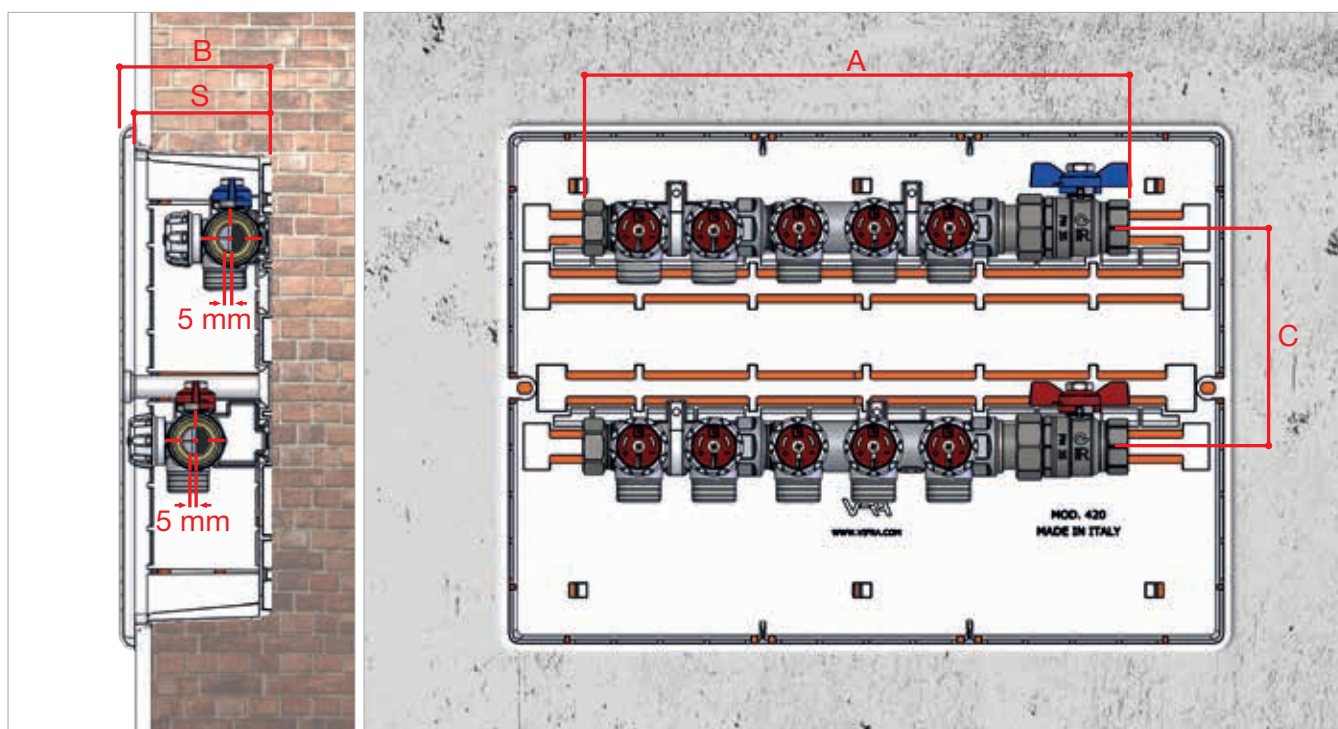

Nella tabella di seguito sono riportate tutte le misure degli ingombri relativi alla combinazione di due collettori semplici componibili con una valvola a sfera a passaggio totale.

Con l'aiuto di tali misure e prevedendo di lasciare circa 50 mm di spazio libero dalla parte della valvola a sfera, è possibile scegliere la cassetta da incasso in plastica con i relativi sistemi di fissaggio con staffe precostituite di cui si riportano le misure esterne.

CF 477							
N. VIE	Ø	A	B	C	S	CASSETTE	DIMENSIONE CASSETTE
2	G 3/4	190	100	110	86	68560432	272 x 332 x 86
3	G 3/4	235	100	110	86	68560432	272 x 332 x 86
4	G 3/4	280	100	110	86	68560432	272 x 332 x 86
2 + 3	G 3/4	330	100	110	86	68560440	272 x 412 x 86
3 + 3	G 3/4	375	100	110	86	68560440	272 x 412 x 86
3 + 4	G 3/4	420	100	110	86	68560450	272 x 512 x 86
4 + 4	G 3/4	465	100	110	86	68560450	272 x 512 x 86

2	G 1"	192	100	110	86	68560432	272 x 332 x 86
3	G 1"	238	100	110	86	68560432	272 x 332 x 86
4	G 1"	283	100	110	86	68560432	272 x 332 x 86
2 + 3	G 1"	337	100	110	86	68560440	272 x 412 x 86
3 + 3	G 1"	382	100	110	86	68560440	272 x 412 x 86
3 + 4	G 1"	427	100	110	86	68560450	272 x 512 x 86
4 + 4	G 1"	472	100	110	86	68560450	272 x 512 x 86

CF 479				
B	C	S	CASSETTE	DIMENSIONE CASSETTE
98	140	88	68560332	290 x 330 x 88
98	140	88	68560332	290 x 330 x 88
98	140	88	68560332	290 x 330 x 88
98	130	88	68560342	310 x 430 x 88
98	130	88	68560342	310 x 430 x 88
98	150	88	68560352	330 x 530 x 88
98	150	88	68560352	330 x 530 x 88

98	140	88	68560332	290 x 330 x 88
98	140	88	68560332	290 x 330 x 88
98	140	88	68560332	290 x 330 x 88
98	130	88	68560342	310 x 430 x 88
98	130	88	68560342	310 x 430 x 88
98	150	88	68560352	330 x 530 x 88
98	150	88	68560352	330 x 530 x 88

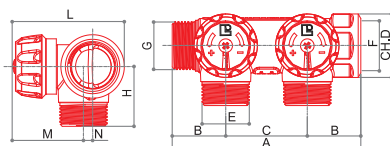
**COLLETTORI componibili con valvole frontali:
ATTACCO TUBO RAME E TUBO PLASTICA W24X19**
**CV 532**

Collettori a due vie con valvole di intercettazione frontali. Attacco tubo rame e tubo plastica (W24x19).

Raccordi

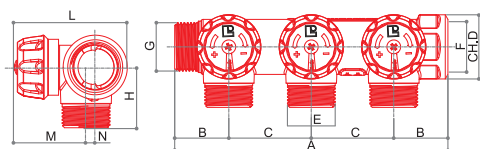

CODICE	MISURA	A	B	C	D	E	F	G	H	L	M	N			
68202702	G 3/4 x (W24x19)	104	29,5	45	32	W24x19	G 3/4	G 3/4	33	61	38,5	5	470	1	45
68203402	G 1" x (W24x19)	108	31,5	45	37	W24x19	G 1"	G 1"	36	63	38,5	5	565	1	45

**CV 533**

Collettori a tre vie con valvole di intercettazione frontali. Attacco tubo rame e tubo plastica (W24x19).

Raccordi

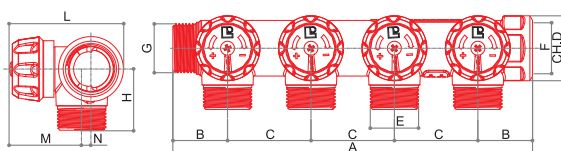

CODICE	MISURA	A	B	C	D	E	F	G	H	L	M	N			
68202703	G 3/4 x (W24x19)	149	29,5	45	32	W24x19	G 3/4	G 3/4	33	61	38,5	5	690	1	34
68203403	G 1" x (W24x19)	153	31,5	45	37	W24x19	G 1"	G 1"	36	63	38,5	5	810	1	34

**CV 534**

Collettori a quattro vie con valvole di intercettazione frontali. Attacco tubo rame e tubo plastica (W24x19).

Raccordi



CODICE	MISURA	A	B	C	D	E	F	G	H	L	M	N			
68202704	G 3/4 x (W24x19)	194	29,5	45	32	W24x19	G 3/4	G 3/4	33	61	38,5	5	890	1	25
68203404	G 1" x (W24x19)	198	31,5	45	37	W24x19	G 1"	G 1"	36	63	38,5	5	980	1	25



Raccordi per tubo rame



Raccordi per tubo plastica



Raccordi per tubo multistrato



Raccordi: capitolo 7



Accessori: capitolo 2.A

**COLLETTORI componibili con valvole frontali:
ATTACCO TUBO RAME E TUBO PLASTICA G3/4 EUROCONO**

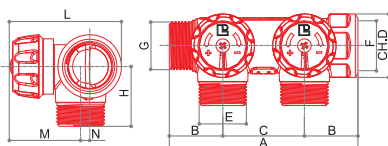

CV 552

Collettori a due vie con valvole di intercettazione frontali. Attacchi maschio G3/4 Eurocono.

Raccordi



CODICE	MISURA	A	B	C	D	E	F	G	H	L	M	N	⚖️	📦	📦
68202802	G 3/4 X G 3/4 EK	104	29,5	45	32	G 3/4 EK	G 3/4	G 3/4	33	61	38,5	5	470	1	45
68203502	G 1" X G 3/4 EK	108	31,5	45	37	G 3/4 EK	G 1"	G 1"	36	63	38,5	5	565	1	45

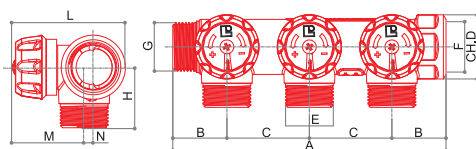

CV 553

Collettori a tre vie con valvole di intercettazione frontali. Attacchi maschio G3/4 Eurocono.

Raccordi



CODICE	MISURA	A	B	C	D	E	F	G	H	L	M	N	⚖️	📦	📦
68202803	G 3/4 X G 3/4 EK	149	29,5	45	32	G 3/4 EK	G 3/4	G 3/4	33	61	38,5	5	690	1	34
68203503	G 1" X G 3/4 EK	153	31,5	45	37	G 3/4 EK	G 1"	G 1"	36	63	38,5	5	810	1	34

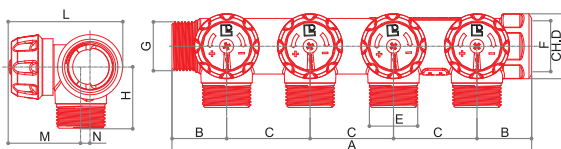

CV 554

Collettori a quattro vie con valvole di intercettazione frontali. Attacchi maschio G3/4 Eurocono.

Raccordi



CODICE	MISURA	A	B	C	D	E	F	G	H	L	M	N	⚖️	📦	📦
68202804	G 3/4 X G 3/4 EK	194	29,5	45	32	G 3/4 EK	G 3/4	G 3/4	33	61	38,5	5	890	1	25
68203504	G 1" X G 3/4 EK	198	31,5	45	37	G 3/4 EK	G 1"	G 1"	36	63	38,5	5	980	1	25

RICAMBI



IU 438

Coppia di dischetti in alluminio rosso/blu ed indicazione utenze per collettori serie CV.

CODICE	MISURA			
6801617	-	1	-	-



573

Volantino in ABS di colore bianco RAL 9016 per collettori serie CV.

CODICE	MISURA			
4761632	-	7	-	-



580

Vite ferma volantino in ottone per valvole serie Tekna.

CODICE	MISURA			
9346615	-	1	-	-

DIAGRAMMA DI PORTATA COLLETTORI

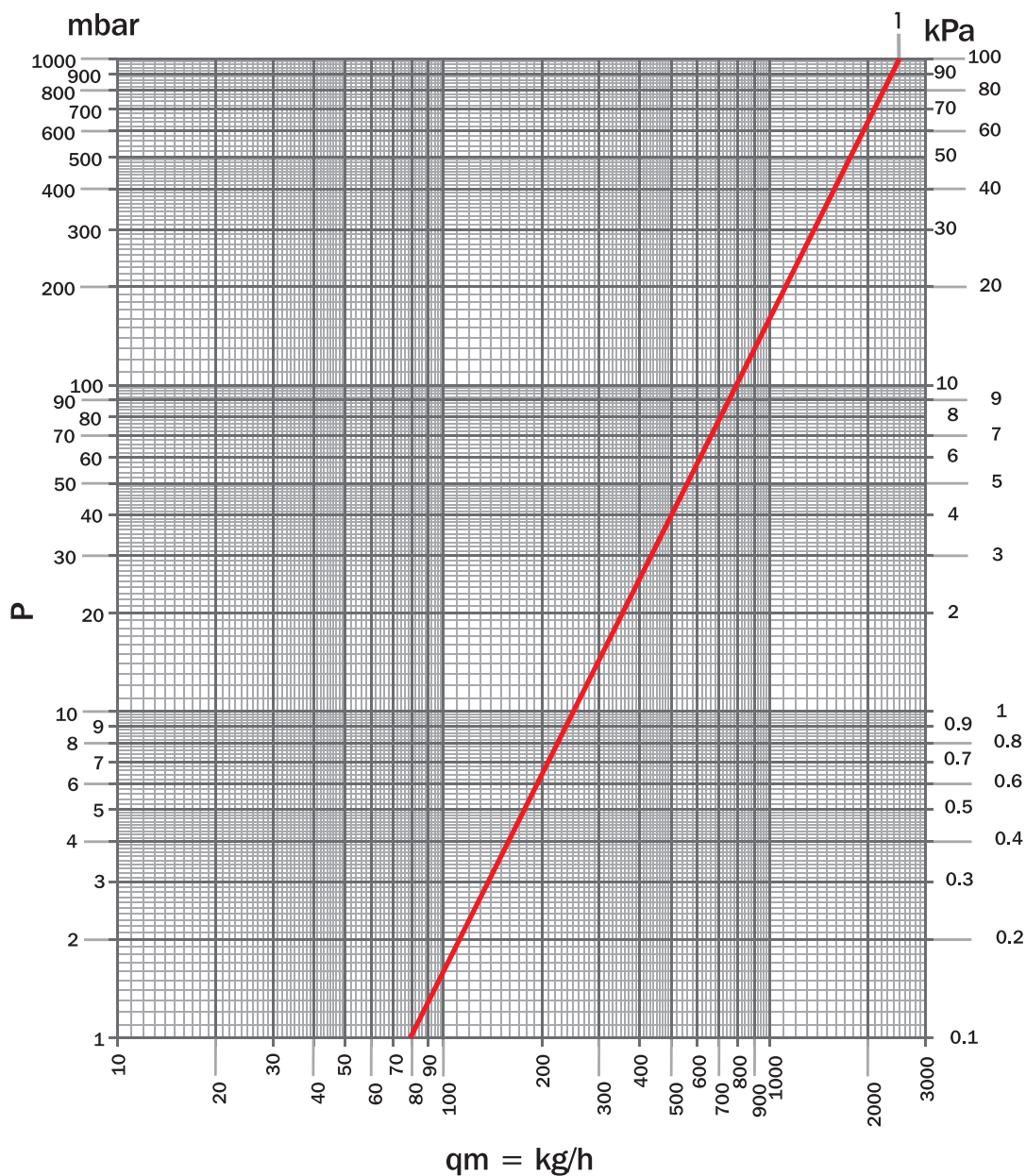

ARTICOLI	MISURA	N. GIRI	Kvs	POS
CV 552 CV 553 CV 554	G 3/4	tutto aperto	2,5	1
	G 1"			



LUXOR®

COLLETTORI COMPLANARI

2.3 / SERIE CC

CC

COLLETTORI COMPLANARI



Tutti i collettori della serie CC con i relativi accessori sono prodotti con finitura nichelata. I corpi dei collettori sono ottenuti da fusione e utilizzano ot-

tone EN 1982, con un basso contenuto di piombo. I collegamenti interni dei circuiti permettono il passaggio di portate elevate con bassissima rumorosità.

CARATTERISTICHE TECNICHE



Max temperatura

120 °C



Max pressione

10 bar



Materiale

EN 1982

ATTACCHI IMPIANTO

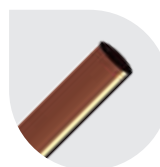

Tubo rame

W 24x19 - TR 91
G 3/4 EK - TR 91/A



Tubo plastica

W 24x19 - TP 95
G 3/4 EK - TP 98



Tubo multistrato

W 24x19 - TP 97
G 3/4 EK - TP 99

ATTACCO CORPO PRINCIPALE

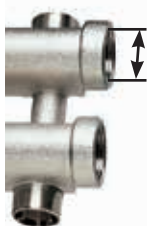

G 3/4
G 1"

INTERASSI

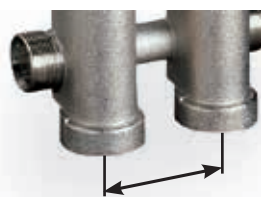

G 1" 50 mm
G 1 1/4 55 mm



38 mm

DISTRIBUZIONE

I collettori complanari sono adatti per la distribuzione dell'acqua negli impianti di riscaldamento con distribuzione orizzontale di tipo a raggiera. Infatti gli attacchi dei circuiti sono sfalsati per la mandata e il ritorno: questo permette un agevole collegamento dei circuiti senza sovrapposizione delle tubature della mandata e del ritorno.

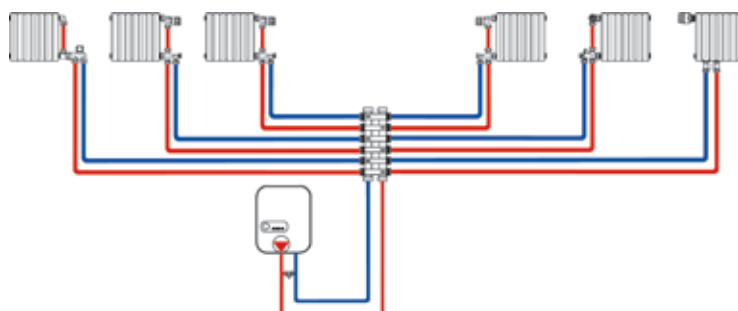

Le caratteristiche del fluido dell'impianto devono essere conformi alla direttiva UNI 8065:2019.

COLLETTORI COMPLANARI

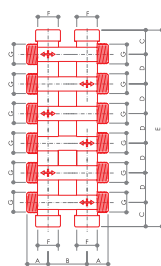
**CC 414**

Collettore complanare con attacchi laterali maschio da (W24x19).

Raccordi

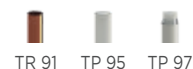

CODICE	MISURA	N. VIE	A	B	C	D	E	F	G	H	L			
68542704	G 3/4 x (W24x19)	4 + 4	27	50	26	38	166	G 3/4	W24x19	-	-	1300	1	18
68542706		6 + 6	27	50	26	38	242	G 3/4	W24x19	-	-	2030	1	12
68542708		8 + 8	27	50	26	38	318	G 3/4	W24x19	-	-	2408	1	9

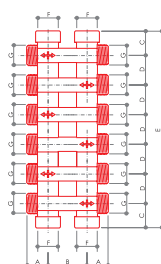
**CC 416**

Collettore complanare con attacchi laterali maschio da 3/4 eurocono.

Raccordi

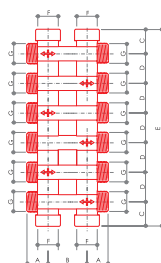

CODICE	MISURA	N. VIE	A	B	C	D	E	F	G	H	L			
68542714	G 3/4 x G 3/4 EK	4 + 4	27	50	26	38	166	G 3/4	G 3/4 EK	-	-	1300	1	18
68542716		6 + 6	27	50	26	38	242	G 3/4	G 3/4 EK	-	-	2030	1	12
68542718		8 + 8	27	50	26	38	318	G 3/4	G 3/4 EK	-	-	2408	1	9

**CC 413**

Collettore complanare con attacchi laterali maschio da (W24x19).

Raccordi

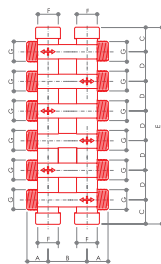

CODICE	MISURA	N. VIE	A	B	C	D	E	F	G	H	L			
68543406	G 1" x (W24x19)	6 + 6	30	55	30	38	250	G 1"	W24x19	-	-	2330	1	12
68543408		8 + 8	30	55	30	38	326	G 1"	W24x19	-	-	3248	1	9
68543410		10 + 10	30	55	30	38	402	G 1"	W24x19	-	-	4026	1	8

**CC 415**

Collettore complanare con attacchi laterali maschio da 3/4 eurocono.

Raccordi



CODICE	MISURA	N. VIE	A	B	C	D	E	F	G	H	L			
68543416	G 1" x G 3/4 EK	6 + 6	30	55	30	38	250	G 1"	G 3/4 EK	-	-	2330	1	12
68543418		8 + 8	30	55	30	38	326	G 1"	G 3/4 EK	-	-	3248	1	9
68543420		10 + 10	30	55	30	38	402	G 1"	G 3/4 EK	-	-	4026	1	8



Raccordi per tubo rame



Raccordi per tubo plastica



Raccordi per tubo multistrato



Raccordi: capitolo 7



Accessori: capitolo 2.A

DIAGRAMMA DI PORTATA COLLETTORI

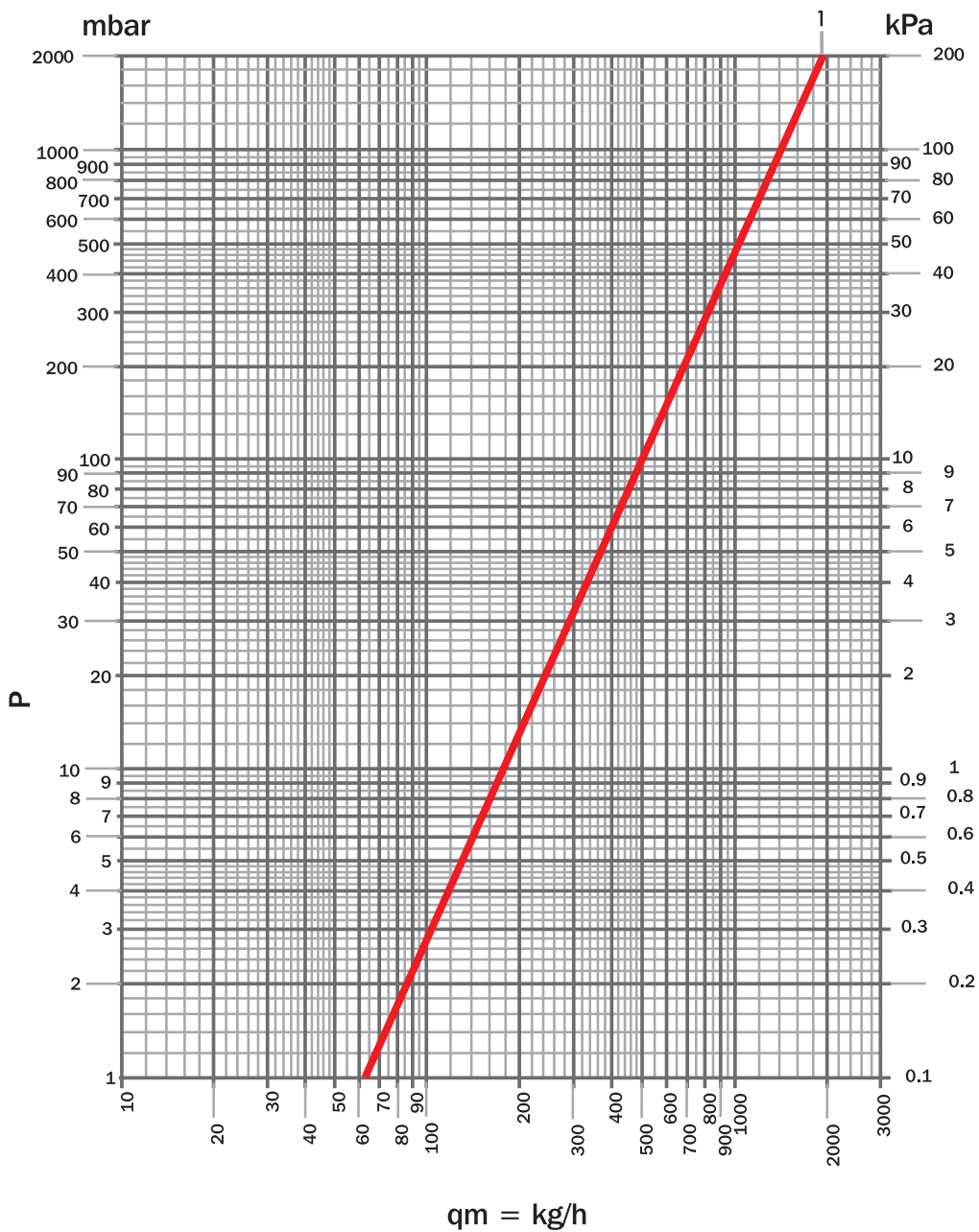

ARTICOLI	MISURA	N. VIE	Kvs	POS
CC 414 CC 416	G 3/4	4 + 4	1,96	1
		6 + 6		
		8 + 8		
CC 413 CC 415	G 1"	6 + 6		
		8 + 8		
		10 + 10		



LUXOR®

COLLETTORI DI DISTRIBUZIONE

2.4 / SERIE CD

CD

COLLETTORI DI DISTRIBUZIONE PER IMPIANTI DI RISCALDAMENTO



*Conforme secondo il D.M. 174/2004

I collettori serie CD sono ricavati da barra d'ottone trafilata con finitura gialla* o nichelata.

Tutti i collettori subiscono un trattamento di distensione del metallo al fine di eliminare eventuali tensioni causate dalla lavorazione. Sui collettori di nostra produzione utilizzare solo accessori LUXOR che abbiano una tenuta morbida con guarnizione.

Tutta la raccorderia e gli accessori dei collettori (valvole di scarico, terminali, tappi, ecc) sono dotati di tale tenuta e non necessitano di alcun elemento intermedio di sigillatura (come pfe, canapa, ecc) il cui utilizzo potrebbe causare l'insorgere di cricche.

Si consiglia di serrare la raccorderia ad una coppia massima di 60 Nm.

CARATTERISTICHE TECNICHE



Max temperatura
120 °C



Max pressione
10 bar



Materiale
CW617N
UNI EN
12165:2016



Manopola
ABS bianco
RAL 9016



Asta di comando
AISI 316



Collaudo
100%

ATTACCHI IMPIANTO

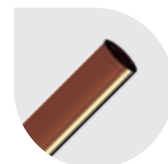

Tubo rame
W 24x19 - TR 91
G 3/4 EK - TR 91/A

CARATTERISTICHE TECNICHE CON REGOLATORI MISURATORI DI PORTATA ART. TM 4012



Max temperatura
70 °C



Max pressione
6 bar



Temperatura fluido
0 °C ÷ 100 °C



Temperatura ambiente
0 °C ÷ 60 °C



Max umidità relativa
80%

CARATTERISTICHE TECNICHE CON TESTE TERMoeLETRICHE ART. TE



Tubo plastica
W 24x19 - TP 95
G 3/4 EK - TP 98

ATTACCO CORPO PRINCIPALE

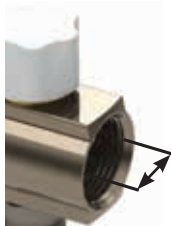

G 3/4
G 1"
G 1 1/4

INTERASSI



G 3/4 40 mm
G 1" 50 mm
G 1 1/4 50 mm



Tubo multistrato
W 24x19 - TP 97
G 3/4 EK - TP 98

REGOLATORI E MISURATORI DI PORTATA



I collettori di regolazione e bilanciamento, con regolatori e misuratori di portata TM 4012, danno la possibilità di una immediata verifica del bilanciamento dell'impianto attraverso la lettura della portata. La regolazione può essere bloccata tramite un coperchio d'arresto. Il bicchiere e la molla di misurazione possono essere smontati e puliti con l'impianto in funzione. Questo collettore deve essere installato sulla mandata.

DETTENTORI



I collettori di regolazione e bilanciamento (tipo detentore) sono dotati di regolazione micrometrica e predisposti per la memoria di posizione nel caso di chiusura momentanea e possono essere montati indifferentemente sia sulle mandate sia sui ritorni dei circuiti.



VITONE TERMOSTATIZZABILE

L'organo di tenuta sullo stelo dei collettori con valvole incorporate predisposte per la regolazione elettrotermica è ispezionabile e sostituibile anche con impianto in funzione. L'asta di comando è in acciaio inossidabile AISI 316 con una tenuta garantita da due guarnizioni o-ring in EPDM perossidico.

Tutti i collettori serie CD vengono testati al 100% con prova di tenuta pneumatica a controllo elettronico.

Le caratteristiche del fluido dell'impianto devono essere conformi alla direttiva UNI 8065:2019.

COLLETTORI DI DISTRIBUZIONE PER RISCALDAMENTO CON REGOLATORI E MISURATORI DI PORTATA IN MANDATA

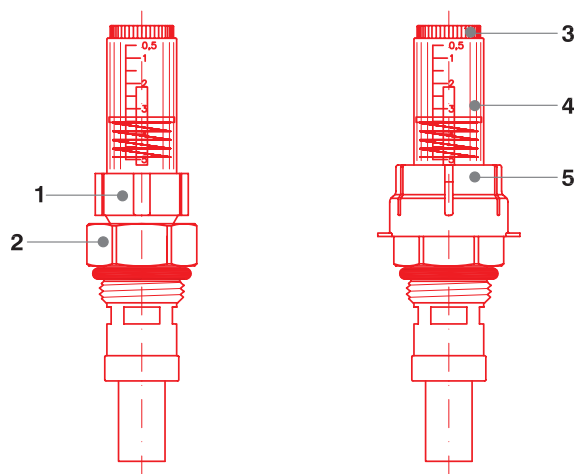

1. Ghiera di regolazione
2. Ghiera di fissaggio
3. Ghiera del bicchiere
4. Bicchiere
5. Coperchio d'arresto

ISTRUZIONI DI REGOLAZIONE COLLETTORI CON REGOLATORI MISURATORI DI PORTATA IN MANDATA

BILANCIAMENTO DEI CIRCUITI IDRAULICI

Il valore della portata teorica di un circuito idraulico, stabilito dal tecnico, è determinato dalla regolazione effettuata tramite i regolatori e misuratori di portata TM 4012 cod. 69000010 posizionati sulla mandata del circuito.

La regolazione deve avvenire con la valvola posta sul ritorno completamente aperta.

Dato che le portate di ciascun anello si influenzano tra loro, è importante che le regolazioni siano effettuate per ogni anello fino all'effettivo raggiungimento dei valori di portata in l/min stabiliti dal progetto.

PROTEZIONE DEL BILANCIAMENTO IDRAULICO CONTRO LE MANOMISSIONI

La regolazione dei regolatori misuratori di portata può essere bloccata tramite un coperchio d'arresto.

In caso di necessità, i coperchi possono essere piombati con filo di ferro e piombo.

PULIZIA

Il bicchiere e la molla di misurazione possono essere smontati per la manutenzione e puliti anche con l'impianto in funzione. Per effettuare l'operazione:

- chiudere il Top meter e il vitone posto sul collettore di ritorno
- svitare il bicchiere facendo forza sulla ghiera dello stesso e toglierlo. Attenzione a non perdere la molla di misurazione
- risulterà una leggera, ma trascurabile, perdita durante l'operazione
- il bicchiere ora può essere, se necessario, pulito senza difficoltà
- il rimontaggio si effettua invertendo le operazioni.

PERDITE DI CARICO

La perdita di carico totale per circuito di riscaldamento si compone di varie perdite di carico: valvola di ritorno, tubi e regolatore misuratore di portata.

COLLETTORI DI DISTRIBUZIONE PER RISCALDAMENTO CON DETENTORI INCORPORATI

ISTRUZIONI DI REGOLAZIONE DEI COLLETTORI CON DETENTORI

Svitare il tappo (1). Con la chiave a brugola avvitare l'otturatore fino a raggiungere la posizione di chiusura.

Dopo queste operazioni, il detentore è pronto per essere settato.

Sul diagramma di pressione differenziale è descritta la relazione tra valore di Kv, la posizione dell'otturatore e la corrispondente curva. Questo significa che, se si svita l'otturatore di un determinato numero di giri, si otterrà il Kv desiderato.

ESEMPIO

- Curva n. 1: 1/2 giri della vite - $K_v = 0,09$
- Curva n. 3: 1+1/2 giri della vite - $K_v = 0,76$

Utilizzando la ghiera (fornita a parte) cod. 3346656 è possibile creare un fine corsa meccanico all'otturatore.

Una volta impostata la portata desiderata tramite l'otturatore, la ghiera di regolazione deve essere avvitata in battuta contro l'otturatore.

Ora è possibile chiudere e riaprire l'otturatore senza perdere la posizione di regolazione impostata precedentemente.

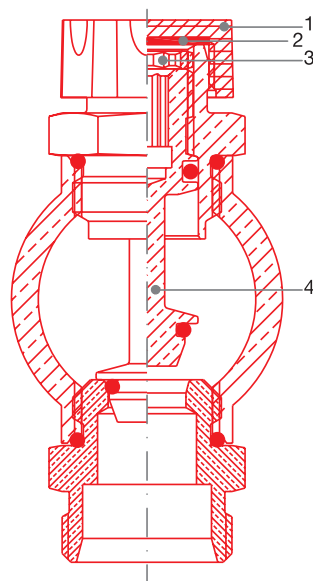

1. Tappo in ABS
2. Guarnizione di tenuta
3. Ghiera di regolazione cod. 3346656
4. Otturatore

In caso di perdite o trafiletti di acqua dall'asta del vitone termostaticizzabile, si può agire serrando l'assemblato di tenuta fino alla cessazione della stessa. Se la perdita non dovesse terminare, si può sostituire il completo assemblato di tenuta del vitone con il gruppo in funzione eseguendo le operazioni sotto elencate.

- Togliere il cappuccio di protezione o il volantino manuale, o la testa termostatica o la testa termoelettrica;
- Svitare l'assemblato di tenuta con una chiave 9 mm bloccando il corpo vitone con una chiave da 19 mm;
- Sostituire l'assemblato di tenuta con l'accessorio di ricambio cod.: 67980200 avvitandolo con una chiave 9 mm;
- Riposizionare il cappuccio di protezione o il volantino manuale o la testa termostatica o la testa termoelettrica.

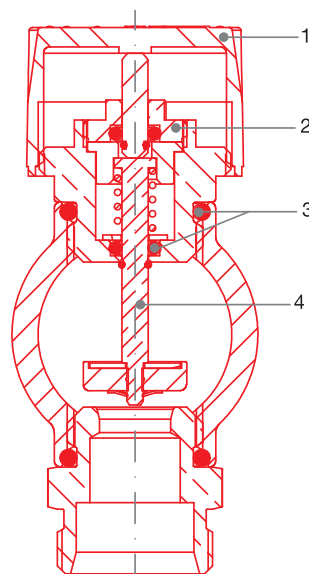

1. Tappo o volantino manuale in ABS
2. Assemblato di tenuta art.516
3. Guarnizione di tenuta
4. Otturatore

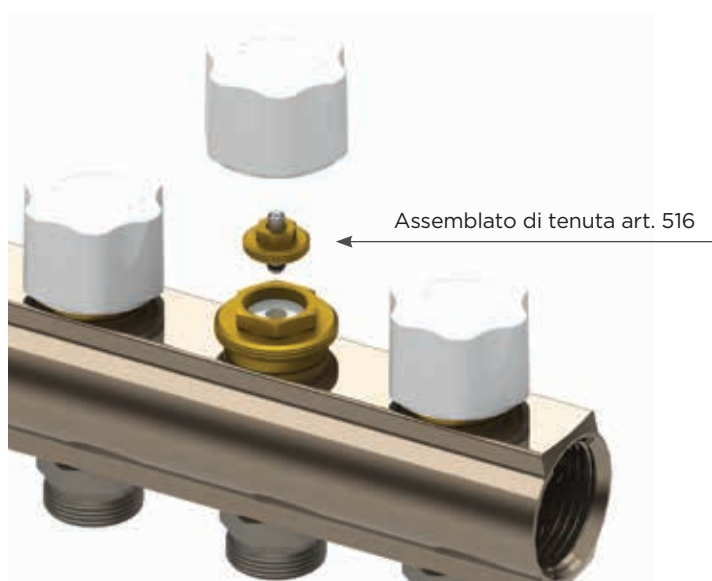

G 1"

SCHEMA PER SELEZIONARE LA CASSETTA CORRETTA

COLLETTORI DA G 1"

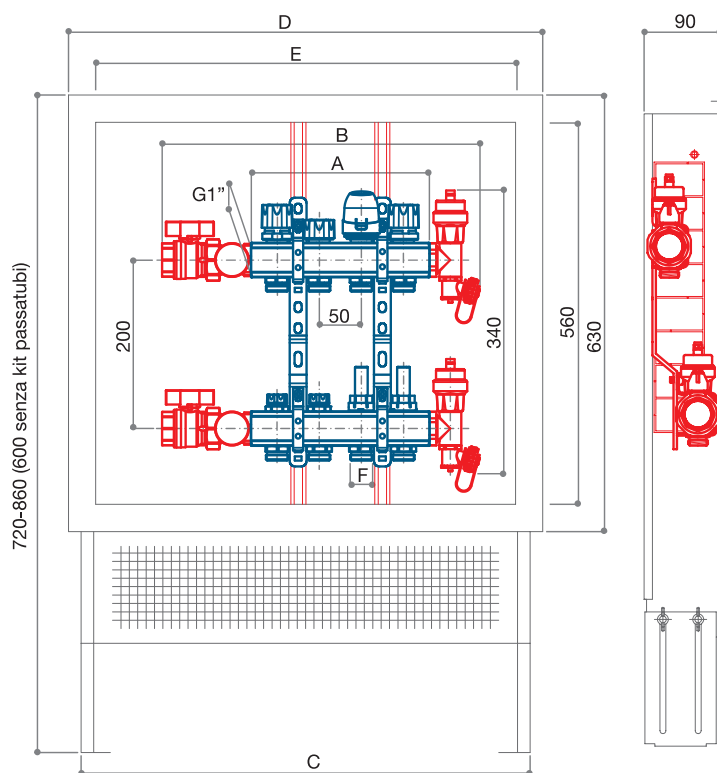

							CASSETTE	
VIE	A	B	C	D	E	F	ART.	COD.
2	112	276	500	560	490	W24x19 - G 3/4 EK	CF 490	68561405
3	162	326						
4	212	376						
5	262	426	700	760	690		CF 490	68561407
6	312	476						
7	362	526						
8	412	576	850	910	840		CF 490	68561408
9	462	626						
10	512	676						
11	562	726	1000	1060	990		CF 490	68561410
12	612	776						
13	662	826						

COLLETTORI DA G 1" CON SPURGO

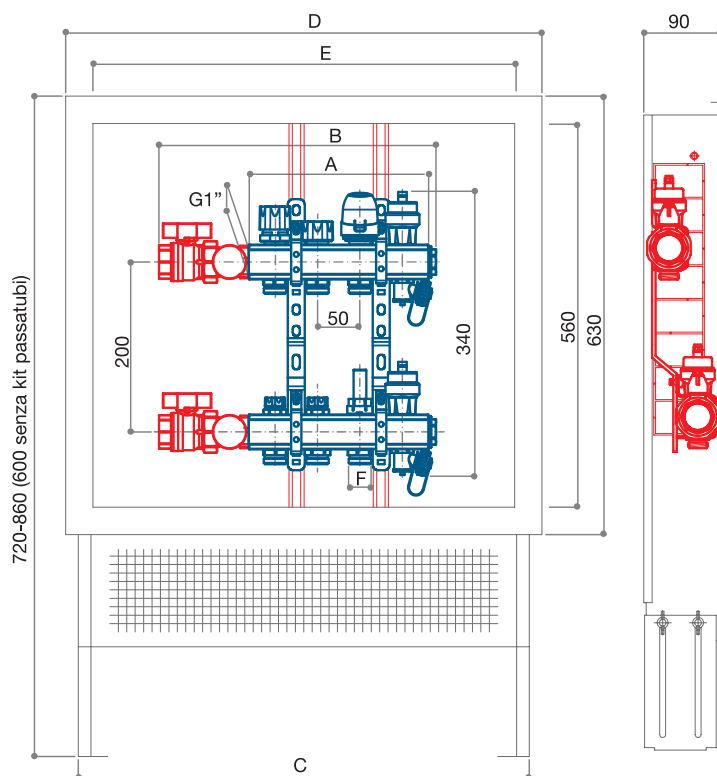

							CASSETTE	
VIE	A	B	C	D	E	F	ART.	COD.
2	162	276	500	560	490	W24x19 - G 3/4 EK	CF 490	68561405
3	212	326						
4	262	376						
5	312	426	700	760	690		CF 490	68561407
6	362	476						
7	412	526						
8	462	576	850	910	840		CF 490	68561408
9	512	626						
10	562	676						
11	612	726	1000	1060	990		CF 490	68561410
12	662	776						

G 1"1/4

SCHEMA PER SELEZIONARE LA CASSETTA CORRETTA

COLLETTORI DA G 1"1/4

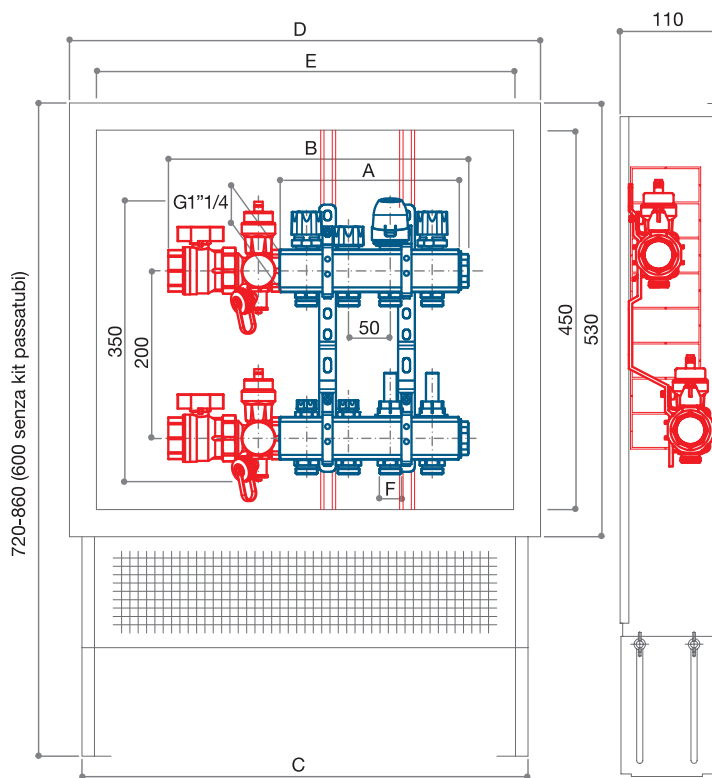

							CASSETTE	
VIE	A	B	C	D	E	F	ART.	COD.
2	114	260	500	565	490	W24x19 - G 3/4 EK	CF 485	68560705
3	164	310						
4	214	360						
5	264	410	700	765	690		CF 485	68560707
6	314	460						
7	364	510						
8	414	560	850	915	840		CF 485	68560708
9	464	610						
10	514	660						
11	564	710	1000	1065	990		CF 485	68560710
12	614	760						
13	664	810						

COLLETTORI DA G 1"1/4 CON SPURGO

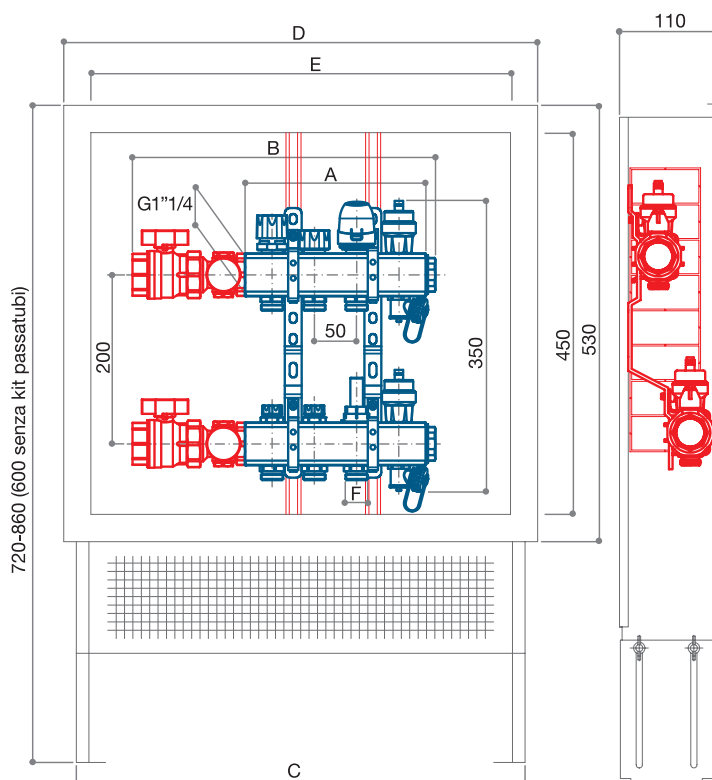





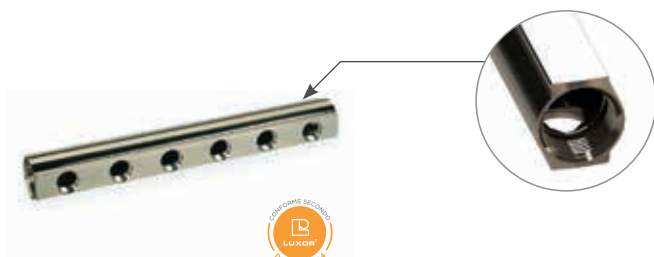

							CASSETTE	
VIE	A	B	C	D	E	F	ART.	COD.
2	164	310	500	565	490	W24x19 - G 3/4 EK	CF 485	68560705
3	214	360						
4	264	410						
5	314	460	700	765	690		CF 485	68560707
6	364	510						
7	414	560						
8	464	610	850	915	840		CF 485	68560708
9	514	660						
10	564	710						
11	614	760	1000	1065	990		CF 485	68560710
12	664	810						

COLLETTORI DI DISTRIBUZIONE PER IMPIANTI DI RISCALDAMENTO





Collettore di distribuzione.

CD 451
 Interasse
 40 mm

finitura gialla		finitura nichelata		MISURA	N. VIE						
COD.	COD.	COD.	COD.								
17012102	17012102N	17012102N	17012102N	G 3/4 x G 1/2	2	-	-	-	0,298	-	60
17012103	17012103N	17012103N	17012103N		3	-	-	-	0,448	-	40
17012104	17012104N	17012104N	17012104N		4	-	-	-	0,596	-	30
17012105	17012105N	17012105N	17012105N		5	-	-	-	0,746	-	25
17012106	17012106N	17012106N	17012106N		6	-	-	-	0,894	-	25
17012107	17012107N	17012107N	17012107N		7	-	-	-	1,044	-	20
17012108	17012108N	17012108N	17012108N		8	-	-	-	1,192	-	20
17012109	17012109N	17012109N	17012109N		9	-	-	-	1,342	-	20
17012110	17012110N	17012110N	17012110N		10	-	-	-	1,490	-	15

CD 456
 Interasse
 50 mm

finitura gialla		finitura nichelata		MISURA	N. VIE						
COD.	COD.	COD.	COD.								
15012102	15012102N	15012102N	15012102N	G 1" x G 1/2	2	-	-	-	0,420	-	50
15012103	15012103N	15012103N	15012103N		3	-	-	-	0,630	-	35
15012104	15012104N	15012104N	15012104N		4	-	-	-	0,840	-	24
15012105	15012105N	15012105N	15012105N		5	-	-	-	1,050	-	20
15012106	15012106N	15012106N	15012106N		6	-	-	-	1,260	-	18
15012107	15012107N	15012107N	15012107N		7	-	-	-	1,470	-	15
15012108	15012108N	15012108N	15012108N		8	-	-	-	1,680	-	15
15012109	15012109N	15012109N	15012109N		9	-	-	-	1,890	-	15
15012110	15012110N	15012110N	15012110N		10	-	-	-	2,100	-	15
15012111	15012111N	15012111N	15012111N		11	-	-	-	2,310	-	10
15012112	15012112N	15012112N	15012112N		12	-	-	-	2,520	-	10

CD 860
 Interasse
 50 mm

finitura gialla		finitura nichelata		MISURA	N. VIE						
COD.	COD.	COD.	COD.								
16012102	16012102N	16012102N	16012102N	G 1"1/4 x G 1/2	2	-	-	-	0,590	-	30
16012103	16012103N	16012103N	16012103N		3	-	-	-	0,866	-	20
16012104	16012104N	16012104N	16012104N		4	-	-	-	1,140	-	15
16012105	16012105N	16012105N	16012105N		5	-	-	-	1,416	-	12
16012106	16012106N	16012106N	16012106N		6	-	-	-	1,690	-	10
16012107	16012107N	16012107N	16012107N		7	-	-	-	1,966	-	10
16012108	16012108N	16012108N	16012108N		8	-	-	-	2,240	-	10
16012109	16012109N	16012109N	16012109N		9	-	-	-	2,516	-	10
16012110	16012110N	16012110N	16012110N		10	-	-	-	2,790	-	10
16012111	16012111N	16012111N	16012111N		11	-	-	-	3,066	-	5
16012112	16012112N	16012112N	16012112N		12	-	-	-	3,340	-	5



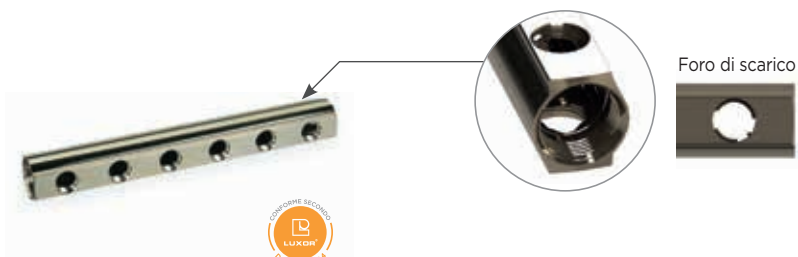

Collettore di distribuzione con foro di scarico da 1/2.

CD 457

finitura gialla		finitura nichelata		MISURA	N. VIE						
COD.	COD.	COD.	COD.								
15022102	15022102N	G 1" x G 1/2			2	-	-	-	0,420	-	50
15022103	15022103N				3	-	-	-	0,630	-	35
15022104	15022104N				4	-	-	-	0,840	-	24
15022105	15022105N				5	-	-	-	1,050	-	20
15022106	15022106N				6	-	-	-	1,260	-	18
15022107	15022107N				7	-	-	-	1,470	-	15
15022108	15022108N				8	-	-	-	1,700	-	15
15022109	15022109N				9	-	-	-	1,900	-	15
15022110	15022110N				10	-	-	-	2,110	-	15
15022111	15022111N				11	-	-	-	2,320	-	10
15022112	15022112N				12	-	-	-	2,510	-	10

CD 861





finitura gialla		finitura nichelata		MISURA	N. VIE						
COD.	COD.	COD.	COD.								
16022102	16022102N	G 1"1/4 x G 1/2			2	-	-	-	0,570	-	30
16022103	16022103N				3	-	-	-	0,860	-	20
16022104	16022104N				4	-	-	-	1,130	-	15
16022105	16022105N				5	-	-	-	1,390	-	12
16022106	16022106N				6	-	-	-	1,680	-	10
16022107	16022107N				7	-	-	-	1,940	-	10
16022108	16022108N				8	-	-	-	2,210	-	10
16022109	16022109N				9	-	-	-	2,470	-	10
16022110	16022110N				10	-	-	-	2,760	-	10
16022111	16022111N				11	-	-	-	3,040	-	5
16022112	16022112N				12	-	-	-	3,290	-	5





Collettore di distribuzione con raccordi premontati articolo RD 900.









CD 459

finitura gialla		finitura nichelata		MISURA	N. VIE						
COD.	COD.	COD.	COD.								
15032402	15032402N	15032403	15032403N	G 1" x (W24x19)	2	TR 91	TP 95	TP 97	0,496	-	30
15032403	15032403N	15032404	15032404N		3	TR 91	TP 95	TP 97	0,744	-	20
15032404	15032404N	15032405	15032405N		4	TR 91	TP 95	TP 97	0,992	-	15
15032405	15032405N	15032406	15032406N		5	TR 91	TP 95	TP 97	1,240	-	12
15032406	15032406N	15032407	15032407N		6	TR 91	TP 95	TP 97	1,488	-	12
15032407	15032407N	15032408	15032408N		7	TR 91	TP 95	TP 97	1,736	-	10
15032408	15032408N	15032409	15032409N		8	TR 91	TP 95	TP 97	1,984	-	12
15032409	15032409N	15032410	15032410N		9	TR 91	TP 95	TP 97	2,232	-	10
15032410	15032410N	15032411	15032411N		10	TR 91	TP 95	TP 97	2,480	-	10
15032411	15032411N	15032412	15032412N		11	TR 91	TP 95	TP 97	2,728	-	10
15032412	15032412N				12	TR 91	TP 95	TP 97	2,976	-	10





CD 461

finitura gialla		finitura nichelata		MISURA	N. VIE						
COD.	COD.	COD.	COD.								
15032702	15032702N	15032703	15032703N	G 1" x G 3/4 EK	2	TR 91/A	TP 98	TP 99	0,520	-	30
15032703	15032703N	15032704	15032704N		3	TR 91/A	TP 98	TP 99	0,780	-	20
15032704	15032704N	15032705	15032705N		4	TR 91/A	TP 98	TP 99	1,040	-	15
15032705	15032705N	15032706	15032706N		5	TR 91/A	TP 98	TP 99	1,300	-	12
15032706	15032706N	15032707	15032707N		6	TR 91/A	TP 98	TP 99	1,560	-	12
15032707	15032707N	15032708	15032708N		7	TR 91/A	TP 98	TP 99	1,820	-	10
15032708	15032708N	15032709	15032709N		8	TR 91/A	TP 98	TP 99	2,080	-	12
15032709	15032709N	15032710	15032710N		9	TR 91/A	TP 98	TP 99	2,340	-	10
15032710	15032710N	15032711	15032711N		10	TR 91/A	TP 98	TP 99	2,600	-	10
15032711	15032711N	15032712	15032712N		11	TR 91/A	TP 98	TP 99	2,860	-	10
15032712	15032712N				12	TR 91/A	TP 98	TP 99	3,120	-	10

CD 862

finitura gialla		finitura nichelata		MISURA	N. VIE						
COD.	COD.	COD.	COD.								
16032402	16032402N	16032403	16032403N	G 1 1/4 x (W24x19)	2	TR 91	TP 95	TP 97	0,666	-	20
16032403	16032403N	16032404	16032404N		3	TR 91	TP 95	TP 97	0,980	-	12
16032404	16032404N	16032405	16032405N		4	TR 91	TP 95	TP 97	1,292	-	10
16032405	16032405N	16032406	16032406N		5	TR 91	TP 95	TP 97	1,606	-	10
16032406	16032406N	16032407	16032407N		6	TR 91	TP 95	TP 97	1,918	-	10
16032407	16032407N	16032408	16032408N		7	TR 91	TP 95	TP 97	2,232	-	10
16032408	16032408N	16032409	16032409N		8	TR 91	TP 95	TP 97	2,544	-	8
16032409	16032409N	16032410	16032410N		9	TR 91	TP 95	TP 97	2,858	-	8
16032410	16032410N	16032411	16032411N		10	TR 91	TP 95	TP 97	3,170	-	8
16032411	16032411N	16032412	16032412N		11	TR 91	TP 95	TP 97	3,484	-	8
16032412	16032412N				12	TR 91	TP 95	TP 97	3,796	-	8

CD 864

finitura gialla		finitura nichelata		MISURA	N. VIE						
COD.	COD.	COD.	COD.								
16032702	16032702N	16032703	16032703N	G 1 1/4 x G 3/4 EK	2	TR 91/A	TP 98	TP 99	0,690	-	20
16032703	16032703N	16032704	16032704N		3	TR 91/A	TP 98	TP 99	1,019	-	12
16032704	16032704N	16032705	16032705N		4	TR 91/A	TP 98	TP 99	1,340	-	10
16032705	16032705N	16032706	16032706N		5	TR 91/A	TP 98	TP 99	1,666	-	10
16032706	16032706N	16032707	16032707N		6	TR 91/A	TP 98	TP 99	1,990	-	10
16032707	16032707N	16032708	16032708N		7	TR 91/A	TP 98	TP 99	2,316	-	10
16032708	16032708N	16032709	16032709N		8	TR 91/A	TP 98	TP 99	2,640	-	8
16032709	16032709N	16032710	16032710N		9	TR 91/A	TP 98	TP 99	2,966	-	8
16032710	16032710N	16032711	16032711N		10	TR 91/A	TP 98	TP 99	3,290	-	8
16032711	16032711N	16032712	16032712N		11	TR 91/A	TP 98	TP 99	3,616	-	8
16032712	16032712N				12	TR 91/A	TP 98	TP 99	3,940	-	8

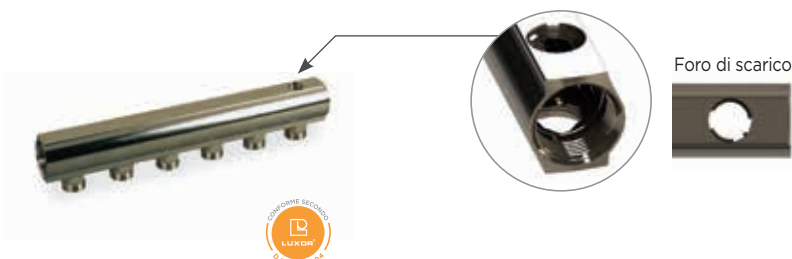

Collettore di distribuzione con foro di scarico da 1/2 e raccordi premontati articolo RD 900.

CD 460

finitura gialla		finitura nichelata		MISURA	N. VIE	TR 91	TP 95	TP 97	0,486	-	30
COD.	COD.	COD.	COD.								
15042402	15042402N	15042403	15042403N	G 1" x (W24x19)	2	TR 91	TP 95	TP 97	0,486	-	30
15042403	15042403N	15042404	15042404N		3	TR 91	TP 95	TP 97	0,734	-	20
15042404	15042404N	15042405	15042405N		4	TR 91	TP 95	TP 97	0,982	-	15
15042405	15042405N	15042406	15042406N		5	TR 91	TP 95	TP 97	1,230	-	12
15042406	15042406N	15042407	15042407N		6	TR 91	TP 95	TP 97	1,478	-	12
15042407	15042407N	15042408	15042408N		7	TR 91	TP 95	TP 97	1,726	-	10
15042408	15042408N	15042409	15042409N		8	TR 91	TP 95	TP 97	1,974	-	12
15042409	15042409N	15042410	15042410N		9	TR 91	TP 95	TP 97	2,222	-	10
15042410	15042410N	15042411	15042411N		10	TR 91	TP 95	TP 97	2,470	-	10
15042411	15042411N	15042412	15042412N		11	TR 91	TP 95	TP 97	2,718	-	10
15042412	15042412N				12	TR 91	TP 95	TP 97	2,966	-	10

CD 462

finitura gialla		finitura nichelata		MISURA	N. VIE	TR 91/A	TP 98	TP 99	0,510	-	30
COD.	COD.	COD.	COD.								
15042702	15042702N	15042703	15042703N	G 1" x G 3/4 EK	2	TR 91/A	TP 98	TP 99	0,510	-	30
15042703	15042703N	15042704	15042704N		3	TR 91/A	TP 98	TP 99	0,770	-	20
15042704	15042704N	15042705	15042705N		4	TR 91/A	TP 98	TP 99	1,030	-	15
15042705	15042705N	15042706	15042706N		5	TR 91/A	TP 98	TP 99	1,290	-	12
15042706	15042706N	15042707	15042707N		6	TR 91/A	TP 98	TP 99	1,550	-	12
15042707	15042707N	15042708	15042708N		7	TR 91/A	TP 98	TP 99	1,810	-	10
15042708	15042708N	15042709	15042709N		8	TR 91/A	TP 98	TP 99	2,070	-	12
15042709	15042709N	15042710	15042710N		9	TR 91/A	TP 98	TP 99	2,330	-	10
15042710	15042710N	15042711	15042711N		10	TR 91/A	TP 98	TP 99	2,590	-	10
15042711	15042711N	15042712	15042712N		11	TR 91/A	TP 98	TP 99	2,850	-	10
15042712	15042712N				12	TR 91/A	TP 98	TP 99	3,110	-	10

CD 863

finitura gialla		finitura nichelata		MISURA	N. VIE	TR 91	TP 95	TP 97	0,656	-	20
COD.	COD.	COD.	COD.								
16042402	16042402N	16042403	16042403N	G 1"1/4 x (W24x19)	2	TR 91	TP 95	TP 97	0,656	-	20
16042403	16042403N	16042404	16042404N		3	TR 91	TP 95	TP 97	0,970	-	12
16042404	16042404N	16042405	16042405N		4	TR 91	TP 95	TP 97	1,282	-	10
16042405	16042405N	16042406	16042406N		5	TR 91	TP 95	TP 97	1,596	-	10
16042406	16042406N	16042407	16042407N		6	TR 91	TP 95	TP 97	1,908	-	10
16042407	16042407N	16042408	16042408N		7	TR 91	TP 95	TP 97	2,222	-	10
16042408	16042408N	16042409	16042409N		8	TR 91	TP 95	TP 97	2,534	-	8
16042409	16042409N	16042410	16042410N		9	TR 91	TP 95	TP 97	2,848	-	8
16042410	16042410N	16042411	16042411N		10	TR 91	TP 95	TP 97	3,160	-	8
16042411	16042411N	16042412	16042412N		11	TR 91	TP 95	TP 97	3,474	-	8
16042412	16042412N				12	TR 91	TP 95	TP 97	3,786	-	8







CD 865

finitura gialla		finitura nichelata		MISURA	N. VIE	TR 91/A	TP 98	TP 99	0,680	-	20
COD.	COD.	COD.	COD.								
16042702	16042702N	16042703	16042703N	G 1"1/4 x G 3/4 EK	2	TR 91/A	TP 98	TP 99	0,680	-	20
16042703	16042703N	16042704	16042704N		3	TR 91/A	TP 98	TP 99	1,009	-	12
16042704	16042704N	16042705	16042705N		4	TR 91/A	TP 98	TP 99	1,330	-	10
16042705	16042705N	16042706	16042706N		5	TR 91/A	TP 98	TP 99	1,656	-	10
16042706	16042706N	16042707	16042707N		6	TR 91/A	TP 98	TP 99	1,980	-	10
16042707	16042707N	16042708	16042708N		7	TR 91/A	TP 98	TP 99	2,306	-	10
16042708	16042708N	16042709	16042709N		8	TR 91/A	TP 98	TP 99	2,630	-	8
16042709	16042709N	16042710	16042710N		9	TR 91/A	TP 98	TP 99	2,956	-	8
16042710	16042710N	16042711	16042711N		10	TR 91/A	TP 98	TP 99	3,280	-	8
16042711	16042711N	16042712	16042712N		11	TR 91/A	TP 98	TP 99	3,606	-	8
16042712	16042712N				12	TR 91/A	TP 98	TP 99	3,930	-	8









Collettore di distribuzione premontato con valvole incorporate predisposte per la regolazione elettrotermica e con cappucci di protezione.

CD 1466

finitura gialla	finitura nichelata	MISURA	N. VIE						
COD.	COD.								
15112402	15112402N	G 1" x (W24x19)	2	TR 91	TP 95	TP 97	0,644	-	20
15112403	15112403N		3	TR 91	TP 95	TP 97	0,956	-	15
15112404	15112404N		4	TR 91	TP 95	TP 97	1,268	-	12
15112405	15112405N		5	TR 91	TP 95	TP 97	1,580	-	10
15112406	15112406N		6	TR 91	TP 95	TP 97	1,892	-	9
15112407	15112407N		7	TR 91	TP 95	TP 97	2,204	-	8
15112408	15112408N		8	TR 91	TP 95	TP 97	2,516	-	8
15112409	15112409N		9	TR 91	TP 95	TP 97	2,828	-	8
15112410	15112410N		10	TR 91	TP 95	TP 97	3,140	-	8
15112411	15112411N		11	TR 91	TP 95	TP 97	3,452	-	8
15112412	15112412N		12	TR 91	TP 95	TP 97	3,764	-	8

CD 1446

finitura gialla	finitura nichelata	MISURA	N. VIE						
COD.	COD.								
15112702	15112702N	G 1" x G 3/4 EK	2	TR 91/A	TP 98	TP 99	0,664	-	20
15112703	15112703N		3	TR 91/A	TP 98	TP 99	0,986	-	15
15112704	15112704N		4	TR 91/A	TP 98	TP 99	1,308	-	12
15112705	15112705N		5	TR 91/A	TP 98	TP 99	1,630	-	10
15112706	15112706N		6	TR 91/A	TP 98	TP 99	1,952	-	10
15112707	15112707N		7	TR 91/A	TP 98	TP 99	2,274	-	8
15112708	15112708N		8	TR 91/A	TP 98	TP 99	2,596	-	8
15112709	15112709N		9	TR 91/A	TP 98	TP 99	2,918	-	8
15112710	15112710N		10	TR 91/A	TP 98	TP 99	3,240	-	8
15112711	15112711N		11	TR 91/A	TP 98	TP 99	3,562	-	8
15112712	15112712N		12	TR 91/A	TP 98	TP 99	3,884	-	8

CD 875

finitura gialla	finitura nichelata	MISURA	N. VIE						
COD.	COD.								
16112402	16112402N	G 1 1/4 x (W24x19)	2	TR 91	TP 95	TP 97	0,794	-	15
16112403	16112403N		3	TR 91	TP 95	TP 97	1,166	-	12
16112404	16112404N		4	TR 91	TP 95	TP 97	1,538	-	10
16112405	16112405N		5	TR 91	TP 95	TP 97	1,960	-	8
16112406	16112406N		6	TR 91	TP 95	TP 97	2,282	-	8
16112407	16112407N		7	TR 91	TP 95	TP 97	2,654	-	8
16112408	16112408N		8	TR 91	TP 95	TP 97	3,026	-	6
16112409	16112409N		9	TR 91	TP 95	TP 97	3,398	-	6
16112410	16112410N		10	TR 91	TP 95	TP 97	3,770	-	6
16112411	16112411N		11	TR 91	TP 95	TP 97	4,142	-	6
16112412	16112412N		12	TR 91	TP 95	TP 97	4,514	-	6

CD 876

finitura gialla	finitura nichelata	MISURA	N. VIE						
COD.	COD.								
16112702	16112702N	G 1 1/4 x G 3/4 EK	2	TR 91/A	TP 98	TP 99	0,814	-	15
16112703	16112703N		3	TR 91/A	TP 98	TP 99	1,196	-	12
16112704	16112704N		4	TR 91/A	TP 98	TP 99	1,578	-	10
16112705	16112705N		5	TR 91/A	TP 98	TP 99	1,960	-	8
16112706	16112706N		6	TR 91/A	TP 98	TP 99	2,342	-	8
16112707	16112707N		7	TR 91/A	TP 98	TP 99	2,724	-	8
16112708	16112708N		8	TR 91/A	TP 98	TP 99	3,106	-	6
16112709	16112709N		9	TR 91/A	TP 98	TP 99	3,488	-	6
16112710	16112710N		10	TR 91/A	TP 98	TP 99	3,870	-	6
16112711	16112711N		11	TR 91/A	TP 98	TP 99	4,252	-	6
16112712	16112712N		12	TR 91/A	TP 98	TP 99	4,634	-	6



Raccordi per tubo rame



Raccordi per tubo plastica



Raccordi per tubo multistrato



Raccordi: capitolo 7



Accessori: capitolo 2.A

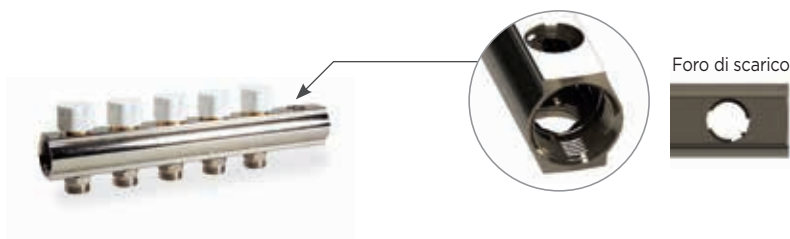

Collettore di distribuzione con 2 fori di scarico da 1/2 premontato con valvole incorporate predisposte per la regolazione elettrotermica e con cappucci di protezione.

CD 3466

finitura gialla	finitura nichelata	MISURA	N. VIE	TR 91	TP 95	TP 97	kg	m	c
COD.	COD.								
15122402	15122402N	G 1" x (W24x19)	2	TR 91	TP 95	TP 97	0,834	-	15
15122403	15122403N		3	TR 91	TP 95	TP 97	1,146	-	12
15122404	15122404N		4	TR 91	TP 95	TP 97	1,458	-	10
15122405	15122405N		5	TR 91	TP 95	TP 97	1,770	-	9
15122406	15122406N		6	TR 91	TP 95	TP 97	2,082	-	8
15122407	15122407N		7	TR 91	TP 95	TP 97	2,394	-	8
15122408	15122408N		8	TR 91	TP 95	TP 97	2,706	-	8
15122409	15122409N		9	TR 91	TP 95	TP 97	3,018	-	8
15122410	15122410N		10	TR 91	TP 95	TP 97	3,330	-	8
15122411	15122411N		11	TR 91	TP 95	TP 97	3,642	-	8
15122412	15122412N		12	TR 91	TP 95	TP 97	3,954	-	8

CD 3446

finitura gialla	finitura nichelata	MISURA	N. VIE	TR 91/A	TP 98	TP 99	kg	m	c
COD.	COD.								
15122702	15122702N	G 1" x G 3/4 EK	2	TR 91/A	TP 98	TP 99	0,854	-	15
15122703	15122703N		3	TR 91/A	TP 98	TP 99	1,176	-	12
15122704	15122704N		4	TR 91/A	TP 98	TP 99	1,498	-	10
15122705	15122705N		5	TR 91/A	TP 98	TP 99	1,820	-	9
15122706	15122706N		6	TR 91/A	TP 98	TP 99	2,142	-	8
15122707	15122707N		7	TR 91/A	TP 98	TP 99	2,464	-	8
15122708	15122708N		8	TR 91/A	TP 98	TP 99	2,786	-	8
15122709	15122709N		9	TR 91/A	TP 98	TP 99	3,108	-	8
15122710	15122710N		10	TR 91/A	TP 98	TP 99	3,430	-	8
15122711	15122711N		11	TR 91/A	TP 98	TP 99	3,752	-	8
15122712	15122712N		12	TR 91/A	TP 98	TP 99	4,074	-	8

CD 877

finitura gialla	finitura nichelata	MISURA	N. VIE	TR 91	TP 95	TP 97	kg	m	c
COD.	COD.								
16122402	16122402N	G 1"1/4 x (W24x19)	2	TR 91	TP 95	TP 97	1,044	-	12
16122403	16122403N		3	TR 91	TP 95	TP 97	1,416	-	10
16122404	16122404N		4	TR 91	TP 95	TP 97	1,788	-	8
16122405	16122405N		5	TR 91	TP 95	TP 97	2,160	-	8
16122406	16122406N		6	TR 91	TP 95	TP 97	2,532	-	6
16122407	16122407N		7	TR 91	TP 95	TP 97	2,904	-	6
16122408	16122408N		8	TR 91	TP 95	TP 97	3,276	-	6
16122409	16122409N		9	TR 91	TP 95	TP 97	3,648	-	6
16122410	16122410N		10	TR 91	TP 95	TP 97	4,020	-	6
16122411	16122411N		11	TR 91	TP 95	TP 97	4,392	-	6
16122412	16122412N		12	TR 91	TP 95	TP 97	4,764	-	6







CD 878

finitura gialla	finitura nichelata	MISURA	N. VIE	TR 91/A	TP 98	TP 99	kg	m	c
COD.	COD.								
16122702	16122702N	G 1"1/4 x G 3/4 EK	2	TR 91/A	TP 98	TP 99	1,064	-	12
16122703	16122703N		3	TR 91/A	TP 98	TP 99	1,446	-	10
16122704	16122704N		4	TR 91/A	TP 98	TP 99	1,828	-	8
16122705	16122705N		5	TR 91/A	TP 98	TP 99	2,210	-	8
16122706	16122706N		6	TR 91/A	TP 98	TP 99	2,592	-	6
16122707	16122707N		7	TR 91/A	TP 98	TP 99	2,974	-	6
16122708	16122708N		8	TR 91/A	TP 98	TP 99	3,356	-	6
16122709	16122709N		9	TR 91/A	TP 98	TP 99	3,738	-	6
16122710	16122710N		10	TR 91/A	TP 98	TP 99	4,120	-	6
16122711	16122711N		11	TR 91/A	TP 98	TP 99	4,502	-	6
16122712	16122712N		12	TR 91/A	TP 98	TP 99	4,884	-	6



Collettore di distribuzione premontato con valvole incorporate predisposte per la regolazione elettrotermica e con volantino di comando manuale.

CD 466

finitura gialla	finitura nichelata	MISURA	N. VIE						
COD.	COD.								
15152402	15152402N	G 1" x (W24x19)	2	TR 91	TP 95	TP 97	0,664	-	10
15152403	15152403N		3	TR 91	TP 95	TP 97	0,986	-	10
15152404	15152404N		4	TR 91	TP 95	TP 97	1,308	-	8
15152405	15152405N		5	TR 91	TP 95	TP 97	1,630	-	8
15152406	15152406N		6	TR 91	TP 95	TP 97	1,952	-	6
15152407	15152407N		7	TR 91	TP 95	TP 97	2,274	-	6
15152408	15152408N		8	TR 91	TP 95	TP 97	2,596	-	6
15152409	15152409N		9	TR 91	TP 95	TP 97	2,918	-	6
15152410	15152410N		10	TR 91	TP 95	TP 97	3,240	-	6
15152411	15152411N		11	TR 91	TP 95	TP 97	3,562	-	6
15152412	15152412N		12	TR 91	TP 95	TP 97	3,884	-	6

CD 446

finitura gialla	finitura nichelata	MISURA	N. VIE						
COD.	COD.								
15152702	15152702N	G 1" x G 3/4 EK	2	TR 91/A	TP 98	TP 99	0,684	-	10
15152703	15152703N		3	TR 91/A	TP 98	TP 99	1,016	-	10
15152704	15152704N		4	TR 91/A	TP 98	TP 99	1,348	-	8
15152705	15152705N		5	TR 91/A	TP 98	TP 99	1,680	-	8
15152706	15152706N		6	TR 91/A	TP 98	TP 99	2,012	-	6
15152707	15152707N		7	TR 91/A	TP 98	TP 99	2,344	-	6
15152708	15152708N		8	TR 91/A	TP 98	TP 99	2,676	-	6
15152709	15152709N		9	TR 91/A	TP 98	TP 99	3,008	-	6
15152710	15152710N		10	TR 91/A	TP 98	TP 99	3,340	-	6
15152711	15152711N		11	TR 91/A	TP 98	TP 99	3,672	-	6
15152712	15152712N		12	TR 91/A	TP 98	TP 99	4,004	-	6

CD 871

finitura gialla	finitura nichelata	MISURA	N. VIE						
COD.	COD.								
16152402	16152402N	G 1 1/4 x (W24x19)	2	TR 91	TP 95	TP 97	0,814	-	8
16152403	16152403N		3	TR 91	TP 95	TP 97	1,196	-	8
16152404	16152404N		4	TR 91	TP 95	TP 97	1,578	-	6
16152405	16152405N		5	TR 91	TP 95	TP 97	1,960	-	6
16152406	16152406N		6	TR 91	TP 95	TP 97	2,342	-	4
16152407	16152407N		7	TR 91	TP 95	TP 97	2,724	-	4
16152408	16152408N		8	TR 91	TP 95	TP 97	3,106	-	4
16152409	16152409N		9	TR 91	TP 95	TP 97	3,488	-	4
16152410	16152410N		10	TR 91	TP 95	TP 97	3,870	-	4
16152411	16152411N		11	TR 91	TP 95	TP 97	4,252	-	4
16152412	16152412N		12	TR 91	TP 95	TP 97	4,634	-	4

CD 872

finitura gialla	finitura nichelata	MISURA	N. VIE						
COD.	COD.								
16152702	16152702N	G 1 1/4 x G 3/4 EK	2	TR 91/A	TP 98	TP 99	0,834	-	8
16152703	16152703N		3	TR 91/A	TP 98	TP 99	1,226	-	8
16152704	16152704N		4	TR 91/A	TP 98	TP 99	1,618	-	6
16152705	16152705N		5	TR 91/A	TP 98	TP 99	2,010	-	6
16152706	16152706N		6	TR 91/A	TP 98	TP 99	2,402	-	4
16152707	16152707N		7	TR 91/A	TP 98	TP 99	2,794	-	4
16152708	16152708N		8	TR 91/A	TP 98	TP 99	3,186	-	4
16152709	16152709N		9	TR 91/A	TP 98	TP 99	3,578	-	4
16152710	16152710N		10	TR 91/A	TP 98	TP 99	3,970	-	4
16152711	16152711N		11	TR 91/A	TP 98	TP 99	4,362	-	4
16152712	16152712N		12	TR 91/A	TP 98	TP 99	4,754	-	4



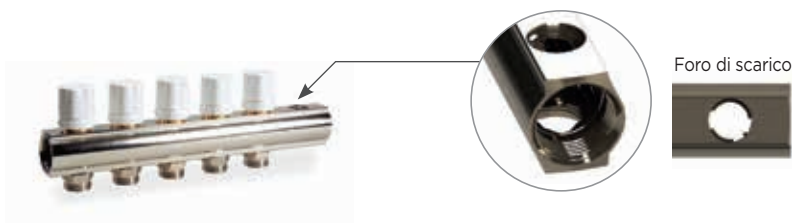

Foro di scarico

Collettore di distribuzione con 2 fori di scarico da 1/2 premontato con valvole incorporate predisposte per la regolazione elettrotermica e con volantino di comando manuale.

CD 2466

finitura gialla	finitura nichelata	MISURA	N. VIE	TR 91	TP 95	TP 97	kg	-	-
COD.	COD.								
15162402	15162402N	G 1" x (W24x19)	2	TR 91	TP 95	TP 97	0,854	-	10
15162403	15162403N		3	TR 91	TP 95	TP 97	1,176	-	8
15162404	15162404N		4	TR 91	TP 95	TP 97	1,498	-	8
15162405	15162405N		5	TR 91	TP 95	TP 97	1,820	-	6
15162406	15162406N		6	TR 91	TP 95	TP 97	2,142	-	6
15162407	15162407N		7	TR 91	TP 95	TP 97	2,464	-	6
15162408	15162408N		8	TR 91	TP 95	TP 97	2,785	-	6
15162409	15162409N		9	TR 91	TP 95	TP 97	3,108	-	6
15162410	15162410N		10	TR 91	TP 95	TP 97	3,430	-	6
15162411	15162411N		11	TR 91	TP 95	TP 97	3,752	-	6
15162412	15162412N		12	TR 91	TP 95	TP 97	4,074	-	6

CD 2446

finitura gialla	finitura nichelata	MISURA	N. VIE	TR 91/A	TP 98	TP 99	kg	-	-
COD.	COD.								
15162702	15162702N	G 1" x G 3/4 EK	2	TR 91/A	TP 98	TP 99	0,874	-	10
15162703	15162703N		3	TR 91/A	TP 98	TP 99	1,206	-	8
15162704	15162704N		4	TR 91/A	TP 98	TP 99	1,538	-	8
15162705	15162705N		5	TR 91/A	TP 98	TP 99	1,870	-	6
15162706	15162706N		6	TR 91/A	TP 98	TP 99	2,202	-	6
15162707	15162707N		7	TR 91/A	TP 98	TP 99	2,534	-	6
15162708	15162708N		8	TR 91/A	TP 98	TP 99	2,866	-	6
15162709	15162709N		9	TR 91/A	TP 98	TP 99	3,198	-	6
15162710	15162710N		10	TR 91/A	TP 98	TP 99	3,530	-	6
15162711	15162711N		11	TR 91/A	TP 98	TP 99	3,862	-	6
15162712	15162712N		12	TR 91/A	TP 98	TP 99	4,194	-	6

CD 873

finitura gialla	finitura nichelata	MISURA	N. VIE	TR 91	TP 95	TP 97	kg	-	-
COD.	COD.								
16162402	16162402N	G 1"1/4 x (W24x19)	2	TR 91	TP 95	TP 97	1,064	-	8
16162403	16162403N		3	TR 91	TP 95	TP 97	1,446	-	6
16162404	16162404N		4	TR 91	TP 95	TP 97	1,828	-	6
16162405	16162405N		5	TR 91	TP 95	TP 97	2,210	-	6
16162406	16162406N		6	TR 91	TP 95	TP 97	2,592	-	6
16162407	16162407N		7	TR 91	TP 95	TP 97	2,974	-	6
16162408	16162408N		8	TR 91	TP 95	TP 97	3,356	-	6
16162409	16162409N		9	TR 91	TP 95	TP 97	3,738	-	6
16162410	16162410N		10	TR 91	TP 95	TP 97	4,120	-	6
16162411	16162411N		11	TR 91	TP 95	TP 97	4,502	-	6
16162412	16162412N		12	TR 91	TP 95	TP 97	4,884	-	6







CD 874

finitura gialla	finitura nichelata	MISURA	N. VIE	TR 91/A	TP 98	TP 99	kg	-	-
COD.	COD.								
16162702	16162702N	G 1"1/4 x G 3/4 EK	2	TR 91/A	TP 98	TP 99	1,084	-	8
16162703	16162703N		3	TR 91/A	TP 98	TP 99	1,476	-	6
16162704	16162704N		4	TR 91/A	TP 98	TP 99	1,868	-	6
16162705	16162705N		5	TR 91/A	TP 98	TP 99	2,260	-	6
16162706	16162706N		6	TR 91/A	TP 98	TP 99	2,652	-	6
16162707	16162707N		7	TR 91/A	TP 98	TP 99	3,044	-	6
16162708	16162708N		8	TR 91/A	TP 98	TP 99	3,436	-	6
16162709	16162709N		9	TR 91/A	TP 98	TP 99	3,828	-	6
16162710	16162710N		10	TR 91/A	TP 98	TP 99	4,220	-	6
16162711	16162711N		11	TR 91/A	TP 98	TP 99	4,612	-	6
16162712	16162712N		12	TR 91/A	TP 98	TP 99	5,004	-	6









Collettore di distribuzione premontato con detentori incorporati predisposto per la doppia regolazione.



CD 449

finitura gialla	finitura nichelata	MISURA	N. VIE						
COD.	COD.								
15212402	15212402N	G 1" x (W24x19)	2	TR 91	TP 95	TP 97	0,620	-	25
15212403	15212403N		3	TR 91	TP 95	TP 97	0,920	-	20
15212404	15212404N		4	TR 91	TP 95	TP 97	1,220	-	15
15212405	15212405N		5	TR 91	TP 95	TP 97	1,520	-	15
15212406	15212406N		6	TR 91	TP 95	TP 97	1,820	-	10
15212407	15212407N		7	TR 91	TP 95	TP 97	2,120	-	10
15212408	15212408N		8	TR 91	TP 95	TP 97	2,420	-	10
15212409	15212409N		9	TR 91	TP 95	TP 97	2,720	-	10
15212410	15212410N		10	TR 91	TP 95	TP 97	3,020	-	10
15212411	15212411N		11	TR 91	TP 95	TP 97	3,320	-	10
15212412	15212412N		12	TR 91	TP 95	TP 97	3,620	-	10

CD 448

finitura gialla	finitura nichelata	MISURA	N. VIE						
COD.	COD.								
15212702	15212702N	G 1" x G 3/4 EK	2	TR 91/A	TP 98	TP 99	0,640	-	25
15212703	15212703N		3	TR 91/A	TP 98	TP 99	0,950	-	20
15212704	15212704N		4	TR 91/A	TP 98	TP 99	1,260	-	15
15212705	15212705N		5	TR 91/A	TP 98	TP 99	1,570	-	15
15212706	15212706N		6	TR 91/A	TP 98	TP 99	1,880	-	10
15212707	15212707N		7	TR 91/A	TP 98	TP 99	2,190	-	10
15212708	15212708N		8	TR 91/A	TP 98	TP 99	2,500	-	10
15212709	15212709N		9	TR 91/A	TP 98	TP 99	2,810	-	10
15212710	15212710N		10	TR 91/A	TP 98	TP 99	3,120	-	10
15212711	15212711N		11	TR 91/A	TP 98	TP 99	3,430	-	10
15212712	15212712N		12	TR 91/A	TP 98	TP 99	3,740	-	10

CD 879

finitura gialla	finitura nichelata	MISURA	N. VIE						
COD.	COD.								
16212402	16212402N	G 1 1/4 x (W24x19)	2	TR 91	TP 95	TP 97	0,770	-	15
16212403	16212403N		3	TR 91	TP 95	TP 97	1,130	-	12
16212404	16212404N		4	TR 91	TP 95	TP 97	1,490	-	10
16212405	16212405N		5	TR 91	TP 95	TP 97	1,850	-	10
16212406	16212406N		6	TR 91	TP 95	TP 97	2,210	-	8
16212407	16212407N		7	TR 91	TP 95	TP 97	2,570	-	8
16212408	16212408N		8	TR 91	TP 95	TP 97	2,930	-	8
16212409	16212409N		9	TR 91	TP 95	TP 97	3,290	-	8
16212410	16212410N		10	TR 91	TP 95	TP 97	3,650	-	8
16212411	16212411N		11	TR 91	TP 95	TP 97	4,010	-	8
16212412	16212412N		12	TR 91	TP 95	TP 97	4,370	-	8

CD 880

finitura gialla	finitura nichelata	MISURA	N. VIE						
COD.	COD.								
16212702	16212702N	G 1 1/4 x G 3/4 EK	2	TR 91/A	TP 98	TP 99	0,790	-	15
16212703	16212703N		3	TR 91/A	TP 98	TP 99	1,160	-	12
16212704	16212704N		4	TR 91/A	TP 98	TP 99	1,530	-	10
16212705	16212705N		5	TR 91/A	TP 98	TP 99	1,900	-	10
16212706	16212706N		6	TR 91/A	TP 98	TP 99	2,270	-	8
16212707	16212707N		7	TR 91/A	TP 98	TP 99	2,640	-	8
16212708	16212708N		8	TR 91/A	TP 98	TP 99	3,010	-	8
16212709	16212709N		9	TR 91/A	TP 98	TP 99	3,380	-	8
16212710	16212710N		10	TR 91/A	TP 98	TP 99	3,750	-	8
16212711	16212711N		11	TR 91/A	TP 98	TP 99	4,120	-	8
16212712	16212712N		12	TR 91/A	TP 98	TP 99	4,490	-	8



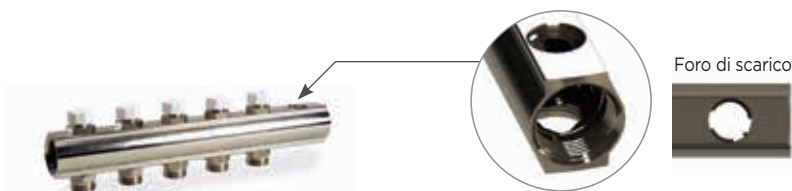

Collettore di distribuzione con 2 fori di scarico da 1/2 premontato con detentori incorporati predisposto per la doppia regolazione.

CD 1449

finitura gialla	finitura nichelata	MISURA	N. VIE	TR 91	TP 95	TP 97	kg	📦	📦
COD.	COD.								
15222402	15222402N	G 1" x (W24x19)	2	TR 91	TP 95	TP 97	0,810	-	20
15222403	15222403N		3	TR 91	TP 95	TP 97	1,110	-	15
15222404	15222404N		4	TR 91	TP 95	TP 97	1,410	-	15
15222405	15222405N		5	TR 91	TP 95	TP 97	1,710	-	10
15222406	15222406N		6	TR 91	TP 95	TP 97	2,010	-	10
15222407	15222407N		7	TR 91	TP 95	TP 97	2,310	-	10
15222408	15222408N		8	TR 91	TP 95	TP 97	2,610	-	10
15222409	15222409N		9	TR 91	TP 95	TP 97	2,910	-	10
15222410	15222410N		10	TR 91	TP 95	TP 97	3,210	-	10
15222411	15222411N		11	TR 91	TP 95	TP 97	3,510	-	10
15222412	15222412N		12	TR 91	TP 95	TP 97	3,810	-	10

CD 1448

finitura gialla	finitura nichelata	MISURA	N. VIE	TR 91/A	TP 98	TP 99	kg	📦	📦
COD.	COD.								
15222702	15222702N	G 1" x G 3/4 EK	2	TR 91/A	TP 98	TP 99	0,830	-	20
15222703	15222703N		3	TR 91/A	TP 98	TP 99	1,140	-	15
15222704	15222704N		4	TR 91/A	TP 98	TP 99	1,450	-	15
15222705	15222705N		5	TR 91/A	TP 98	TP 99	1,760	-	10
15222706	15222706N		6	TR 91/A	TP 98	TP 99	2,070	-	10
15222707	15222707N		7	TR 91/A	TP 98	TP 99	2,380	-	10
15222708	15222708N		8	TR 91/A	TP 98	TP 99	2,690	-	10
15222709	15222709N		9	TR 91/A	TP 98	TP 99	3,000	-	10
15222710	15222710N		10	TR 91/A	TP 98	TP 99	3,310	-	10
15222711	15222711N		11	TR 91/A	TP 98	TP 99	3,620	-	10
15222712	15222712N		12	TR 91/A	TP 98	TP 99	3,930	-	10

CD 881

finitura gialla	finitura nichelata	MISURA	N. VIE	TR 91	TP 95	TP 97	kg	📦	📦
COD.	COD.								
16222402	16222402N	G 1"1/4 x (W24x19)	2	TR 91	TP 95	TP 97	1,020	-	12
16222403	16222403N		3	TR 91	TP 95	TP 97	1,380	-	10
16222404	16222404N		4	TR 91	TP 95	TP 97	1,740	-	10
16222405	16222405N		5	TR 91	TP 95	TP 97	2,100	-	8
16222406	16222406N		6	TR 91	TP 95	TP 97	2,460	-	8
16222407	16222407N		7	TR 91	TP 95	TP 97	2,820	-	6
16222408	16222408N		8	TR 91	TP 95	TP 97	3,180	-	6
16222409	16222409N		9	TR 91	TP 95	TP 97	3,540	-	6
16222410	16222410N		10	TR 91	TP 95	TP 97	3,900	-	6
16222411	16222411N		11	TR 91	TP 95	TP 97	4,260	-	6
16222412	16222412N		12	TR 91	TP 95	TP 97	4,620	-	6







CD 882

finitura gialla	finitura nichelata	MISURA	N. VIE	TR 91/A	TP 98	TP 99	kg	📦	📦
COD.	COD.								
16222702	16222702N	G 1"1/4 x G 3/4 EK	2	TR 91/A	TP 98	TP 99	1,040	-	12
16222703	16222703N		3	TR 91/A	TP 98	TP 99	1,410	-	10
16222704	16222704N		4	TR 91/A	TP 98	TP 99	1,780	-	10
16222705	16222705N		5	TR 91/A	TP 98	TP 99	2,150	-	8
16222706	16222706N		6	TR 91/A	TP 98	TP 99	2,520	-	8
16222707	16222707N		7	TR 91/A	TP 98	TP 99	2,890	-	6
16222708	16222708N		8	TR 91/A	TP 98	TP 99	3,260	-	6
16222709	16222709N		9	TR 91/A	TP 98	TP 99	3,630	-	6
16222710	16222710N		10	TR 91/A	TP 98	TP 99	4,000	-	6
16222711	16222711N		11	TR 91/A	TP 98	TP 99	4,370	-	6
16222712	16222712N		12	TR 91/A	TP 98	TP 99	4,740	-	6







Collettore di distribuzione premontato
con regolatori e misuratori di portata.



CD 1474

finitura gialla	finitura nichelata	MISURA	N. VIE						
COD.	COD.								
15252402	15252402N	G 1" x (W24x19)	2	TR 91	TP 95	TP 97	0,678	-	18
15252403	15252403N		3	TR 91	TP 95	TP 97	0,992	-	12
15252404	15252404N		4	TR 91	TP 95	TP 97	1,316	-	7
15252405	15252405N		5	TR 91	TP 95	TP 97	1,680	-	7
15252406	15252406N		6	TR 91	TP 95	TP 97	1,984	-	6
15252407	15252407N		7	TR 91	TP 95	TP 97	2,308	-	5
15252408	15252408N		8	TR 91	TP 95	TP 97	2,642	-	4
15252409	15252409N		9	TR 91	TP 95	TP 97	2,956	-	4
15252410	15252410N		10	TR 91	TP 95	TP 97	3,280	-	5
15252411	15252411N		11	TR 91	TP 95	TP 97	3,604	-	5
15252412	15252412N		12	TR 91	TP 95	TP 97	3,908	-	5

CD 474

finitura gialla	finitura nichelata	MISURA	N. VIE						
COD.	COD.								
15252702	15252702N	G 1" x G 3/4 EK	2	TR 91/A	TP 98	TP 99	0,688	-	18
15252703	15252703N		3	TR 91/A	TP 98	TP 99	1,007	-	12
15252704	15252704N		4	TR 91/A	TP 98	TP 99	1,336	-	7
15252705	15252705N		5	TR 91/A	TP 98	TP 99	1,705	-	7
15252706	15252706N		6	TR 91/A	TP 98	TP 99	2,014	-	6
15252707	15252707N		7	TR 91/A	TP 98	TP 99	2,343	-	5
15252708	15252708N		8	TR 91/A	TP 98	TP 99	2,682	-	4
15252709	15252709N		9	TR 91/A	TP 98	TP 99	3,008	-	4
15252710	15252710N		10	TR 91/A	TP 98	TP 99	3,330	-	5
15252711	15252711N		11	TR 91/A	TP 98	TP 99	3,659	-	5
15252712	15252712N		12	TR 91/A	TP 98	TP 99	3,968	-	5

CD 868

finitura gialla	finitura nichelata	MISURA	N. VIE						
COD.	COD.								
16252402	16252402N	G 1 1/4 x (W24x19)	2	TR 91	TP 95	TP 97	0,854	-	14
16252403	16252403N		3	TR 91	TP 95	TP 97	1,261	-	10
16252404	16252404N		4	TR 91	TP 95	TP 97	1,658	-	6
16252405	16252405N		5	TR 91	TP 95	TP 97	2,055	-	6
16252406	16252406N		6	TR 91	TP 95	TP 97	2,462	-	5
16252407	16252407N		7	TR 91	TP 95	TP 97	2,859	-	5
16252408	16252408N		8	TR 91	TP 95	TP 97	3,236	-	4
16252409	16252409N		9	TR 91	TP 95	TP 97	3,663	-	4
16252410	16252410N		10	TR 91	TP 95	TP 97	4,060	-	5
16252411	16252411N		11	TR 91	TP 95	TP 97	4,497	-	5
16252412	16252412N		12	TR 91	TP 95	TP 97	4,874	-	5

CD 867

finitura gialla	finitura nichelata	MISURA	N. VIE						
COD.	COD.								
16252702	16252702N	G 1 1/4 x G 3/4 EK	2	TR 91/A	TP 98	TP 99	0,864	-	14
16252703	16252703N		3	TR 91/A	TP 98	TP 99	1,276	-	10
16252704	16252704N		4	TR 91/A	TP 98	TP 99	1,678	-	6
16252705	16252705N		5	TR 91/A	TP 98	TP 99	2,080	-	6
16252706	16252706N		6	TR 91/A	TP 98	TP 99	2,492	-	5
16252707	16252707N		7	TR 91/A	TP 98	TP 99	2,894	-	5
16252708	16252708N		8	TR 91/A	TP 98	TP 99	3,276	-	4
16252709	16252709N		9	TR 91/A	TP 98	TP 99	3,708	-	4
16252710	16252710N		10	TR 91/A	TP 98	TP 99	4,110	-	5
16252711	16252711N		11	TR 91/A	TP 98	TP 99	4,552	-	5
16252712	16252712N		12	TR 91/A	TP 98	TP 99	4,934	-	5



Raccordi per tubo rame



Raccordi per tubo plastica



Raccordi per tubo multistrato



Raccordi: capitolo 7



Accessori: capitolo 2.A



Foro di scarico



Collettore di distribuzione con 2 fori di scarico da 1/2 premontato con regolatori e misuratori di portata.

CD 3474

finitura gialla	finitura nichelata	MISURA	N. VIE	TR 91	TP 95	TP 97	0,858	-	12
COD.	COD.								
15262402	15262402N	G 1" x (W24x19)	2	TR 91	TP 95	TP 97	0,858	-	12
15262403	15262403N		3	TR 91	TP 95	TP 97	1,182	-	7
15262404	15262404N		4	TR 91	TP 95	TP 97	1,546	-	7
15262405	15262405N		5	TR 91	TP 95	TP 97	1,850	-	6
15262406	15262406N		6	TR 91	TP 95	TP 97	2,174	-	5
15262407	15262407N		7	TR 91	TP 95	TP 97	2,508	-	4
15262408	15262408N		8	TR 91	TP 95	TP 97	2,822	-	4
15262409	15262409N		9	TR 91	TP 95	TP 97	3,146	-	5
15262410	15262410N		10	TR 91	TP 95	TP 97	3,470	-	5
15262411	15262411N		11	TR 91	TP 95	TP 97	3,774	-	5
15262412	15262412N		12	TR 91	TP 95	TP 97	4,128	-	4

CD 2474

finitura gialla	finitura nichelata	MISURA	N. VIE	TR 91/A	TP 98	TP 99	0,868	-	12
COD.	COD.								
15262702	15262702N	G 1" x G 3/4 EK	2	TR 91/A	TP 98	TP 99	0,868	-	12
15262703	15262703N		3	TR 91/A	TP 98	TP 99	1,197	-	7
15262704	15262704N		4	TR 91/A	TP 98	TP 99	1,566	-	7
15262705	15262705N		5	TR 91/A	TP 98	TP 99	1,875	-	6
15262706	15262706N		6	TR 91/A	TP 98	TP 99	2,204	-	5
15262707	15262707N		7	TR 91/A	TP 98	TP 99	2,543	-	4
15262708	15262708N		8	TR 91/A	TP 98	TP 99	2,862	-	4
15262709	15262709N		9	TR 91/A	TP 98	TP 99	3,191	-	5
15262710	15262710N		10	TR 91/A	TP 98	TP 99	3,520	-	5
15262711	15262711N		11	TR 91/A	TP 98	TP 99	3,829	-	5
15262712	15262712N		12	TR 91/A	TP 98	TP 99	4,188	-	4

CD 870

finitura gialla	finitura nichelata	MISURA	N. VIE	TR 91	TP 95	TP 97	1,114	-	10
COD.	COD.								
16262402	16262402N	G 1"1/4 x (W24x19)	2	TR 91	TP 95	TP 97	1,114	-	10
16262403	16262403N		3	TR 91	TP 95	TP 97	1,511	-	6
16262404	16262404N		4	TR 91	TP 95	TP 97	1,908	-	6
16262405	16262405N		5	TR 91	TP 95	TP 97	2,315	-	5
16262406	16262406N		6	TR 91	TP 95	TP 97	2,712	-	5
16262407	16262407N		7	TR 91	TP 95	TP 97	3,089	-	4
16262408	16262408N		8	TR 91	TP 95	TP 97	3,516	-	4
16262409	16262409N		9	TR 91	TP 95	TP 97	3,913	-	5
16262410	16262410N		10	TR 91	TP 95	TP 97	4,350	-	5
16262411	16262411N		11	TR 91	TP 95	TP 97	4,727	-	5
16262412	16262412N		12	TR 91	TP 95	TP 97	5,104	-	4

CD 869







finitura gialla	finitura nichelata	MISURA	N. VIE	TR 91/A	TP 98	TP 99	1,124	-	10
COD.	COD.								
16262702	16262702N	G 1"1/4 x G 3/4 EK	2	TR 91/A	TP 98	TP 99	1,124	-	10
16262703	16262703N		3	TR 91/A	TP 98	TP 99	1,526	-	6
16262704	16262704N		4	TR 91/A	TP 98	TP 99	1,928	-	6
16262705	16262705N		5	TR 91/A	TP 98	TP 99	2,340	-	5
16262706	16262706N		6	TR 91/A	TP 98	TP 99	2,742	-	5
16262707	16262707N		7	TR 91/A	TP 98	TP 99	3,124	-	4
16262708	16262708N		8	TR 91/A	TP 98	TP 99	3,556	-	4
16262709	16262709N		9	TR 91/A	TP 98	TP 99	3,958	-	5
16262710	16262710N		10	TR 91/A	TP 98	TP 99	4,400	-	5
16262711	16262711N		11	TR 91/A	TP 98	TP 99	4,782	-	5
16262712	16262712N		12	TR 91/A	TP 98	TP 99	5,164	-	4









Collettore di distribuzione premontato con vitone manuale con dischetti in alluminio per indicazioni utenze.



CD 101

finitura gialla		finitura nichelata		MISURA	N. VIE						
COD.	COD.	COD.	COD.								
15312402	15312402N	G 1" x (W24x19)		2	TR 91	TP 95	TP 97	0,642	-	24	
15312403	15312403N			3	TR 91	TP 95	TP 97	0,933	-	18	
15312404	15312404N			4	TR 91	TP 95	TP 97	1,244	-	12	
15312405	15312405N			5	TR 91	TP 95	TP 97	1,555	-	10	
15312406	15312406N			6	TR 91	TP 95	TP 97	1,866	-	9	
15312407	15312407N			7	TR 91	TP 95	TP 97	2,177	-	8	
15312408	15312408N			8	TR 91	TP 95	TP 97	2,468	-	8	
15312409	15312409N			9	TR 91	TP 95	TP 97	2,809	-	8	
15312410	15312410N			10	TR 91	TP 95	TP 97	3,090	-	8	
15312411	15312411N			11	TR 91	TP 95	TP 97	3,401	-	8	
15312412	15312412N			12	TR 91	TP 95	TP 97	3,692	-	8	

CD 100

finitura gialla		finitura nichelata		MISURA	N. VIE						
COD.	COD.	COD.	COD.								
15312702	15312702N	G 1" x G 3/4 EK		2	TR 91/A	TP 98	TP 99	0,660	-	24	
15312703	15312703N			3	TR 91/A	TP 98	TP 99	0,960	-	18	
15312704	15312704N			4	TR 91/A	TP 98	TP 99	1,280	-	12	
15312705	15312705N			5	TR 91/A	TP 98	TP 99	1,600	-	10	
15312706	15312706N			6	TR 91/A	TP 98	TP 99	1,920	-	9	
15312707	15312707N			7	TR 91/A	TP 98	TP 99	2,240	-	8	
15312708	15312708N			8	TR 91/A	TP 98	TP 99	2,540	-	8	
15312709	15312709N			9	TR 91/A	TP 98	TP 99	2,890	-	8	
15312710	15312710N			10	TR 91/A	TP 98	TP 99	3,180	-	8	
15312711	15312711N			11	TR 91/A	TP 98	TP 99	3,500	-	8	
15312712	15312712N			12	TR 91/A	TP 98	TP 99	3,800	-	8	





Collettore di distribuzione composto da:
 • 2 collettori con raccordi premontati RD900
 • 2 supporti metallici.



CD 3459

finitura gialla		finitura nichelata		MISURA	N. VIE	TR 91	TP 95	TP 97	1,512	1	-
COD.	COD.	COD.	COD.								
15412402	15412402N			G 1" x (W24x19)	2	TR 91	TP 95	TP 97	1,512	1	-
15412403	15412403N				3	TR 91	TP 95	TP 97	2,008	1	-
15412404	15412404N				4	TR 91	TP 95	TP 97	2,504	1	-
15412405	15412405N				5	TR 91	TP 95	TP 97	3,000	1	-
15412406	15412406N				6	TR 91	TP 95	TP 97	3,496	1	-
15412407	15412407N				7	TR 91	TP 95	TP 97	3,992	1	-
15412408	15412408N				8	TR 91	TP 95	TP 97	4,488	1	-
15412409	15412409N				9	TR 91	TP 95	TP 97	4,984	1	-
15412410	15412410N				10	TR 91	TP 95	TP 97	5,480	1	-
15412411	15412411N				11	TR 91	TP 95	TP 97	5,976	1	-
15412412	15412412N				12	TR 91	TP 95	TP 97	6,472	1	-

CD 3461

finitura gialla		finitura nichelata		MISURA	N. VIE	TR 91/A	TP 98	TP 99	1,560	1	-
COD.	COD.	COD.	COD.								
15412702	15412702N			G 1" x G 3/4 EK	2	TR 91/A	TP 98	TP 99	1,560	1	-
15412703	15412703N				3	TR 91/A	TP 98	TP 99	2,080	1	-
15412704	15412704N				4	TR 91/A	TP 98	TP 99	2,600	1	-
15412705	15412705N				5	TR 91/A	TP 98	TP 99	3,130	1	-
15412706	15412706N				6	TR 91/A	TP 98	TP 99	3,640	1	-
15412707	15412707N				7	TR 91/A	TP 98	TP 99	4,160	1	-
15412708	15412708N				8	TR 91/A	TP 98	TP 99	4,680	1	-
15412709	15412709N				9	TR 91/A	TP 98	TP 99	5,200	1	-
15412710	15412710N				10	TR 91/A	TP 98	TP 99	5,720	1	-
15412711	15412711N				11	TR 91/A	TP 98	TP 99	6,240	1	-
15412712	15412712N				12	TR 91/A	TP 98	TP 99	6,760	1	-

CD 3862

finitura gialla		finitura nichelata		MISURA	N. VIE	TR 91	TP 95	TP 97	1,912	1	-
COD.	COD.	COD.	COD.								
16412402	16412402N			G 1"1/4 x (W24x19)	2	TR 91	TP 95	TP 97	1,912	1	-
16412403	16412403N				3	TR 91	TP 95	TP 97	2,540	1	-
16412404	16412404N				4	TR 91	TP 95	TP 97	3,164	1	-
16412405	16412405N				5	TR 91	TP 95	TP 97	3,792	1	-
16412406	16412406N				6	TR 91	TP 95	TP 97	4,416	1	-
16412407	16412407N				7	TR 91	TP 95	TP 97	5,044	1	-
16412408	16412408N				8	TR 91	TP 95	TP 97	5,680	1	-
16412409	16412409N				9	TR 91	TP 95	TP 97	6,296	1	-
16412410	16412410N				10	TR 91	TP 95	TP 97	6,920	1	-
16412411	16412411N				11	TR 91	TP 95	TP 97	7,548	1	-
16412412	16412412N				12	TR 91	TP 95	TP 97	8,172	1	-

CD 3864



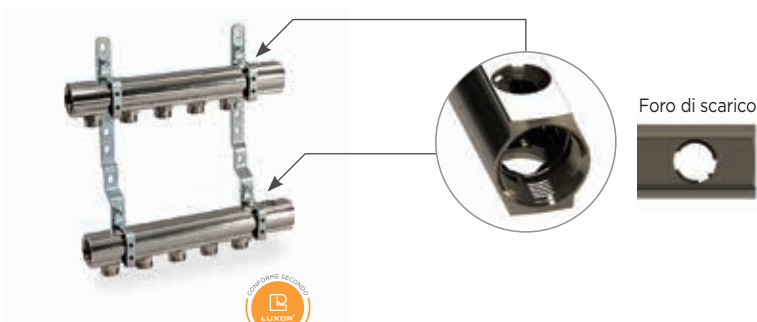



finitura gialla		finitura nichelata		MISURA	N. VIE	TR 91/A	TP 98	TP 99	1,960	1	-
COD.	COD.	COD.	COD.								
16412702	16412702N			G 1"1/4 x G 3/4 EK	2	TR 91/A	TP 98	TP 99	1,960	1	-
16412703	16412703N				3	TR 91/A	TP 98	TP 99	2,618	1	-
16412704	16412704N				4	TR 91/A	TP 98	TP 99	3,260	1	-
16412705	16412705N				5	TR 91/A	TP 98	TP 99	3,912	1	-
16412706	16412706N				6	TR 91/A	TP 98	TP 99	4,560	1	-
16412707	16412707N				7	TR 91/A	TP 98	TP 99	5,212	1	-
16412708	16412708N				8	TR 91/A	TP 98	TP 99	5,860	1	-
16412709	16412709N				9	TR 91/A	TP 98	TP 99	6,512	1	-
16412710	16412710N				10	TR 91/A	TP 98	TP 99	7,160	1	-
16412711	16412711N				11	TR 91/A	TP 98	TP 99	7,812	1	-
16412712	16412712N				12	TR 91/A	TP 98	TP 99	8,460	1	-









Collettore di distribuzione con 2 fori di scarico da 1/2 composto da:

- 2 collettori con raccordi premontati RD900
- 2 supporti metallici.



CD 3460

finitura gialla		finitura nichelata		MISURA	N. VIE						
COD.	COD.	COD.	COD.								
15422402	15422402N	G 1" x (W24x19)		2	TR 91	TP 95	TP 97	1,450	1	-	
15422403	15422403N			3	TR 91	TP 95	TP 97	1,946	1	-	
15422404	15422404N			4	TR 91	TP 95	TP 97	2,442	1	-	
15422405	15422405N			5	TR 91	TP 95	TP 97	2,938	1	-	
15422406	15422406N			6	TR 91	TP 95	TP 97	3,434	1	-	
15422407	15422407N			7	TR 91	TP 95	TP 97	3,930	1	-	
15422408	15422408N			8	TR 91	TP 95	TP 97	4,426	1	-	
15422409	15422409N			9	TR 91	TP 95	TP 97	4,922	1	-	
15422410	15422410N			10	TR 91	TP 95	TP 97	5,418	1	-	
15422411	15422411N			11	TR 91	TP 95	TP 97	5,914	1	-	
15422412	15422412N			12	TR 91	TP 95	TP 97	6,410	1	-	

CD 3462

finitura gialla		finitura nichelata		MISURA	N. VIE						
COD.	COD.	COD.	COD.								
15422702	15422702N	G 1" x G 3/4 EK		2	TR 91/A	TP 98	TP 99	1,489	1	-	
15422703	15422703N			3	TR 91/A	TP 98	TP 99	2,009	1	-	
15422704	15422704N			4	TR 91/A	TP 98	TP 99	2,529	1	-	
15422705	15422705N			5	TR 91/A	TP 98	TP 99	3,049	1	-	
15422706	15422706N			6	TR 91/A	TP 98	TP 99	3,569	1	-	
15422707	15422707N			7	TR 91/A	TP 98	TP 99	4,089	1	-	
15422708	15422708N			8	TR 91/A	TP 98	TP 99	4,609	1	-	
15422709	15422709N			9	TR 91/A	TP 98	TP 99	5,129	1	-	
15422710	15422710N			10	TR 91/A	TP 98	TP 99	5,649	1	-	
15422711	15422711N			11	TR 91/A	TP 98	TP 99	6,169	1	-	
15422712	15422712N			12	TR 91/A	TP 98	TP 99	6,689	1	-	

CD 3863

finitura gialla		finitura nichelata		MISURA	N. VIE						
COD.	COD.	COD.	COD.								
16422402	16422402N	G 1 1/4 x (W24x19)		2	TR 91	TP 95	TP 97	1,850	1	-	
16422403	16422403N			3	TR 91	TP 95	TP 97	2,478	1	-	
16422404	16422404N			4	TR 91	TP 95	TP 97	3,102	1	-	
16422405	16422405N			5	TR 91	TP 95	TP 97	3,730	1	-	
16422406	16422406N			6	TR 91	TP 95	TP 97	4,354	1	-	
16422407	16422407N			7	TR 91	TP 95	TP 97	4,982	1	-	
16422408	16422408N			8	TR 91	TP 95	TP 97	5,606	1	-	
16422409	16422409N			9	TR 91	TP 95	TP 97	6,234	1	-	
16422410	16422410N			10	TR 91	TP 95	TP 97	6,858	1	-	
16422411	16422411N			11	TR 91	TP 95	TP 97	7,486	1	-	
16422412	16422412N			12	TR 91	TP 95	TP 97	8,110	1	-	

CD 3865

finitura gialla		finitura nichelata		MISURA	N. VIE						
COD.	COD.	COD.	COD.								
16422702	16422702N	G 1 1/4 x G 3/4 EK		2	TR 91/A	TP 98	TP 99	1,889	1	-	
16422703	16422703N			3	TR 91/A	TP 98	TP 99	2,547	1	-	
16422704	16422704N			4	TR 91/A	TP 98	TP 99	3,189	1	-	
16422705	16422705N			5	TR 91/A	TP 98	TP 99	3,841	1	-	
16422706	16422706N			6	TR 91/A	TP 98	TP 99	4,489	1	-	
16422707	16422707N			7	TR 91/A	TP 98	TP 99	5,141	1	-	
16422708	16422708N			8	TR 91/A	TP 98	TP 99	5,789	1	-	
16422709	16422709N			9	TR 91/A	TP 98	TP 99	6,441	1	-	
16422710	16422710N			10	TR 91/A	TP 98	TP 99	7,089	1	-	
16422711	16422711N			11	TR 91/A	TP 98	TP 99	7,741	1	-	
16422712	16422712N			12	TR 91/A	TP 98	TP 99	8,389	1	-	



Collettore di distribuzione composto da:

- 1 collettore di ritorno con valvole incorporate predisposte per la regolazione elettrotermica e con cappucci di protezione
- 1 collettore di andata con detentori incorporati predisposto per la doppia regolazione
- 2 supporti metallici.

CD 2465

finitura gialla	finitura nichelata	MISURA	N. VIE						
COD.	COD.								
15512402	15512402N	G 1" x (W24x19)	2	TR 91	TP 95	TP 97	1,830	1	-
15512403	15512403N		3	TR 91	TP 95	TP 97	2,442	1	-
15512404	15512404N		4	TR 91	TP 95	TP 97	3,053	1	-
15512405	15512405N		5	TR 91	TP 95	TP 97	3,665	1	-
15512406	15512406N		6	TR 91	TP 95	TP 97	4,278	1	-
15512407	15512407N		7	TR 91	TP 95	TP 97	4,890	1	-
15512408	15512408N		8	TR 91	TP 95	TP 97	5,502	1	-
15512409	15512409N		9	TR 91	TP 95	TP 97	6,114	1	-
15512410	15512410N		10	TR 91	TP 95	TP 97	6,726	1	-
15512411	15512411N		11	TR 91	TP 95	TP 97	7,338	1	-
15512412	15512412N		12	TR 91	TP 95	TP 97	7,950	1	-
15512413	15512413N		13	TR 91	TP 95	TP 97	8,562	1	-

CD 2468

finitura gialla	finitura nichelata	MISURA	N. VIE						
COD.	COD.								
15512702	15512702N	G 1" x G 3/4 EK	2	TR 91/A	TP 98	TP 99	1,870	1	-
15512703	15512703N		3	TR 91/A	TP 98	TP 99	2,502	1	-
15512704	15512704N		4	TR 91/A	TP 98	TP 99	3,134	1	-
15512705	15512705N		5	TR 91/A	TP 98	TP 99	3,766	1	-
15512706	15512706N		6	TR 91/A	TP 98	TP 99	4,398	1	-
15512707	15512707N		7	TR 91/A	TP 98	TP 99	5,030	1	-
15512708	15512708N		8	TR 91/A	TP 98	TP 99	5,662	1	-
15512709	15512709N		9	TR 91/A	TP 98	TP 99	6,294	1	-
15512710	15512710N		10	TR 91/A	TP 98	TP 99	6,926	1	-
15512711	15512711N		11	TR 91/A	TP 98	TP 99	7,558	1	-
15512712	15512712N		12	TR 91/A	TP 98	TP 99	8,190	1	-
15512713	15512713N		13	TR 91/A	TP 98	TP 99	8,822	1	-

CD 2865

finitura gialla	finitura nichelata	MISURA	N. VIE						
COD.	COD.								
16512402	16512402N	G 1 1/4 x (W24x19)	2	TR 91	TP 95	TP 97	2,174	1	-
16512403	16512403N		3	TR 91	TP 95	TP 97	2,906	1	-
16512404	16512404N		4	TR 91	TP 95	TP 97	3,638	1	-
16512405	16512405N		5	TR 91	TP 95	TP 97	4,370	1	-
16512406	16512406N		6	TR 91	TP 95	TP 97	5,102	1	-
16512407	16512407N		7	TR 91	TP 95	TP 97	5,834	1	-
16512408	16512408N		8	TR 91	TP 95	TP 97	6,566	1	-
16512409	16512409N		9	TR 91	TP 95	TP 97	7,298	1	-
16512410	16512410N		10	TR 91	TP 95	TP 97	8,030	1	-
16512411	16512411N		11	TR 91	TP 95	TP 97	8,762	1	-
16512412	16512412N		12	TR 91	TP 95	TP 97	9,494	1	-
16512413	16512413N		13	TR 91	TP 95	TP 97	10,226	1	-

CD 2868

finitura gialla	finitura nichelata	MISURA	N. VIE						
COD.	COD.								
16512702	16512702N	G 1 1/4 x G 3/4 EK	2	TR 91/A	TP 98	TP 99	2,214	1	-
16512703	16512703N		3	TR 91/A	TP 98	TP 99	2,966	1	-
16512704	16512704N		4	TR 91/A	TP 98	TP 99	3,718	1	-
16512705	16512705N		5	TR 91/A	TP 98	TP 99	4,470	1	-
16512706	16512706N		6	TR 91/A	TP 98	TP 99	5,222	1	-
16512707	16512707N		7	TR 91/A	TP 98	TP 99	5,974	1	-
16512708	16512708N		8	TR 91/A	TP 98	TP 99	6,726	1	-
16512709	16512709N		9	TR 91/A	TP 98	TP 99	7,478	1	-
16512710	16512710N		10	TR 91/A	TP 98	TP 99	8,230	1	-
16512711	16512711N		11	TR 91/A	TP 98	TP 99	8,982	1	-
16512712	16512712N		12	TR 91/A	TP 98	TP 99	9,734	1	-
16512713	16512713N		13	TR 91/A	TP 98	TP 99	10,486	1	-



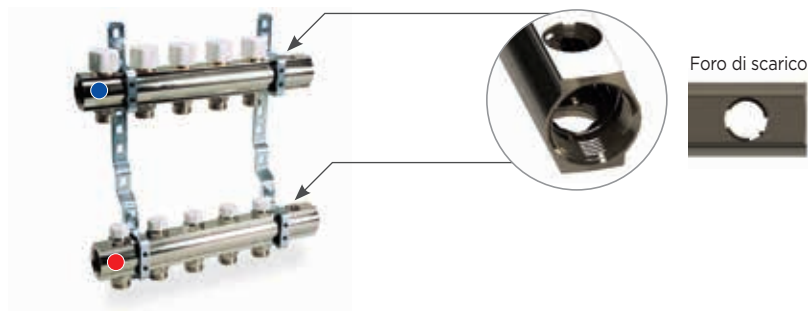







Collettore di distribuzione con 2 fori di scarico da 1/2 premontato composto da:

- 1 collettore di ritorno con valvole incorporate predisposte per la regolazione elettrotermica e con cappucci di protezione
- 1 collettore di andata con detentori incorporati predisposto per la doppia regolazione
- 2 supporti metallici.

CD 2467

finitura gialla	finitura nichelata	MISURA	N. VIE						
COD.	COD.								
15522402	15522402N	G 1" x (W24x19)	2	TR 91	TP 95	TP 97	2,210	1	-
15522403	15522403N		3	TR 91	TP 95	TP 97	2,822	1	-
15522404	15522404N		4	TR 91	TP 95	TP 97	3,434	1	-
15522405	15522405N		5	TR 91	TP 95	TP 97	4,046	1	-
15522406	15522406N		6	TR 91	TP 95	TP 97	4,658	1	-
15522407	15522407N		7	TR 91	TP 95	TP 97	5,270	1	-
15522408	15522408N		8	TR 91	TP 95	TP 97	5,882	1	-
15522409	15522409N		9	TR 91	TP 95	TP 97	6,494	1	-
15522410	15522410N		10	TR 91	TP 95	TP 97	7,106	1	-
15522411	15522411N		11	TR 91	TP 95	TP 97	7,718	1	-
15522412	15522412N		12	TR 91	TP 95	TP 97	8,330	1	-

CD 2469

finitura gialla	finitura nichelata	MISURA	N. VIE						
COD.	COD.								
15522702	15522702N	G 1" x G 3/4 EK	2	TR 91/A	TP 98	TP 99	2,250	1	-
15522703	15522703N		3	TR 91/A	TP 98	TP 99	2,882	1	-
15522704	15522704N		4	TR 91/A	TP 98	TP 99	3,514	1	-
15522705	15522705N		5	TR 91/A	TP 98	TP 99	4,146	1	-
15522706	15522706N		6	TR 91/A	TP 98	TP 99	4,778	1	-
15522707	15522707N		7	TR 91/A	TP 98	TP 99	5,410	1	-
15522708	15522708N		8	TR 91/A	TP 98	TP 99	6,042	1	-
15522709	15522709N		9	TR 91/A	TP 98	TP 99	6,674	1	-
15522710	15522710N		10	TR 91/A	TP 98	TP 99	7,306	1	-
15522711	15522711N		11	TR 91/A	TP 98	TP 99	7,938	1	-
15522712	15522712N		12	TR 91/A	TP 98	TP 99	8,570	1	-

CD 2867

finitura gialla	finitura nichelata	MISURA	N. VIE						
COD.	COD.								
16522402	16522402N	G 1 1/4 x (W24x19)	2	TR 91	TP 95	TP 97	2,674	1	-
16522403	16522403N		3	TR 91	TP 95	TP 97	3,406	1	-
16522404	16522404N		4	TR 91	TP 95	TP 97	4,138	1	-
16522405	16522405N		5	TR 91	TP 95	TP 97	4,870	1	-
16522406	16522406N		6	TR 91	TP 95	TP 97	5,602	1	-
16522407	16522407N		7	TR 91	TP 95	TP 97	6,334	1	-
16522408	16522408N		8	TR 91	TP 95	TP 97	7,066	1	-
16522409	16522409N		9	TR 91	TP 95	TP 97	7,798	1	-
16522410	16522410N		10	TR 91	TP 95	TP 97	8,530	1	-
16522411	16522411N		11	TR 91	TP 95	TP 97	9,262	1	-
16522412	16522412N		12	TR 91	TP 95	TP 97	9,994	1	-

CD 2869

finitura gialla	finitura nichelata	MISURA	N. VIE						
COD.	COD.								
16522702	16522702N	G 1 1/4 x G 3/4 EK	2	TR 91/A	TP 98	TP 99	2,714	1	-
16522703	16522703N		3	TR 91/A	TP 98	TP 99	3,466	1	-
16522704	16522704N		4	TR 91/A	TP 98	TP 99	4,218	1	-
16522705	16522705N		5	TR 91/A	TP 98	TP 99	4,970	1	-
16522706	16522706N		6	TR 91/A	TP 98	TP 99	5,722	1	-
16522707	16522707N		7	TR 91/A	TP 98	TP 99	6,474	1	-
16522708	16522708N		8	TR 91/A	TP 98	TP 99	7,226	1	-
16522709	16522709N		9	TR 91/A	TP 98	TP 99	7,978	1	-
16522710	16522710N		10	TR 91/A	TP 98	TP 99	8,730	1	-
16522711	16522711N		11	TR 91/A	TP 98	TP 99	9,482	1	-
16522712	16522712N		12	TR 91/A	TP 98	TP 99	10,234	1	-



Raccordi per tubo rame



Raccordi per tubo plastica



Raccordi per tubo multistrato



Raccordi: capitolo 7





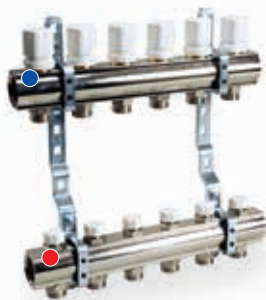



Accessori: capitolo 2.A





Collettore di distribuzione premontato composto da:

- 1 collettore di ritorno con valvole incorporate predisposte per la regolazione elettrotermica e con volantino di comando manuale
- 1 collettore di andata con detentori incorporati predisposto per la doppia regolazione
- 2 supporti metallici.





CD 465

finitura gialla	finitura nichelata	MISURA	N. VIE							
COD.	COD.									
15552402	15552402N	G 1" x (W24x19)	2	TR 91	TP 95	TP 97	1,850	1	-	
15552403	15552403N		3	TR 91	TP 95	TP 97	2,472	1	-	
15552404	15552404N		4	TR 91	TP 95	TP 97	3,094	1	-	
15552405	15552405N		5	TR 91	TP 95	TP 97	3,716	1	-	
15552406	15552406N		6	TR 91	TP 95	TP 97	4,338	1	-	
15552407	15552407N		7	TR 91	TP 95	TP 97	4,960	1	-	
15552408	15552408N		8	TR 91	TP 95	TP 97	5,582	1	-	
15552409	15552409N		9	TR 91	TP 95	TP 97	6,204	1	-	
15552410	15552410N		10	TR 91	TP 95	TP 97	6,826	1	-	
15552411	15552411N		11	TR 91	TP 95	TP 97	7,448	1	-	
15552412	15552412N		12	TR 91	TP 95	TP 97	8,070	1	-	
15552413	15552413N		13	TR 91	TP 95	TP 97	8,692	1	-	



CD 468

finitura gialla	finitura nichelata	MISURA	N. VIE							
COD.	COD.									
15552702	15552702N	G 1" x G 3/4 EK	2	TR 91/A	TP 98	TP 99	1,890	1	-	
15552703	15552703N		3	TR 91/A	TP 98	TP 99	2,532	1	-	
15552704	15552704N		4	TR 91/A	TP 98	TP 99	3,174	1	-	
15552705	15552705N		5	TR 91/A	TP 98	TP 99	3,816	1	-	
15552706	15552706N		6	TR 91/A	TP 98	TP 99	4,458	1	-	
15552707	15552707N		7	TR 91/A	TP 98	TP 99	5,100	1	-	
15552708	15552708N		8	TR 91/A	TP 98	TP 99	5,742	1	-	
15552709	15552709N		9	TR 91/A	TP 98	TP 99	6,384	1	-	
15552710	15552710N		10	TR 91/A	TP 98	TP 99	7,026	1	-	
15552711	15552711N		11	TR 91/A	TP 98	TP 99	7,668	1	-	
15552712	15552712N		12	TR 91/A	TP 98	TP 99	8,310	1	-	
15552713	15552713N		13	TR 91/A	TP 98	TP 99	8,952	1	-	

CD 1865

finitura gialla	finitura nichelata	MISURA	N. VIE							
COD.	COD.									
16552402	16552402N	G 1 1/4 x (W24x19)	2	TR 91	TP 95	TP 97	2,194	1	-	
16552403	16552403N		3	TR 91	TP 95	TP 97	2,936	1	-	
16552404	16552404N		4	TR 91	TP 95	TP 97	3,678	1	-	
16552405	16552405N		5	TR 91	TP 95	TP 97	4,420	1	-	
16552406	16552406N		6	TR 91	TP 95	TP 97	5,162	1	-	
16552407	16552407N		7	TR 91	TP 95	TP 97	5,904	1	-	
16552408	16552408N		8	TR 91	TP 95	TP 97	6,646	1	-	
16552409	16552409N		9	TR 91	TP 95	TP 97	7,388	1	-	
16552410	16552410N		10	TR 91	TP 95	TP 97	8,130	1	-	
16552411	16552411N		11	TR 91	TP 95	TP 97	8,872	1	-	
16552412	16552412N		12	TR 91	TP 95	TP 97	9,614	1	-	
16552413	16552413N		13	TR 91	TP 95	TP 97	10,356	1	-	

CD 1868

finitura gialla	finitura nichelata	MISURA	N. VIE							
COD.	COD.									
16552702	16552702N	G 1 1/4 x G 3/4 EK	2	TR 91/A	TP 98	TP 99	2,234	1	-	
16552703	16552703N		3	TR 91/A	TP 98	TP 99	2,996	1	-	
16552704	16552704N		4	TR 91/A	TP 98	TP 99	3,758	1	-	
16552705	16552705N		5	TR 91/A	TP 98	TP 99	4,520	1	-	
16552706	16552706N		6	TR 91/A	TP 98	TP 99	5,282	1	-	
16552707	16552707N		7	TR 91/A	TP 98	TP 99	6,044	1	-	
16552708	16552708N		8	TR 91/A	TP 98	TP 99	6,806	1	-	
16552709	16552709N		9	TR 91/A	TP 98	TP 99	7,568	1	-	
16552710	16552710N		10	TR 91/A	TP 98	TP 99	8,330	1	-	
16552711	16552711N		11	TR 91/A	TP 98	TP 99	9,092	1	-	
16552712	16552712N		12	TR 91/A	TP 98	TP 99	9,854	1	-	
16552713	16552713N		13	TR 91/A	TP 98	TP 99	10,616	1	-	



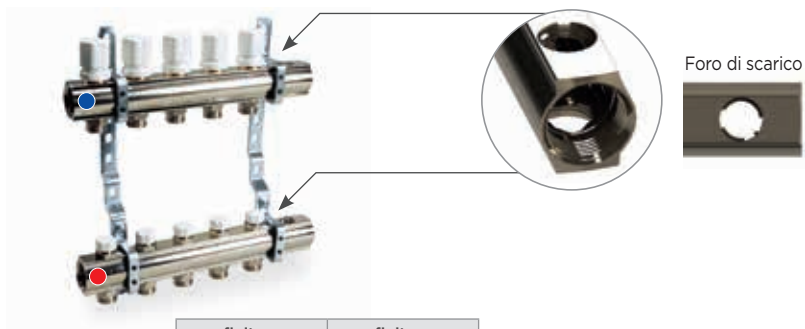

Collettore di distribuzione con 2 fori di scarico da 1/2 premontato composto da:

- 1 collettore di ritorno con valvole incorporate predisposte per la regolazione elettrotermica e con volantino di comando manuale
- 1 collettore di andata con detentori incorporati predisposto per la doppia regolazione
- 2 supporti metallici.

CD 467

finitura gialla	finitura nichelata	MISURA	N. VIE						
COD.	COD.								
15562402	15562402N	G 1" x (W24x19)	2	TR 91	TP 95	TP 97	2,230	1	-
15562403	15562403N		3	TR 91	TP 95	TP 97	2,852	1	-
15562404	15562404N		4	TR 91	TP 95	TP 97	3,474	1	-
15562405	15562405N		5	TR 91	TP 95	TP 97	4,096	1	-
15562406	15562406N		6	TR 91	TP 95	TP 97	4,718	1	-
15562407	15562407N		7	TR 91	TP 95	TP 97	5,340	1	-
15562408	15562408N		8	TR 91	TP 95	TP 97	5,962	1	-
15562409	15562409N		9	TR 91	TP 95	TP 97	6,584	1	-
15562410	15562410N		10	TR 91	TP 95	TP 97	7,206	1	-
15562411	15562411N		11	TR 91	TP 95	TP 97	7,828	1	-
15562412	15562412N		12	TR 91	TP 95	TP 97	8,450	1	-

CD 469

finitura gialla	finitura nichelata	MISURA	N. VIE						
COD.	COD.								
15562702	15562702N	G 1" x G 3/4 EK	2	TR 91/A	TP 98	TP 99	2,270	1	-
15562703	15562703N		3	TR 91/A	TP 98	TP 99	2,912	1	-
15562704	15562704N		4	TR 91/A	TP 98	TP 99	3,554	1	-
15562705	15562705N		5	TR 91/A	TP 98	TP 99	4,196	1	-
15562706	15562706N		6	TR 91/A	TP 98	TP 99	4,838	1	-
15562707	15562707N		7	TR 91/A	TP 98	TP 99	5,480	1	-
15562708	15562708N		8	TR 91/A	TP 98	TP 99	6,122	1	-
15562709	15562709N		9	TR 91/A	TP 98	TP 99	6,764	1	-
15562710	15562710N		10	TR 91/A	TP 98	TP 99	7,406	1	-
15562711	15562711N		11	TR 91/A	TP 98	TP 99	8,048	1	-
15562712	15562712N		12	TR 91/A	TP 98	TP 99	8,690	1	-

CD 1867

finitura gialla	finitura nichelata	MISURA	N. VIE						
COD.	COD.								
16562402	16562402N	G 1 1/4 x (W24x19)	2	TR 91	TP 95	TP 97	2,694	1	-
16562403	16562403N		3	TR 91	TP 95	TP 97	3,436	1	-
16562404	16562404N		4	TR 91	TP 95	TP 97	4,178	1	-
16562405	16562405N		5	TR 91	TP 95	TP 97	4,920	1	-
16562406	16562406N		6	TR 91	TP 95	TP 97	5,662	1	-
16562407	16562407N		7	TR 91	TP 95	TP 97	6,404	1	-
16562408	16562408N		8	TR 91	TP 95	TP 97	7,146	1	-
16562409	16562409N		9	TR 91	TP 95	TP 97	7,888	1	-
16562410	16562410N		10	TR 91	TP 95	TP 97	8,630	1	-
16562411	16562411N		11	TR 91	TP 95	TP 97	9,372	1	-
16562412	16562412N		12	TR 91	TP 95	TP 97	10,114	1	-

CD 1869

finitura gialla	finitura nichelata	MISURA	N. VIE						
COD.	COD.								
16562702	16562702N	G 1 1/4 x G 3/4 EK	2	TR 91/A	TP 98	TP 99	2,734	1	-
16562703	16562703N		3	TR 91/A	TP 98	TP 99	3,496	1	-
16562704	16562704N		4	TR 91/A	TP 98	TP 99	4,258	1	-
16562705	16562705N		5	TR 91/A	TP 98	TP 99	5,020	1	-
16562706	16562706N		6	TR 91/A	TP 98	TP 99	5,782	1	-
16562707	16562707N		7	TR 91/A	TP 98	TP 99	6,544	1	-
16562708	16562708N		8	TR 91/A	TP 98	TP 99	7,306	1	-
16562709	16562709N		9	TR 91/A	TP 98	TP 99	8,068	1	-
16562710	16562710N		10	TR 91/A	TP 98	TP 99	8,830	1	-
16562711	16562711N		11	TR 91/A	TP 98	TP 99	9,592	1	-
16562712	16562712N		12	TR 91/A	TP 98	TP 99	10,354	1	-



Raccordi per tubo rame



Raccordi per tubo plastica



Raccordi per tubo multistrato



Raccordi: capitolo 7



Accessori: capitolo 2.A



Collettore di distribuzione premontato composto da:

- 1 collettore di ritorno con valvole incorporate predisposte per la regolazione elettrotermica e con cappucci di protezione
- 1 collettore di andata con regolatori misuratori di portata
- 2 supporti metallici.

CD 2478

finitura gialla	finitura nichelata	MISURA	N. VIE						
COD.	COD.								
15612402	15612402N	G 1" x (W24x19)	2	TR 91	TP 95	TP 97	1,562	1	-
15612403	15612403N		3	TR 91	TP 95	TP 97	2,188	1	-
15612404	15612404N		4	TR 91	TP 95	TP 97	2,824	1	-
15612405	15612405N		5	TR 91	TP 95	TP 97	3,500	1	-
15612406	15612406N		6	TR 91	TP 95	TP 97	4,116	1	-
15612407	15612407N		7	TR 91	TP 95	TP 97	4,752	1	-
15612408	15612408N		8	TR 91	TP 95	TP 97	5,398	1	-
15612409	15612409N		9	TR 91	TP 95	TP 97	6,024	1	-
15612410	15612410N		10	TR 91	TP 95	TP 97	6,660	1	-
15612411	15612411N		11	TR 91	TP 95	TP 97	7,296	1	-
15612412	15612412N		12	TR 91	TP 95	TP 97	7,912	1	-
15612413	15612413N		13	TR 91	TP 95	TP 97	8,528	1	-

CD 2473

finitura gialla	finitura nichelata	MISURA	N. VIE						
COD.	COD.								
15612702	15612702N	G 1" x G 3/4 EK	2	TR 91/A	TP 98	TP 99	1,592	1	-
15612703	15612703N		3	TR 91/A	TP 98	TP 99	2,233	1	-
15612704	15612704N		4	TR 91/A	TP 98	TP 99	2,884	1	-
15612705	15612705N		5	TR 91/A	TP 98	TP 99	3,575	1	-
15612706	15612706N		6	TR 91/A	TP 98	TP 99	4,206	1	-
15612707	15612707N		7	TR 91/A	TP 98	TP 99	4,857	1	-
15612708	15612708N		8	TR 91/A	TP 98	TP 99	5,518	1	-
15612709	15612709N		9	TR 91/A	TP 98	TP 99	6,159	1	-
15612710	15612710N		10	TR 91/A	TP 98	TP 99	6,810	1	-
15612711	15612711N		11	TR 91/A	TP 98	TP 99	7,461	1	-
15612712	15612712N		12	TR 91/A	TP 98	TP 99	8,092	1	-
15612713	15612713N		13	TR 91/A	TP 98	TP 99	8,723	1	-

CD 2878

finitura gialla	finitura nichelata	MISURA	N. VIE						
COD.	COD.								
16612402	16612402N	G 1"1/4 x (W24x19)	2	TR 91	TP 95	TP 97	1,928	1	-
16612403	16612403N		3	TR 91	TP 95	TP 97	2,707	1	-
16612404	16612404N		4	TR 91	TP 95	TP 97	3,476	1	-
16612405	16612405N		5	TR 91	TP 95	TP 97	4,295	1	-
16612406	16612406N		6	TR 91	TP 95	TP 97	5,024	1	-
16612407	16612407N		7	TR 91	TP 95	TP 97	5,793	1	-
16612408	16612408N		8	TR 91	TP 95	TP 97	6,542	1	-
16612409	16612409N		9	TR 91	TP 95	TP 97	7,341	1	-
16612410	16612410N		10	TR 91	TP 95	TP 97	8,110	1	-
16612411	16612411N		11	TR 91	TP 95	TP 97	9,189	1	-
16612412	16612412N		12	TR 91	TP 95	TP 97	9,668	1	-
16612413	16612413N		13	TR 91	TP 95	TP 97	10,147	1	-

CD 2873



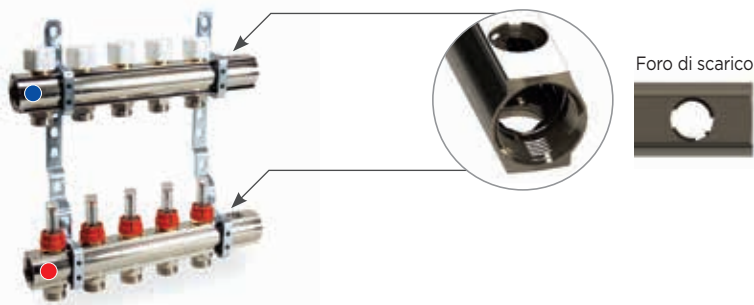



finitura gialla	finitura nichelata	MISURA	N. VIE						
COD.	COD.								
16612702	16612702N	G 1"1/4 x G 3/4 EK	2	TR 91/A	TP 98	TP 99	1,958	1	-
16612703	16612703N		3	TR 91/A	TP 98	TP 99	2,752	1	-
16612704	16612704N		4	TR 91/A	TP 98	TP 99	3,536	1	-
16612705	16612705N		5	TR 91/A	TP 98	TP 99	4,320	1	-
16612706	16612706N		6	TR 91/A	TP 98	TP 99	5,114	1	-
16612707	16612707N		7	TR 91/A	TP 98	TP 99	5,898	1	-
16612708	16612708N		8	TR 91/A	TP 98	TP 99	6,662	1	-
16612709	16612709N		9	TR 91/A	TP 98	TP 99	7,476	1	-
16612710	16612710N		10	TR 91/A	TP 98	TP 99	8,260	1	-
16612711	16612711N		11	TR 91/A	TP 98	TP 99	9,084	1	-
16612712	16612712N		12	TR 91/A	TP 98	TP 99	9,848	1	-
16612713	16612713N		13	TR 91/A	TP 98	TP 99	10,612	1	-









Collettore di distribuzione premontato con 2 fori di scarico da 1/2 composto da:

- 1 collettore di ritorno con valvole incorporate predisposte per la regolazione elettrotermica e con cappucci di protezione
- 1 collettore di andata con regolatori e misuratori di portata
- 2 supporti metallici.

CD 2479

finitura gialla	finitura nichelata	MISURA	N. VIE						
COD.	COD.								
15622402	15622402N	G 1" x (W24x19)	2	TR 91	TP 95	TP 97	1,932	1	-
15622403	15622403N		3	TR 91	TP 95	TP 97	2,568	1	-
15622404	15622404N		4	TR 91	TP 95	TP 97	3,244	1	-
15622405	15622405N		5	TR 91	TP 95	TP 97	3,860	1	-
15622406	15622406N		6	TR 91	TP 95	TP 97	4,496	1	-
15622407	15622407N		7	TR 91	TP 95	TP 97	5,142	1	-
15622408	15622408N		8	TR 91	TP 95	TP 97	5,768	1	-
15622409	15622409N		9	TR 91	TP 95	TP 97	6,404	1	-
15622410	15622410N		10	TR 91	TP 95	TP 97	7,040	1	-
15622411	15622411N		11	TR 91	TP 95	TP 97	7,656	1	-
15622412	15622412N		12	TR 91	TP 95	TP 97	8,322	1	-

CD 2477

finitura gialla	finitura nichelata	MISURA	N. VIE						
COD.	COD.								
15622702	15622702N	G 1" x G 3/4 EK	2	TR 91/A	TP 98	TP 99	1,962	1	-
15622703	15622703N		3	TR 91/A	TP 98	TP 99	2,613	1	-
15622704	15622704N		4	TR 91/A	TP 98	TP 99	3,304	1	-
15622705	15622705N		5	TR 91/A	TP 98	TP 99	3,935	1	-
15622706	15622706N		6	TR 91/A	TP 98	TP 99	4,586	1	-
15622707	15622707N		7	TR 91/A	TP 98	TP 99	5,247	1	-
15622708	15622708N		8	TR 91/A	TP 98	TP 99	5,888	1	-
15622709	15622709N		9	TR 91/A	TP 98	TP 99	6,539	1	-
15622710	15622710N		10	TR 91/A	TP 98	TP 99	7,190	1	-
15622711	15622711N		11	TR 91/A	TP 98	TP 99	7,821	1	-
15622712	15622712N		12	TR 91/A	TP 98	TP 99	8,502	1	-

CD 2879

finitura gialla	finitura nichelata	MISURA	N. VIE						
COD.	COD.								
16622402	16622402N	G 1"1/4 x (W24x19)	2	TR 91	TP 95	TP 97	2,438	1	-
16622403	16622403N		3	TR 91	TP 95	TP 97	3,207	1	-
16622404	16622404N		4	TR 91	TP 95	TP 97	3,976	1	-
16622405	16622405N		5	TR 91	TP 95	TP 97	4,755	1	-
16622406	16622406N		6	TR 91	TP 95	TP 97	5,524	1	-
16622407	16622407N		7	TR 91	TP 95	TP 97	6,273	1	-
16622408	16622408N		8	TR 91	TP 95	TP 97	7,072	1	-
16622409	16622409N		9	TR 91	TP 95	TP 97	7,841	1	-
16622410	16622410N		10	TR 91	TP 95	TP 97	8,650	1	-
16622411	16622411N		11	TR 91	TP 95	TP 97	9,399	1	-
16622412	16622412N		12	TR 91	TP 95	TP 97	10,148	1	-

CD 2877

finitura gialla	finitura nichelata	MISURA	N. VIE						
COD.	COD.								
16622702	16622702N	G 1"1/4 x G 3/4 EK	2	TR 91/A	TP 98	TP 99	2,468	1	-
16622703	16622703N		3	TR 91/A	TP 98	TP 99	3,252	1	-
16622704	16622704N		4	TR 91/A	TP 98	TP 99	4,036	1	-
16622705	16622705N		5	TR 91/A	TP 98	TP 99	4,830	1	-
16622706	16622706N		6	TR 91/A	TP 98	TP 99	5,614	1	-
16622707	16622707N		7	TR 91/A	TP 98	TP 99	6,378	1	-
16622708	16622708N		8	TR 91/A	TP 98	TP 99	7,192	1	-
16622709	16622709N		9	TR 91/A	TP 98	TP 99	7,976	1	-
16622710	16622710N		10	TR 91/A	TP 98	TP 99	8,800	1	-
16622711	16622711N		11	TR 91/A	TP 98	TP 99	9,564	1	-
16622712	16622712N		12	TR 91/A	TP 98	TP 99	10,328	1	-



Raccordi per tubo rame



Raccordi per tubo plastica



Raccordi per tubo multistrato



Raccordi: capitolo 7









Accessori: capitolo 2.A





Collettore di distribuzione premontato composto da:

- 1 collettore di ritorno con valvole incorporate predisposte per la regolazione elettrotermica e con volantino di comando manuale
- 1 collettore di andata con regolatori e misuratori di portata
- 2 supporti metallici.







CD 478

finitura gialla	finitura nichelata	MISURA	N. VIE						
COD.	COD.								
15652402	15652402N	G 1" x (W24x19)	2	TR 91	TP 95	TP 97	1,582	1	-
15652403	15652403N		3	TR 91	TP 95	TP 97	2,218	1	-
15652404	15652404N		4	TR 91	TP 95	TP 97	2,864	1	-
15652405	15652405N		5	TR 91	TP 95	TP 97	3,550	1	-
15652406	15652406N		6	TR 91	TP 95	TP 97	4,176	1	-
15652407	15652407N		7	TR 91	TP 95	TP 97	4,822	1	-
15652408	15652408N		8	TR 91	TP 95	TP 97	5,478	1	-
15652409	15652409N		9	TR 91	TP 95	TP 97	6,114	1	-
15652410	15652410N		10	TR 91	TP 95	TP 97	6,760	1	-
15652411	15652411N		11	TR 91	TP 95	TP 97	7,406	1	-
15652412	15652412N		12	TR 91	TP 95	TP 97	8,032	1	-
15652413	15652413N		13	TR 91	TP 95	TP 97	8,658	1	-



CD 473

finitura gialla	finitura nichelata	MISURA	N. VIE						
COD.	COD.								
15652702	15652702N	G 1" x G 3/4 EK	2	TR 91/A	TP 98	TP 99	1,612	1	-
15652703	15652703N		3	TR 91/A	TP 98	TP 99	2,263	1	-
15652704	15652704N		4	TR 91/A	TP 98	TP 99	2,924	1	-
15652705	15652705N		5	TR 91/A	TP 98	TP 99	3,625	1	-
15652706	15652706N		6	TR 91/A	TP 98	TP 99	4,266	1	-
15652707	15652707N		7	TR 91/A	TP 98	TP 99	4,927	1	-
15652708	15652708N		8	TR 91/A	TP 98	TP 99	5,598	1	-
15652709	15652709N		9	TR 91/A	TP 98	TP 99	6,249	1	-
15652710	15652710N		10	TR 91/A	TP 98	TP 99	6,910	1	-
15652711	15652711N		11	TR 91/A	TP 98	TP 99	7,571	1	-
15652712	15652712N		12	TR 91/A	TP 98	TP 99	8,212	1	-
15652713	15652713N		13	TR 91/A	TP 98	TP 99	8,853	1	-

CD 1878

finitura gialla	finitura nichelata	MISURA	N. VIE						
COD.	COD.								
16652402	16652402N	G 1 1/4 x (W24x19)	2	TR 91	TP 95	TP 97	1,948	1	-
16652403	16652403N		3	TR 91	TP 95	TP 97	2,737	1	-
16652404	16652404N		4	TR 91	TP 95	TP 97	3,516	1	-
16652405	16652405N		5	TR 91	TP 95	TP 97	4,295	1	-
16652406	16652406N		6	TR 91	TP 95	TP 97	5,084	1	-
16652407	16652407N		7	TR 91	TP 95	TP 97	5,863	1	-
16652408	16652408N		8	TR 91	TP 95	TP 97	6,622	1	-
16652409	16652409N		9	TR 91	TP 95	TP 97	7,431	1	-
16652410	16652410N		10	TR 91	TP 95	TP 97	8,210	1	-
16652411	16652411N		11	TR 91	TP 95	TP 97	9,029	1	-
16652412	16652412N		12	TR 91	TP 95	TP 97	9,788	1	-
16652413	16652413N		13	TR 91	TP 95	TP 97	10,547	1	-

CD 1873

finitura gialla	finitura nichelata	MISURA	N. VIE						
COD.	COD.								
16652702	16652702N	G 1 1/4 x G 3/4 EK	2	TR 91/A	TP 98	TP 99	1,978	1	-
16652703	16652703N		3	TR 91/A	TP 98	TP 99	2,782	1	-
16652704	16652704N		4	TR 91/A	TP 98	TP 99	3,576	1	-
16652705	16652705N		5	TR 91/A	TP 98	TP 99	4,370	1	-
16652706	16652706N		6	TR 91/A	TP 98	TP 99	5,174	1	-
16652707	16652707N		7	TR 91/A	TP 98	TP 99	5,968	1	-
16652708	16652708N		8	TR 91/A	TP 98	TP 99	6,742	1	-
16652709	16652709N		9	TR 91/A	TP 98	TP 99	7,566	1	-
16652710	16652710N		10	TR 91/A	TP 98	TP 99	8,360	1	-
16652711	16652711N		11	TR 91/A	TP 98	TP 99	9,194	1	-
16652712	16652712N		12	TR 91/A	TP 98	TP 99	9,968	1	-
16652713	16652713N		13	TR 91/A	TP 98	TP 99	10,742	1	-



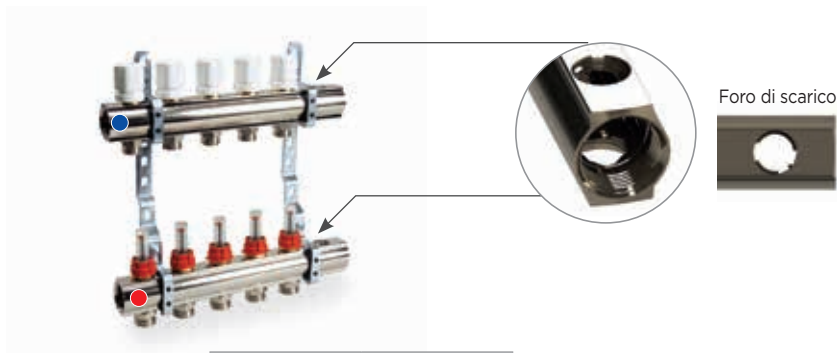













Collettore di distribuzione premontato con 2 fori di scarico da 1/2 composto da:

- 1 collettore di ritorno con valvole incorporate predisposte per la regolazione elettrotermica e con volantino di comando manuale
- 1 collettore di andata con regolatori e misuratori di portata
- 2 supporti metallici.





CD 479

finitura gialla	finitura nichelata	MISURA	N. VIE						
COD.	COD.								
15662402	15662402N	G 1" x (W24x19)	2	TR 91	TP 95	TP 97	1,952	1	-
15662403	15662403N		3	TR 91	TP 95	TP 97	2,598	1	-
15662404	15662404N		4	TR 91	TP 95	TP 97	3,284	1	-
15662405	15662405N		5	TR 91	TP 95	TP 97	3,910	1	-
15662406	15662406N		6	TR 91	TP 95	TP 97	4,556	1	-
15662407	15662407N		7	TR 91	TP 95	TP 97	5,212	1	-
15662408	15662408N		8	TR 91	TP 95	TP 97	5,848	1	-
15662409	15662409N		9	TR 91	TP 95	TP 97	6,494	1	-
15662410	15662410N		10	TR 91	TP 95	TP 97	7,140	1	-
15662411	15662411N		11	TR 91	TP 95	TP 97	7,766	1	-
15662412	15662412N		12	TR 91	TP 95	TP 97	8,442	1	-

CD 477

finitura gialla	finitura nichelata	MISURA	N. VIE						
COD.	COD.								
15662702	15662702N	G 1" x G 3/4 EK	2	TR 91/A	TP 98	TP 99	1,982	1	-
15662703	15662703N		3	TR 91/A	TP 98	TP 99	2,643	1	-
15662704	15662704N		4	TR 91/A	TP 98	TP 99	3,344	1	-
15662705	15662705N		5	TR 91/A	TP 98	TP 99	3,985	1	-
15662706	15662706N		6	TR 91/A	TP 98	TP 99	4,646	1	-
15662707	15662707N		7	TR 91/A	TP 98	TP 99	5,317	1	-
15662708	15662708N		8	TR 91/A	TP 98	TP 99	5,968	1	-
15662709	15662709N		9	TR 91/A	TP 98	TP 99	6,629	1	-
15662710	15662710N		10	TR 91/A	TP 98	TP 99	7,290	1	-
15662711	15662711N		11	TR 91/A	TP 98	TP 99	7,931	1	-
15662712	15662712N		12	TR 91/A	TP 98	TP 99	8,622	1	-

CD 1879

finitura gialla	finitura nichelata	MISURA	N. VIE						
COD.	COD.								
16662402	16662402N	G 1 1/4 x (W24x19)	2	TR 91	TP 95	TP 97	2,458	1	-
16662403	16662403N		3	TR 91	TP 95	TP 97	3,237	1	-
16662404	16662404N		4	TR 91	TP 95	TP 97	4,016	1	-
16662405	16662405N		5	TR 91	TP 95	TP 97	4,805	1	-
16662406	16662406N		6	TR 91	TP 95	TP 97	5,584	1	-
16662407	16662407N		7	TR 91	TP 95	TP 97	6,343	1	-
16662408	16662408N		8	TR 91	TP 95	TP 97	7,152	1	-
16662409	16662409N		9	TR 91	TP 95	TP 97	7,931	1	-
16662410	16662410N		10	TR 91	TP 95	TP 97	8,750	1	-
16662411	16662411N		11	TR 91	TP 95	TP 97	9,509	1	-
16662412	16662412N		12	TR 91	TP 95	TP 97	10,268	1	-

CD 1877

finitura gialla	finitura nichelata	MISURA	N. VIE						
COD.	COD.								
16662702	16662702N	G 1 1/4 x G 3/4 EK	2	TR 91/A	TP 98	TP 99	2,488	1	-
16662703	16662703N		3	TR 91/A	TP 98	TP 99	3,282	1	-
16662704	16662704N		4	TR 91/A	TP 98	TP 99	4,076	1	-
16662705	16662705N		5	TR 91/A	TP 98	TP 99	4,880	1	-
16662706	16662706N		6	TR 91/A	TP 98	TP 99	5,674	1	-
16662707	16662707N		7	TR 91/A	TP 98	TP 99	6,448	1	-
16662708	16662708N		8	TR 91/A	TP 98	TP 99	7,272	1	-
16662709	16662709N		9	TR 91/A	TP 98	TP 99	8,066	1	-
16662710	16662710N		10	TR 91/A	TP 98	TP 99	8,900	1	-
16662711	16662711N		11	TR 91/A	TP 98	TP 99	9,674	1	-
16662712	16662712N		12	TR 91/A	TP 98	TP 99	10,448	1	-



Raccordi per tubo rame



Raccordi per tubo plastica



Raccordi per tubo multistrato



Raccordi: capitolo 7



Accessori: capitolo 2.A



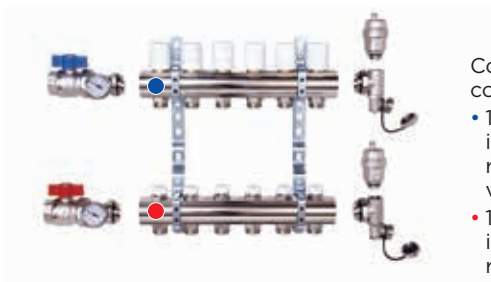



COLLETTORI DI DISTRIBUZIONE PREMONTATI CON ACCESSORI DI INSTALLAZIONE









Collettore di distribuzione premontato composto da:

- 1 collettore di ritorno con valvole incorporate predisposte per la regolazione elettrotermica e con volantino di comando manuale
- 1 collettore di andata con detentori incorporati predisposto per la doppia regolazione.

CD 465M

COD.	MISURA	N. VIE						
15552402MN	G 1" x (W24x19)	2	TR 91	TP 95	TP 97	4,172	1	-
15552403MN		3	TR 91	TP 95	TP 97	4,794	1	-
15552404MN		4	TR 91	TP 95	TP 97	5,416	1	-
15552405MN		5	TR 91	TP 95	TP 97	6,038	1	-
15552406MN		6	TR 91	TP 95	TP 97	6,660	1	-
15552407MN		7	TR 91	TP 95	TP 97	7,282	1	-
15552408MN		8	TR 91	TP 95	TP 97	7,904	1	-
15552409MN		9	TR 91	TP 95	TP 97	8,526	1	-
15552410MN		10	TR 91	TP 95	TP 97	9,148	1	-
15552411MN		11	TR 91	TP 95	TP 97	9,770	1	-
15552412MN		12	TR 91	TP 95	TP 97	10,392	1	-
15552413MN		13	TR 91	TP 95	TP 97	11,014	1	-

CD 468M

COD.	MISURA	N. VIE						
15552702MN	G 1" x G 3/4 EK	2	TR 91/A	TP 98	TP 99	4,212	1	-
15552703MN		3	TR 91/A	TP 98	TP 99	4,854	1	-
15552704MN		4	TR 91/A	TP 98	TP 99	5,496	1	-
15552705MN		5	TR 91/A	TP 98	TP 99	6,138	1	-
15552706MN		6	TR 91/A	TP 98	TP 99	6,780	1	-
15552707MN		7	TR 91/A	TP 98	TP 99	7,422	1	-
15552708MN		8	TR 91/A	TP 98	TP 99	8,064	1	-
15552709MN		9	TR 91/A	TP 98	TP 99	8,706	1	-
15552710MN		10	TR 91/A	TP 98	TP 99	9,348	1	-
15552711MN		11	TR 91/A	TP 98	TP 99	9,990	1	-
15552712MN		12	TR 91/A	TP 98	TP 99	10,632	1	-
15552713MN		13	TR 91/A	TP 98	TP 99	11,274	1	-



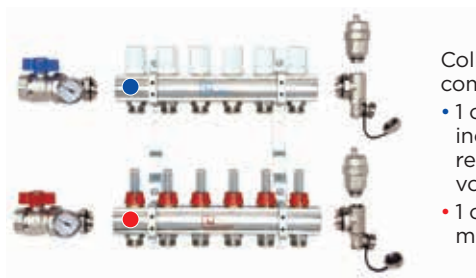













Collettore di distribuzione premontato composto da:

- 1 collettore di ritorno con valvole incorporate predisposte per la regolazione elettrotermica e con volantino di comando manuale
- 1 collettore di andata con regolatori e misuratori di portata.

CD 478M

COD.	MISURA	N. VIE						
15652402MN	G 1" x (W24x19)	2	TR 91	TP 95	TP 97	3,904	1	-
15652403MN		3	TR 91	TP 95	TP 97	4,540	1	-
15652404MN		4	TR 91	TP 95	TP 97	5,186	1	-
15652405MN		5	TR 91	TP 95	TP 97	5,872	1	-
15652406MN		6	TR 91	TP 95	TP 97	6,498	1	-
15652407MN		7	TR 91	TP 95	TP 97	7,144	1	-
15652408MN		8	TR 91	TP 95	TP 97	7,800	1	-
15652409MN		9	TR 91	TP 95	TP 97	8,436	1	-
15652410MN		10	TR 91	TP 95	TP 97	9,082	1	-
15652411MN		11	TR 91	TP 95	TP 97	9,728	1	-
15652412MN		12	TR 91	TP 95	TP 97	10,354	1	-
15652413MN		13	TR 91	TP 95	TP 97	10,98	1	-

CD 473M

COD.	MISURA	N. VIE						
15652702MN	G 1" x G 3/4 EK	2	TR 91/A	TP 98	TP 99	3,934	1	-
15652703MN		3	TR 91/A	TP 98	TP 99	4,585	1	-
15652704MN		4	TR 91/A	TP 98	TP 99	5,246	1	-
15652705MN		5	TR 91/A	TP 98	TP 99	5,947	1	-
15652706MN		6	TR 91/A	TP 98	TP 99	6,588	1	-
15652707MN		7	TR 91/A	TP 98	TP 99	7,249	1	-
15652708MN		8	TR 91/A	TP 98	TP 99	7,920	1	-
15652709MN		9	TR 91/A	TP 98	TP 99	8,571	1	-
15652710MN		10	TR 91/A	TP 98	TP 99	9,232	1	-
15652711MN		11	TR 91/A	TP 98	TP 99	9,893	1	-
15652712MN		12	TR 91/A	TP 98	TP 99	10,534	1	-
15652713MN		13	TR 91/A	TP 98	TP 99	11,175	1	-



Raccordi per tubo rame



Raccordi per tubo plastica



Raccordi per tubo multistrato



Raccordi: capitolo 7



Accessori: capitolo 2.A

DIAGRAMMA DI PORTATA COLLETTORI
COLLETTORI DI DISTRIBUZIONE CON ATTACCO G 1/2 F

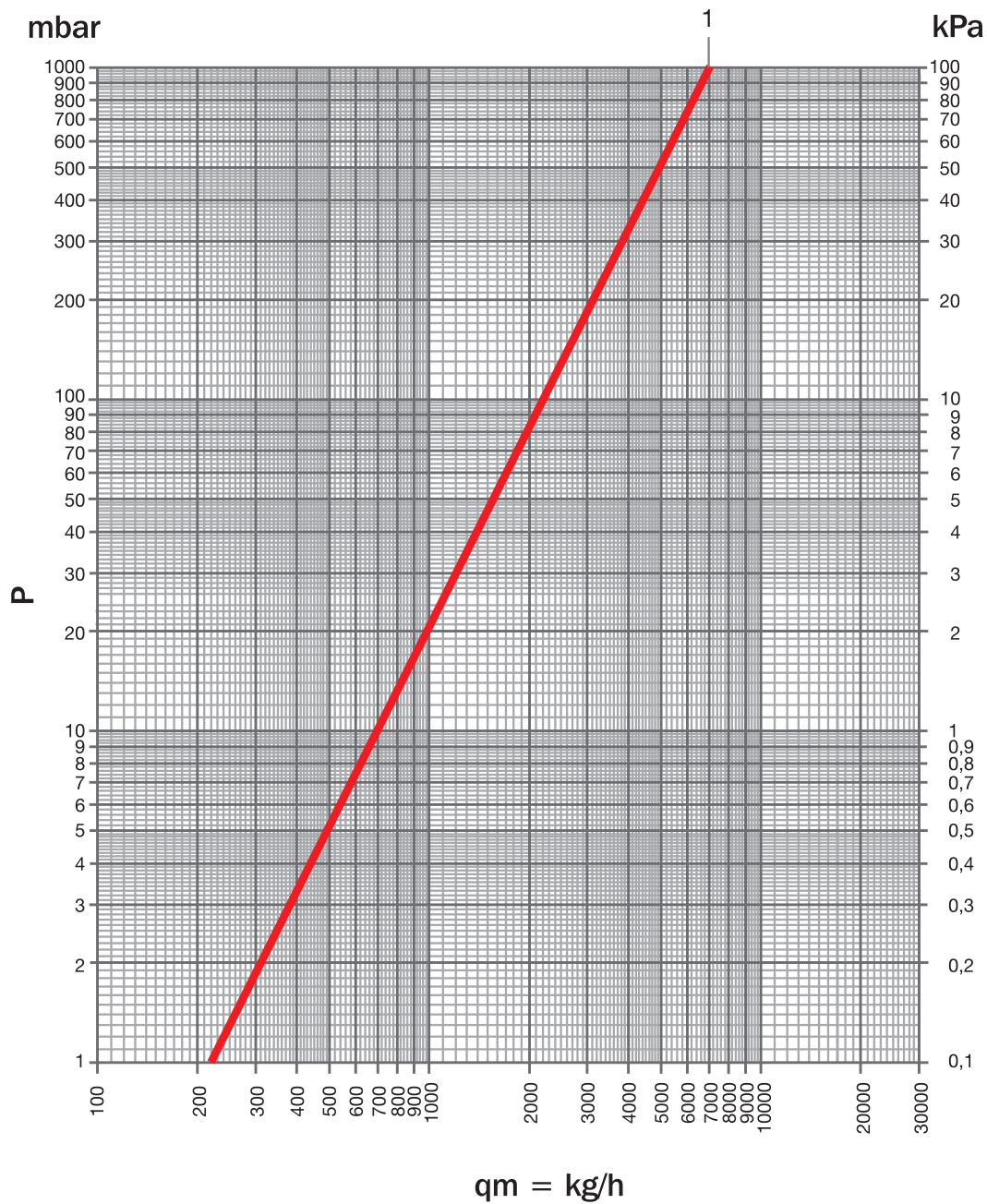

ARTICOLI	MISURA	FORO DI SCARICO	Kvs	POS
CD 451	G 3/4	NO	7.00	1
CD 456	G 1"			
CD 860	G 1 1/4			
CD 457	G 1"	SI	7.00	1
CD 861	G 1 1/4			

MAX PORTATA CONSIGLIATA	
G 3/4	2250 l/h
G 1"	3900 l/h
G 1 1/4	6600 l/h



DIAGRAMMA DI PORTATA COLLETTORI

COLLETTORI DI DISTRIBUZIONE CON ATTACCO PREMONTATO RD 900

 $q_m = \text{kg/h}$

ARTICOLI	MISURA	FORO DI SCARICO	Kvs	POS
CD 459	G 1"	NO	5.1	1
CD 461				
CD 862	G 1 1/4			
CD 864				
CD 460	G 1"	SI	5.1	1
CD 462				
CD 863	G 1 1/4			
CD 865				

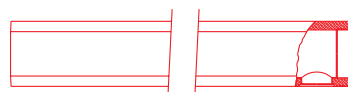
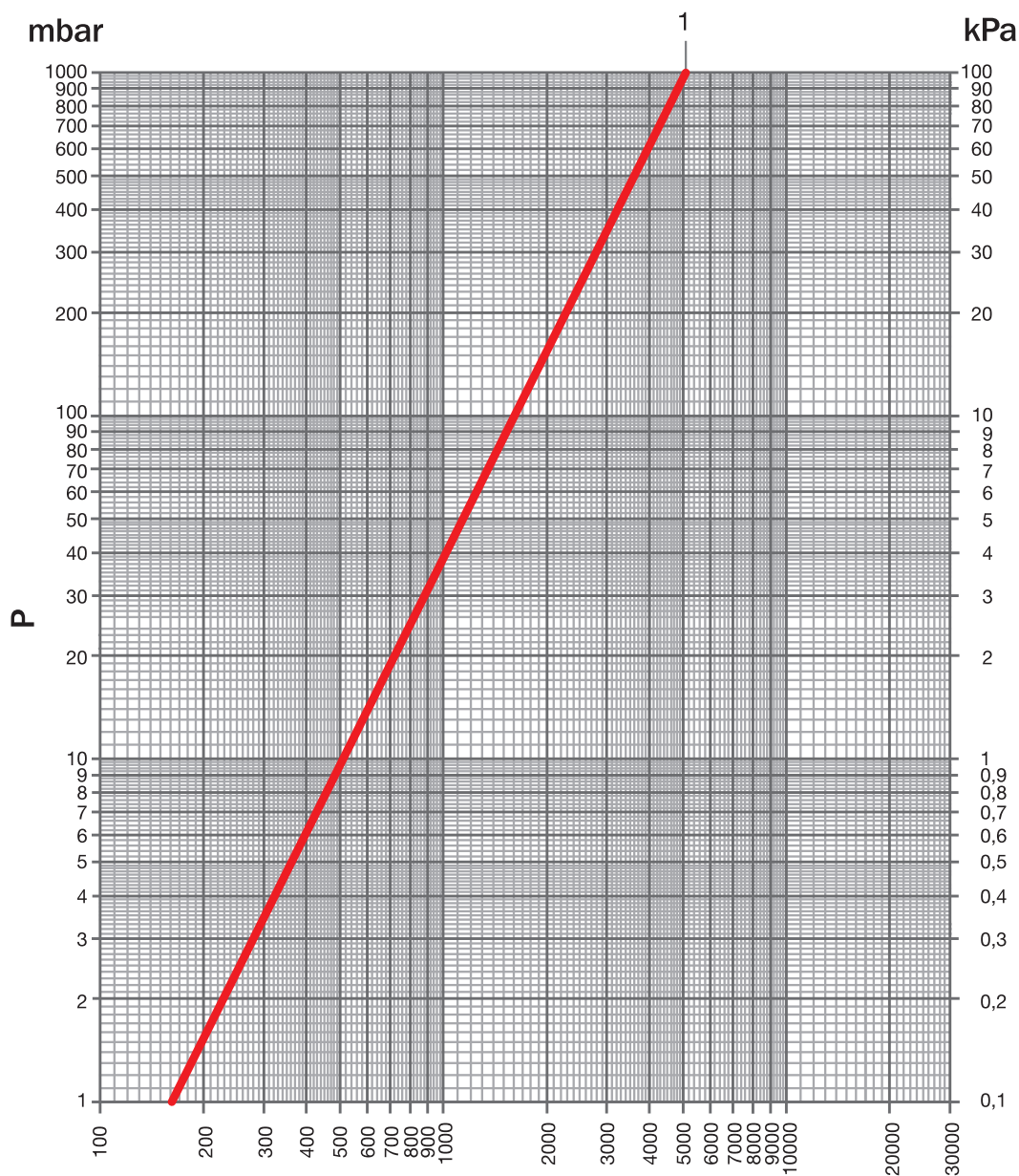
MAX PORTATA CONSIGLIATA	
G 1"	3900 l/h
G 1 1/4	6600 l/h



DIAGRAMMA DI PORTATA COLLETTORI

COLLETTORE DI DISTRIBUZIONE PREMONTATO CON VITONE MANUALE

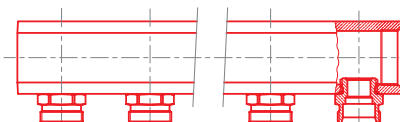
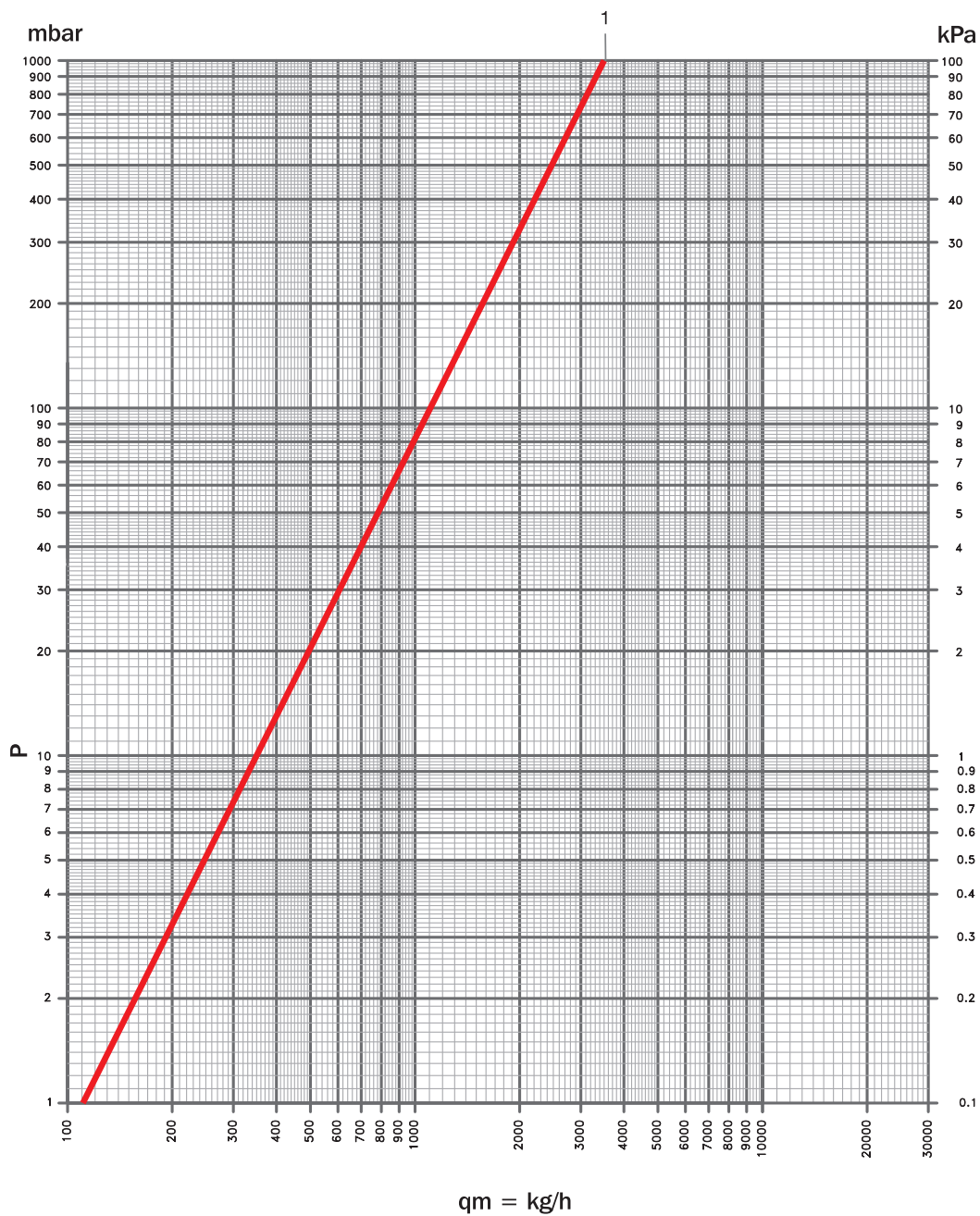

ARTICOLI	MISURA	Kvs	POS
CD 100	G 1"	3.5	1
CD 101			

MAX PORTATA CONSIGLIATA	
G 1"	3900 l/h



DIAGRAMMA DI PORTATA COLLETTORI

COLLETTORI DI DISTRIBUZIONE PREMONTATO CON VALVOLE INCORPORATE

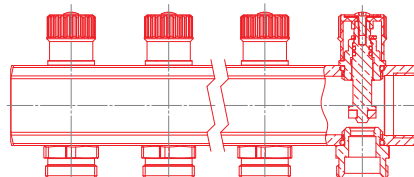
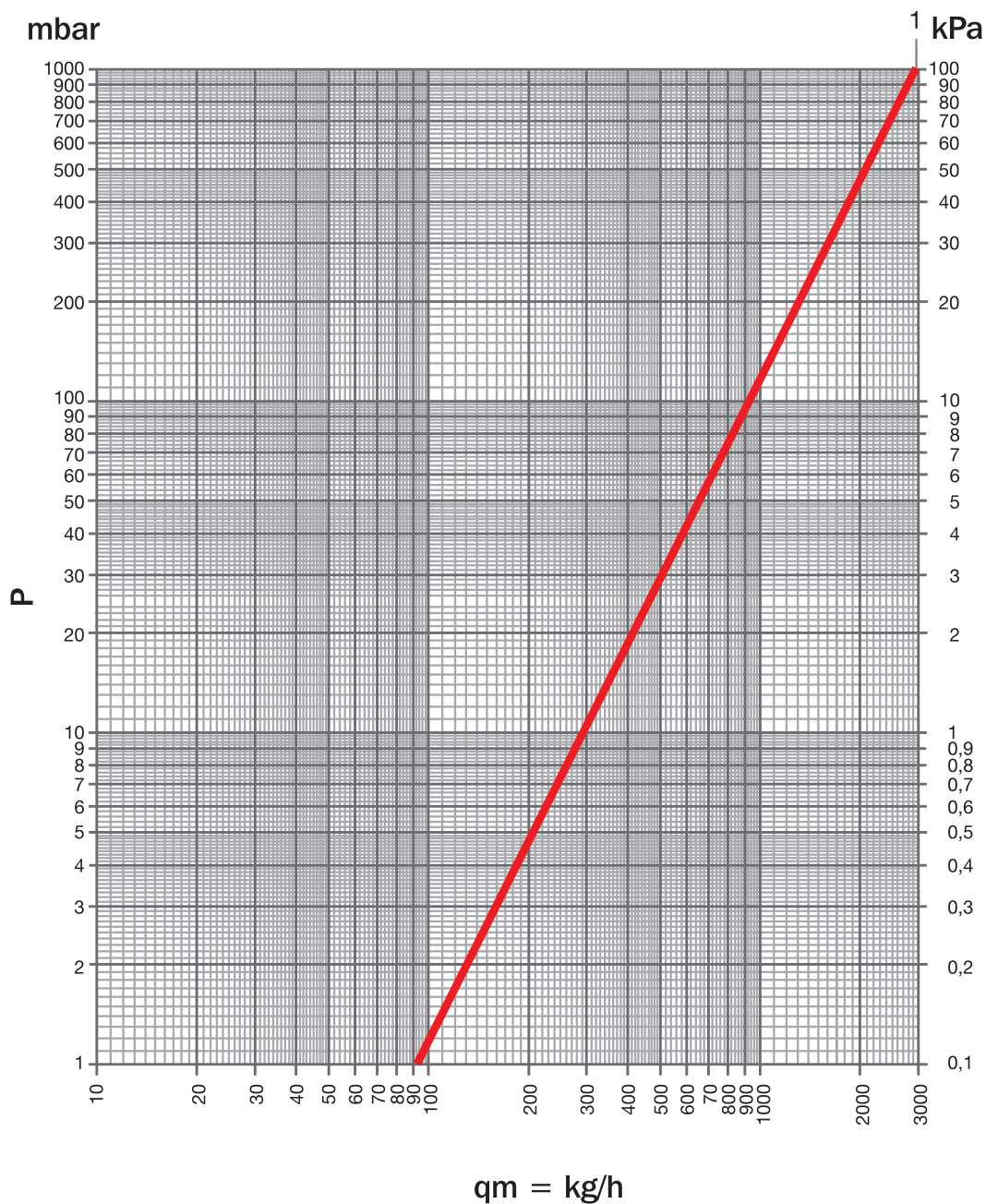

ARTICOLI	MISURA	FORO DI SCARICO	Kvs	POS
CD 1466 CD 466 CD 1446 CD 446	G 1"	NO	2.98	1
CD 875 CD 871 CD 876 CD 872	G 1"1/4			
CD 3466 CD 2466 CD 3446 CD 2446	G 1"	SI		
CD 877 CD 873 CD 878 CD 874	G 1"1/4			

MAX PORTATA CONSIGLIATA	
G 1"	3900 l/h
G 1"1/4	6600 l/h



DIAGRAMMA DI PORTATA COLLETTORI
COLLETTORI DI DISTRIBUZIONE CON DETENTORI



$q_m = \text{kg/h}$

ARTICOLI	MISURA	N. GIRI	FORO DI SCARICO	Kvs	POS
CD 449	G 1"	1/2	NO	0,09	1
CD 448	G 1"	1		0,27	2
CD 879	G 1"1/4	1+1/2		0,76	3
		2		0,98	4
CD 880	G 1"1/4	2+1/2		1,20	5
		3	1,46	6	
CD 1449	G 1"	3+1/2	SI	1,70	7
CD 1448	G 1"	4		1,93	8
		4+1/2		2,19	9
CD 881	G 1"1/4	5		2,47	10
		5+1/2		2,75	11
CD 882	G 1"1/4	tutto aperto		3,01	12

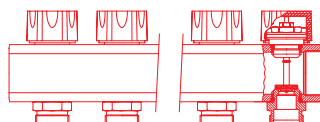
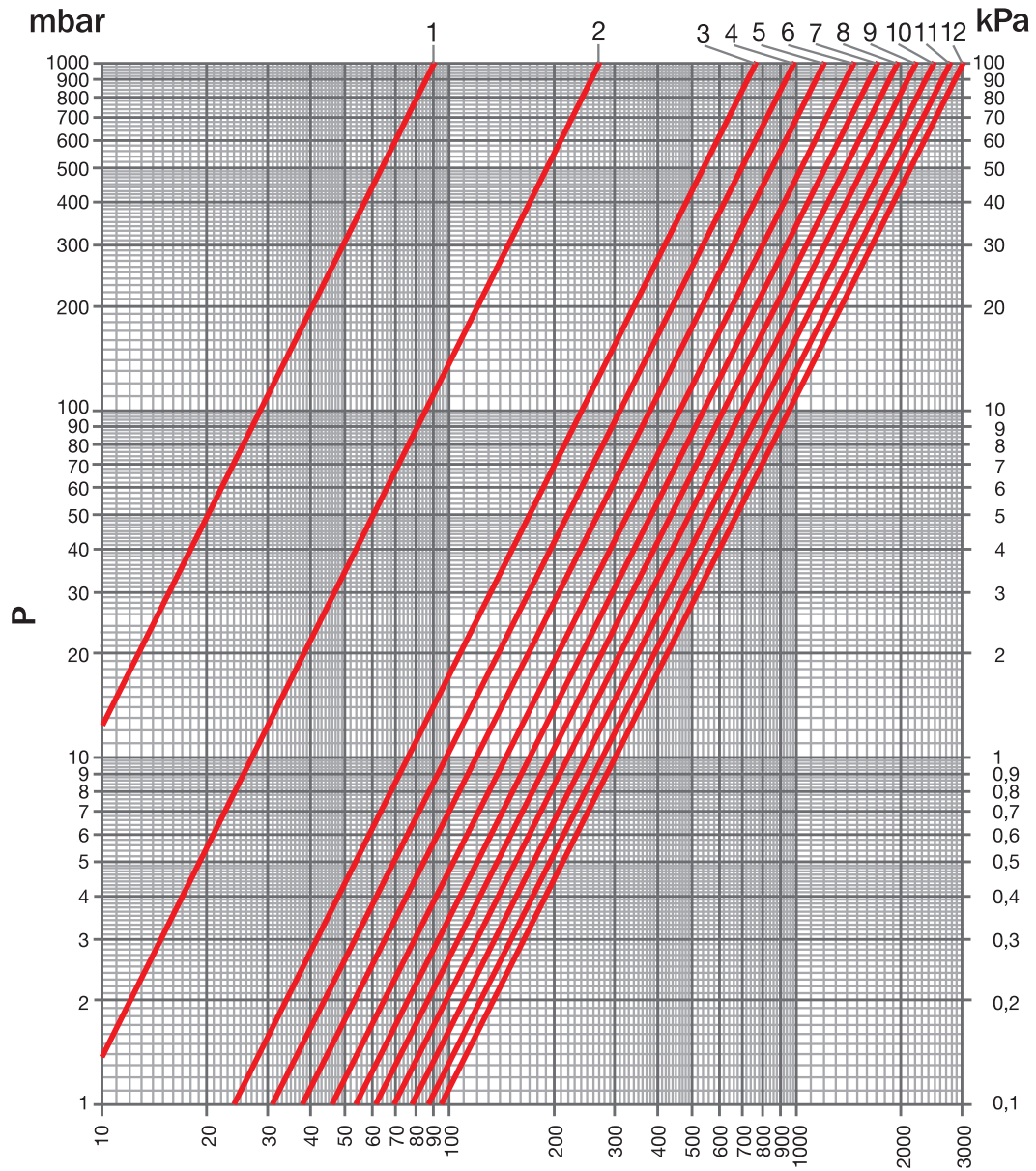
MAX PORTATA CONSIGLIATA	
G 1"	2400 l/h
G 1"1/4	4200 l/h



DIAGRAMMA DI PORTATA COLLETTORI

COLLETTORI DI DISTRIBUZIONE CON REGOLATORI DI PORTATA TM

 $q_m = \text{kg/h}$

ARTICOLI	MISURA	CD + TM	FORO DI SCARICO	Kvs	POS
CD 1474	G 1"	TM 4012	NO	1,05	1
CD 474	G 1"				
CD 868	G 1"1/4		SI		
CD 867	G 1"1/4				
CD 3474	G 1"				
CD 2474	G 1"				
CD 870	G 1"1/4				
CD 869	G 1"1/4				

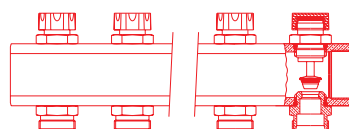
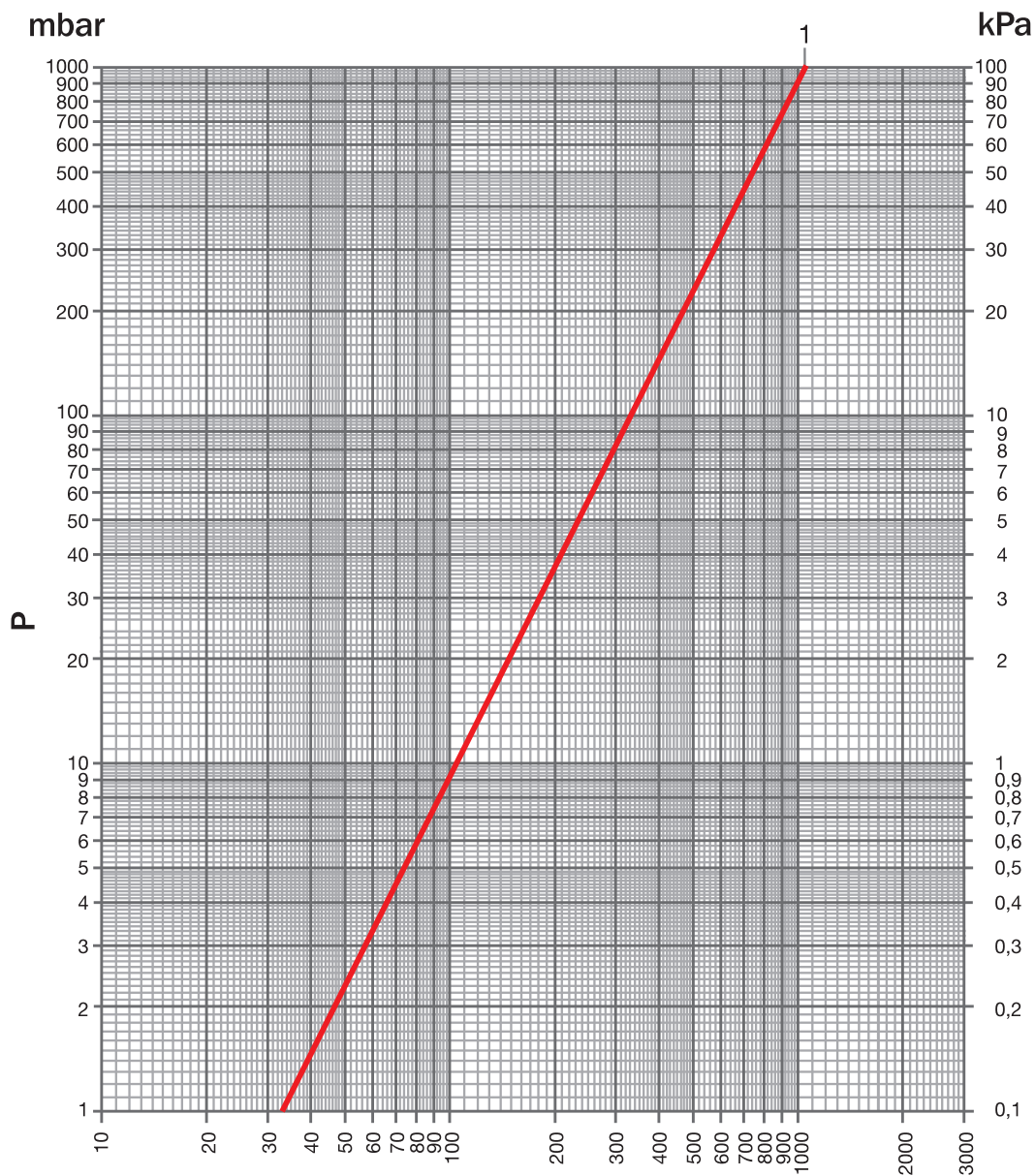
MAX PORTATA CONSIGLIATA

G 1"	1350 l/h
G 1"1/4	3150 l/h



DIAGRAMMA DI PORTATA COLLETTORI

COLLETTORI DI DISTRIBUZIONE CON DETENTORI INCORPORATI

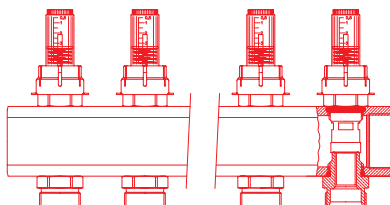
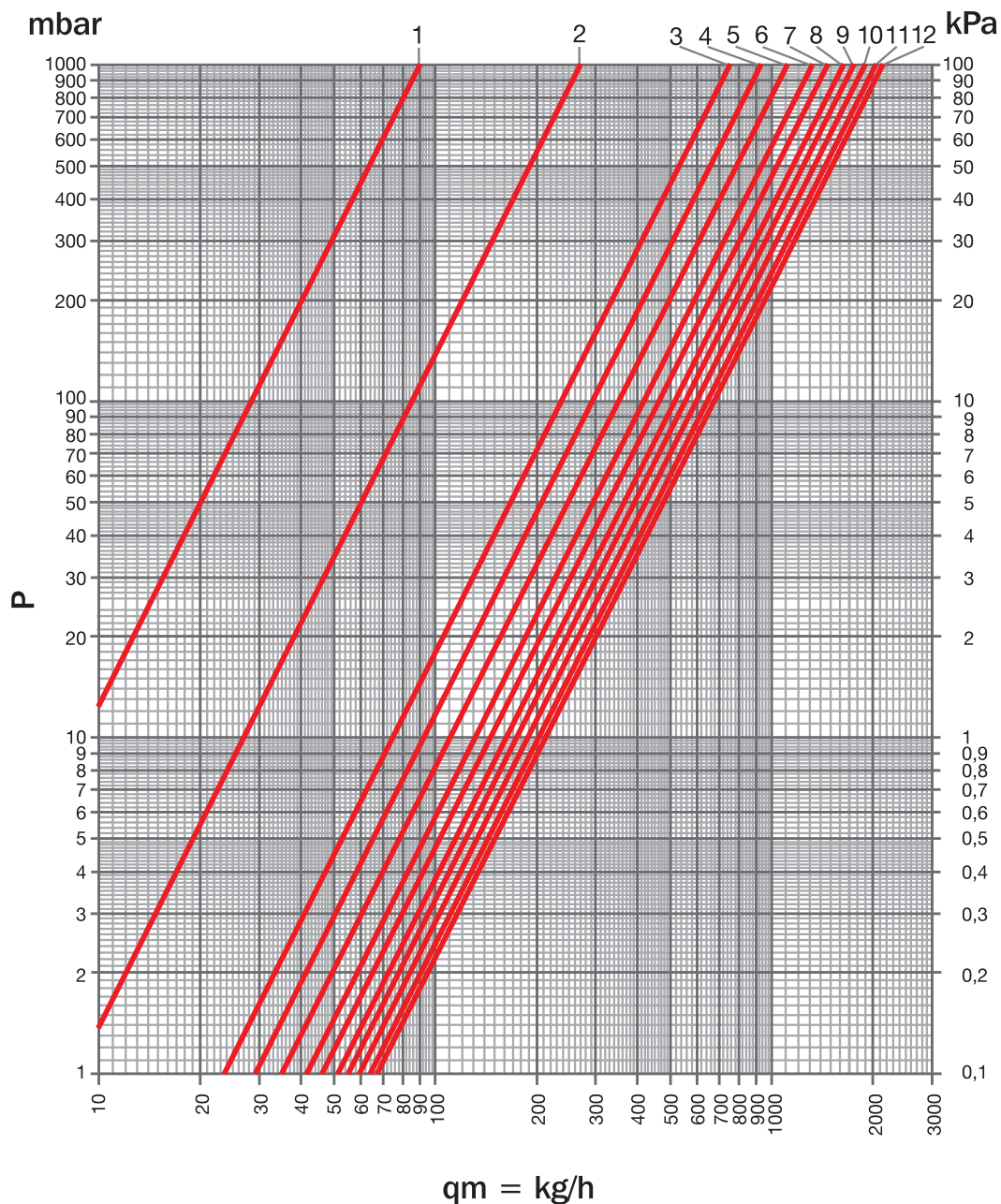

ARTICOLI	MISURA	N. GIRI	FORO DI SCARICO	Kvs	POS
CD 2465 - CD 2468	G 1"	1/2	NO	0,09	1
CD 2865 - CD 2868	G 1"1/4	1		0,27	2
		1+1/2		0,75	3
CD 2467 - CD 2469	G 1"	2	SI	0,93	4
CD 2867 - CD 2869	G 1"1/4	2+1/2		1,11	5
		3	NO	1,31	6
CD 465 - CD 468	G 1"	3+1/2		1,48	7
		4		1,62	8
CD 1865 - CD 1868	G 1"1/4	4+1/2	NO	1,76	9
		5		1,90	10
CD 467 - CD 469	G 1"	5+1/2	SI	2,02	11
CD 1867 - CD 1869	G 1"1/4	tutto aperto		2,12	12

MAX PORTATA CONSIGLIATA	
G 1"	2400 l/h
G 1"1/4	4200 l/h



DIAGRAMMA DI PORTATA COLLETTORI

COLLETTORI DI DISTRIBUZIONE CON REGOLATORI DI PORTATA TM

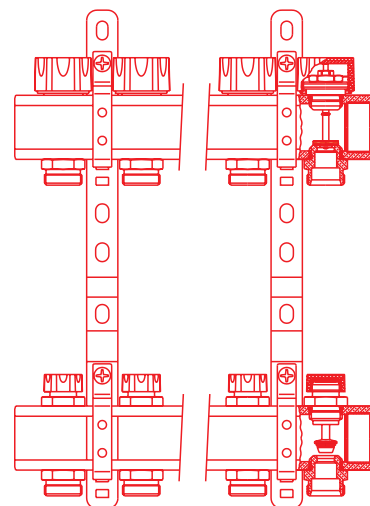
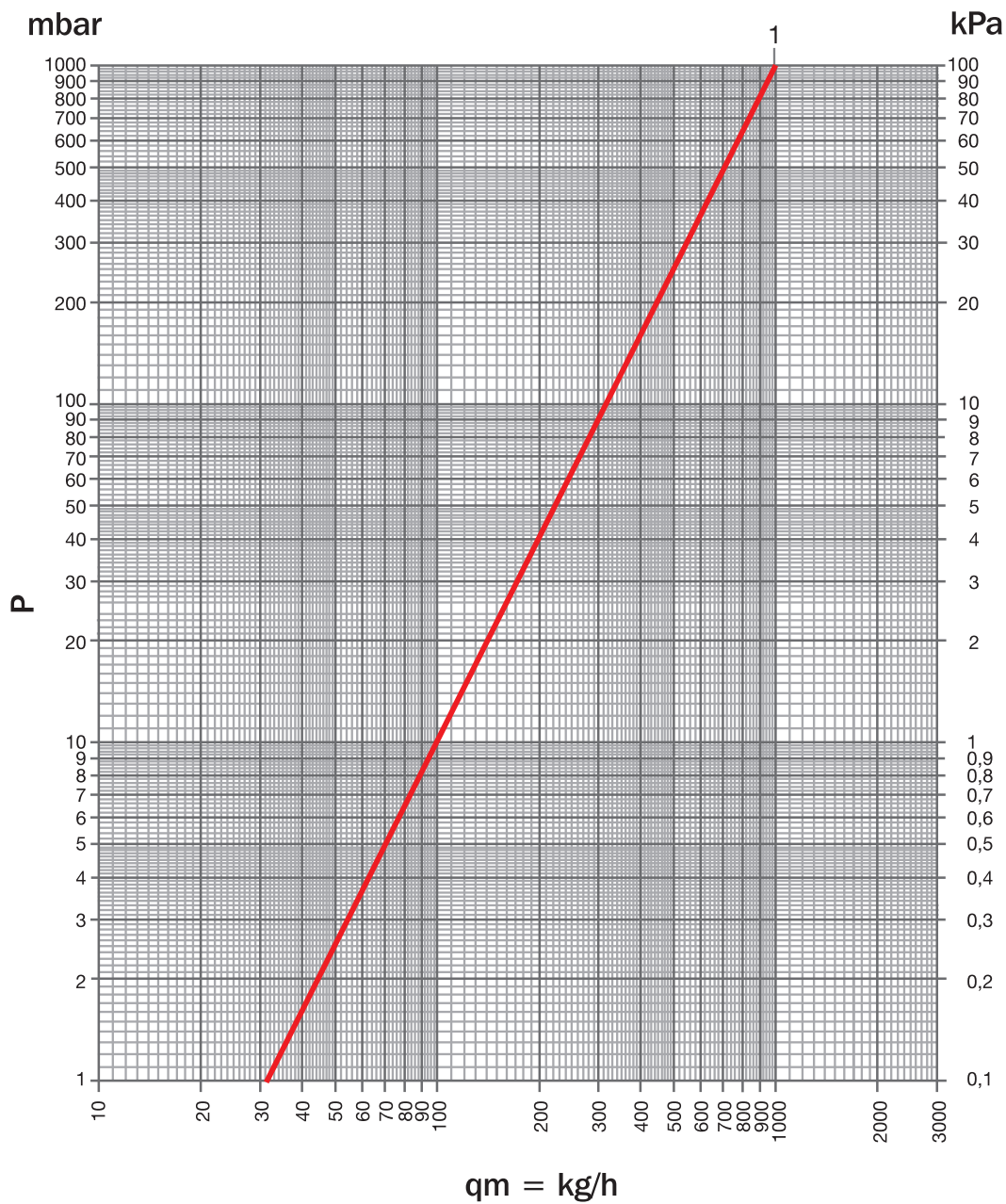

ARTICOLI	MISURA	CD + TM	FORO DI SCARICO	Kvs	POS
CD 2478 - CD 2473	G 1"	TM 4012	NO	0,99	1
CD 2878 - CD 2873	G 1"1/4				
CD 2479 - CD 2477	G 1"		SI		
CD 2879 - CD 2877	G 1"1/4		NO		
CD 478 - CD 473	G 1"				
CD 1878 - CD 1873	G 1"1/4		SI		
CD 479 - CD 477	G 1"				
CD 1879 - CD 1877	G 1"1/4				

MAX PORTATA CONSIGLIATA	
G 1"	1350 l/h
G 1"1/4	3150 l/h

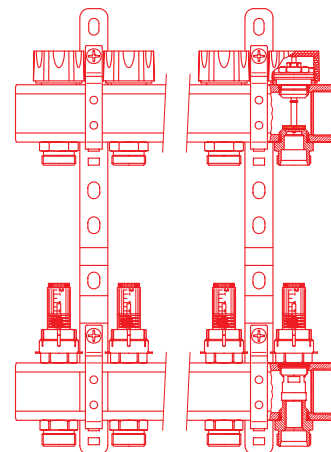



LUXOR®

COLLETTORI DI DISTRIBUZIONE IN ACCIAIO INOX

2.5 / SERIE CX

CX

COLLETTORI DI DISTRIBUZIONE IN ACCIAIO INOX



Sui collettori di nostra produzione utilizzare solo accessori Luxor che abbiano una tenuta morbida con guarnizione. Tutta la raccorderia e gli accessori dei collettori (valvole di scarico, terminali, tappi, ecc) sono dotati di tale tenuta e non necessitano di alcun elemento intermedio di sigillatura

(come ptfе, canapa, ecc) il cui utilizzo potrebbe causare l'insorgere di cricche.

Si consiglia di serrare la raccorderia ad una coppia massima di 60 Nm.

CARATTERISTICHE TECNICHE

Max temperatura	Max pressione	Materiale	Manopola	Asta di comando	Collaudo
120 °C	10 bar	AISI 304	ABS bianco RAL 9016	AISI 316	100%

ATTACCHI IMPIANTO



Tubo rame
W 24x19 - TR 91
G 3/4 EK - TR 91/A

CARATTERISTICHE TECNICHE CON REGOLATORI MISURATORI DI PORTATA ART. TM 4014

Max temperatura	Max pressione	Temperatura fluido	Temperatura ambiente	Max umidità relativa
65 °C	6 bar	0 °C ÷ 100 °C	0 °C ÷ 60 °C	80%

CARATTERISTICHE TECNICHE CON TESTE TERMoeLETRICHE ART. TE



Tubo plastica
W 24x19 - TP 95
G 3/4 EK - TP 98

ATTACCO CORPO PRINCIPALE



G 1"

INTERASSI

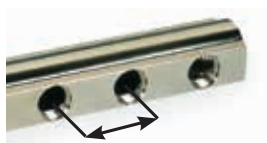

G 1" 50 mm



Tubo multistrato
W 24x19 - TP 97
G 3/4 EK - TP 99

REGOLATORI E MISURATORI DI PORTATA



I collettori di regolazione e bilanciamento, con regolatori e misuratori di portata TM 4014, danno la possibilità di una immediata verifica del bilanciamento dell'impianto attraverso la lettura della portata. La regolazione può essere bloccata tramite un coperchio d'arresto. Il bicchiere e la molla di misurazione possono essere smontati e puliti con l'impianto in funzione. Questo collettore deve essere installato sulla mandata.

DETTENTORI



I collettori di regolazione e bilanciamento (tipo detentore) sono dotati di regolazione micrometrica e predisposti per la memoria di posizione nel caso di chiusura momentanea e possono essere montati indifferentemente sia sulle mandate sia sui ritorni dei circuiti.



VITONE TERMOSTATIZZABILE

L'organo di tenuta sullo stelo dei collettori con valvole incorporate predisposte per la regolazione elettrotermica è ispezionabile e sostituibile anche con impianto in funzione. L'asta di comando è in acciaio inossidabile AISI 316 con una tenuta garantita da due guarnizioni o-ring in EPDM perossidico.

Tutti i collettori serie CX vengono testati al 100% con prova di tenuta pneumatica a controllo elettronico.

Le caratteristiche del fluido dell'impianto devono essere conformi alla direttiva UNI 8065:2019.

COLLETTORI DI DISTRIBUZIONE PER RISCALDAMENTO CON REGOLATORI E MISURATORI DI PORTATA IN MANDATA

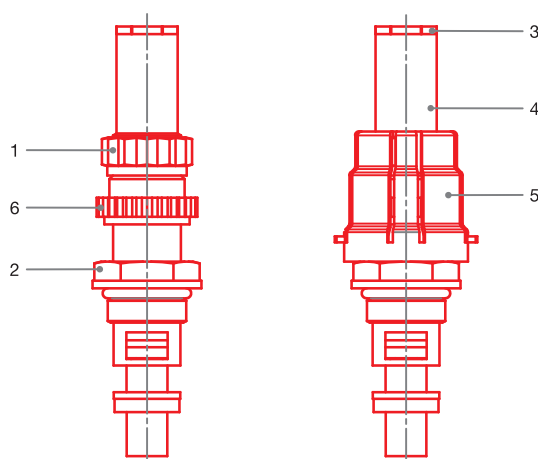

1. Ghiera di regolazione
2. Ghiera di fissaggio
3. Ghiera del bicchiere
4. Bicchiere
5. Coperchio d'arresto
6. Ghiera di memoria

ISTRUZIONI DI REGOLAZIONE COLLETTORI CON REGOLATORI MISURATORI DI PORTATA IN MANDATA

BILANCIAMENTO DEI CIRCUITI IDRAULICI

Il valore della portata teorica di un circuito idraulico, stabilito dal tecnico, è determinato dalla regolazione effettuata tramite i regolatori e misuratori di portata TM 4014 cod. 69000018 posizionati sulla mandata del circuito.

La regolazione deve avvenire con la valvola posta sul ritorno completamente aperta.

Dato che le portate di ciascun anello si influenzano tra loro, è importante che le regolazioni siano effettuate per ogni anello fino all'effettivo raggiungimento dei valori di portata in l/min stabiliti dal progetto.

FUNZIONE "MEMORY -STOP" FLUSSIMETRO

Sistema di bloccaggio del grado di apertura del flussimetro che consente, alla riapertura del circuito, l'arresto della corsa nella impostazione iniziale (valore di progetto).

- 1) Impostare la regolazione del Flussimetro a valore di progetto. Il volantino, durante questa operazione, deve essere tolto;
- 2) Avvitare la ghiera di "Memory-Stop" in senso antiorario (filettatura sinistra) fino ad arrivare a fine corsa;
- 3) Riposizionare il volantino. Agendo sul volantino (ruotando in senso orario) è possibile chiudere il singolo circuito. Ruotando in senso contrario fino al suo bloccaggio, è possibile riaprire il circuito, fino a valore di progetto impostato.

Tramite le due asole presenti sul volantino è possibile piombare il Flussimetro, onde evitarne la manomissione della regolazione impostata.

Attenzione: NON utilizzare attrezzi per la manovra/regolazione del Flussimetro, onde pregiudicarne il corretto funzionamento del Flussimetro stesso.

PULIZIA

Il bicchiere e la molla di misurazione possono essere smontati per la manutenzione e puliti anche con l'impianto in funzione. Per effettuare l'operazione:

- chiudere il Top meter e il vitone posto sul collettore di ritorno
- svitare il bicchiere facendo forza sulla ghiera dello stesso e toglierlo. Attenzione a non perdere la molla di misurazione
- risulterà una leggera, ma trascurabile, perdita durante l'operazione
- il bicchiere ora può essere, se necessario, pulito senza difficoltà
- il rimontaggio si effettua invertendo le operazioni.

PERDITE DI CARICO

La perdita di carico totale per circuito di riscaldamento si compone di varie perdite di carico: valvola di ritorno, tubi e regolatore misuratore di portata.

FLUSSIMETRO TM 4014 0,5 L

ΔP Pa	ΔP Kpa	Q l/h
10	0,01	8
100	0,1	25
500	0,5	60
1000	1	82
5000	5	185
10000	10	260
20000	20	365
30000	30	450
40000	40	520
50000	50	585
60000	60	640
70000	70	690
80000	80	740
90000	90	785
100000	100	825

CARATTERISTICHE FLUIDODINAMICHE

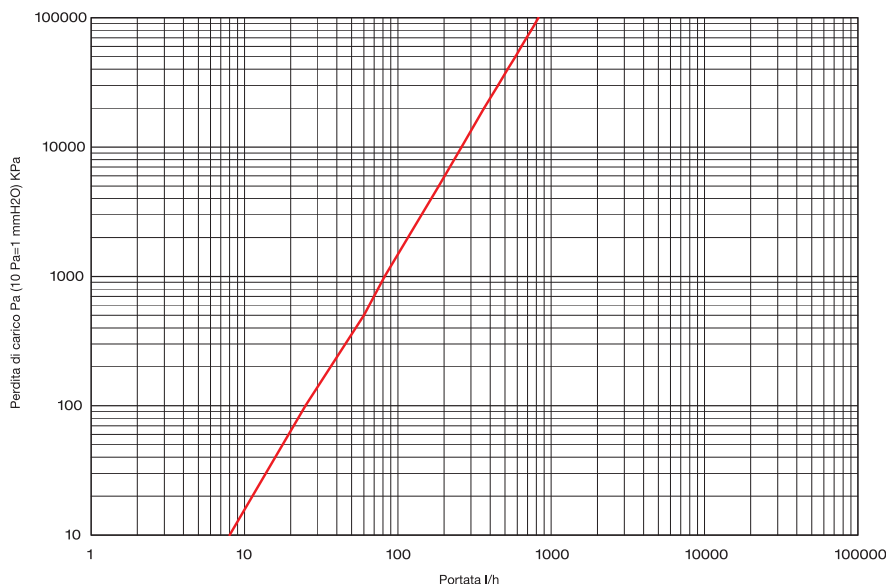

COLLETTORI DI DISTRIBUZIONE PER RISCALDAMENTO CON DETENTORI INCORPORATI

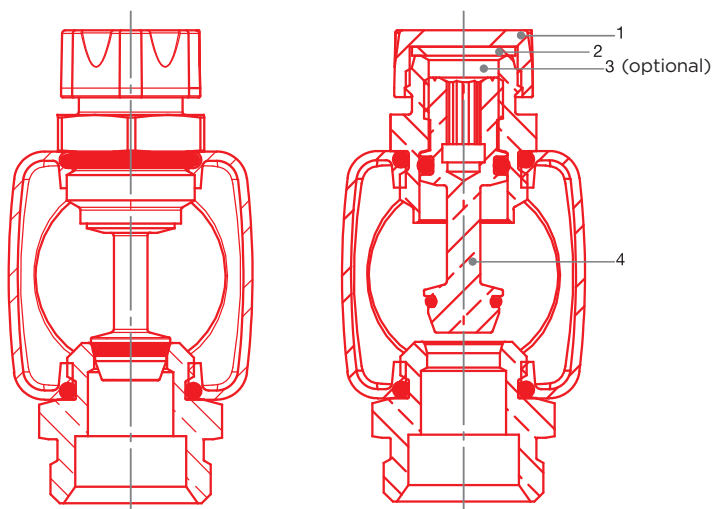

1. Tappo in ABS

2. Guarnizione di tenuta

3. Ghiera di regolazione cod. 3346656

4. Otturatore

ISTRUZIONI DI REGOLAZIONE DEI COLLETTORI CON DETENTORI

Svitare il tappo (1). Con la chiave a brugola avvitare l'otturatore fino a raggiungere la posizione di chiusura.

Dopo queste operazioni, il detentore è pronto per essere settato.

Sul diagramma di pressione differenziale è descritta la relazione tra valore di Kv, la posizione dell'otturatore e la corrispondente curva. Questo significa che, se si svita l'otturatore di un determinato numero di giri, si otterrà il Kv desiderato.

ESEMPIO

- Curva n. 1: 1/2 giri della vite - Kv = 0,09

- Curva n. 3: 1+1/2 giri della vite - Kv = 0,76

Utilizzando la ghiera (fornita a parte) cod. 3346656 è possibile creare un fine corsa meccanico all'otturatore.

Una volta impostata la portata desiderata tramite l'otturatore, la ghiera di regolazione deve essere avvitata in battuta contro l'otturatore.

Ora è possibile chiudere e riaprire l'otturatore senza perdere la posizione di regolazione impostata precedentemente.

In caso di perdite o trafiletti di acqua dall'asta del vitone termostattizzabile, si può agire serrando l'assemblato di tenuta fino alla cessazione della stessa. Se la perdita non dovesse terminare, si può sostituire il completo assemblato di tenuta del vitone con il gruppo in funzione eseguendo le operazioni sotto elencate.

- Togliere il cappuccio di protezione o il volantino manuale, o la testa termostatica o la testa termoelettrica;
- Svitare l'assemblato di tenuta con una chiave 9 mm bloccando il corpo vitone con una chiave da 19 mm;
- Sostituire l'assemblato di tenuta con l'accessorio di ricambio cod.: 67980200 avvitandolo con una chiave 9 mm;
- Riposizionare il cappuccio di protezione o il volantino manuale o la testa termostatica o la testa termoelettrica.

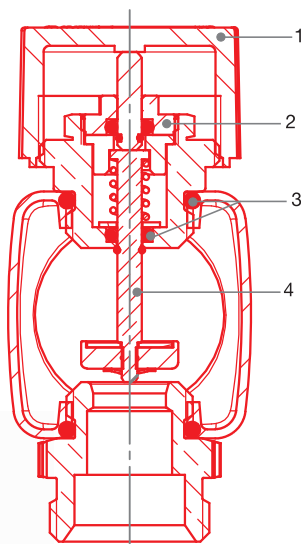

1. Tappo o volantino manuale in ABS

2. Assemblato di tenuta art.516

3. Guarnizione di tenuta

4. Otturatore



G 1"

SCHEMA PER SELEZIONARE LA CASSETTA CORRETTA

COLLETTORI DA G 1"

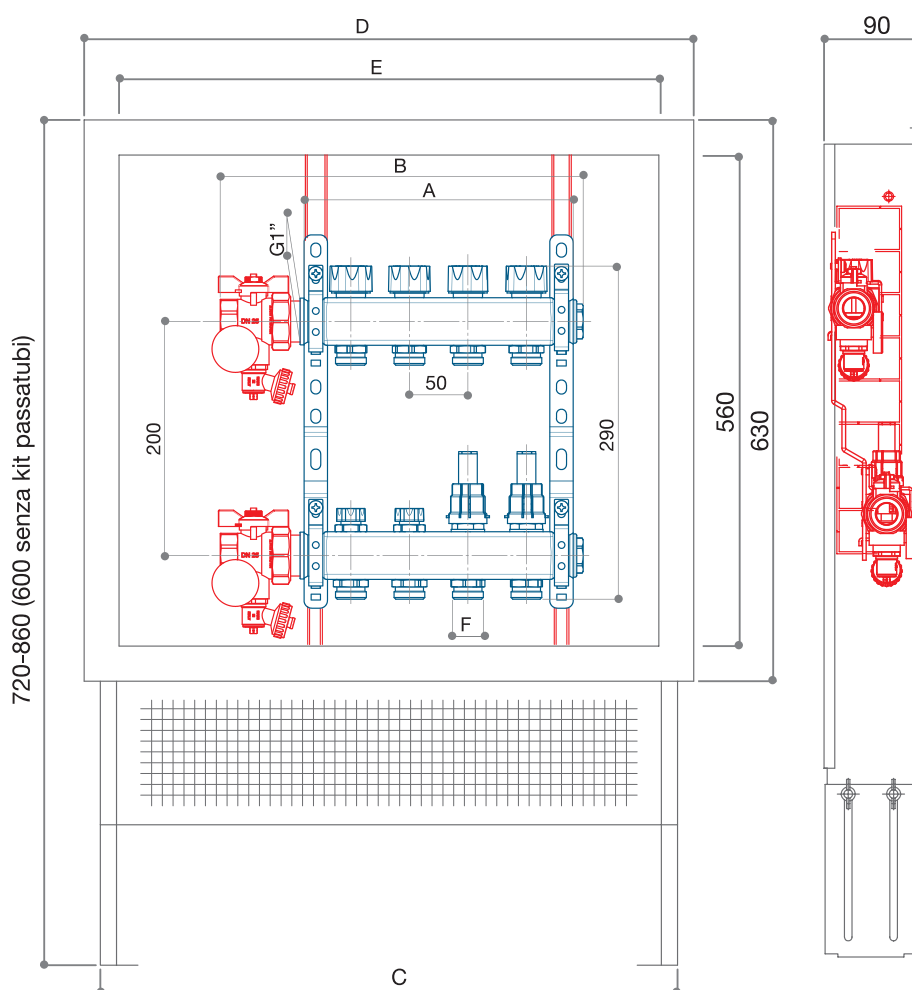

							CASSETTE	
VIE	A	B	C	D	E	F	ART.	COD.
2	130	210						
3	180	260						
4	230	310	500	560	490		CF 490	68561405
5	280	360						
6	330	410						
7	380	460						
8	430	510	700	760	690	W24x19 - G 3/4 EK	CF 490	68561407
9	480	560						
10	530	610						
11	580	660						
12	630	710	850	910	840		CF 490	68561408
13	680	760						
14	730	810						
15	780	860	1000	1060	990		CF 490	68561410
16	830	910						

COLLETTORI DI DISTRIBUZIONE IN ACCIAIO INOX

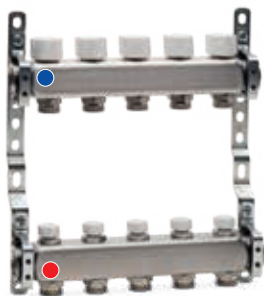

Collettore di distribuzione composto da:

- 1 collettore di ritorno con valvole incorporate predisposte per la regolazione elettrotermica e con cappucci di protezione
- 1 collettore di andata con detentori incorporati predisposto per la doppia regolazione
- 2 supporti metallici.

CX 2465

COD.	MISURA	N. VIE						
15512402X	G 1" x (W24x19)	2	TR 91	TP 95	TP 97	1,331	1	-
15512403X		3	TR 91	TP 95	TP 97	1,756	1	-
15512404X		4	TR 91	TP 95	TP 97	2,166	1	-
15512405X		5	TR 91	TP 95	TP 97	2,552	1	-
15512406X		6	TR 91	TP 95	TP 97	2,998	1	-
15512407X		7	TR 91	TP 95	TP 97	3,384	1	-
15512408X		8	TR 91	TP 95	TP 97	3,782	1	-
15512409X		9	TR 91	TP 95	TP 97	4,108	1	-
15512410X		10	TR 91	TP 95	TP 97	4,602	1	-
15512411X		11	TR 91	TP 95	TP 97	5,008	1	-
15512412X		12	TR 91	TP 95	TP 97	5,438	1	-
15512413X		13	TR 91	TP 95	TP 97	5,832	1	-
15512414X		14	TR 91	TP 95	TP 97	5,914	1	-
15512415X		15	TR 91	TP 95	TP 97	6,303	1	-
15512416X		16	TR 91	TP 95	TP 97	6,692	1	-

CX 2468

COD.	MISURA	N. VIE						
15512702X	G 1" x G 3/4 EK	2	TR 91/A	TP 98	TP 99	1,138	1	-
15512703X		3	TR 91/A	TP 98	TP 99	1,756	1	-
15512704X		4	TR 91/A	TP 98	TP 99	2,166	1	-
15512705X		5	TR 91/A	TP 98	TP 99	2,552	1	-
15512706X		6	TR 91/A	TP 98	TP 99	2,998	1	-
15512707X		7	TR 91/A	TP 98	TP 99	3,384	1	-
15512708X		8	TR 91/A	TP 98	TP 99	3,782	1	-
15512709X		9	TR 91/A	TP 98	TP 99	4,108	1	-
15512710X		10	TR 91/A	TP 98	TP 99	4,602	1	-
15512711X		11	TR 91/A	TP 98	TP 99	5,008	1	-
15512712X		12	TR 91/A	TP 98	TP 99	5,438	1	-
15512713X		13	TR 91/A	TP 98	TP 99	5,832	1	-
15512714X		14	TR 91/A	TP 98	TP 99	6,306	1	-
15512715X		15	TR 91/A	TP 98	TP 99	6,723	1	-
15512716X		16	TR 91/A	TP 98	TP 99	7,140	1	-



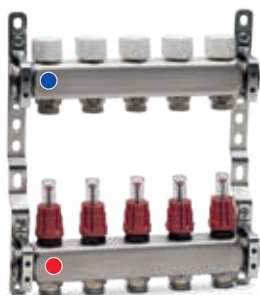

Collettore di distribuzione premontato composto da:

- 1 collettore di ritorno con valvole incorporate predisposte per la regolazione elettrotermica e con cappucci di protezione
- 1 collettore di andata con regolatori misuratori di portata
- 2 supporti metallici.

CX 2478

COD.	MISURA	N. VIE						
15612402X	G 1" x (W24x19)	2	TR 91	TP 95	TP 97	1,276	1	-
15612403X		3	TR 91	TP 95	TP 97	1,666	1	-
15612404X		4	TR 91	TP 95	TP 97	2,040	1	-
15612405X		5	TR 91	TP 95	TP 97	2,412	1	-
15612406X		6	TR 91	TP 95	TP 97	2,804	1	-
15612407X		7	TR 91	TP 95	TP 97	3,160	1	-
15612408X		8	TR 91	TP 95	TP 97	3,528	1	-
15612409X		9	TR 91	TP 95	TP 97	3,856	1	-
15612410X		10	TR 91	TP 95	TP 97	4,280	1	-
15612411X		11	TR 91	TP 95	TP 97	4,652	1	-
15612412X		12	TR 91	TP 95	TP 97	5,042	1	-
15612413X		13	TR 91	TP 95	TP 97	5,424	1	-
15612414X		14	TR 91	TP 95	TP 97	5,525	1	-
15612415X		15	TR 91	TP 95	TP 97	5,886	1	-
15612416X		16	TR 91	TP 95	TP 97	6,247	1	-

CX 2473

COD.	MISURA	N. VIE						
15612702X	G 1" x G 3/4 EK	2	TR 91/A	TP 98	TP 99	1,082	1	-
15612703X		3	TR 91/A	TP 98	TP 99	1,666	1	-
15612704X		4	TR 91/A	TP 98	TP 99	2,040	1	-
15612705X		5	TR 91/A	TP 98	TP 99	2,412	1	-
15612706X		6	TR 91/A	TP 98	TP 99	2,804	1	-
15612707X		7	TR 91/A	TP 98	TP 99	3,160	1	-
15612708X		8	TR 91/A	TP 98	TP 99	3,528	1	-
15612709X		9	TR 91/A	TP 98	TP 99	3,856	1	-
15612710X		10	TR 91/A	TP 98	TP 99	4,280	1	-
15612711X		11	TR 91/A	TP 98	TP 99	4,652	1	-
15612712X		12	TR 91/A	TP 98	TP 99	5,042	1	-
15612713X		13	TR 91/A	TP 98	TP 99	5,424	1	-
15612714X		14	TR 91/A	TP 98	TP 99	5,917	1	-
15612715X		15	TR 91/A	TP 98	TP 99	6,306	1	-
15612716X		16	TR 91/A	TP 98	TP 99	6,695	1	-



Raccordi per tubo rame



Raccordi per tubo plastica



Raccordi per tubo multistrato



Raccordi: capitolo 7





Accessori: capitolo 2.A



Collettore di distribuzione premontato composto da:

- 1 collettore di ritorno con vitone manuale con dischetti in alluminio per identificazione utenze sanitarie
- 1 collettore di mandata con vitone manuale con dischetti in alluminio per identificazione utenze sanitarie
- 2 supporti metallici.

CX 1000



COD.	MISURA	N. VIE						
15712702X	G 1" x G 3/4 EK	2	TR 91/A	TP 98	TP 99	1,3328	1	-
15712703X		3	TR 91/A	TP 98	TP 99	1,7232	1	-
15712704X		4	TR 91/A	TP 98	TP 99	2,1096	1	-
15712705X		5	TR 91/A	TP 98	TP 99	2,4760	1	-
15712706X		6	TR 91/A	TP 98	TP 99	2,8824	1	-
15712707X		7	TR 91/A	TP 98	TP 99	3,2448	1	-
15712708X		8	TR 91/A	TP 98	TP 99	3,6632	1	-
15712709X		9	TR 91/A	TP 98	TP 99	4,0956	1	-
15712710X		10	TR 91/A	TP 98	TP 99	4,4560	1	-
15712711X		11	TR 91/A	TP 98	TP 99	4,8424	1	-
15712712X		12	TR 91/A	TP 98	TP 99	5,2248	1	-
15712713X		13	TR 91/A	TP 98	TP 99	5,6212	1	-
15712714X		14	TR 91/A	TP 98	TP 99	6,0176	1	-





Collettore di distribuzione premontato con vitone manuale con dischetti in alluminio per identificazione utenze sanitarie. Valvola manuale di sfiato aria e valvola di carico/scarico acqua impianto di riscaldamento.

CX 4123

COD.	MISURA	N. VIE			
17412302X	G 1" x G 3/4 EK	2	0,6394	15	-
17412303X		3	0,8326	12	-
17412304X		4	1,0158	10	-
17412305X		5	1,2190	10	-
17412306X		6	1,4002	8	-
17412307X		7	1,6094	8	-
17412308X		8	1,8256	8	-
17412309X		9	2,0058	8	-
17412310X		10	2,1990	8	-
17412311X		11	2,3902	8	-
17412312X		12	2,5884	8	-



COLLETTORI DI DISTRIBUZIONE IN ACCIAIO INOX PREMONTATI CON ACCESSORI DI INSTALLAZIONE

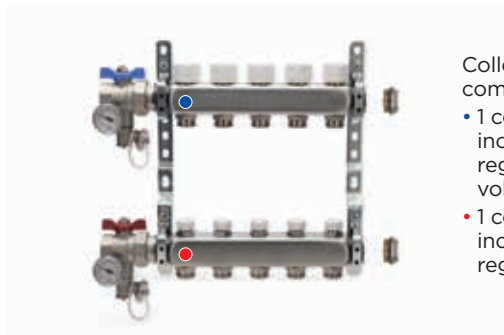

Collettore di distribuzione premontato composto da:

- 1 collettore di ritorno con valvole incorporate predisposte per la regolazione elettrotermica e con volantino di comando manuale
- 1 collettore di andata con detentori incorporati predisposto per la doppia regolazione.

CX 2465M

COD.	MISURA	N. VIE						
15512402MX	G 1" x (W24x19)	2	TR 91	TP 95	TP 97	2,658	1	-
15512403MX		3	TR 91	TP 95	TP 97	3,276	1	-
15512404MX		4	TR 91	TP 95	TP 97	3,686	1	-
15512405MX		5	TR 91	TP 95	TP 97	4,072	1	-
15512406MX		6	TR 91	TP 95	TP 97	4,518	1	-
15512407MX		7	TR 91	TP 95	TP 97	4,904	1	-
15512408MX		8	TR 91	TP 95	TP 97	5,302	1	-
15512409MX		9	TR 91	TP 95	TP 97	5,628	1	-
15512410MX		10	TR 91	TP 95	TP 97	6,122	1	-
15512411MX		11	TR 91	TP 95	TP 97	6,528	1	-
15512412MX		12	TR 91	TP 95	TP 97	6,958	1	-
15512413MX		13	TR 91	TP 95	TP 97	7,352	1	-
15512414MX		14	TR 91	TP 95	TP 97	7,313	1	-
15512415MX		15	TR 91	TP 95	TP 97	7,702	1	-
15512416MX		16	TR 91	TP 95	TP 97	8,090	1	-

CX 2468M

COD.	MISURA	N. VIE						
15512702MX	G 1" x G 3/4 EK	2	TR 91/A	TP 98	TP 99	2,658	1	-
15512703MX		3	TR 91/A	TP 98	TP 99	3,276	1	-
15512704MX		4	TR 91/A	TP 98	TP 99	3,686	1	-
15512705MX		5	TR 91/A	TP 98	TP 99	4,072	1	-
15512706MX		6	TR 91/A	TP 98	TP 99	4,518	1	-
15512707MX		7	TR 91/A	TP 98	TP 99	4,904	1	-
15512708MX		8	TR 91/A	TP 98	TP 99	5,302	1	-
15512709MX		9	TR 91/A	TP 98	TP 99	5,628	1	-
15512710MX		10	TR 91/A	TP 98	TP 99	6,122	1	-
15512711MX		11	TR 91/A	TP 98	TP 99	6,528	1	-
15512712MX		12	TR 91/A	TP 98	TP 99	6,958	1	-
15512713MX		13	TR 91/A	TP 98	TP 99	7,352	1	-
15512714MX		14	TR 91/A	TP 98	TP 99	7,705	1	-
15512715MX		15	TR 91/A	TP 98	TP 99	8,122	1	-
15512716 MX		16	TR 91/A	TP 98	TP 99	8,538	1	-



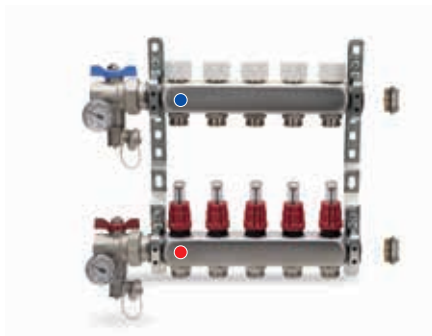

Collettore di distribuzione premontato composto da:

- 1 collettore di ritorno con valvole incorporate predisposte per la regolazione elettrotermica e con volantino di comando manuale
- 1 collettore di andata con regolatori e misuratori di portata.

CX 2478M

COD.	MISURA	N. VIE						
15612402MX	G 1" x (W24x19)	2	TR 91	TP 95	TP 97	2,602	1	-
15612403MX		3	TR 91	TP 95	TP 97	3,186	1	-
15612404MX		4	TR 91	TP 95	TP 97	3,560	1	-
15612405MX		5	TR 91	TP 95	TP 97	3,932	1	-
15612406MX		6	TR 91	TP 95	TP 97	4,324	1	-
15612407MX		7	TR 91	TP 95	TP 97	4,680	1	-
15612408MX		8	TR 91	TP 95	TP 97	5,048	1	-
15612409MX		9	TR 91	TP 95	TP 97	5,376	1	-
15612410MX		10	TR 91	TP 95	TP 97	5,800	1	-
15612411MX		11	TR 91	TP 95	TP 97	6,172	1	-
15612412MX		12	TR 91	TP 95	TP 97	6,562	1	-
15612413MX		13	TR 91	TP 95	TP 97	6,944	1	-
15612414MX		14	TR 91	TP 95	TP 97	6,924	1	-
15612415MX		15	TR 91	TP 95	TP 97	7,285	1	-
15612416MX		16	TR 91	TP 95	TP 97	7,646	1	-

CX 2473M

COD.	MISURA	N. VIE						
15612702MX	G 1" x G 3/4 EK	2	TR 91/A	TP 98	TP 99	2,602	1	-
15612703MX		3	TR 91/A	TP 98	TP 99	3,186	1	-
15612704MX		4	TR 91/A	TP 98	TP 99	3,560	1	-
15612705MX		5	TR 91/A	TP 98	TP 99	3,932	1	-
15612706MX		6	TR 91/A	TP 98	TP 99	4,324	1	-
15612707MX		7	TR 91/A	TP 98	TP 99	4,680	1	-
15612708MX		8	TR 91/A	TP 98	TP 99	5,048	1	-
15612709MX		9	TR 91/A	TP 98	TP 99	5,376	1	-
15612710MX		10	TR 91/A	TP 98	TP 99	5,800	1	-
15612711MX		11	TR 91/A	TP 98	TP 99	6,172	1	-
15612712MX		12	TR 91/A	TP 98	TP 99	6,562	1	-
15612713MX		13	TR 91/A	TP 98	TP 99	6,944	1	-
15612714MX		14	TR 91/A	TP 98	TP 99	7,316	1	-
15612715MX		15	TR 91/A	TP 98	TP 99	7,705	1	-
15612716MX		16	TR 91/A	TP 98	TP 99	8,094	1	-



Raccordi per tubo rame



Raccordi per tubo plastica



Raccordi per tubo multistrato



Raccordi: capitolo 7



Accessori: capitolo 2.A

VALVOLA A SFERA MULTIFUNZIONE



CARATTERISTICHE TECNICHE



Max temperatura
90°C



Max pressione
10 bar



DN
25



Materiale
CW617N

CARATTERISTICHE COSTRUTTIVE

Le valvole a sfera multifunzione vengono prodotte in ottone CW617N e sono compatibili con i collettori e con gli altri componenti prodotti da Luxor.

Le valvole a sfera multifunzione hanno il perno di manovra montato dall'interno. Questo sistema è chiamato "antiscoppio" perché offre maggiori garanzie contro la fuoriuscita accidentale del perno e del relativo sistema di tenuta e per l'impossibilità di essere manomesso dall'esterno. Le valvole a sfera presentano una doppia tenuta con anelli O-Ring in elastomero, scelto per l'elevata resistenza all'invecchiamento.

FUNZIONALITÀ

Le valvole a sfera multifunzione sono estremamente compatte e si possono installare sia sulla destra sia sulla sinistra del collettore semplicemente posizionando il termometro sul lato desiderato.

Esse vengono definite "multifunzione" perché racchiudono in un unico prodotto una serie di funzionalità:

- **Valvola carico/scarico acqua:** nella parte inferiore della valvola è presente un valvolino girevole per il carico/scarico dell'acqua, manovrabile tramite la chiave quadrata ricavata nel tappo di chiusura.
- **Valvola sfiato aria manuale:** nell'asta della maniglia è presente uno sfiato manuale per l'aria che si può manovrare sempre tramite la chiave ricavata nel tappo della valvola di carico/scarico acqua. La posizione dello scarico presente nella parte superiore della valvola permette un ottimo funzionamento agevolando la fuoriuscita di tutta l'aria presente nell'impianto.
- **Termometro integrato** per la visualizzazione della temperatura: può essere posizionato su entrambi i lati in base all'utilizzo.

VALVOLA A SFERA



VALVOLA CARICO / SCARICO ACQUA

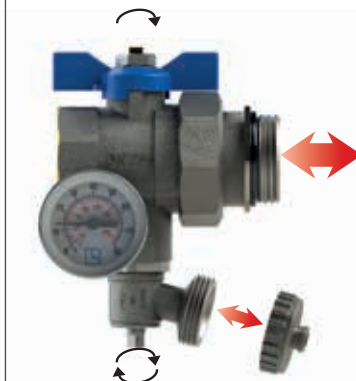

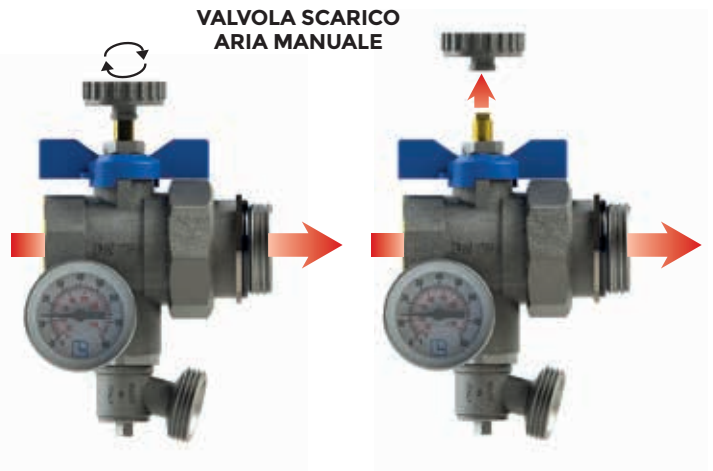

VALVOLA SCARICO ARIA MANUALE

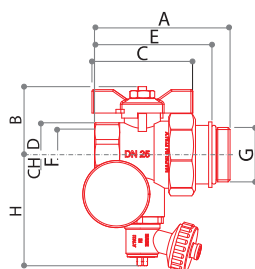

VALVOLE A SFERA MULTIFUNZIONE

**VC 481**

Valvola a sfera multifunzione con scarico aria manuale, carico acqua, maniglia a farfalla di colore di colore blu o rosso e raccordo art. CR 498 con o-ring per attacco al collettore completa di termometro scala 0 °C ÷ 80 °C.

CODICE	MISURA	A	B	C	D	E	F	G	H	L			
68559722B	G 1"	81	41	60	38	70	G 1"	G 1"	70	-	645	4	32
68559722R	G 1"	81	41	60	38	70	G 1"	G 1"	70	-	645	4	32

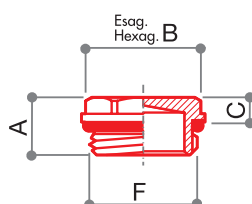
**TC 460**

Tappo cieco con guarnizione o-ring.



CODICE	MISURA	FINITURA	A	B	C	D	E	F	G	H	L			
68559934N	G 1"	NICHELATA	19	27	9	-	-	G 1"	-	-	-	52	50	400

DIAGRAMMA DI PORTATA COLLETTORI

COLLETTORI DI DISTRIBUZIONE CON DETENTORI INCORPORATI

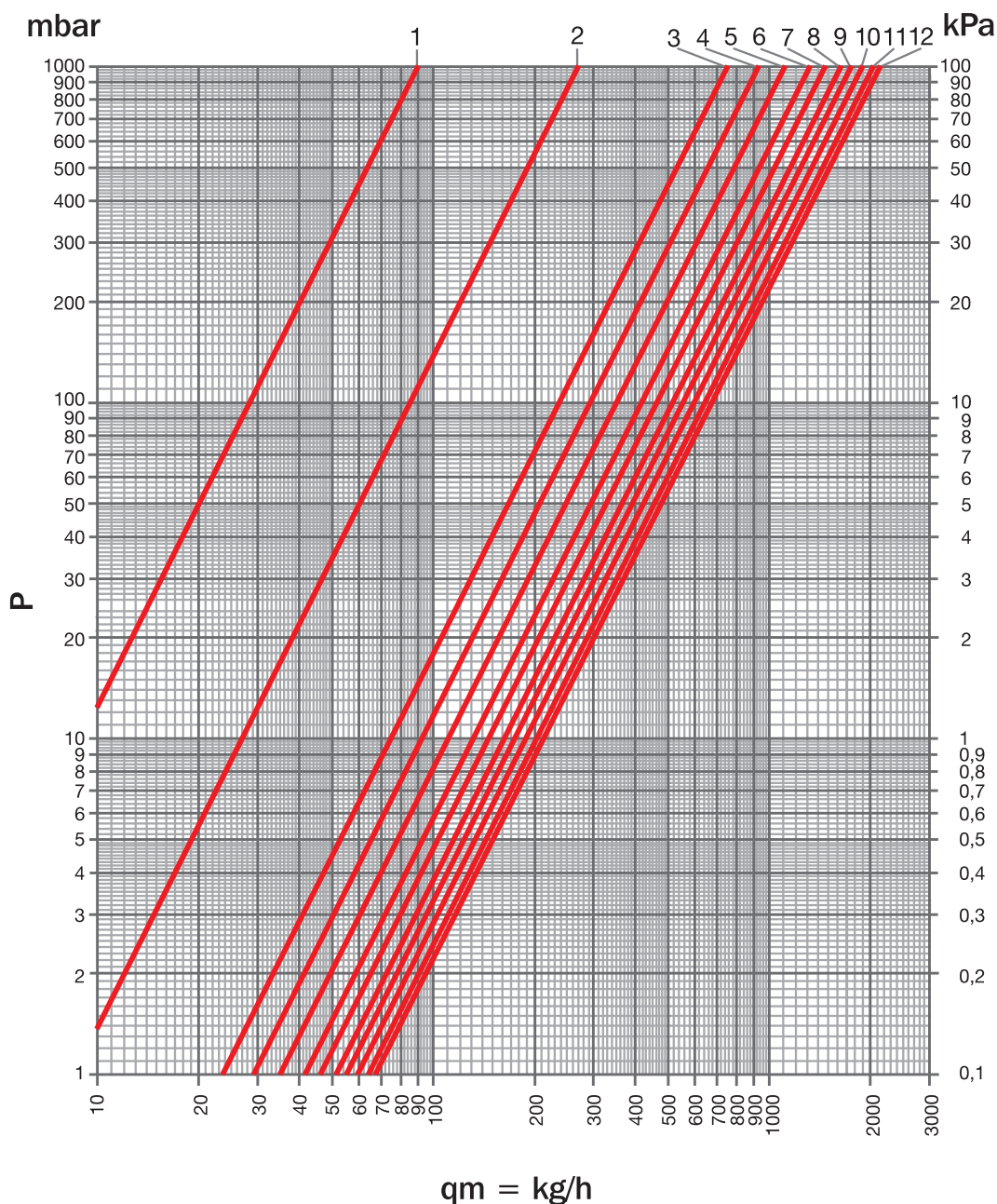

ARTICOLI	MISURA	N. GIRI	Kvs	POS
CX 2468	G 1"	1/2	0,09	1
		1	0,27	2
		1+1/2	0,75	3
		2	0,93	4
		2+1/2	1,11	5
		3	1,31	6
		3+1/2	1,48	7
		4	1,62	8
		4+1/2	1,76	9
		5	1,90	10
		5+1/2	2,02	11
		tutto aperto	2,12	12

MAX PORTATA CONSIGLIATA
2860 l/h



DIAGRAMMA DI PORTATA COLLETTORI

COLLETTORI DI DISTRIBUZIONE CON REGOLATORI DI PORTATA TM

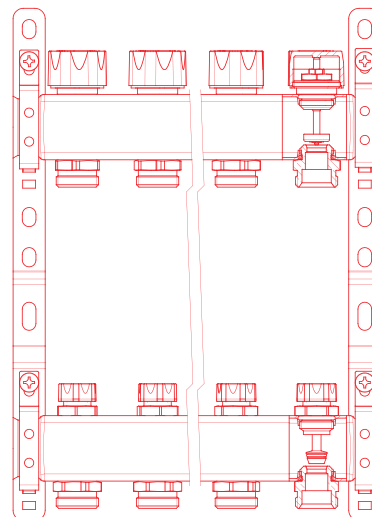
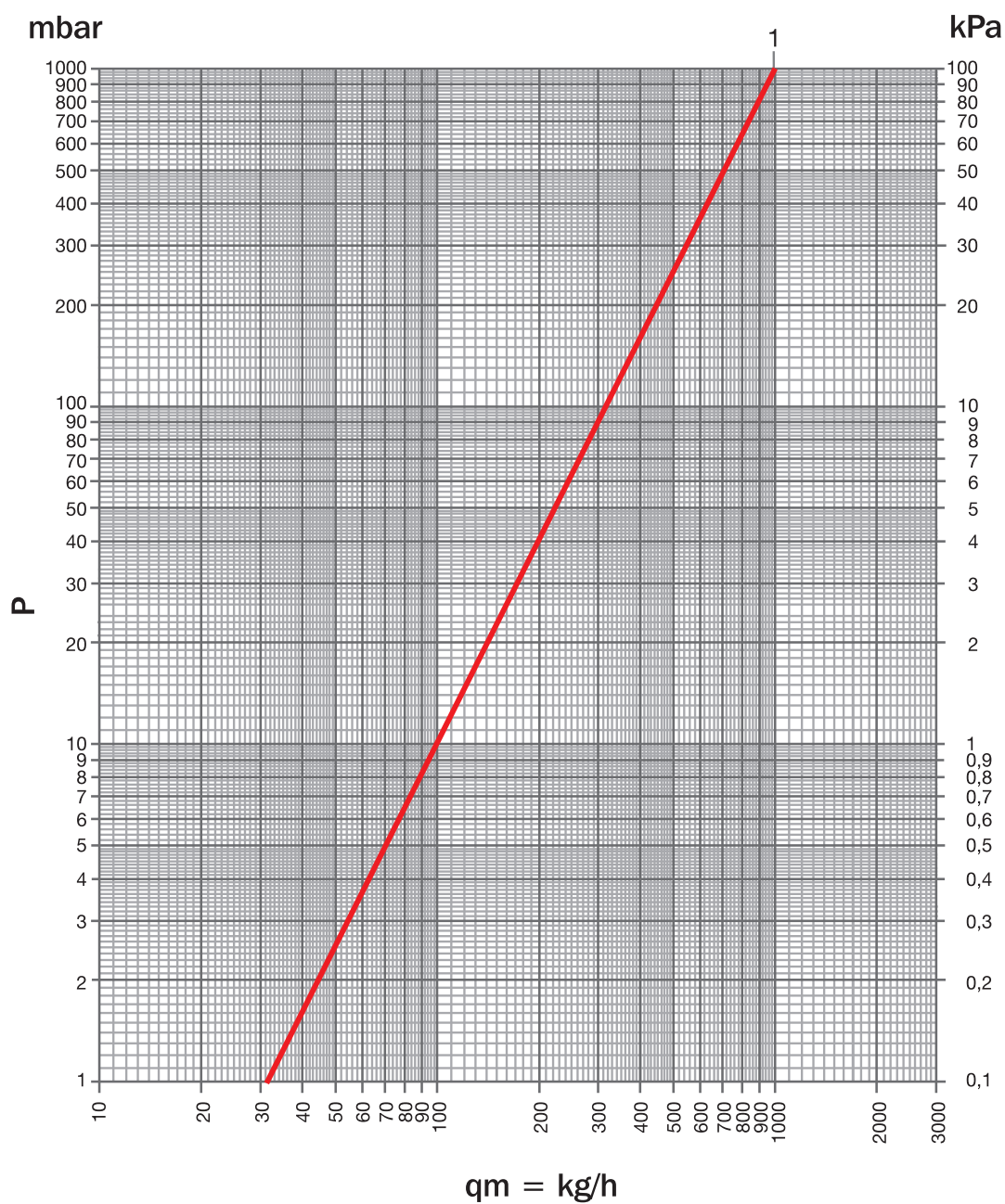

ARTICOLI	MISURA	CX + TM	Kvs	POS
CX 2473	G 1"	TM 4014	0,99	1

MAX PORTATA CONSIGLIATA
2450 l/h

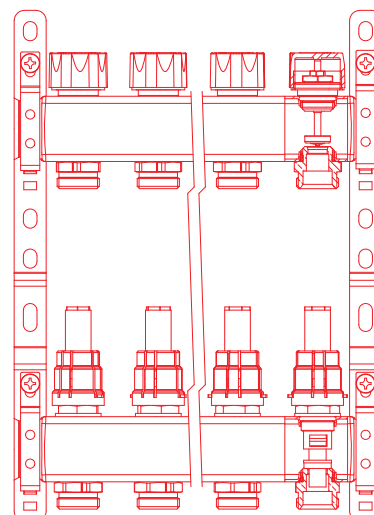



LUXOR®

COLLETTORI

2.A / ACCESSORI

TESTE TERMOSTATICHE

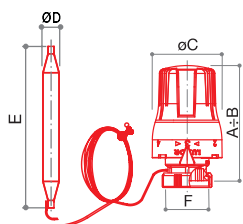
**TT 3051**

Testa termostatica per riscaldamento a pavimento con sonda a distanza. Campo di regolazione 20 °C÷65 °C. Lunghezza standard del capillare trasmettitore 2 m.

CODICE	MISURA	aperto		chiuso		E	F	G	H	L	🔧	📦	📦
		A	B	C	D								
69100005	M30x1,5	80	75	47	11	110	M30x1,5	-	-	-	146	1	32

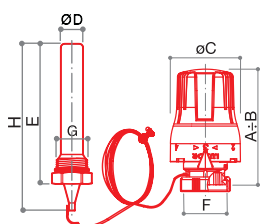
**TT 3061**

Testa termostatica per riscaldamento a pavimento con pozzetto da G1/2 M per sonda a distanza. Campo di regolazione 20° C÷65° C. Lunghezza standard del capillare trasmettitore 2 m.

CODICE	MISURA	aperto		chiuso		E	F	G	H	L	🔧	📦	📦
		A	B	C	D								
69100006	M30x1,5	80	75	47	15	95	M30x1,5	G 1/2	110	-	232	1	32

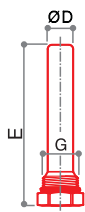
**PS 540**

Pozzetto per sonda.

CODICE	MISURA	A	B	C	D	E	F	G	H	L	🔧	📦	📦
9446950	G 1/2	-	-	-	15	95	-	G 1/2	-	-	92	20	160

**DT 242**

Dispositivo di fissaggio per sonda articolo TT 3051.

CODICE	MISURA	🔧	📦	📦
69010500	-	30	20	160

ACCESSORI PER COLLETTORI DI DISTRIBUZIONE

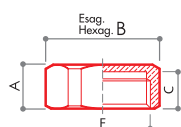
**TC 430**

Tappo di testa cieco con guarnizione in EPDM.



Conforme secondo il D.M. 174/2004

CODICE	MISURA	A	B	C	D	E	F	G	H	L			
68502701	G 3/4	13	30	11	-	-	G 3/4	-	-	-	37	100	800
68503401	G 1"	15	37	12	-	-	G 1"	-	-	-	60	50	400

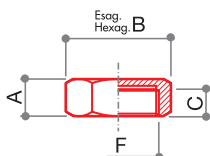
**TC 450**

Tappo laterale cieco con guarnizione piana di tenuta.

CODICE	MISURA	FINITURA	A	B	C	D	E	F	G	H	L			
68552419	(W24x19)	GIALLA	11	27	8	-	-	W24x19	-	-	-	25	100	800
68552419N	(W24x19)	NICHELATA	11	27	8	-	-	W24x19	-	-	-	25	100	800

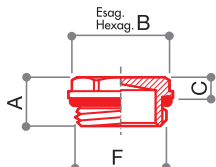
**TC 460**

Tappo cieco con guarnizione o-ring.

CODICE	MISURA	FINITURA	A	B	C	D	E	F	G	H	L			
68559917	G 3/8	GIALLA	13	20	8	-	-	G 3/8	-	-	-	20	200	1600
68559921	G 1/2	GIALLA	13	22	7	-	-	G 1/2	-	-	-	20	100	800
68559927	G 3/4	GIALLA	14	25	7	-	-	G 3/4	-	-	-	32	100	800
68559934	G 1"	GIALLA	19	27	9	-	-	G 1"	-	-	-	52	50	400
68559942	G 1" 1/4	GIALLA	25	38	12	-	-	G 1" 1/4	-	-	-	94	30	240
68559917N	G 3/8	NICHELATA	13	20	8	-	-	G 3/8	-	-	-	20	200	1600
68559921N	G 1/2	NICHELATA	13	22	7	-	-	G 1/2	-	-	-	20	100	800
68559927N	G 3/4	NICHELATA	14	25	7	-	-	G 3/4	-	-	-	32	100	800
68559934N	G 1"	NICHELATA	19	27	9	-	-	G 1"	-	-	-	52	50	400
68559942N	G 1" 1/4	NICHELATA	25	38	12	-	-	G 1" 1/4	-	-	-	94	30	240

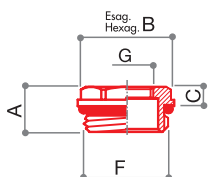
**TC 462**

Tappo con riduzione e con guarnizione di tenuta o-ring.

CODICE	MISURA	FINITURA	A	B	C	D	E	F	G	H	L			
68559901	G 3/4 x G 3/8	GIALLA	14	25	8	-	-	G 3/4	G 3/8	-	-	31	100	800
68559905	G 3/4 x G 1/2	GIALLA	14	25	8	-	-	G 3/4	G 1/2	-	-	23	100	800
68559902	G 1" x G 3/8	GIALLA	19	27	10	-	-	G 1"	G 3/8	-	-	60	50	400
68559903	G 1" x G 1/2	GIALLA	19	27	10	-	-	G 1"	G 1/2	-	-	56	50	400
68559904	G 1" x G 3/4	GIALLA	19	27	10	-	-	G 1"	G 3/4	-	-	58	50	400
68559908	G 1" 1/4 x G 1/2	GIALLA	24	38	11	-	-	G 1" 1/4	G 1/2	-	-	136	30	240
68559909	G 1" 1/4 x G 3/4	GIALLA	24	38	11	-	-	G 1" 1/4	G 3/4	-	-	116	30	240
68559910	G 1" 1/4 x G 1"	GIALLA	24	38	11	-	-	G 1" 1/4	G 1"	-	-	82	30	240
68559901N	G 3/4 x G 3/8	NICHELATA	14	25	8	-	-	G 3/4	G 3/8	-	-	31	100	800
68559905N	G 3/4 x G 1/2	NICHELATA	14	25	8	-	-	G 3/4	G 1/2	-	-	23	100	800
68559902N	G 1" x G 3/8	NICHELATA	19	27	10	-	-	G 1"	G 3/8	-	-	60	50	400
68559903N	G 1" x G 1/2	NICHELATA	19	27	10	-	-	G 1"	G 1/2	-	-	56	50	400
68559904N	G 1" x G 3/4	NICHELATA	19	27	10	-	-	G 1"	G 3/4	-	-	58	50	400
68559908N	G 1" 1/4 x G 1/2	NICHELATA	24	38	11	-	-	G 1" 1/4	G 1/2	-	-	136	30	240
68559909N	G 1" 1/4 x G 3/4	NICHELATA	24	38	11	-	-	G 1" 1/4	G 3/4	-	-	116	30	240
68559910N	G 1" 1/4 x G 1"	NICHELATA	24	38	11	-	-	G 1" 1/4	G 1"	-	-	82	30	240

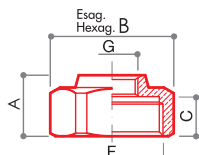

TC 435

Tappo di testa con riduzione.

CODICE	MISURA	A	B	C	D	E	F	G	H	L			
68502702	G 3/4 x G 3/8	17	31	11,5	-	-	G 3/4	G 3/8	-	-	50	100	800
68503402	G 1" x G 3/8	21	37	13	-	-	G 1"	G 3/8	-	-	66	50	400
68503406	G 1" x G 1/2	21	37	13	-	-	G 1"	G 1/2	-	-	64	50	400

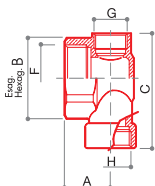

TC 440

Terminale con attacchi femmina.

CODICE	MISURA	A	B	C	D	E	F	G	H	L			
68502708	G 3/4xG 1/2xG 1/2	33	-	41	-	-	G 3/4	G 1/2	G 1/2	-	140	25	200
68503408	G 1"xG 3/8xG 1/2	23,5	37	58	-	-	G 1"	G 3/8	G 1/2	-	133	25	200

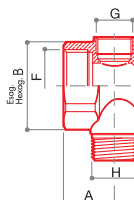

TC 445

Terminale con attacchi femmina da 3/8 (per valvola di scarico aria) e maschio da 1/2 (per valvole carico acqua).

CODICE	MISURA	A	B	C	D	E	F	G	H	L			
68502705	G 3/4	23,5	37	-	-	-	G 3/4	G 3/8	G 1/2	-	158	25	200
68503405	G 1"	23,5	37	-	-	-	G 1"	G 3/8	G 1/2	-	118	25	200

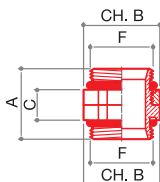

TC 465

Raccordo di unione M-M contro ghiera e con guarnizione di tenuta o-rings per collettori serie CD.

CODICE	MISURA	FINITURA	A	B	C	D	E	F	G	H	L			
68559635	G 1" x G 1"	GIALLA	37	37	16	-	-	G 1"	-	-	-	121	15	120
68559642	G 1"1/4 x G 1"1/4	GIALLA	45	48	20	-	-	G 1"1/4	-	-	-	245	10	80
68559635N	G 1" x G 1"	NICHELATA	37	37	16	-	-	G 1"	-	-	-	121	15	120
68559642N	G 1"1/4 x G 1"1/4	NICHELATA	45	48	20	-	-	G 1"1/4	-	-	-	245	10	80

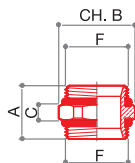



TC 464

Raccordo di unione M-M con guarnizioni o-ring.

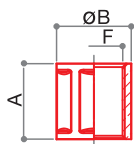
CODICE	MISURA	FINITURA	A	B	C	D	E	F	G	H	L			
68559827	G 3/4 x G 3/4	GIALLA	27	30	7	-	-	G 3/4	-	-	-	66	80	640
68559834	G 1" x G 1"	GIALLA	28	37	8	-	-	G 1"	-	-	-	85	50	400
68559842	G 1"1/4 x G 1"1/4	GIALLA	34	48	10	-	-	G 1"1/4	-	-	-	153	20	160
68559827N	G 3/4 x G 3/4	NICHELATA	27	30	7	-	-	G 3/4	-	-	-	66	80	640
68559834N	G 1" x G 1"	NICHELATA	28	37	8	-	-	G 1"	-	-	-	85	50	400
68559842N	G 1"1/4 x G 1"1/4	NICHELATA	34	48	10	-	-	G 1"1/4	-	-	-	153	20	160



**RD 901**

Manicotto di unione diretto F - F.

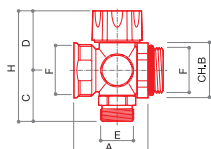
CODICE	MISURA	A	B	C	D	E	F	G	H	L			
7146770N	G 3/4	33	32	-	-	-	G 3/4	-	-	-	62	30	240
7146772N	G 1"	33	41	-	-	-	G 1"	-	-	-	93	20	160



**CD 1466/1**

Collettore a 1 partenza con valvola incorporata predisposta per la regolazione elettrotermica e con cappuccio di protezione.

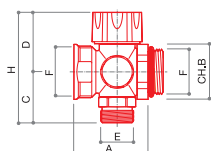
CODICE	MISURA	A	B	C	D	E	F	G	H	L			
15112401N	G 1" x (W24x19)	54	37	37	43	W24x19	G 1"	G 1/2	80	-	322	2	64



**CD 1446/1**

Collettore a 1 partenza con valvola incorporata predisposta per la regolazione elettrotermica e con cappuccio di protezione.

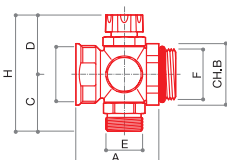
CODICE	MISURA	A	B	C	D	E	F	G	H	L			
15112701N	G 1" x G 3/4 EK	54	37	37	43	G 3/4 EK	G 1"	G 1/2	80	-	333	2	64



**CD 449/1**

Collettore a 1 partenza con detentore incorporato.

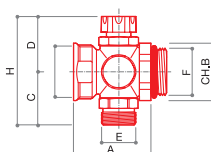
CODICE	MISURA	A	B	C	D	E	F	G	H	L			
15121401N	G 1" x (W24x19)	54	37	37	39	W24x19	G 1"	G 1/2	76	-	310	2	64



**CD 448/1**

Collettore a 1 partenza con detentore incorporato.

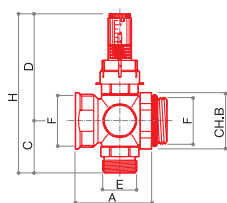
CODICE	MISURA	A	B	C	D	E	F	G	H	L			
15121701N	G 1" x G 3/4 EK	54	37	37	39	G 3/4 EK	G 1"	G 1/2	76	-	321	2	64



**CD 1474/1**

Collettore a 1 partenza con regolatore misuratore di portata.

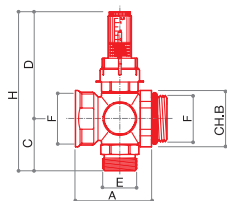
CODICE	MISURA	A	B	C	D	E	F	G	H	L			
15252401N	G 1" x (W24x19)	54	37	37	76	W24x19	G 1"	G 1/2	113	-	298	2	64

**CD 474/1**

Collettore a 1 partenza con regolatore misuratore di portata.



CODICE	MISURA	A	B	C	D	E	F	G	H	L			
15252701N	G 1" x G 3/4 EK	54	37	37	76	G 3/4 EK	G 1"	G 1/2	113	-	326	2	64

**KC 650**

Kit per collettori serie CD composto da:

- n. 1 valvola a sfera ad angolo con maniglia a farfalla di colore blu
- n. 1 valvola a sfera ad angolo con maniglia a farfalla di colore rosso
- n. 2 bocchettoni con dado girevole
- n. 2 valvole di sfiato aria manuali
- n. 2 valvole di scarico acqua
- n. 2 termometri
- n. 2 tappi laterali ciechi.

***ARTICOLO IN ESAURIMENTO.**

CODICE	MISURA			
68559754	G 1"	1694	1	8
68559762*	G 1"1/4	2992	1	8

**KC 652**

Kit per collettori serie CD composto da:

- n. 1 valvola a sfera con maniglia a farfalla di colore blu
- n. 1 valvola a sfera con maniglia a farfalla di colore rosso
- n. 2 bocchettoni con dado girevole
- n. 2 valvole di sfiato aria manuali
- n. 2 valvole di scarico acqua
- n. 2 termometri
- n. 2 tappi laterali ciechi.

CODICE	MISURA			
68559758	G 1"	2112	1	8
68559766	G 1"1/4	2460	1	8

**KC 651**

Kit per collettori serie CD composto da:

- n. 1 valvola a sfera ad angolo con maniglia a farfalla di colore blu
- n. 1 valvola a sfera ad angolo con maniglia a farfalla di colore rosso
- n. 2 bocchettoni con dado girevole
- n. 2 valvole di sfiato aria automatica
- n. 2 valvole di scarico acqua
- n. 2 termometri
- n. 2 tappi laterali ciechi.

***ARTICOLO IN ESAURIMENTO.**

CODICE	MISURA			
68559756	G 1"	1996	1	8
68559764*	G 1"1/4	3294	1	8

**KC 653**

Kit per collettori serie CD composto da:

- n. 1 valvola a sfera con maniglia a farfalla di colore blu
- n. 1 valvola a sfera con maniglia a farfalla di colore rosso
- n. 2 bocchettoni con dado girevole
- n. 2 valvole di sfiato aria automatica
- n. 2 valvole di scarico acqua
- n. 2 termometri
- n. 2 tappi laterali ciechi.

CODICE	MISURA			
68559760	G 1"	2414	1	8
68559768	G 1"1/4	2762	1	8

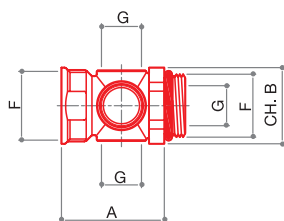
**CR 489**

Bocchettone a tenuta morbida con contro ghiera per valvola a sfera a 3 attacchi.

CODICE	MISURA	A	B	C	D	E	F	G	H	L			
68503425	G 1" x G 1/2	54	37	-	-	-	G 1"	G 1/2	-	-	187	16	128

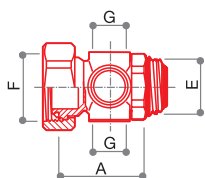
**CR 491**

Bocchettone a tenuta morbida per valvola a sfera a 3 attacchi con dado girevole.

CODICE	MISURA	A	B	C	D	E	F	G	H	L			
68559781	G 1" x G 1/2	53	-	-	-	G 1"	G 1 1/4	G 1/2	-	-	230	16	128
68559785	G 1 1/4 x G 1/2	66	-	-	-	G 1 1/4	G 1 1/2	G 1/2	-	-	382	8	64

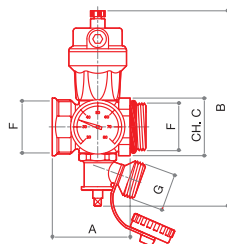
**CR 490**

Bocchettone a tenuta morbida con contro ghiera per valvola a sfera con termometro orientabile, valvola di sfiato automatica e rubinetto di svuotamento orientabile.

CODICE	MISURA	A	B	C	D	E	F	G	H	L			
68503430	G 1"	54	136	37	-	-	G 1"	G 3/4	-	-	530	4	32

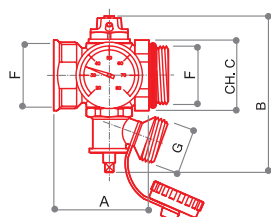
**CR 492**

Bocchettone a tenuta morbida con contro ghiera per valvola a sfera con termometro orientabile, valvola di sfiato manuale e rubinetto di svuotamento orientabile.

CODICE	MISURA	A	B	C	D	E	F	G	H	L			
68503434	G 1"	54	90	37	-	-	G 1"	G 3/4	-	-	379	4	32

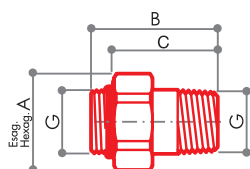
**RD 458**

Raccordo di unione M-M in tre pezzi con guarnizione o-ring.

CODICE	MISURA	A	B	C	D	E	F	G	H	L			
68992700N	G 3/4	37	52	42	-	-	-	G 3/4	-	-	168	20	160
68993400N	G 1"	47	54	45	-	-	-	G 1"	-	-	262	15	120

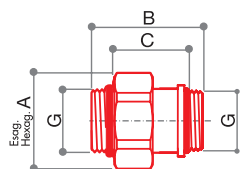
**RD 455**

Raccordo di unione M-M in tre pezzi con guarnizione o-ring.

CODICE	MISURA	A	B	C	D	E	F	G	H	L			
68992701N	G 3/4	37	48	29	-	-	-	G 3/4	-	-	120	20	160
68993401N	G 1"	46	48	28	-	-	-	G 1"	-	-	238	15	120

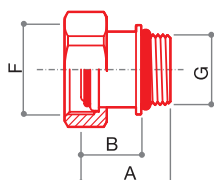
**CR 498**

Dado e raccordo nichelati, con tenuta o-ring per il collegamento delle valvole ai collettori di distribuzione.

CODICE	MISURA	A	B	C	D	E	F	G	H	L			
67901700	DN 10 3/8	26	18	-	-	-	G 5/8	G 3/8	-	-	60	50	400
67902100	DN 15 1/2	26	18	-	-	-	G 3/4	G 1/2	-	-	71	50	400
67902700	DN 20 3/4	33	23	-	-	-	G 1"	G 3/4	-	-	120	20	160
67903400	DN 25 1"	36	25	-	-	-	G 1 1/4	G 1"	-	-	220	15	120
67904200	DN 32 1 1/4	41	35	-	-	-	G 1 1/2	G 1 1/4	-	-	240	10	80

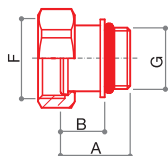
**CR 498/A**

Dado e raccordo nichelati, con tenuta piana.

CODICE	MISURA	A	B	C	D	E	F	G	H	L			
67922100	DN 15 1/2	23	15	-	-	-	G 3/4	G 1/2	-	-	68	50	400
67922700	DN 20 3/4	29,5	19,5	-	-	-	G 1"	G 3/4	-	-	104	20	160
67924200	DN 32 1 1/4	36	22,5	-	-	-	G 1 1/2	G 1 1/4	-	-	217	10	80

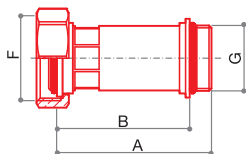
**CR 498/B**

Raccordo CR 498 maggiorato di 50 mm.

CODICE	MISURA	A	B	C	D	E	F	G	H	L			
67913400	DN 25 1"	77	66	-	-	-	G 1 1/4	G 1"	-	-	245	10	80

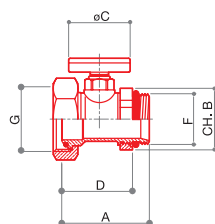
**CR 499**

Raccordo nichelato con dado girevole, contro ghiera e tenuta o-ring completo di termometro per il collegamento valvole a sfera ai collettori di distribuzione serie CD.

CODICE	MISURA	A	B	C	D	E	F	G	H	L			
68503428	G 1"	57	37	40	46	-	G 1"	G 1 1/4	-	-	270	8	64
68504228	G 1 1/4	78	48	40	66	-	G 1 1/4	G 1 1/2	-	-	496	4	32

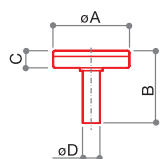

RT 488
Termometro.

CODICE	MISURA	A	B	C	D	E	F	G	H	L			
68559854	-	40	42	10	9	-	-	-	-	-	28	15	120

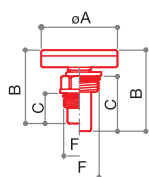

RT 487
Termometro con pozzetto.

CODICE	MISURA	A	B	C	D	E	F	G	H	L			
68559851	G 3/8	40	40	16	-	-	G 3/8	-	-	-	56	10	80
68559852	G 1/2	40	43	29	-	-	G 1/2	-	-	-	56	10	80

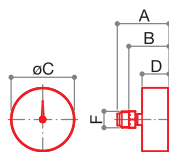

RTA 489
Termometro assiale con raccordo
provvisto di valvola di ritegno.

CODICE	MISURA	A	B	C	D	E	F	G	H	L			
68559855	G 1/2	65	51	80	34	-	G 1/2	-	-	-	155	1	50

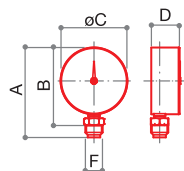

RTR 490
Termometro radiale con raccordo
provvisto di valvola di ritegno.

CODICE	MISURA	A	B	C	D	E	F	G	H	L			
68559856	G 1/2	108	94	80	34	-	G 1/2	-	-	-	152	1	50

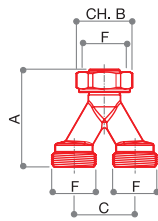

SD 484

Raccordo sdoppiatore nichelato.

CODICE	MISURA	A	B	C	D	E	F	G	H	L			
68502419	(W24x19)	58	27	36	-	-	W24x19	-	-	-	130	10	80
68502700	G 3/4 EK	58	30	36	-	-	G 3/4 EK	-	-	-	147	10	80

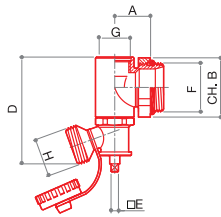

SA 483

Terminale per collettori, nichelato, con contro ghiera e rubinetto di scarico acqua incorporato in ottone:

- attacco per valvola di scarico aria.

CODICE	MISURA	A	B	C	D	E	F	G	H	L			
68503409	G 1" x G 3/8	24	37	-	72	5	G 1"	G 3/8	G 3/4	-	252	10	80
68503424	G 1" x G 1/2	24	37	-	72	5	G 1"	G 1/2	G 3/4	-	242	10	80

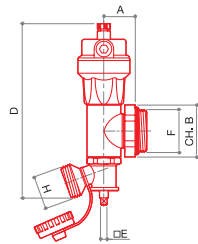

SA 483/A

Terminale per collettori, nichelato, con contro ghiera, rubinetto di scarico acqua in ottone e valvola di sfianto incorporata.

CODICE	MISURA	A	B	C	D	E	F	G	H	L			
68503423	G 1"	24	37	-	135	5	G 1"	-	G 3/4	-	417	8	64

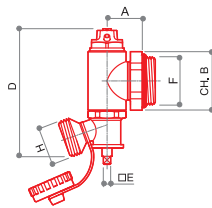

SA 483/B

Terminale per collettori, nichelato, con contro ghiera, rubinetto di scarico acqua in ottone e valvola di sfianto manuale incorporata.

CODICE	MISURA	A	B	C	D	E	F	G	H	L			
68503426	G 1"	24	37	-	90	5	G 1"	-	G 3/4	-	266	8	64

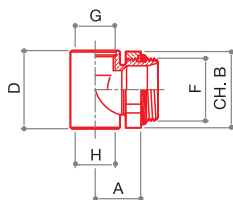

TC 488

Terminale per collettori con contro ghiera:

- attacco da G 3/8 F o G 1/2 F per valvola di scarico aria;
- attacco da G 1/2 F per valvola di scarico acqua.

CODICE	MISURA	A	B	C	D	E	F	G	H	L			
68503420	G 1/2 x G 1/2	24	37	-	41	-	G 1"	G 1/2	G 1/2	-	130	20	160
68503422	G 1/2 x G 3/8	24	37	-	41	-	G 1"	G 3/8	G 1/2	-	140	20	160

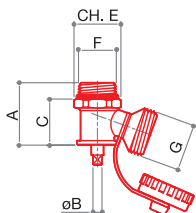
**SA 492**

Valvola di scarico acqua nichelata con tappo, laccetto e possibilità di rotazione dello scarico.

CODICE	MISURA	A	B	C	D	E	F	G	H	L			
68559815	G 1/2	34	5	25,5	-	24	G 1/2	G 3/4	-	-	112	30	240

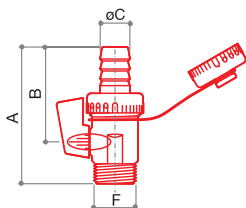

**SA 494**

Valvola a sfera nichelata per scarico acqua con leva, portagomma e tappo.

CODICE	MISURA	A	B	C	D	E	F	G	H	L			
68559799	G 1/2	68	47	15	-	-	G 1/2	-	-	-	107	15	120

**CB 1205**

Coibentatura per collettori serie CD e CX per 12 attacchi.

CODICE	MISURA			
72000064	CD G 1"	156	-	6
72000066	CX G 1"	149	-	6
72000065	CD G 1 1/4	180	-	6

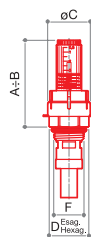

**TM 4012**

Regolatore e misuratore di portata 0,5÷5 l/min.

CODICE	MISURA	A	B	C	D	E	F	G	H	L			
69000010	G 1/2	57	61	30	24	-	G 1/2	-	-	-	60	25	200

**TM 4014**

Regolatore e misuratore di portata 0,5÷5 l/min.

CODICE	MISURA	A	B	C	D	E	F	G	H	L			
69000018	G 1/2	68,5	74	32,5	24	-	G 1/2	-	-	-	36	20	160

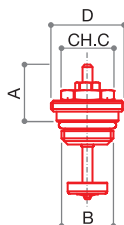
**560**

Vitone termostatico di comando per collettori serie CD.

CODICE	MISURA	QUOTA DI CHIUSURA	CORSA	A	B	C	D	E	F	G	H	L			
9446870	G 1/2	11,8	2,7	2,7	23	G 1/2	19	-	-	-	-		66	50	400

**555**

Vitone per collettori sanitari serie CP con valvole di intercettazione.

CODICE	MISURA	COLLETTORI SERIE CP			
9446820	G 3/8	da usare con collettori CP G 3/4	38	50	400
9446822	G 3/8	da usare con collettori CP G 1"	40	50	400

**516**

Completo assemblato di tenuta per astina di comando del vitone termostatico e termoelettrico.

CODICE	MISURA			
67980200	-	6	-	-

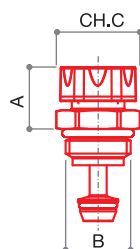
**563**

Vitone detentore predisposto per la doppia regolazione micrometrica di bilanciamento per collettori serie CD.

CODICE	FINITURA	MISURA	CORSA	A	B	C	D	E	F	G	H	L			
9446841	GIALLA	G 1/2	7,8	20	G 1/2	24	-	-	-	-	-	-	66	50	400
9446843	NICHELATA	G 1/2	7,8	20	G 1/2	24	-	-	-	-	-	-	66	50	400

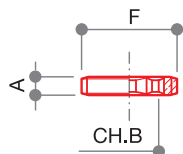
**501**

Ghiera di regolazione per detentori per collettori serie CD.

CODICE	MISURA	A	B	C	D	E	F	G	H	L			
3346656	-	5	8	-	-	-	G 1/4	-	-	-	1	-	-

**567**

Raccordo con sede per vitone termostatico di comando articolo 560, vitone detentore di regolazione articolo 563 e per regolatore e misuratore di portata articolo TM 4012, per collettori serie CD.

CODICE	MISURA	FINITURA	A	B	C	D	E	F						
68552678	CD G 1" G 1/2 x (W24x19)	GIALLA	26	10	9,3	24	G 1/2	W24x19	TR 91	TP 95	TP 97	43	50	400
68552679	CD G 1 1/4 G 1/2 x (W24x19)	GIALLA	36	10	19,3	24	G 1/2	W24x19	TR 91	TP 95	TP 97	49	50	400
68552675	CD G 1" G 1/2 x G 3/4 EK	GIALLA	26	10,5	9,3	27	G 1/2	G 3/4 EK	TR 91/A	TP 98	TP 99	54	50	400
68552677	CD G 1 1/4 G 1/2 x G 3/4 EK	GIALLA	36	10,5	19,3	27	G 1/2	G 3/4 EK	TR 91/A	TP 98	TP 99	60	50	400
68552678N	CD G 1" G 1/2 x (W24x19)	NICHELATA	26	10	9,3	24	G 1/2	W24x19	TR 91	TP 95	TP 97	43	50	400
68552679N	CD G 1 1/4 G 1/2 x (W24x19)	NICHELATA	36	10	19,3	24	G 1/2	W24x19	TR 91	TP 95	TP 97	49	50	400
68552675N	CD G 1" G 1/2 x G 3/4 EK	NICHELATA	26	10,5	9,3	27	G 1/2	G 3/4 EK	TR 91/A	TP 98	TP 99	53	50	400
68552677N	CD G 1 1/4 G 1/2 x G 3/4 EK	NICHELATA	36	10,5	19,3	27	G 1/2	G 3/4 EK	TR 91/A	TP 98	TP 99	60	50	400

**TM 4005**

Misuratore di portata 1÷4 l/min.

CODICE	MISURA	A	B	C	D	E	F	G	H	L						
69000012	(W24x19) x (W24x19)	72	-	-	-	-	W24x19	W24x19	-	-	TR 91	TP 95	TP 97	126	25	200
69000015	G 3/4 EK x G 3/4 EK	64	-	-	-	-	G 3/4 EK	G 3/4 EK	-	-	TR 91/A	TP 98	TP 99	138	25	200

DIAGRAMMA DI PORTATA MISURATORE DI PORTATA

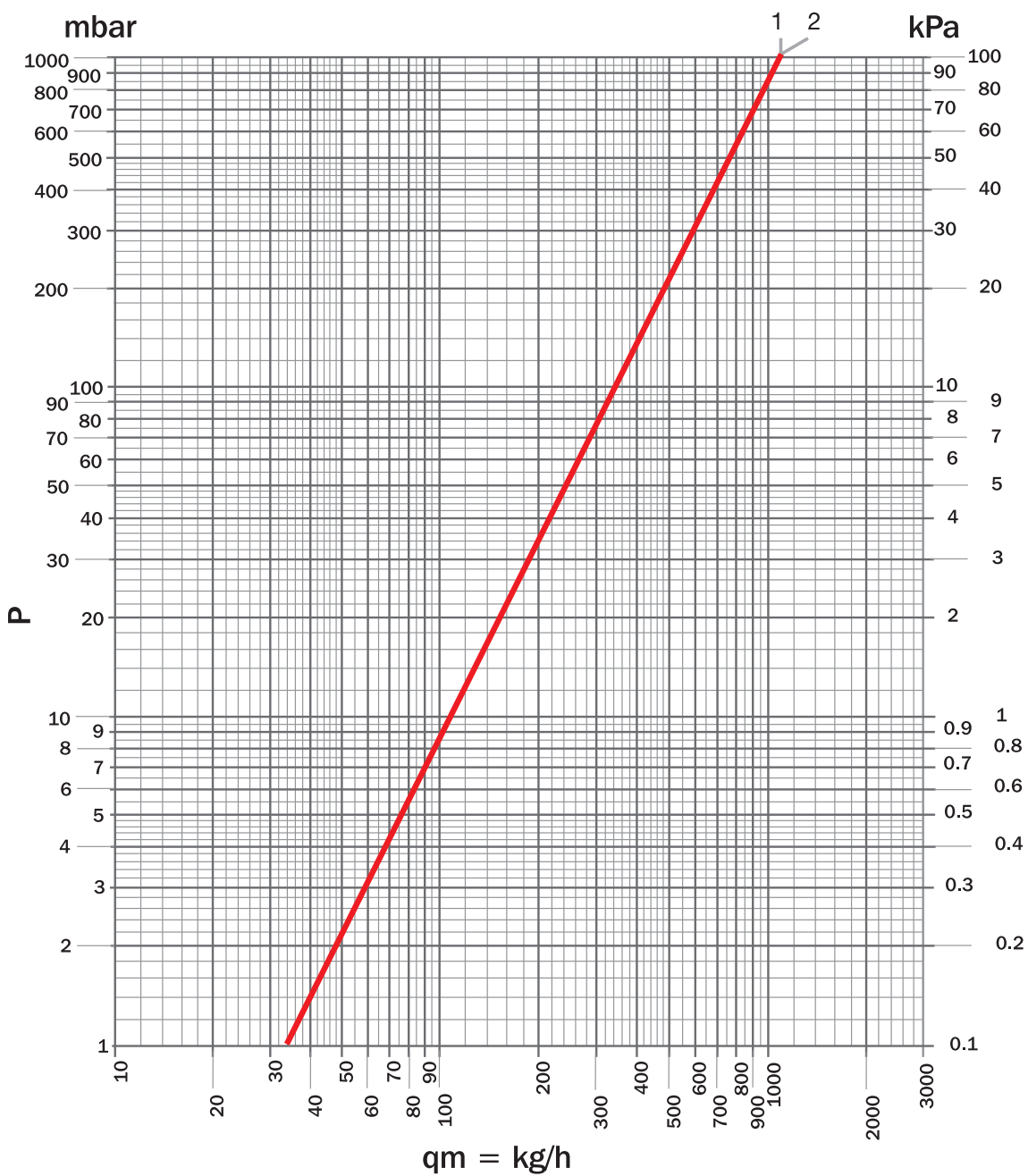

ARTICOLI	MISURA	Kvs	POS
TM 4005	W24x19	1,15	1
TM 4005	G 3/4 EK		2

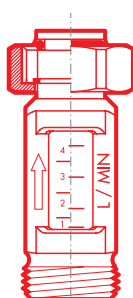

STAFFA REGOLABILE SC 497



La staffa ha un interasse regolabile da 200 - 210 - 220 - 230 - 240 - 250 - 260 mm in base alla necessità.

La staffa universale è adatta per tutti i collettori Luxor ad esclusione della serie CD da G1"1/4.

CARATTERISTICHE TECNICHE



Materiale vite

Fe



Materiale staffa

DD11



Materiale cavallotto

PA6

ISTRUZIONI UTILIZZO STAFFE REGOLABILI SC 497

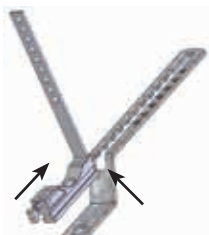

1. Inserire i cavallotti sulla staffa facendoli scorrere nel profilo ad "H".



5. Il cavallotto è composto da una fascetta flessibile che può avvolgere qualsiasi forma del prodotto da fissare con questa staffa.



2. Allineare il foro centrale con l'interasse voluto (esempio nell'immagine 200mm), regolazione da 200mm a 260mm.



6. La fascetta può essere bloccata in 2 modi. Il primo prevede di inserire il perno fisso del cavallotto in uno dei fori della fascetta. In questo modo si ottiene un posizionamento del prodotto senza l'utilizzo di utensili. In alcune installazioni potrebbe essere sufficiente perché non è necessario ancorare saldamente il collettore.



3. Staccare il perno di blocco dal cavallotto e inserirlo ad incastro nell'apposita sede.





7. La fascetta può essere bloccata in 2 modi. Il secondo prevede l'utilizzo di una vite autofilettante che posizionata nell'opportuno foro della fascetta può serrare e bloccare saldamente il collettore alla staffa.

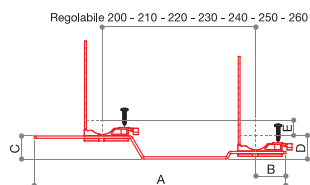

4. Ripetere l'operazione con l'altro cavallotto per la posizione fissa non regolabile.



**SC 497**

Staffa in metallo/poliammide regolabile universale per il fissaggio dei collettori alle cassette in metallo oppure a parete.

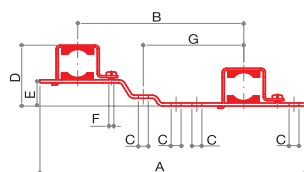
CODICE	MISURA	A	B	C	D	E	F	G	H	L			
68559538	-	327.5	39	30	30.5	20	-	-	-	-	140	-	100





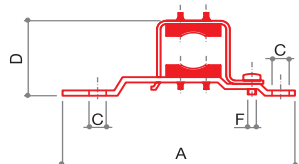

**SC 496**

Supporto metallico per collettori serie CD e CX.

CODICE	MISURA	A	B	C	D	E	F	G	H	L			
68559528	CD G 3/4 x 200	319	200	12	79	34	6 MA	119	-	-	270	-	100
68559535	CD G 1" x 200	319	200	12	79	30	6 MA	119	-	-	260	-	100
68559537	CX G 1" x 200	319	200	12	79	30	6 MA	119	-	-	265	-	100
68559734	CD G 1" x 250	366	250	12	89	-	6 MA	-	-	-	294	-	50
68559543	CD G 1"1/4 x 200	319	200	12	90	30	6 MA	114	-	-	290	-	80





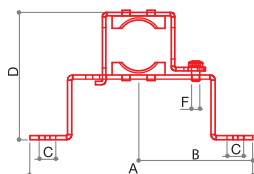

**SC 496/A**

Supporto metallico semplice per collettori.

CODICE				A	B	C	D	E	F			
68559429	3/4	1"	3/4	162,5	-	12	56,5	-	6 MA	140	-	100
68559436	1"	-	-	162,5	-	12	56,5	-	6 MA	134	-	100
68559437	-	-	1"	162,5	-	12	56,5	-	6 MA	138	-	100
68559442	1"1/4	-	-	162,5	-	12	56,5	-	6 MA	148	-	100

**SC 496/B**

Supporto metallico alto semplice per collettori.

CODICE				A	B	C	D	E	F			
68559428	3/4	1"	3/4	160	82	12	92	-	6 MA	136	-	70
68559435	1"	-	-	160	82	12	92	-	6 MA	136	-	70
68559433	-	-	1"	160	82	12	92	-	6 MA	140	-	70
68559443	1"1/4	-	-	160	87	12	103	-	6 MA	149	-	70

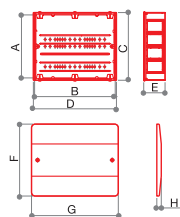
**CF 477**

Cassetta componibile universale in plastica con fondo completa di rete da intonaco supporti per bloccaggio collettori semplici componibili, collettori complanari e collettori di distribuzione.

CODICE	MISURA	A	B	C	D	E	F	G	H	L			
68560432	272 x 332 x 86	260	320	272	332	86	290	350	18	-	1000	1	20
68560440	272 x 412 x 86	260	400	272	412	86	290	430	18	-	1250	1	20
68560450	272 x 512 x 86	260	500	272	512	86	290	530	18	-	1500	1	20
68560460	272 x 612 x 86	260	600	272	612	86	290	630	18	-	1750	1	20

**AC 477**

Kit accessori di **ricambio** per il fissaggio dei collettori nella cassetta CF 477.

CODICE	MISURA			
68560001	-	60	1	-

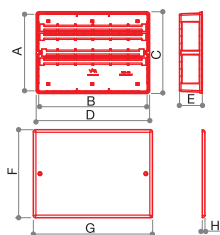
**CF 479**

Cassetta universale in plastica con fondo completa di supporti per bloccaggio collettori semplici componibili, collettori complanari e collettori di distribuzione.

CODICE	MISURA	A	B	C	D	E	F	G	H	L			
68560332	290 x 330 x 88	280	320	290	330	88	320	360	10	-	930	1	5
68560342	310 x 430 x 88	300	420	310	430	88	340	460	10	-	1175	1	5
68560352	330 x 530 x 88	320	520	330	530	88	360	560	10	-	1425	1	5
68560362	330 x 625 x 88	320	615	330	625	88	360	660	10	-	1715	1	5

**AC 479**

Kit accessori di **ricambio** per il fissaggio dei collettori nella cassetta CF 479.

CODICE	MISURA			
68560005	-	70	1	-

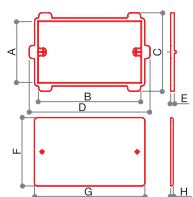
**CT 474**



Coperchio con telaio in plastica.

CODICE	MISURA	A	B	C	D	E	F	G	H	L			
68560040	240 x 400	230	390	305	465	14	265	425	10	-	501	-	50
68560050	240 x 500	230	490	305	565	14	265	525	10	-	622	-	35
68560060	240 x 600	230	590	305	665	14	265	625	10	-	752	-	35

**CT 488**

Cornice e porta in acciaio verniciato di bianco RAL 9016. Ricambio per CF 485, CF 486, CF 487 e CF 492.



ARTICOLO IN ESAURIMENTO.

CODICE	MISURA			
68561005	500 x 450	3	-	1
68561007	700 x 450	4	-	1
68561008	850 x 450	5	-	1
68561010	1000 x 450	6	-	1
68561012	1200 x 450	7	-	1

**CT 489**



Cornice e porta in acciaio verniciato di bianco RAL 9016. Ricambio per CF 489, CF 490 e CF 491.

ARTICOLO IN ESAURIMENTO.

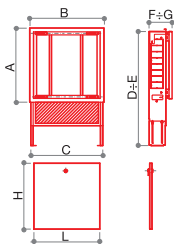
CODICE	MISURA			
68561105	500 x 560	4	-	1
68561107	700 x 560	5	-	1
68561108	850 x 560	6	-	1
68561110	1000 x 560	7	-	1
68561112	1200 x 560	8	-	1
68561113	1300 x 560	9	-	1



**CF 485**

Cassetta a muro per riscaldamento e sanitario in acciaio zincato, con telaio e supporto regolabili, porta e cornice verniciate di colore bianco RAL 9016 per collettori serie CD.

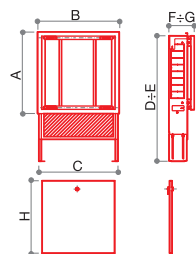
CODICE	MISURA	A	B	C	D	E	F	G	H	L			
68560705	500 x 620 x 110	530	562	500	620	750	110	150	450	490	8	-	1
68560707	700 x 620 x 110	530	762	700	620	750	110	150	450	690	11	-	1
68560708	850 x 620 x 110	530	912	850	620	750	110	150	450	840	14	-	1
68560710	1000 x 620 x 110	530	1062	1000	620	750	110	150	450	990	17	-	1
68560712	1200 x 620 x 110	530	1262	1200	620	750	110	150	450	1190	20	-	1



**CF 490**

Cassetta a muro per riscaldamento e sanitario in acciaio zincato, con telaio e supporto regolabili, porta e cornice verniciate di colore bianco RAL 9016 per collettori serie CD.

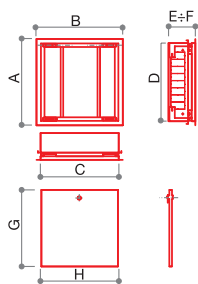
CODICE	MISURA	A	B	C	D	E	F	G	H	L			
68561405	500 x 720 x 90	630	560	500	720	860	90	130	560	490	9	-	1
68561407	700 x 720 x 90	630	760	700	720	860	90	130	560	690	12	-	1
68561408	850 x 720 x 90	630	910	850	720	860	90	130	560	840	15	-	1
68561410	1000 x 720 x 90	630	1060	1000	720	860	90	130	560	990	18	-	1
68561412	1200 x 720 x 90	630	1260	1200	720	860	90	130	560	1190	21	-	1
68561413	1300 x 720 x 90	630	1360	1300	720	860	90	130	560	1290	22,5	-	1



**CF 491**

Cassetta a muro per riscaldamento e sanitario in acciaio zincato, con telaio regolabile, porta e cornice verniciate di colore bianco RAL 9016 per collettori serie CD.

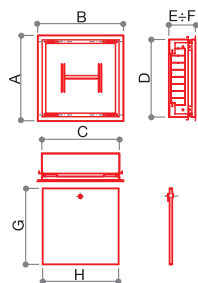
CODICE	MISURA	A	B	C	D	E	F	G	H	L			
68561505	500 x 600 x 90	630	560	500	600	90	130	560	490	-	8	-	1
68561507	700 x 600 x 90	630	760	700	600	90	130	560	690	-	11	-	1
68561508	850 x 600 x 90	630	910	850	600	90	130	560	840	-	13	-	1
68561510	1000 x 600 x 90	630	1060	1000	600	90	130	560	990	-	15	-	1
68561512	1200 x 600 x 90	630	1260	1200	600	90	130	560	1190	-	18	-	1

**CF 492**

Cassetta a muro per riscaldamento e sanitario in acciaio zincato, con telaio regolabile, porta e cornice verniciate di colore bianco RAL 9016 per collettori serie CD.

CODICE	MISURA	A	B	C	D	E	F	G	H	L			
68561605	500 x 500 x 80	530	562	500	500	80	120	450	490	-	7	-	1
68561607	700 x 500 x 80	530	762	700	500	80	120	450	690	-	9	-	1
68561608	850 x 500 x 80	530	912	850	500	80	120	450	840	-	10,5	-	1

**AC 490**

Kit accessori: guide e bulloni di ricambio per cassette CF 485 e CF 492.

CODICE	MISURA			
68560002	-	434	1	-

**AC 489**

Kit accessori: guide e bulloni di ricambio per cassette CF 490 e CF 491.

CODICE	MISURA			
68560003	-	506	1	-

G 1"

SCHEMA PER SELEZIONARE LA CASSETTA CORRETTA

COLLETTORI DA G 1"

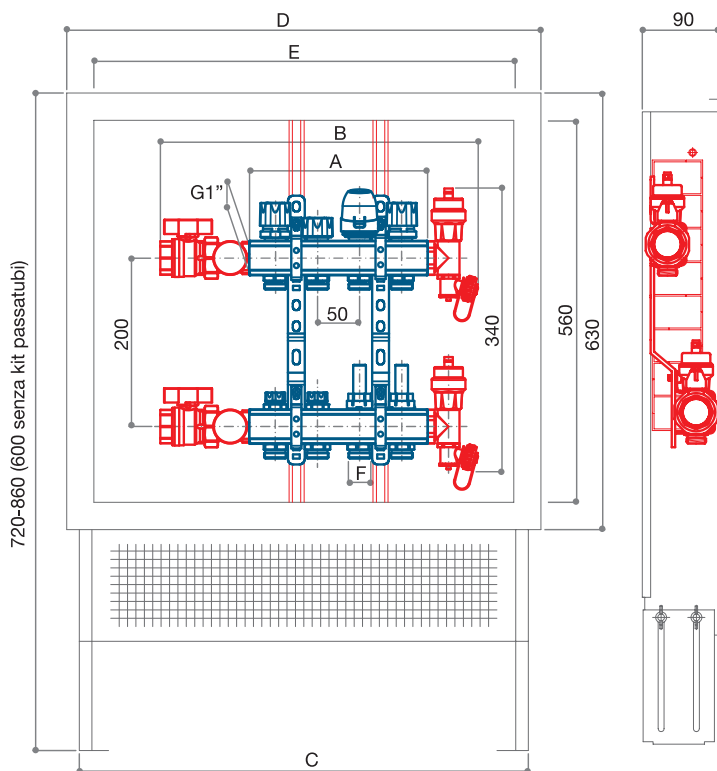

							CASSETTE	
VIE	A	B	C	D	E	F	ART.	COD.
2	112	276	500	560	490	W24x19 - G 3/4 EK	CF 490	68561405
3	162	326						
4	212	376						
5	262	426	700	760	690		CF 490	68561407
6	312	476						
7	362	526						
8	412	576	850	910	840		CF 490	68561408
9	462	626						
10	512	676						
11	562	726	1000	1060	990		CF 490	68561410
12	612	776						
13	662	826						

COLLETTORI DA G 1" CON SPURGO

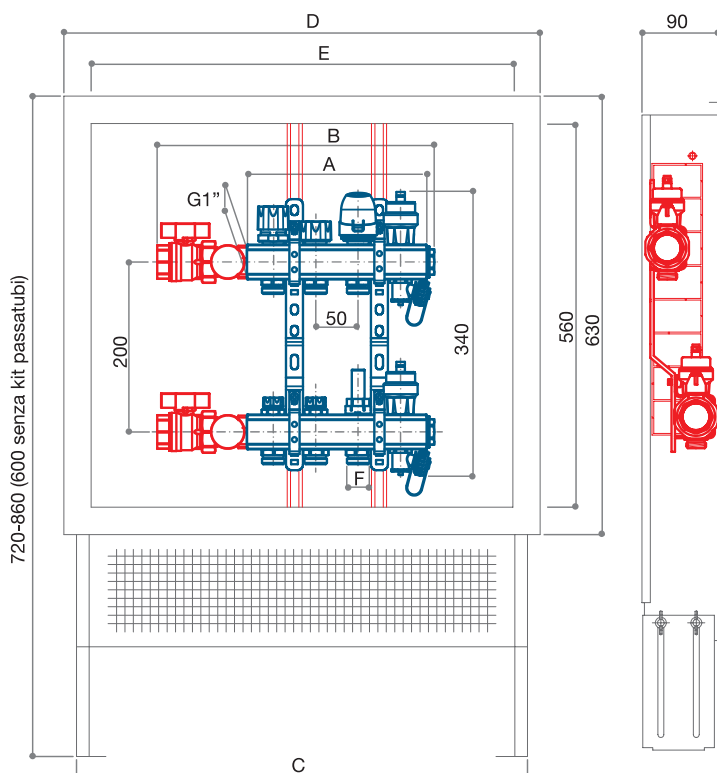

							CASSETTE	
VIE	A	B	C	D	E	F	ART.	COD.
2	162	276	500	560	490	W24x19 - G 3/4 EK	CF 490	68561405
3	212	326						
4	262	376						
5	312	426	700	760	690		CF 490	68561407
6	362	476						
7	412	526						
8	462	576	850	910	840		CF 490	68561408
9	512	626						
10	562	676						
11	612	726	1000	1060	990		CF 490	68561410
12	662	776						
13	712	826						

G 1 1/4

SCHEMA PER SELEZIONARE LA CASSETTA CORRETTA

COLLETTORI DA G 1 1/4

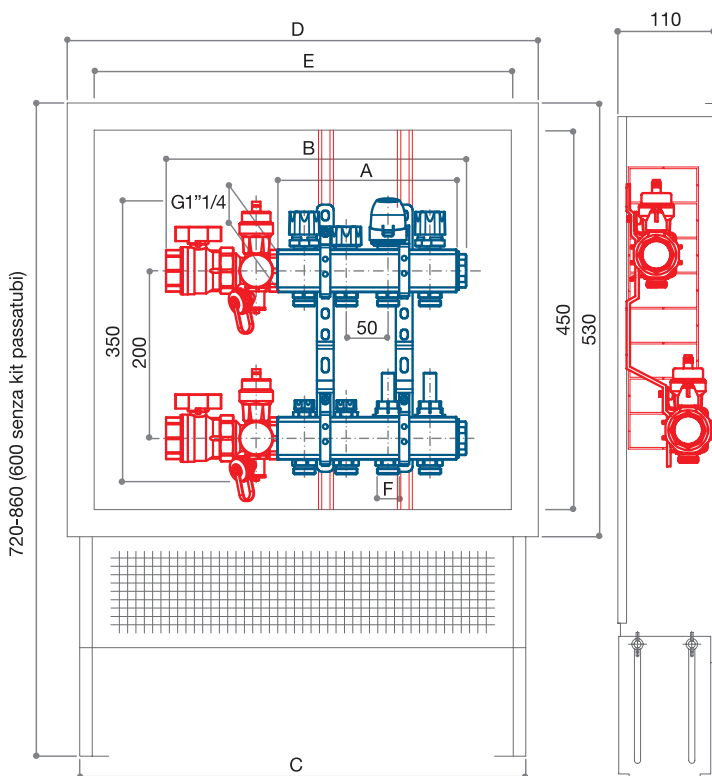

							CASSETTE	
VIE	A	B	C	D	E	F	ART.	COD.
2	114	260	500	565	490	W24x19 - G 3/4 EK	CF 485	68560705
3	164	310						
4	214	360						
5	264	410						
6	314	460	700	765	690		CF 485	68560707
7	364	510						
8	414	560						
9	464	610						
10	514	660	850	915	840		CF 485	68560708
11	564	710						
12	614	760						
13	664	810						

COLLETTORI DA G 1 1/4 CON SPURGO

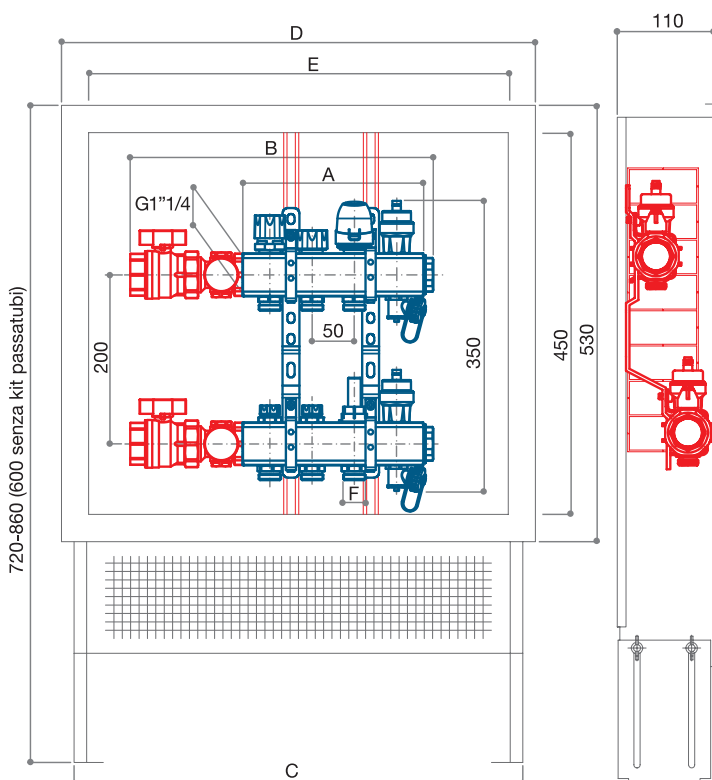

							CASSETTE						
VIE	A	B	C	D	E	F	ART.	COD.					
2	164	310	500	565	490	W24x19 - G 3/4 EK	CF 485	68560705					
3	214	360											
4	264	410											
5	314	460											
6	364	510	700	765	690		CF 485	68560707					
7	414	560											
8	464	610											
9	514	660											
10	564	710	850	915	840		CF 485	68560708					
11	614	760											
12	664	810							1000	1065	990	CF 485	68560710

G 1"

SCHEMA PER SELEZIONARE LA CASSETTA CORRETTA

COLLETTORI DA G 1"

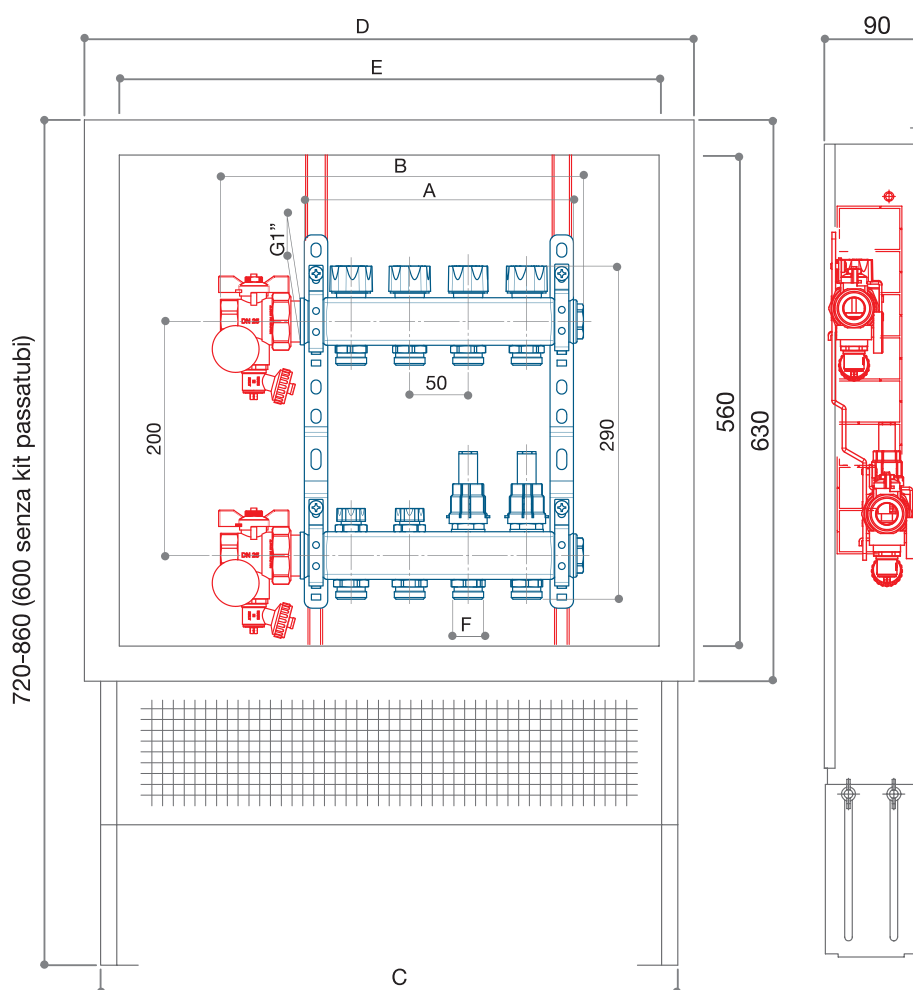

VIE	A	B	C	D	E	F	CASSETTE	
							ART.	COD.
2	130	210	500	560	490	W24x19 - G 3/4 EK	CF 490	68561405
3	180	260						
4	230	310						
5	280	360						
6	330	410	700	760	690		CF 490	68561407
7	380	460						
8	430	510						
9	480	560						
10	530	610	850	910	840		CF 490	68561408
11	580	660						
12	630	710						
13	680	760						
14	730	810	1000	1060	990		CF 490	68561410
15	780	860						
16	830	910						



LUXOR®

3 / VALVOLE

VALVOLE A SFERA



CARATTERISTICHE TECNICHE



Max temperatura

90 °C



Max pressione

10 bar



Materiale

CW617N

CARATTERISTICHE COSTRUTTIVE

Tutte le valvole a sfera Luxor vengono prodotte in ottone CW617N e sono compatibili con i collettori e con gli altri componenti prodotti da Luxor.

Data la varietà delle misure e delle tipologie, riescono a soddisfare le più svariate esigenze di utilizzo.

Tutte le valvole a sfera hanno il perno di manovra montato dall'interno. Questo sistema è chiamato "antiscoppio" perché offre maggiori garanzie contro la fuoriuscita accidentale del perno e del relativo sistema di tenuta, e per l'impossibilità di essere manomesso dall'esterno.

Le valvole a sfera presentano una doppia tenuta con anelli O-Ring in elastomero, scelto per l'elevata resistenza all'invecchiamento.

In conformità al D.M. 174/2004 per il trasporto di acque potabili, la lavorazione delle valvole viene eseguita dopo la fase di nichelatura, garantendo l'igienicità del particolare e un'aprezzabile qualità estetica.

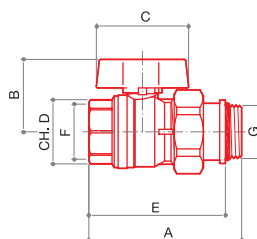

VC 471

Valvola a sfera a passaggio totale, nichelata, con maniglia a farfalla di colore blu o rosso e raccordo articolo CR 498 con o-ring per attacco al collettore.

CODICE	MISURA	A	B	C	D	E	F	G	H	L			
68559772B	G 1/2	69	40	48	25	61	G 1/2	G 1/2	-	-	210	10	80
68559772R	G 1/2	69	40	48	25	61	G 1/2	G 1/2	-	-	210	10	80
68559805B	G 3/4	90	39	60	33	80	G 3/4	G 3/4	-	-	370	10	80
68559805R	G 3/4	90	39	60	33	80	G 3/4	G 3/4	-	-	370	10	80
68559807B	G 1"	89	43	60	41	78	G 1"	G 1"	-	-	467	5	40
68559807R	G 1"	89	43	60	41	78	G 1"	G 1"	-	-	467	5	40
68559825B	G 1 1/4	123	53	72	50	109	G 1 1/4	G 1 1/4	-	-	907	3	24
68559825R	G 1 1/4	123	53	72	50	109	G 1 1/4	G 1 1/4	-	-	907	3	24

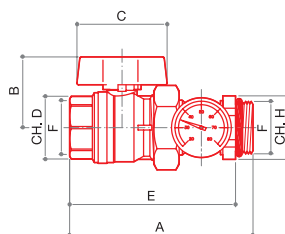



VC 471/A

Valvola a sfera con maniglia a farfalla di colore blu o rosso completa di termometro scala 0 °C÷80 °C per collettori serie CD.

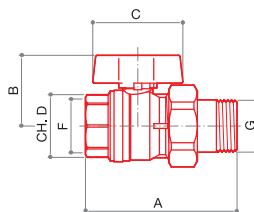
CODICE	MISURA	A	B	C	D	E	F	G	H	L			
68559800B	G 1"	115	43	60	41	104	G 1"	-	37	-	562	4	32
68559800R	G 1"	115	43	60	41	104	G 1"	-	37	-	562	4	32



**VC 472**

Valvola a sfera a passaggio totale, nichelata, con maniglia a farfalla di colore blu o rosso e raccordo.

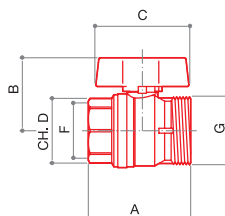
CODICE	MISURA	A	B	C	D	E	F	G	H	L			
68559774B	G 1/2	73	40	48	25	-	G 1/2	G 1/2	-	-	205	10	80
68559774R	G 1/2	73	40	48	25	-	G 1/2	G 1/2	-	-	205	10	80
68559806B	G 3/4	91	39	60	33	-	G 3/4	G 3/4	-	-	365	10	80
68559806R	G 3/4	91	39	60	33	-	G 3/4	G 3/4	-	-	365	10	80
68559808B	G 1"	95	43	60	41	-	G 1"	G 1"	-	-	487	5	40
68559808R	G 1"	95	43	60	41	-	G 1"	G 1"	-	-	487	5	40
68559818B	G 1 1/4	126	53	72	50	-	G 1 1/4	G 1 1/4	-	-	904	3	24
68559818R	G 1 1/4	126	53	72	50	-	G 1 1/4	G 1 1/4	-	-	904	3	24



**VC 475**

Valvola a sfera a passaggio totale, nichelata, senza bocchettone, con maniglia a farfalla di colore blu o rosso.

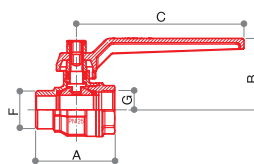
CODICE	MISURA	A	B	C	D	E	F	G	H	L			
68559770B	G 1/2F x G 3/4M	45	40	48	25	-	G 1/2	G 1/2	-	-	138	10	80
68559770R	G 1/2F x G 3/4M	45	40	48	25	-	G 1/2	G 1/2	-	-	138	10	80
68559811B	G 3/4F x G 1"M	59	39	60	33	-	G 3/4	G 1"	-	-	252	10	80
68559811R	G 3/4F x G 1"M	59	39	60	33	-	G 3/4	G 1"	-	-	252	10	80
68559809B	G 1"F x G 1 1/4M	61	43	60	41	-	G 1"	G 1 1/4	-	-	311	5	40
68559809R	G 1"F x G 1 1/4M	61	43	60	41	-	G 1"	G 1 1/4	-	-	311	5	40
68559804B	G 1 1/4F x G 1 1/2M	87	53	72	50	-	G 1 1/4	G 1 1/2	-	-	666	3	24
68559804R	G 1 1/4F x G 1 1/2M	87	53	72	50	-	G 1 1/4	G 1 1/2	-	-	666	3	24

**VC 476**

Valvola a sfera a passaggio totale, nichelata, senza bocchettone, con leva di colore blu o rossa.

CODICE	MISURA	A	B	C	D	E	F	G	H	L			
68559829B	G 1 1/2	91	75	150	-	-	G 1 1/2	G 1 1/2	-	-	1400	2	16
68559829R	G 1 1/2	91	75	150	-	-	G 1 1/2	G 1 1/2	-	-	1400	2	16

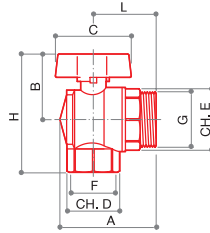

VS 470

Valvola a sfera a passaggio totale, nichelata, senza bocchettone, con maniglia a farfalla di colore blu o rosso.
*ARTICOLO IN ESAURIMENTO.

CODICE	MISURA	A	B	C	D	E	F	G	H	L			
68559810B	G 1" F x G 1" 1/4 M	72	50	57	39	43	G 1"	G 1" 1/4	90	47	582	5	40
68559810R	G 1" F x G 1" 1/4 M	72	50	57	39	43	G 1"	G 1" 1/4	90	47	582	5	40
68559776B*	G 1" 1/4 F x G 1" 1/2 M	-	-	-	-	-	G 1" 1/4	G 1" 1/2	-	-	810	3	24
68559776R*	G 1" 1/4 F x G 1" 1/2 M	-	-	-	-	-	G 1" 1/4	G 1" 1/2	-	-	810	3	24

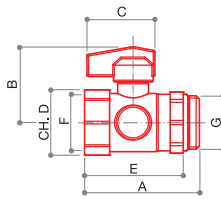

VCG 480

Valvola a sfera nichelata con maschio girevole e maniglia di colore blu o rosso.

CODICE	MISURA	A	B	C	D	E	F	G	H	L			
68559719B	G 1"	71	42	42	38	61	G 1"	G 1"	-	-	368	5	40
68559719R	G 1"	71	42	42	38	61	G 1"	G 1"	-	-	368	5	40

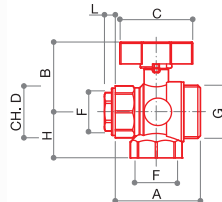

VCS 476

Valvola a sfera nichelata diritta e squadra senza bocchettone con maniglia di colore blu o rosso.

CODICE	MISURA	A	B	C	D	E	F	G	H	L			
68559711B	G 1" F x G 1" 1/4 M	66,5	55	62	38	-	G 1"	G 1" 1/4	36	9	510	5	40
68559711R	G 1" F x G 1" 1/4 M	66,5	55	62	38	-	G 1"	G 1" 1/4	36	9	510	5	40

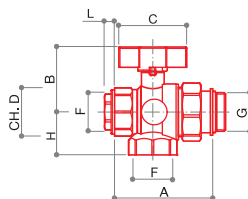



VCS 478

Valvola a sfera nichelata diritta e squadra con maniglia di colore blu o rosso e raccordo art. CR 498 con o-ring per attacco al collettore.

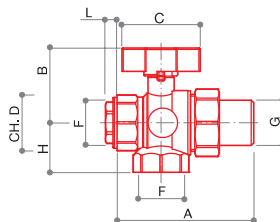
CODICE	MISURA	A	B	C	D	E	F	G	H	L			
68559715B	G 1"	82	55	62	38	-	G 1"	G 1"	36	9	658	5	40
68559715R	G 1"	82	55	62	38	-	G 1"	G 1"	36	9	658	5	40



**VCS 477**

Valvola a sfera nichelata diritta e squadra con maniglia di colore blu o rosso e raccordo.

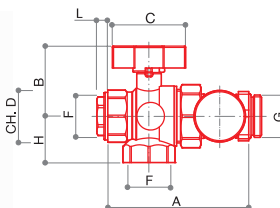
CODICE	MISURA	A	B	C	D	E	F	G	H	L			
68559713B	G 1"	99	55	62	38	-	G 1"	G 1"	36	9	684	5	40
68559713R	G 1"	99	55	62	38	-	G 1"	G 1"	36	9	684	5	40

**VCS 479**

Valvola a sfera nichelata diritta e squadra con maniglia di colore blu o rosso completa di termometro scala 0 °C ÷ 80 °C per collettori di serie CD.

CODICE	MISURA	A	B	C	D	E	F	G	H	L			
68559717B	G 1"	110	55	62	38	-	G 1"	G 1"	36	9	766	4	32
68559717R	G 1"	110	55	62	38	-	G 1"	G 1"	36	9	766	4	32

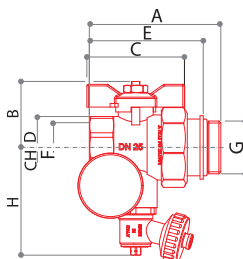
**VC 481**

Valvola a sfera multifunzione con scarico aria manuale, carico acqua, maniglia a farfalla di colore di colore blu o rosso e raccordo art. CR 498 con o-ring per attacco al collettore completa di termometro scala 0 °C ÷ 80 °C.

CODICE	MISURA	A	B	C	D	E	F	G	H	L			
68559722B	G 1"	81	41	60	38	70	G 1"	G 1"	70	-	645	4	32
68559722R	G 1"	81	41	60	38	70	G 1"	G 1"	70	-	645	4	32

VALVOLE BYPASS PER IMPIANTI RISCALDAMENTO



CARATTERISTICHE TECNICHE



Materiale parti
in ottone
CW614N



Guarnizioni OR
EPDM



Molla
AISI 302

FUNZIONALITÀ

L'utilizzo della valvola di bypass è necessario in tutti gli impianti di distribuzione dove sono presenti valvole di zona a 2 vie o corpi scaldanti muniti di valvole di regolazione che consentono in determinate condizioni, la completa esclusione del circuito. La valvola garantisce un ricircolo tale da impedire che la pompa sia utilizzata in condizioni lontane da quelle di progetto evitando sbilanciamenti dei circuiti funzionanti in parallelo e fastidiosi rumori dovuti all'aumento della velocità del fluido nell'attraversamento degli organi di regolazione stessi. La valvola di bypass VB 755 è stata studiata in particolare per essere facilmente impiegata sui collettori di distribuzione di nostra produzione e su una gamma di accessori per gli stessi. La valvola di bypass può essere montata su articoli assai diversi tra loro per i quali è richiesta solamente la presenza di due filetti da G 1/2 femmina contrapposti.

MONTAGGIO

Inserire la valvola di bypass tra la tubazione di andata e ritorno a valle della pompa di circolazione.

Come mostra il disegno la valvola è composta da 2 parti:

- sede valvola con raccordo per l'ingresso del fluido;
- elemento di regolazione con scala da 0,2 a 0,7 bar.

Attenzione: il raccordo deve essere montato solo dal lato di ingresso del fluido.

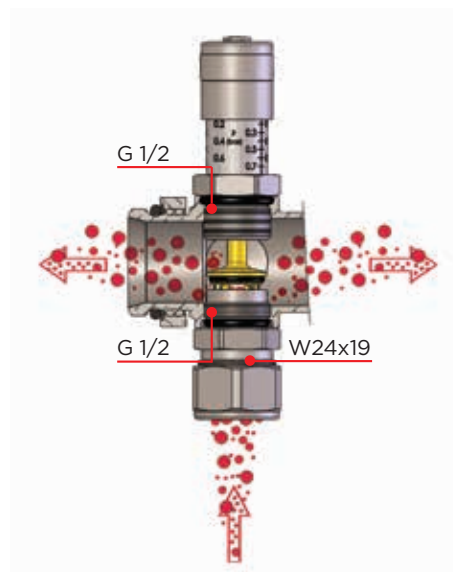
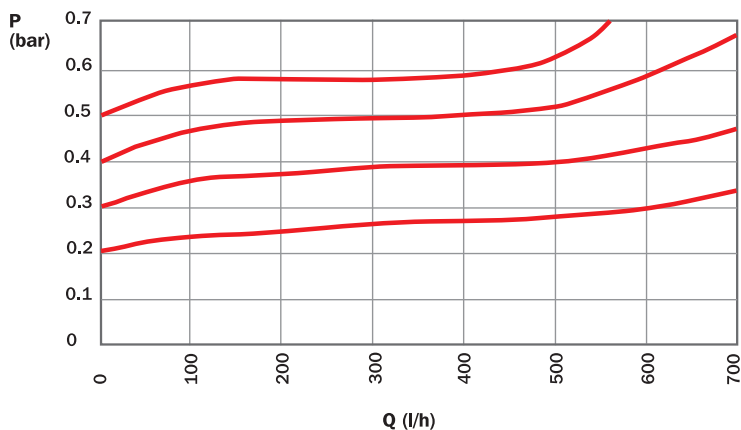

REGOLAZIONE

Ruotare la manopola fino a far coincidere il bordo della stessa con il valore desiderato riportato sulla scala graduata presente sul corpo della valvola.

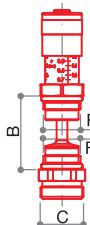



**VB 755**

Valvola di bypass.

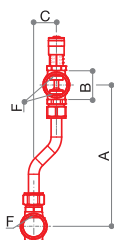
CODICE	MISURA	A	B	C	D	E	F	G	H	L			
68512109	CD G 1"	-	41	W24x19	-	-	G 1/2	-	-	-	158	10	80
68512110	CD G 1 1/4	-	51	W24x19	-	-	G 1/2	-	-	-	182	10	80



**VB 750**

Valvola di bypass.

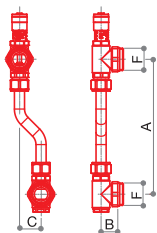
CODICE	MISURA	A	B	C	D	E	F	G	H	L			
68512101	CD G 1" x 200 mm	200	41	32	-	-	G 1/2	-	-	-	330	8	64
68512115	CD G 1" x 250 mm	250	41	32	-	-	G 1/2	-	-	-	350	8	64
68512102	CD G 1 1/4 x 200 mm	200	51	32	-	-	G 1/2	-	-	-	330	8	64



**VB 751**

Valvola di bypass con terminali per collettore.

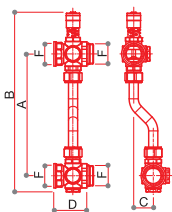
CODICE	MISURA	A	B	C	D	E	F	G	H	L			
68512103	G 1" x 200 mm	200	25	32	-	-	G 1"	-	-	-	400	5	40
68512116	G 1" x 250 mm	250	25	32	-	-	G 1"	-	-	-	420	4	32



**VB 752**

Valvola di bypass con bocchettoni per valvola a sfera con o senza termometro.

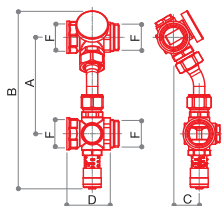
CODICE	MISURA	A	B	C	D	E	F	G	H	L			
68512105	G 1" x 200 mm	200	295	32	54	-	G 1"	-	-	-	766	3	24
68512117	G 1" x 250 mm	250	295	32	54	-	G 1"	-	-	-	820	3	24

**VB 753**

Valvola di bypass kit alta per GM 1192.

CODICE	MISURA	A	B	C	D	E	F	G	H	L			
68512108	G 1"	120	223	32	54	-	G 1"	-	-	-	784	3	24

VALVOLE DI SCARICO ARIA



CARATTERISTICHE TECNICHE

- Max temperatura
 110 °C
- Max temperatura
 (valvole per sistema
 solare)
 200 °C
- Max pressione
 10 bar
- Max pressione
 di scarico
 6 bar

INSTALLAZIONE ED UTILIZZO

Le valvole di scarico aria serie VS hanno ottime caratteristiche di portata d'aria e sono indispensabili per liberare gli impianti idrotermici dall'eventuale presenza di bolle d'aria. Pur avendo una notevole capacità di portata d'aria, il loro ingombro è tale da consentirne l'utilizzo su caldaie murali a gas, su collettori ed ovunque si manifesti la necessità di liberare le condutture dalla presenza d'aria.

La valvola permette la completa evacuazione dell'aria in modo automatico oppure in modo manuale nelle relative tipologie.

La valvola deve essere installata in posizione verticale nei punti dell'impianto dove è favorito l'accumulo di bolle d'aria. Il funzionamento automatico avviene con il tappo in ottone allentato.

Se le valvole sfiato aria automatiche sono montate con la valvolina di ritegno VS 605 allora si potrà rimuoverle senza dover scaricare l'impianto.

Le valvole di sfiato aria automatiche esistono anche nella versione per impianti solari con una temperatura massima di utilizzo di 200 °C.

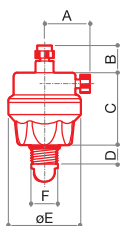

VS 602

Valvola automatica e manuale di sfogo aria tipo ridotto da G 3/8. Finitura nichelata.

CODICE	MISURA	A	B	C	D	E	F	G	H	L			
67790310N	G 3/8	25	15	40	10	40	G 3/8	-	-	-	148	15	120

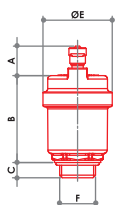

VS 604/A

Valvola automatica di sfogo aria.



CODICE	MISURA	FINITURA	A	B	C	D	E	F	G	H	L			
67790300	G 3/8	GIALLA	17	50	9	-	40	G 3/8	-	-	-	138	10	100
67790700	G 1/2	GIALLA	17	50	9	-	40	G 1/2	-	-	-	138	10	100
67790300N	G 3/8	NICHELATA	17	50	9	-	40	G 3/8	-	-	-	138	10	100
67790700N	G 1/2	NICHELATA	17	50	9	-	40	G 1/2	-	-	-	138	10	100

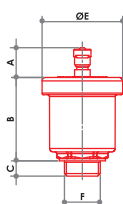

VS 601

Valvola di sfogo aria automatica tipo medio.



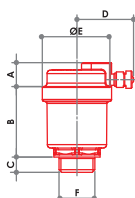

CODICE	MISURA	A	B	C	D	E	F	G	H	L			
67790117	G 3/8	17	50	9	-	46	G 3/8	-	-	-	154	10	100
67790121	G 1/2	17	50	9	-	46	G 1/2	-	-	-	154	10	100
67790127	G 3/4	17	50	9	-	46	G 3/4	-	-	-	154	10	100

**VS 603**

Valvola sfogo aria automatica
con sfiato laterale.



Collaudo
100%

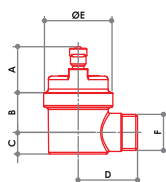

CODICE	MISURA	A	B	C	D	E	F	G	H	L			
67790417	G 3/8	14	41	9	34	40	G 3/8	-	-	-	160	10	100
67790421	G 1/2	14	41	9	34	40	G 1/2	-	-	-	160	10	100

**VS 606**

Valvola di sfogo aria automatica
con attacco laterale.



Collaudo
100%

CODICE	MISURA	A	B	C	D	E	F	G	H	L			
67790517	G 3/8	27	23	13	35	40	G 3/8	-	-	-	162	10	100
67790521	G 1/2	27	23	13	35	40	G 1/2	-	-	-	162	10	100

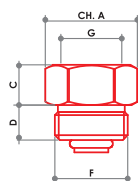
**VS 605**

Valvola di ritegno per valvola
automatica di sfogo aria.

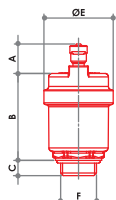

CODICE	MISURA	FINITURA	A	B	C	D	E	F	G	H	L			
67791200	G 3/8F x G 3/8M	GIALLA	19	-	12	9	-	G 3/8	G 3/8	-	-	18	100	800
67791400	G 3/8F x G 1/2M	GIALLA	23	-	12	9	-	G 1/2	G 3/8	-	-	40	100	800
67791600	G 1/2F x G 1/2M	GIALLA	23	-	12	9	-	G 1/2	G 1/2	-	-	30	100	800
67791200N	G 3/8F x G 3/8M	NICHELATA	19	-	12	9	-	G 3/8	G 3/8	-	-	18	100	800
67791400N	G 3/8F x G 1/2M	NICHELATA	23	-	12	9	-	G 1/2	G 3/8	-	-	40	100	800
67791600N	G 1/2F x G 1/2M	NICHELATA	23	-	12	9	-	G 1/2	G 1/2	-	-	30	100	800

**VS 604/S**

Valvola sfogo aria automatica.
200°C - 10 bar.



Collaudo
100%

CODICE	MISURA	A	B	C	D	E	F	G	H	L			
67791017	G 3/8	17	50	9	-	40	G 3/8	-	-	-	138	10	100
67791021	G 1/2	17	50	9	-	40	G 1/2	-	-	-	138	10	100

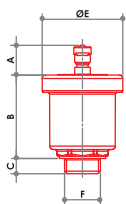
**VS 601/S**

Valvola di sfogo aria automatica tipo medio. 200°C - 10 bar.



Collaudo
100%

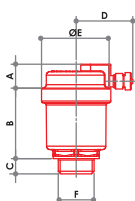

CODICE	MISURA	A	B	C	D	E	F	G	H	L			
67790817	G 3/8	17	50	9	-	46	G 3/8	-	-	-	154	10	100
67790821	G 1/2	17	50	9	-	46	G 1/2	-	-	-	154	10	100
67790827	G 3/4	17	50	9	-	46	G 3/4	-	-	-	154	10	100

**VS 603/S**

Valvola sfogo aria automatica con sfiato laterale. 200°C - 10 bar.



Collaudo
100%

CODICE	MISURA	A	B	C	D	E	F	G	H	L			
67790917	G 3/8	14	41	9	34	40	G 3/8	-	-	-	160	10	100
67790921	G 1/2	14	41	9	34	40	G 1/2	-	-	-	160	10	100

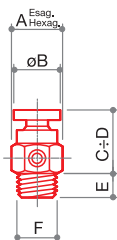
**VS 610**

Valvolina manuale per sfogo aria con volantino in ottone.



Collaudo
100%

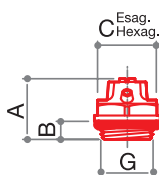

CODICE	MISURA	A	B	C	D	E	F	G	H	L			
67793000	G 1/8	13	14	20	23	7	G 1/8	-	-	-	20	100	800
67793500	G 1/4	13	14	17	19	7	G 1/4	-	-	-	20	100	800
67794000	G 3/8	16	14	17	19	7	G 3/8	-	-	-	30	100	800

**VS 620**

Valvolina manuale per sfogo aria con parte superiore in ABS colore bianco, o-ring di tenuta sul filetto, con possibilità di rotazione dello scarico.



Collaudo
100%

CODICE	MISURA	A	B	C	D	E	F	G	H	L			
67795417	G 3/8	21	7	19	-	-	-	G 3/8	-	-	21	100	800
67795421	G 1/2	21	8	22	-	-	-	G 1/2	-	-	24	100	800

**CH 620**

Chiave a farfalla per valvolina VS 620.

CODICE	MISURA			
67795400	-	1	200	-

VALVOLE DI SICUREZZA



CARATTERISTICHE TECNICHE

			
Campo di temperatura	Pressione di esercizio	Sovrappressione apertura	Scarto di chiusura
5 ÷ 110 °C	secondo taratura	20%	20%

CARATTERISTICHE COSTRUTTIVE

Le valvole di sicurezza vengono utilizzate per il controllo della pressione sui generatori di calore negli impianti di riscaldamento, sugli accumuli di acqua calda negli impianti idrosanitari e negli impianti idrici. La valvola si apre quando viene raggiunta la pressione di taratura e, tramite lo scarico in atmosfera, impedisce alla pressione dell'impianto di raggiungere limiti pericolosi per i componenti presenti nell'impianto stesso.

PRINCIPIO DI FUNZIONAMENTO

L'otturatore è in contrasto con una molla tarata in acciaio C72 che viene precaricata in base alla pressione di taratura, scelta in funzione della massima pressione ammissibile nell'impianto. Questo otturatore si solleva al raggiungimento della pressione di taratura e apre completamente il passaggio di scarico, mentre al diminuire della pressione si ha l'azione inversa, con la chiusura della valvola entro le tolleranze imposte. Il diametro dell'attacco in uscita della valvola deve essere uguale o maggiore per facilitare lo scarico della potenzialità richiesta. Le valvole di sicurezza ordinarie, secondo le normative italiane, possono essere applicate su generatori con potenzialità inferiore a 35 kW.



INSTALLAZIONE

Le valvole di sicurezza possono essere montate in posizione verticale od orizzontale ma non capovolte per evitare che si possa depositare delle impurità che causerebbero un cattivo funzionamento. Le valvole di sicurezza devono essere installate sulla sommità del generatore o sulla tubazione di mandata più vicina possibile al generatore, oppure entro la distanza massima dove specificata dalle normative applicabili. La tubazione di collegamento della valvola di sicurezza al generatore non deve essere intercettabile. Prima dell'installazione di una valvola di sicurezza è necessario che ne sia eseguito un corretto dimensionamento secondo le normative vigenti per le specifiche applicazioni. È vietato farne utilizzo diverso rispetto alla sua destinazione d'uso. L'installazione delle valvole di sicurezza deve essere eseguita da parte di personale tecnico qualificato secondo la normativa vigente. La valvola di sicurezza deve essere installata rispettando il senso di flusso indicato dalla freccia riportata sul corpo valvola.



VS 910



Valvola di sicurezza ordinaria a membrana 1/2 x 1/2 F/F.

CODICE	MISURA	bar			
67795001	1/2 x 1/2 F/F	1,5	110	10	100
67795002		1,8	110	10	100
67795003		2	110	10	100
67795004		2,5	110	10	100
67795005		3	110	10	100
67795006		3,5	110	10	100
67795007		4	110	10	100
67795008		5	110	10	100
67795009		6	110	10	100
67795010		7	110	10	100
67795011		8	110	10	100
67795012		10	110	10	100





VS 911

Valvola di sicurezza ordinaria a membrana 1/2 x 1/2 M/F.

CODICE	MISURA	bar			
67795014	1/2 x 1/2 M/F	1,5	120	10	100
67795015		1,8	120	10	100
67795016		2	120	10	100
67795017		2,5	120	10	100
67795018		3	120	10	100
67795019		3,5	120	10	100
67795020		4	120	10	100
67795021		5	120	10	100
67795022		6	120	10	100
67795023		7	120	10	100
67795024		8	120	10	100
67795025		10	120	10	100



**VS 920**

Valvola di sicurezza ordinaria a membrana 3/4 x 3/4 F/F.

CODICE	MISURA	bar			
67795027	3/4 x 3/4 F/F	1,5	170	10	100
67795028		1,8	170	10	100
67795029		2	170	10	100
67795030		2,5	170	10	100
67795031		3	170	10	100
67795032		3,5	170	10	100
67795033		4	170	10	100
67795034		6	170	10	100
67795035		7	170	10	100
67795036		8	170	10	100
67795037	10	170	10	100	



**VS 930**

Valvola di sicurezza ordinaria a membrana 1" x 1" F/F.

CODICE	MISURA	bar			
67795039	1" x 1" F/F	1,5	250	10	100
67795040		1,8	250	10	100
67795041		2,5	250	10	100
67795042		3	250	10	100
67795043		4	250	10	100
67795044		6	250	10	100



**VS 912**

Valvola di sicurezza ordinaria a membrana 1/2 x 1/2 F/F con attacco da 1/4 per manometro.

CODICE	MISURA	bar			
67795046	1/2 x 1/2 F/F	1,5	130	10	100
67795047		1,8	130	10	100
67795048		2	130	10	100
67795049		2,5	130	10	100
67795050		3	130	10	100
67795051		3,5	130	10	100
67795052		4	130	10	100
67795053		6	130	10	100

**VS 913**

Valvola di sicurezza ordinaria a membrana 1/2 x 1/2 M/F con attacco da 1/4 per manometro.

CODICE	MISURA	bar			
67795055	1/2 x 1/2 M/F	1,5	135	10	100
67795056		1,8	135	10	100
67795057		2	135	10	100
67795058		2,5	135	10	100
67795059		3	135	10	100
67795060		3,5	135	10	100
67795061		4	135	10	100
67795062		6	135	10	100

VALVOLA MISCELATRICE



IMPIEGO

La valvola a tre vie VM 652 può essere impiegata come valvola deviatrice o miscelatrice per impianti di riscaldamento e condizionamento con utilizzo di acqua o soluzione acquaglicole **max 30%**. La valvola VM 650 è costruita per l'impiego specifico nei sistemi di riscaldamento a pannello radiante. Il suo funzionamento è simile a quello di una valvola termostatica a 2 vie con il bypass aperto sul ritorno del pannello radiante. La via B-AB è sempre aperta. Le valvole a tre vie serie VM sono normalmente aperte e possono essere impiegate con la testa termostatica art TT 2351 come miscelatrici a punto fisso in impianti di riscaldamento o comandate elettricamente con teste serie TE e motori serie SM.

PECULIARITÀ

Le valvole serie VM presentano:

- Elevati valori di Kvs.
- Possibilità di una precisa modulazione grazie alla corsa e alla forma dell'otturatore, che consente di aprire immediatamente sia il passaggio diretto che il bypass, garantendo una modulazione dei flussi in un campo pari all'intera corsa. (VM 652)
- Bassissimo trafileamento anche se utilizzate in impianti con alta pressione differenziale.

CARATTERISTICHE TECNICHE

Max trafileamento ammesso con ΔP max

- 0.05% del Kvs per il passaggio diretto
- 0.1% del Kvs per il bypass

Kvs attraverso il bypass inferiore del 30% circa del passaggio diretto

Via A-AB portata Kvs 3.5 - Massima ΔP ammesso 0.8 bar

Via B-AB portata Kvs 2.6 - Massima ΔP ammesso 1.8 bar



Max temperatura

120 °C



Max pressione

16 bar



Materiale parti stampate
CW617N
UNI EN
12165:2016



Materiale otturatore
CW614N
UNI EN
12164:2016



Materiale parti acciaio inox
AISI 303



Guarnizioni OR

EPDM

FUNZIONAMENTO

Le valvole miscelatrici VM 650-652 possono essere installate in posizione verticale o orizzontale, senza alcuna limitazione. Rispettare le connessioni indicate sul corpo e in figura.

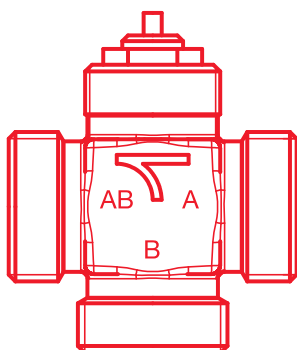

VM 650		VM 652			
MISCELATRICE		MISCELATRICE		DEVIATRICE	
A	ingresso fluido 1	A	ingresso fluido 1	AB	ingresso fluido
B	ingresso fluido 2	B	ingresso fluido 2	A	uscita fluido 1
AB	miscelato (via B-AB di bypass)	AB	miscelato	B	uscita fluido 2
Kvs (m ³ /h)		Kvs (m ³ /h)		Kvs (m ³ /h)	
A-AB = 3,5		A-AB = 3,5		AB-A = 3,9	
B-AB = 2,6		B-AB = 2,6		AB-B = 2,8	
ΔP MAX (bar)		ΔP MAX (bar)		ΔP MAX (bar)	
A-AB = 0,8		A-AB = 0,8		AB-A = 3,5	
B-AB = -		B-AB = 1,8		AB-B = 1	

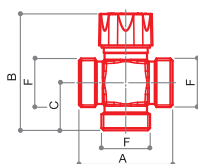

VM 650

Valvola miscelatrice termostattabile con miscelazione laterale e terza via di bypass.

CODICE	MISURA	A	B	C	D	E	F	G	H	L			
68753411	G 1"	64	80	35	-	-	G 1"	-	-	-	346	1	30

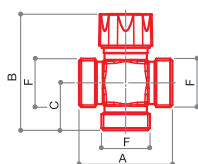

VM 652

Valvola miscelatrice termostattabile con miscelazione laterale.

CODICE	MISURA	A	B	C	D	E	F	G	H	L			
68753413	G 1"	64	80	35	-	-	G 1"	-	-	-	260	1	30

VALVOLE DEVIATRICI DI ZONA



CARATTERISTICHE COSTRUTTIVE

Le valvole deviatrici di zona VZ sono in ottone, robuste e realizzate appositamente per essere automatizzate facilmente e velocemente con attuatori elettrici, compatte, in grado di essere posizionate anche in cassette con una profondità di 80mm.

CARATTERISTICHE TECNICHE

Limiti di temperatura (valvola)	Limiti di temperatura (attuatore)	Pressione di esercizio
-20 °C ÷ +80 °C	-20 °C ÷ +70 °C	vedi grafico sotto

SCHEMI IDRAULICI

VZ702
Schema a tre vie bypass



DIAGRAMMA MASSIMA PRESSIONE DI ESERCIZIO/TEMPERATURA

(prova eseguita con acqua)

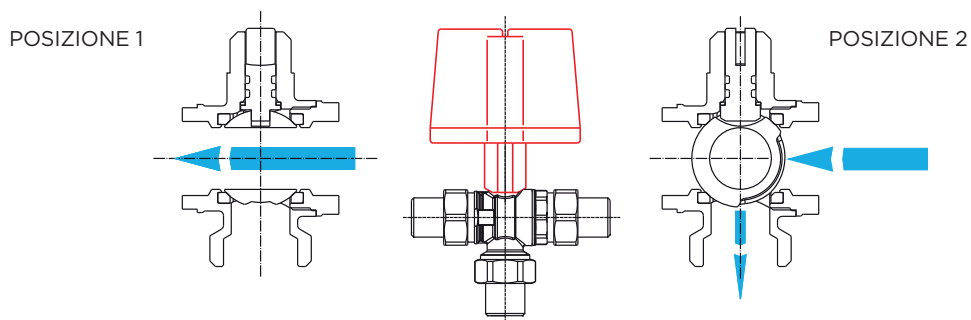
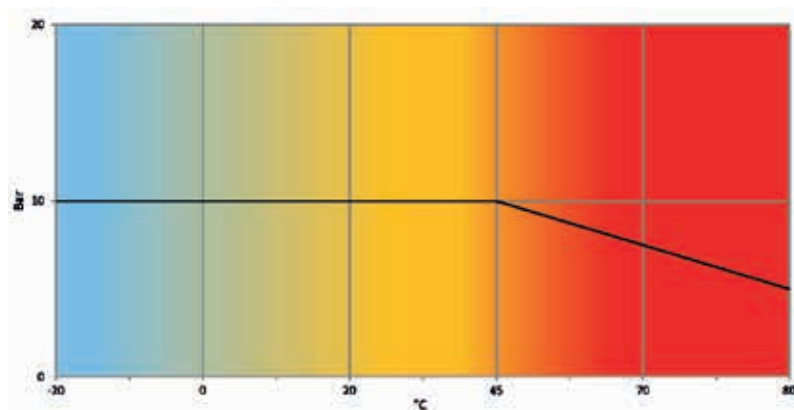

CARATTERISTICHE ATTUATORE

Voltaggio	230V 50-60Hz
Potenza assorbita	46 VA
Segnale ingresso	2 Punti / SPST / On-Off / con relay interno
Attacco per valvole	Quick Mounting (Attacco rapido)
Tempo di azionamento	12 Sec
Peso	0,3 Kg
Tipologia di motore	Bidirezionale

Angolo di rotazione	90°
Grado di protezione	IP54
Temperatura di esercizio	-20 / +70 °C
Connessione	Cavo multifilare 5 fili
Contatto ausiliario	250V 0.5A (AC1)
Kvs 3/4 2vie	41
Kvs 1" 2vie	70

COLLEGAMENTI ELETTRICI

SM700

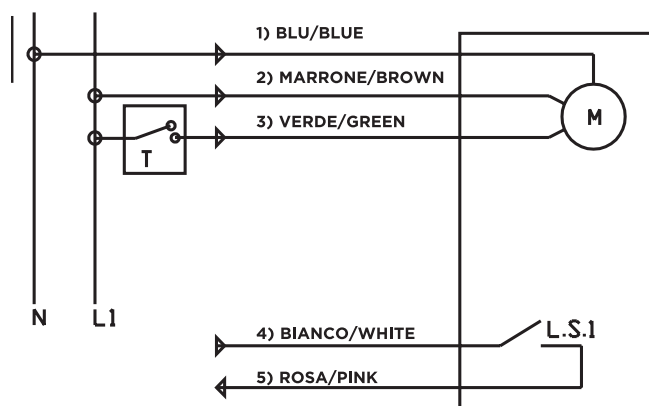

- 1 BLU** - neutro 230V 50/60Hz
2 MARRONE - fase 230V 50/60Hz
3 VERDE - fase per aprire / disconnesso per chiudere
4 BIANCO - comune contatto ausiliario
5 ROSA - contatto ausiliario n.o.

- N** - neutro (sn)
L1 - fase (sp)
T - termostato (relay)
L.S.1 - contatto ausiliario

COLORE FILO	DIREZIONE	FUNZIONE	DESCRIZIONE	CONNESSIONE
Blu	Entrata	Alimentazione	Neutro (sn)	Collegare al neutro
Marrone	Entrata	Alimentazione	Fase (sp)	Collegare alla fase
Verde	Entrata	Comando Termostato	Aperto chiuso (y1)	Se connesso alla fase la valvola apre; se non connesso alla fase la valvola chiude
Bianco/Rosa	Uscita	Uscita ausiliare	Contatto pulito	Se la valvola è aperta i 2 fili sono cortocircuitati

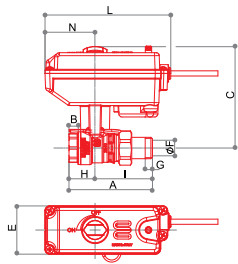

VZ 700

Valvola di zona F-M con servomotore elettrico compatto.

CODICE	MISURA	A	B	C	E	F	G	H	I	L	N			
68812700	G 3/4	91	11	102	46.5	20	12	29	62	121	48	1250	1	-
68813400	G 1"	104.5	12.5	106	46.5	25	12	35	69.5	121	48	1430	1	-

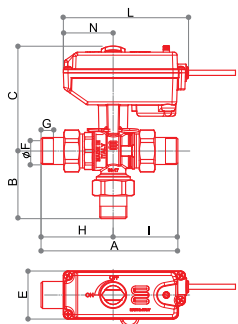

VZ 702

Valvola di zona M-M-M con servomotore elettrico compatto.

CODICE	MISURA	A	B	C	D	E	F	H	I	L	N			
68822700	G 3/4	132.5	65.5	102	165.5	46.5	20	62.5	70	121	48	1480	1	-
68823400	G 1"	151	70	106	175	46.5	25	70	81	121	48	1950	1	-

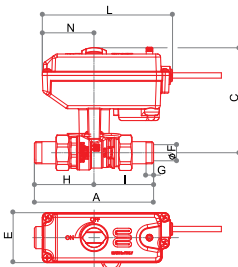

VZ 704

Valvola di zona M-M con servomotore elettrico compatto.

CODICE	MISURA	A	B	C	E	F	G	H	I	L	N			
68842700	G 3/4	130	-	102	46.5	20	12	68	62	121	48	1155	1	-
68843400	G 1"	147	-	106	46.5	25	12	77.5	69.5	121	48	1414	1	-

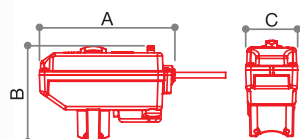

SM 700

Servomotore elettrico per valvole di zona VZ 700, VZ 702 e VZ 704.

CODICE	MISURA	A	B	C	D	E			
69011720	230 V - ON/OFF	121	86	46.5	-	-	480	1	-

DEMAX

DEFANGATORE MAGNETICO PER IMPIANTI DI RISCALDAMENTO



**CATTURA LE IMPURITÀ
ED EVITA OSTRUZIONI**

Le tematiche connesse al risparmio energetico e all'utilizzo razionale delle risorse sono sempre più di maggior attualità; per cui si rende necessario mantenere efficiente il circuito di riscaldamento utilizzando un filtro defangatore magnetico posto sul condotto di ritorno per catturare le impurità presenti nel fluido termovettore ed evitando eventuali danneggiamenti che queste possono provocare all'impianto di riscaldamento. Questo dispositivo deve essere installato sul circuito di riscaldamento e una volta posizionato, è necessario effettua-

re nuovamente il riempimento dell'impianto di riscaldamento sfogando l'aria in eccesso.

Le principali caratteristiche tecniche sono:

- Evita il pericolo di formazione di ostruzioni ed intasamenti delle tubazioni circuito di riscaldamento e dei suoi componenti.
- Nel caso di sostituzione della caldaia, il filtro defangatore è applicabile anche su quella nuova.

CARATTERISTICHE TECNICHE



Max temperatura
65 °C



Temperatura ambiente
+5°C ...+ 50°C



Pressione di esercizio acqua:
1,0 ÷ 2,0 bar



Pressione massima acqua:
3,0 bar

Contenuto di acqua circuito riscald.: ~ 0,2 l

Magnete: Ø12x60 mm, 4500 gauss

Larghezza: 101,5 mm

Altezza: 116,5 mm

Peso a vuoto: 175 g

Raccorderia in dotazione: G3/4

SCHEMA DI FUNZIONAMENTO

Il filtro defangatore prevede due diverse configurazioni di installazione per potersi adattare alla maggioranza dei circuiti idraulici domestici esistenti oppure nuovi.

- 1) Ritorno impianto riscaldamento / ingresso filtro
- 2) Uscita filtro defangatore / verso ritorno caldaia
- 3) Sede per tappo cieco G3/4 femmina
- 4) Sede per tappo cieco M12 in plastica grigia per svuotamento filtro.

**Configurazione
con filtro in orizzontale**

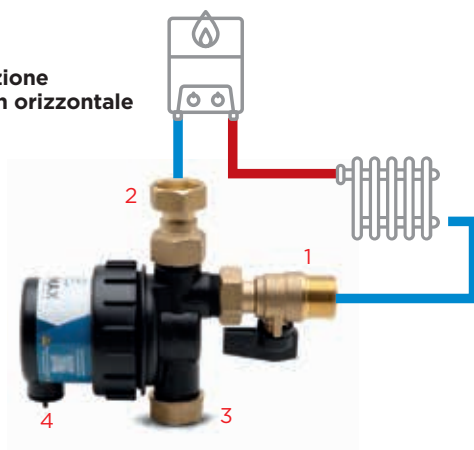

**Configurazione
con filtro in verticale**



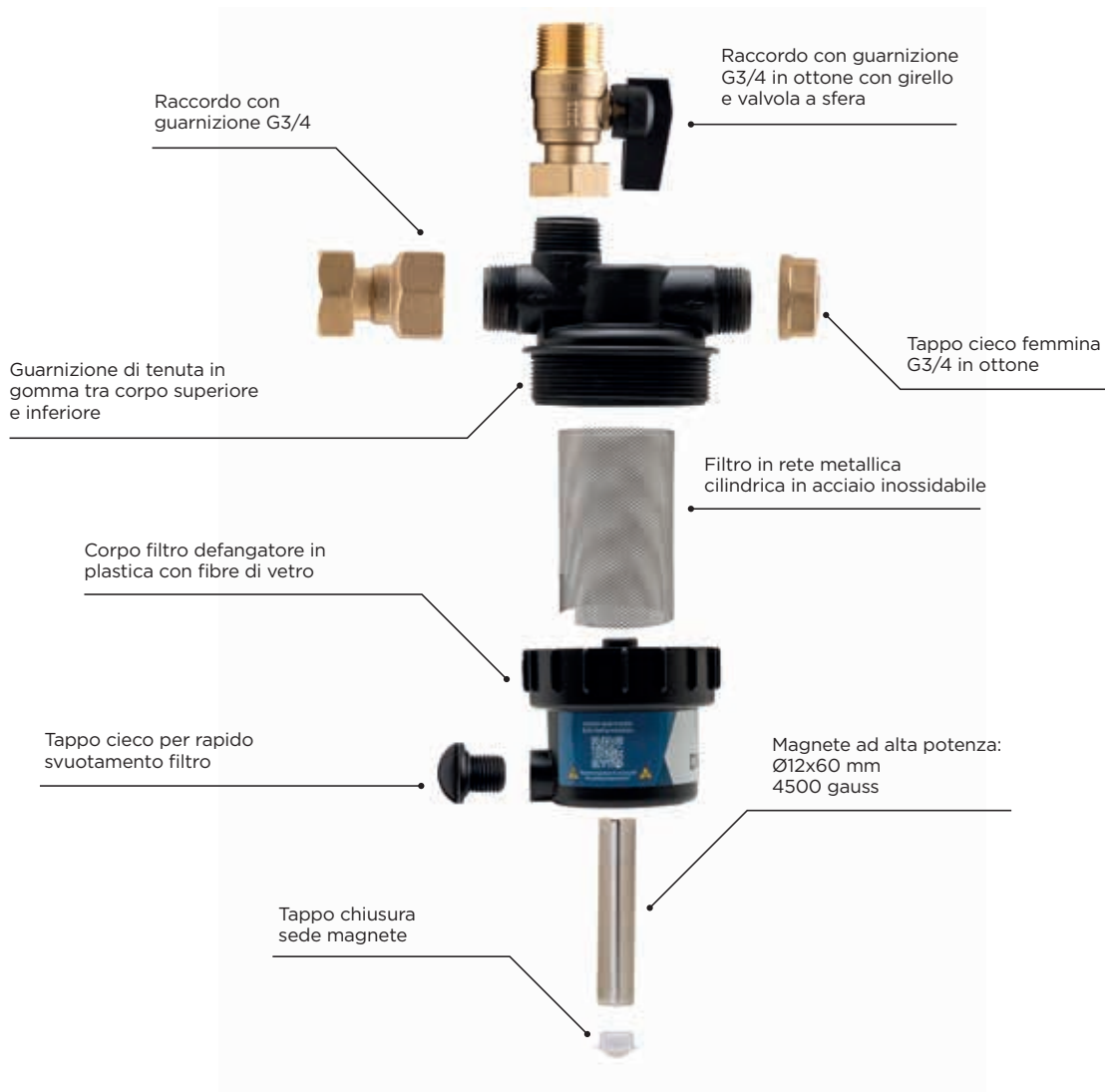

PRINCIPIO DI FUNZIONAMENTO

L'acqua di ritorno dall'impianto di riscaldamento, viene collegata al raccordo d'ingresso del filtro defangatore, successivamente l'acqua attraversa la zona interna dove è presente il magnete e la rete metallica in acciaio inossidabile ed esce dal raccordo di uscita del filtro defangatore.

DEFANGATORE MAGNETICO PER IMPIANTI DI RISCALDAMENTO



DM 2018

Defangatore magnetico per impianti di riscaldamento.

CODICE	MISURA			
68550010	G 3/4	542	1	6



4 / GRUPPI PREMONTATI

GRUPPI DI RILANCIO E DI MISCELAZIONE

**GM 1197**

Gruppo di miscelazione regolabile a punto fisso con sensore integrato. Adatto per circolatori da G 1" 1/2 interasse 130 mm e collettori staffati G 1" interasse 200 mm. Completo di termostato di sicurezza con pozzetto ad immersione.

CODICE	MISURA			
72000310	G 1"	2334	1	8

**GM 1195**

Gruppo di miscelazione regolabile a punto fisso. Adatto per circolatori da G 1" 1/2 interasse 130 mm e collettori staffati G 1" interasse 200 mm.

CODICE	MISURA			
72000300	G 1"	2184	1	8

**GR 1194**

Gruppo di rilancio adatto per circolatori da G 1" 1/2 interasse tra 130 mm e 180 mm. Staffe regolabili tra i 200 mm e i 250 mm per collettori in acciaio e ottone. Bypass differenziale con regolazione tra 0,2 e 0,7 bar. Attacchi al collettore da G 1".

CODICE	MISURA			
72000320	G 1"	2703	1	-

SISTEMI DI REGOLAZIONE PER IMPIANTI A PANNELLI RADIANTI CON IL GRUPPO POMPA GP 1190



20 kW

CARATTERISTICHE TECNICHE

Pressione massima di esercizio 6 bar
Pressione massima differenziale 1 bar
Temperatura massima di esercizio 120 °C

CARATTERISTICHE TECNICHE SISTEMA CON GP 1190

Pressione massima di esercizio 6 bar
Pressione massima differenziale 1 bar
Temperatura massima di esercizio 70 °C
Intervallo di temperatura sul secondario 20 °C ÷ 65 °C
Potenza termica massima 20 kW con un Δt di 10 °C
e temperatura del primario ≥ 70 °C

CARATTERISTICHE COSTRUTTIVE

Le parti stampate sono in ottone a basso contenuto di piombo in conformità con le normative CW617N UNI EN 12165:2016. Tutte le guarnizioni o-ring sono in EPDM perossidico. Le parti in acciaio inox sono in AISI 316. Tutti i componenti sono dotati di tenuta morbida o-ring, non necessitano di alcun elemento intermedio di sigillatura (es. PTFE, canapa, ecc).

Attacchi laterali da W24x19 o da G 3/4 Ek con interassi da 50 mm. Il gruppo pompa GP 1190 ha un passaggio interno pari a un \varnothing 23 mm.

IMPIEGO

Il sistema per il riscaldamento a punto fisso ha il vantaggio di essere particolarmente compatto e di sfruttare tutti i componenti di serie dei collettori Luxor già in commercio e già noti, con l'aggiunta di 2 soli articoli specifici:

- art. GP 1190;
- art. TT 3051.

Questo sistema permette di ottenere, in maniera semplice e conveniente, un impianto di riscaldamento misto in quelle unità abitative dove sono presenti sia corpi scaldanti ad alta temperatura (60 °C ÷ 70 °C), sia circuiti a pannelli radianti da alimentare con acqua a bassa temperatura (20 °C ÷ 50 °C).

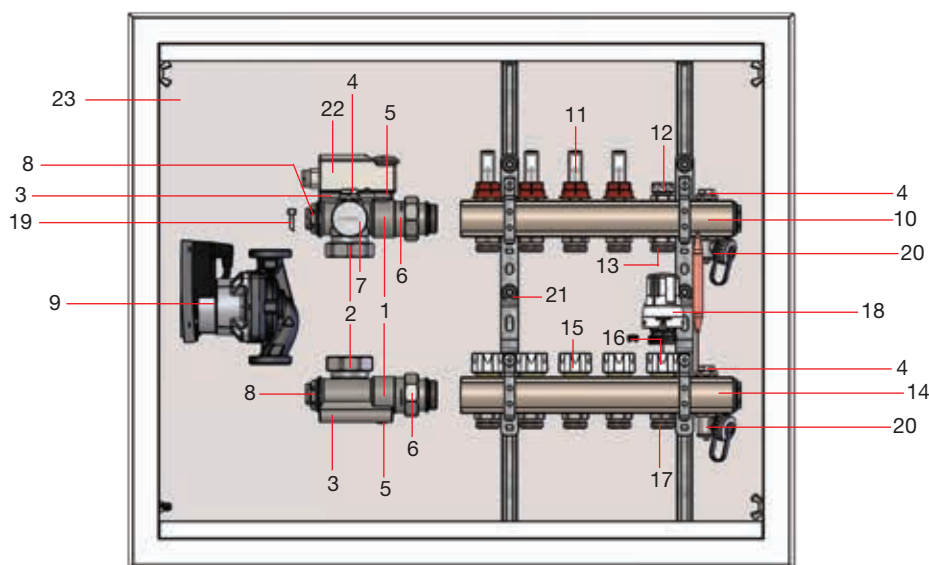

COMPONENTI

- | | |
|---|---|
| <p>1 Gruppo pompa</p> <p>2 Collegamenti alla pompa di circolazione con dado girevole da G 1"1/2</p> <p>3 Alloggiamenti per la sonda di regolazione della testa termostatica e predisposizione per l'alloggiamento del sensore del termostato di sicurezza</p> <p>4 Valvola di sfogo aria manuale</p> <p>5 Valvole a sfera per l'intercettazione della pompa</p> <p>6 Raccordi da G 1" con tenuta morbida</p> <p>7 Termometro per la rilevazione delle temperatura impostata</p> <p>8 Attacchi da G 1/2 femmina per eventuali strumenti</p> <p>9 Pompa di circolazione con motore sincrono 25/60 interasse 130 mm in classe energetica A</p> <p>10 Collettore di mandata ai pannelli radianti</p> <p>11 Regolatori e misuratori di portata, con capacità da 0,5 l/min a 5 l/min. In caso lo sporco impedisse la lettura della portata, è possibile smontare e pulire il bicchiere con l'impianto in funzione</p> | <p>12 Valvola di intercettazione del circuito a bassa temperatura</p> <p>13 Attacco per il ritorno in caldaia</p> <p>14 Collettore di ritorno dei pannelli radianti</p> <p>15 Valvole predisposte per la regolazione elettrotermica con cappucci di protezione</p> <p>16 Valvola di regolazione termostattizzabile</p> <p>17 Attacco mandata dalla caldaia</p> <p>18 Testa termostatica con sensore a distanza</p> <p>19 Molla per il fissaggio della sonda a distanza della testa termostatica</p> <p>20 Rubinetto di carico e scarico acqua</p> <p>21 Staffe</p> <p>22 Termostato di sicurezza bimetallico a contatto</p> <p>23 Cassetta con piedi regolabili, cornice e porta bianchi RAL 9016</p> |
|---|---|

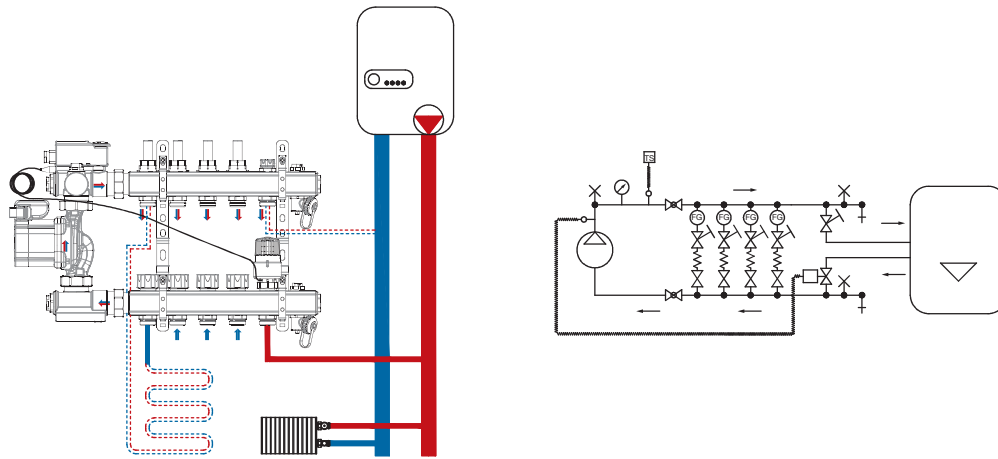

LEGENDA SCHEMI IDRAULICI

	valvola intercettazione		rubinetto di carico o scarico acqua		pompa circolazione
	valvola sfera		termometro		utilizzatore: pannelli radianti, termoarredi ecc.
	valvola non ritorno, la freccia indica il senso di flusso		dispositivo di sfogo aria manuale		filtro
	valvola di sicurezza (valvola di bypass)		dispositivo di sfogo aria automatico		valvola a 3 vie
	valvola intercettazione, regolazione e bilanciamento		misuratore di portata		
	valvola a sfera d'intercettazione, regolazione e bilanciamento		termostato di sicurezza ad immersione		
	valvola di iniezione con sensore a distanza		termostato di sicurezza a contatto		

FUNZIONAMENTO

Il sistema per il riscaldamento a punto fisso mantiene costante a un valore impostato la temperatura dell'acqua nei pannelli radianti, miscelando l'acqua ad alta temperatura in arrivo dalla caldaia con quella in circolazione nei pannelli stessi.

Una valvola termostatica con sonda a distanza rileva la temperatura e, in base al valore rilevato, integra il circuito di una quantità di acqua ad alta temperatura, tale da compensare la potenza termica ceduta dai pannelli radianti.

Si consiglia comunque di montare sulla valvola in ingresso alla pompa un termostato di sicurezza, al fine di evitare danni dovuti a un innalzamento imprevisto della temperatura.

L'intervento del termostato di sicurezza deve bloccare il funzionamento della pompa.

Il sistema può essere integrato con una valvola di bypass che, in presenza di una eccessiva pressione differenziale, scarichi la prevalenza in esubero salvaguardando i componenti dell'impianto e, nel caso siano utilizzate teste termoelettriche per l'intercettazione dei circuiti, eviti fenomeni di rumore e usura della pompa di circolazione.

Questo tipo di impianto riesce a fornire una potenza termica massima di 20 kW con un Δt di 10°C e una temperatura del primario ≥ 70 °C.

**SISTEMI DI REGOLAZIONE PER IMPIANTI A PANNELLI RADIANTI
CON IL GRUPPO POMPA GP 1190**
**GP 1190**

Valvola da G 1" attacco pompa per sistema di riscaldamento misto, temperatura massima del termometro 80 °C.



CODICE	MISURA			
72000030	G 1"	2107	1	8

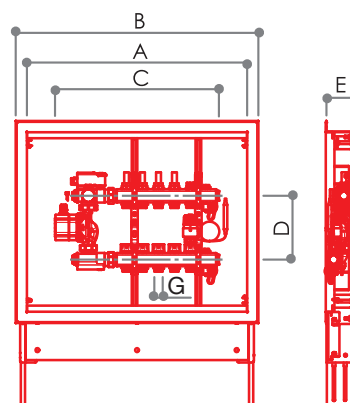

 Profondità
90 mm

**CCBP 4022**

Impianto con distribuzione a punto fisso bassa (W24x19).

ARTICOLO	CODICE	MISURA	N. ATTACCHI PANNELLI	A	B	C	D	E	F	G	H	L		
CCBP4022/2	17402202N	G 1" x (W24x19)	2	500	560	420	200	90	-	W24x19	-	-	17,312	1
CCBP4022/3	17402203N		3	700	760	470			-		-	19,906	1	
CCBP4022/4	17402204N		4	700	760	520			-		-	20,500	1	
CCBP4022/5	17402205N		5	700	760	570			-		-	21,094	1	
CCBP4022/6	17402206N		6	700	760	620			-		-	21,688	1	
CCBP4022/7	17402207N		7	850	910	670			-		-	24,282	1	
CCBP4022/8	17402208N		8	850	910	720			-		-	24,876	1	
CCBP4022/9	17402209N		9	850	910	770			-		-	25,470	1	
CCBP4022/10	17402210N		10	1000	1060	820			-		-	28,064	1	
CCBP4022/11	17402211N		11	1000	1060	870			-		-	28,658	1	



Profondità
90 mm

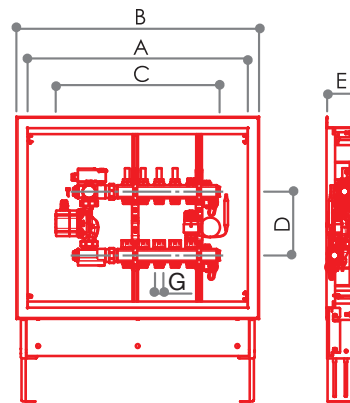

CCBP 4032

Impianto con distribuzione a punto
fisso bassa G 3/4 EK.

ARTICOLO	CODICE	MISURA	N. ATTACCHI PANNELLI	A	B	C	D	E	F	G	H	L		
CCBP4032/2	17403202N	G 1" x G 3/4 EK	2	500	560	420	200	90	-	G 3/4 EK	-	-	17,312	1
CCBP4032/3	17403203N		3	700	760	470			-		-	19,906	1	
CCBP4032/4	17403204N		4	700	760	520			-		-	20,500	1	
CCBP4032/5	17403205N		5	700	760	570			-		-	21,094	1	
CCBP4032/6	17403206N		6	700	760	620			-		-	21,688	1	
CCBP4032/7	17403207N		7	850	910	670			-		-	24,282	1	
CCBP4032/8	17403208N		8	850	910	720			-		-	24,876	1	
CCBP4032/9	17403209N		9	850	910	770			-		-	25,470	1	
CCBP4032/10	17403210N		10	1000	1060	820			-		-	28,064	1	
CCBP4032/11	17403211N		11	1000	1060	870			-		-	28,658	1	

DIAGRAMMA DI PORTATA

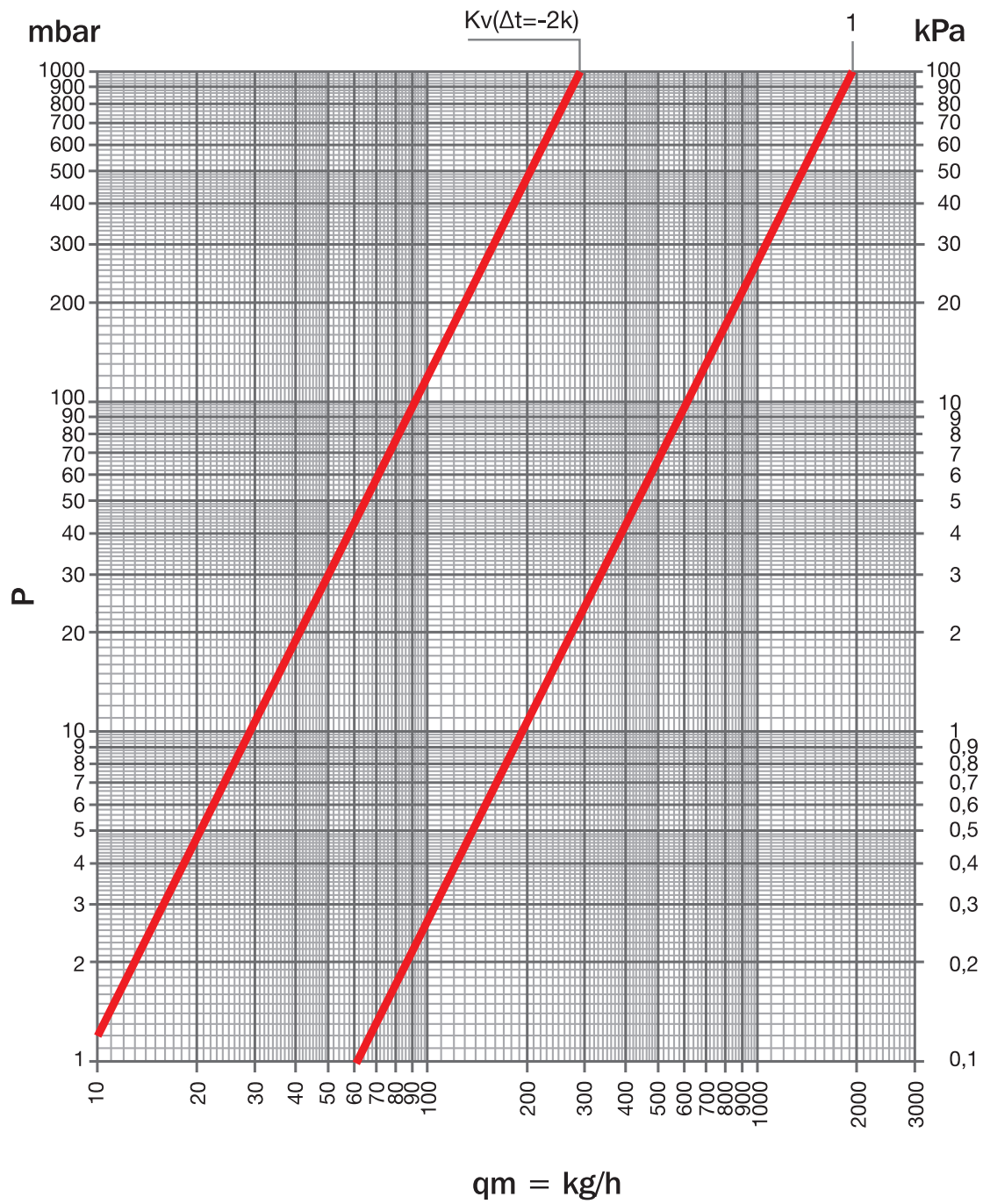

Kv	Kv Δt 2 °C	POS
1,92	00,29	1

SISTEMI DI REGOLAZIONE PER IMPIANTI A PANNELLI RADIANTI CON IL GRUPPO POMPA GP 1190 E KIT PER ALTA TEMPERATURA KA 1191



CARATTERISTICHE COSTRUTTIVE

Le parti stampate sono in ottone a basso contenuto di piombo in conformità con le normative, CW617N UNI EN 12165:2016. Tutte le guarnizioni o-ring sono in EPDM perossidico.

Le parti in acciaio inox sono in AISI 316.

Tutti i componenti sono dotati di tenuta morbida o-ring, non necessitano di alcun elemento intermedio di sigillatura (es. PTFE, canapa, ecc). Attacchi laterali da W24x19 o da G 3/4 EK con interassi da 50 mm.

Il gruppo pompa GP 1190 ha un passaggio interno pari a un \varnothing 23 mm.

14 kW

CARATTERISTICHE TECNICHE

Pressione massima di esercizio 6 bar

Pressione massima differenziale 1 bar

Temperatura massima di esercizio 80 °C

CARATTERISTICHE TECNICHE SISTEMA CON GP 1190 + KA 1191

Pressione massima di esercizio 6 bar

Pressione massima differenziale 1 bar

Temperatura massima di esercizio sul primario 80 °C

Temperatura massima di esercizio sul secondario 70 °C

Intervallo di temperatura sul secondario 20 °C ÷ 65 °C

Potenza termica massima 14 kW con un Δt di 10 °C

e temperatura del primario \geq 70 °C

IMPIEGO

Il kit per alta temperatura KA 1191, associato ai gruppi pompa GP 1190, permette di installare in un'unica cassetta sia la distribuzione di acqua calda per un impianto tradizionale a radiatori, sia la distribuzione di acqua per un impianto a pannelli radianti.

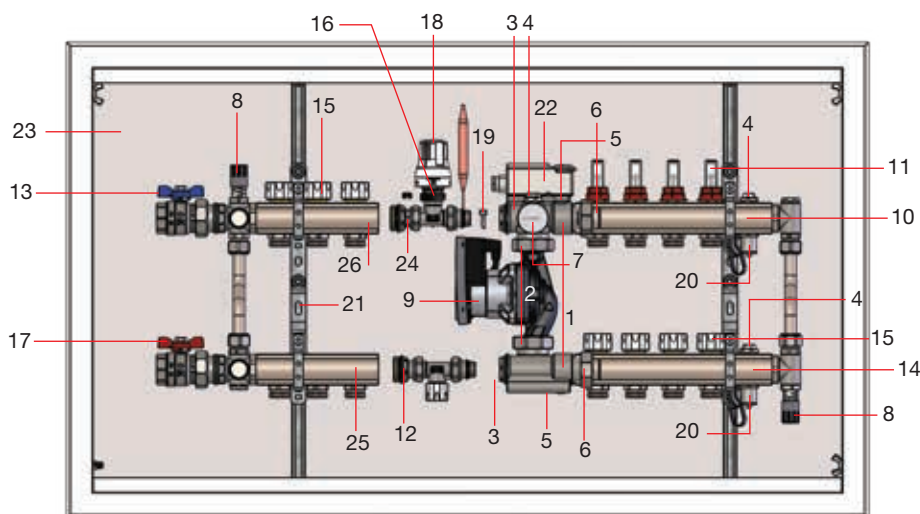





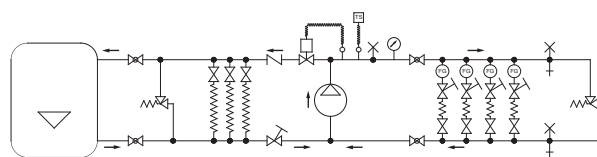
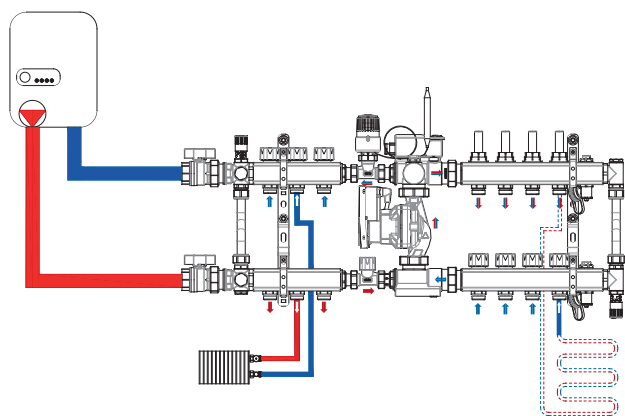

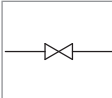
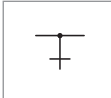

COMPONENTI

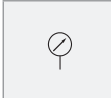
- | | |
|--|---|
| 1 Gruppo pompa | 12 Valvola di intercettazione del circuito a bassa temperatura |
| 2 Collegamenti alla pompa di circolazione con dado girevole da G 1"1/2 | 13 Valvola a sfera di ritorno alla caldaia |
| 3 Alloggiamenti per la sonda di regolazione della testa termostatica | 14 Collettore di ritorno dei pannelli radianti |
| 4 Valvola di sfogo aria manuale | 15 Valvole predisposte per la regolazione elettrotermica con cappucci di protezione |
| 5 Valvole a sfera per l'intercettazione della pompa | 16 Valvola di regolazione termostattizzabile |
| 6 Raccordi da G 1" con tenuta morbida | 17 Valvola a sfera di mandata dalla caldaia |
| 7 Termometro per la rilevazione delle temperatura impostata | 18 Testa termostatica con sensore a distanza |
| 8 Valvola di bypass differenziale | 19 Molla per il fissaggio della sonda a distanza della testa termostatica |
| 9 Pompa di circolazione con motore sincrono 25/60 interasse 130 mm in classe energetica A | 20 Rubinetto di carico e scarico acqua |
| 10 Collettore di mandata ai pannelli radianti | 21 Staffe |
| 11 Regolatori e misuratori di portata, con capacità da 0,5l/min a 5 l/min. In caso lo sporco impedisse la lettura della portata, è possibile smontare e pulire il bicchiere con l'impianto in funzione | 22 Termostato di sicurezza bimetallico a contatto |
| | 23 Cassetta con piedi regolabili, cornice e porta bianchi RAL 9016 |
| | 24 Valvola di ritegno |
| | 25 Collettore di mandata per il primario |
| | 26 Collettore di ritorno del primario |

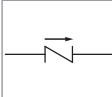

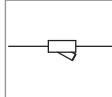
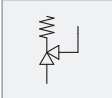
LEGENDA SCHEMI IDRAULICI

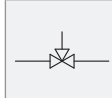
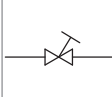
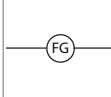
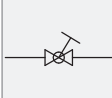
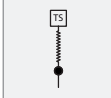
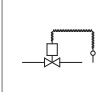
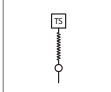
	valvola intercettazione		rubinetto di carico o scarico acqua		pompa circolazione
	valvola sfera		termometro		utilizzatore: pannelli radianti, termoarredi ecc.
	valvola non ritorno, la freccia indica il senso di flusso		dispositivo di sfogo aria manuale		filtro
	valvola di sicurezza (valvola di bypass)		dispositivo di sfogo aria automatico		valvola a 3 vie
	valvola intercettazione, regolazione e bilanciamento		misuratore di portata		
	valvola a sfera d'intercettazione, regolazione e bilanciamento		termostato di sicurezza ad immersione		
	valvola di iniezione con sensore a distanza		termostato di sicurezza a contatto		

FUNZIONAMENTO

L'acqua ad alta temperatura, proveniente dalla caldaia e dal circuito primario, entra nel gruppo pompa GP 1190, attraverso la valvola detentore d'intercettazione del kit KA 1191 che regola la massima quantità di fluido che deve entrare nel circuito secondario bilanciando quindi il primario.

La relativa acqua in uscita è controllata dalla valvola di regolazione termostattizzabile. Questa valvola viene controllata da una testa termostatica con sonda a distanza che mantiene costante ad un valore impostato la temperatura di mandata ai pannelli radianti, miscelando l'acqua ad alta temperatura della caldaia con quella in circolazione nei pannelli stessi.

Il sistema è integrato con una valvola di bypass sia sul circuito primario sia sul secondario, che in presenza di una eccessiva pressione differenziale scarichi la prevalenza in esubero salvaguardando i componenti dell'impianto e, nel caso siano utilizzate teste termoelettriche per l'intercettazione dei circuiti, eviti fenomeni di rumore e usura della pompa di circolazione. L'intervento del termostato di sicurezza deve bloccare il funzionamento della pompa.

Questo tipo di impianto riesce a fornire una potenza termica massima di 14 kW con un Δt di 10 °C e una temperatura del primario ≥ 70 °C.

**SISTEMI DI REGOLAZIONE PER IMPIANTI A PANNELLI RADIANTI
CON IL GRUPPO POMPA GP 1190 E KIT PER ALTA TEMPERATURA KA 1191**



KA 1191

Kit per alta associato al gruppo GP 1190.

CODICE	MISURA			
72000040	G 1"	787	1	8



Profondità 90 mm

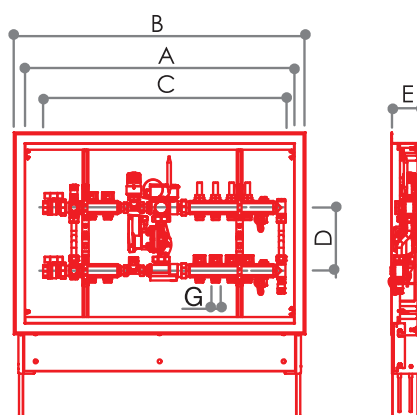

CCBAP 4024

Impianto con distribuzione bassa + 2 attacchi di alta (W24x19).

ARTICOLO	CODICE	MISURA	N. ATTACCHI PANNELLI	A	B	C	D	E	F	G				
CCBAP4024/2	17402402N	G 1" x (W24x19)	2	850	910	670	200	90		W24x19	24,648	1		
CCBAP4024/3	17402403N		3	850	910	720							25,242	1
CCBAP4024/4	17402404N		4	850	910	770							25,836	1
CCBAP4024/5	17402405N		5	1000	1060	820							28,430	1
CCBAP4024/6	17402406N		6	1000	1060	870							29,024	1
CCBAP4024/7	17402407N		7	1000	1060	920							29,618	1
CCBAP4024/8	17402408N		8	1200	1260	970							32,212	1
CCBAP4024/9	17402409N		9	1200	1260	1020							32,806	1
CCBAP4024/10	17402410N		10	1200	1260	1070							33,400	1
CCBAP4024/11	17402411N		11	1200	1260	1120							33,994	1
CCBAP4024/12	17402412N		12	1300	1360	1170							36,588	1



Profondità 90 mm

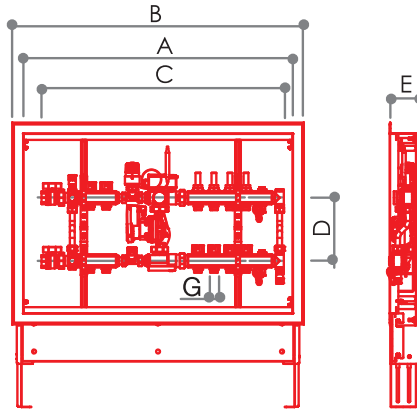

CCBAP 4023

Impianto con distribuzione bassa + 3 attacchi di alta (W24x19).

ARTICOLO	CODICE	MISURA	N. ATTACCHI PANNELLI	A	B	C	D	E	F	G		
CCBAP4023/2	17402302N	G 1" x (W24x19)	2	850	910	720	200	90	-	W24x19	25,218	1
CCBAP4023/3	17402303N		3	850	910	770			-		25,812	1
CCBAP4023/4	17402304N		4	1000	1060	820			-		28,406	1
CCBAP4023/5	17402305N		5	1000	1060	870			-		29,000	1
CCBAP4023/6	17402306N		6	1000	1060	920			-		29,594	1
CCBAP4023/7	17402307N		7	1200	1260	970			-		32,188	1
CCBAP4023/8	17402308N		8	1200	1260	1020			-		32,782	1
CCBAP4023/9	17402309N		9	1200	1260	1070			-		33,376	1
CCBAP4023/10	17402310N		10	1200	1260	1120			-		33,970	1
CCBAP4023/11	17402311N		11	1300	1360	1170			-		36,564	1
CCBAP4023/12	17402312N		12	1300	1360	1220			-		37,158	1



Profondità 90 mm

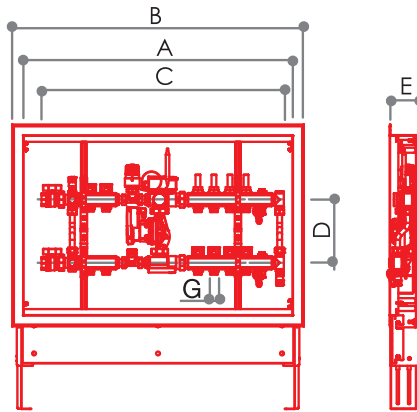

CCBAP 4034

Impianto con distribuzione bassa + 2 attacchi di alta (G 3/4 EK).

ARTICOLO	CODICE	MISURA	N. ATTACCHI PANNELLI	A	B	C	D	E	F	G		
CCBAP4034/2	17403402N	G 1" x G 3/4 EK	2	850	910	670	200	90	-	G 3/4 EK	24,648	1
CCBAP4034/3	17403403N		3	850	910	720			-		25,242	1
CCBAP4034/4	17403404N		4	850	910	770			-		25,836	1
CCBAP4034/5	17403405N		5	1000	1060	820			-		28,430	1
CCBAP4034/6	17403406N		6	1000	1060	870			-		29,024	1
CCBAP4034/7	17403407N		7	1000	1060	920			-		29,618	1
CCBAP4034/8	17403408N		8	1200	1260	970			-		32,212	1
CCBAP4034/9	17403409N		9	1200	1260	1020			-		32,806	1
CCBAP4034/10	17403410N		10	1200	1260	1070			-		33,400	1
CCBAP4034/11	17403411N		11	1200	1260	1120			-		33,994	1
CCBAP4034/12	17403412N		12	1300	1360	1170			-		36,588	1



Profondità
90 mm

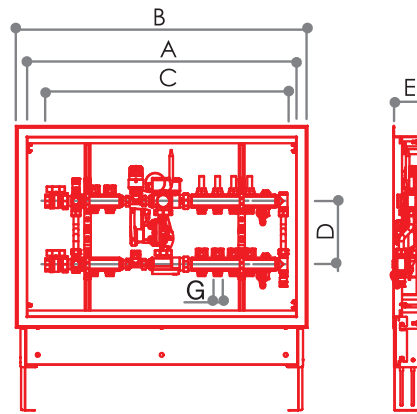

CCBAP 4033

Impianto con distribuzione bassa
+ 3 attacchi di alta (G 3/4 EK).

ARTICOLO	CODICE	MISURA	N. ATTACCHI PANNELLI	A	B	C	D	E	F	G		
CCBAP4033/2	17403302N	G 1" x G 3/4 EK	2	850	910	720	200	90	-		25,218	1
CCBAP4033/3	17403303N		3	850	910	770			-		25,812	1
CCBAP4033/4	17403304N		4	1000	1060	820			-		28,406	1
CCBAP4033/5	17403305N		5	1000	1060	870			-		29,000	1
CCBAP4033/6	17403306N		6	1000	1060	920			-		29,594	1
CCBAP4033/7	17403307N		7	1200	1260	970			-		32,188	1
CCBAP4033/8	17403308N		8	1200	1260	1020			-		32,782	1
CCBAP4033/9	17403309N		9	1200	1260	1070			-		33,376	1
CCBAP4033/10	17403310N		10	1200	1260	1120			-		33,970	1
CCBAP4033/11	17403311N		11	1300	1360	1170			-		36,564	1
CCBAP4033/12	17403312N		12	1300	1360	1220			-		37,158	1

DIAGRAMMA DI PORTATA

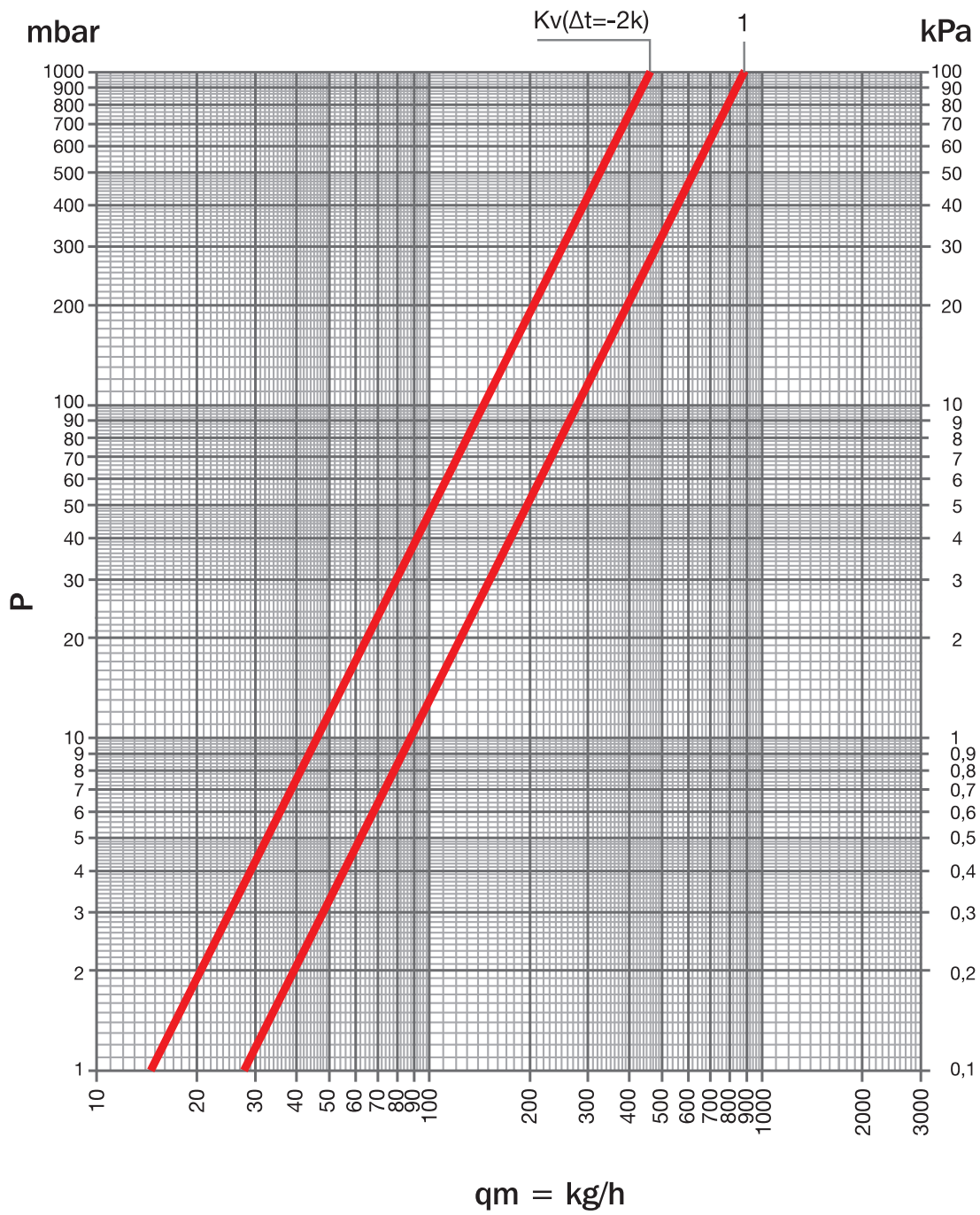

Kv	Kv Δt 2 °C	POS
0.88	0.46	1

SISTEMI DI REGOLAZIONE PER IMPIANTI A PANNELLI RADIANTI CON IL GRUPPO POMPA GP 1190 E KIT PER ALTA TEMPERATURA FM 750



20 kW

CARATTERISTICHE TECNICHE

- Pressione massima di esercizio 6 bar
- Pressione massima differenziale 1 bar
- Temperatura massima di esercizio sul primario 80 °C
- Temperatura massima di esercizio sul secondario 70 °C
- Intervallo di temperatura sul secondario 20 °C ÷ 65 °C
- Potenza termica massima 20 kW con un Δt di 10 °C e temperatura del primario ≥ 70 °C

CARATTERISTICHE COSTRUTTIVE

Le parti stampate sono in ottone a basso contenuto di piombo in conformità con le normative CW617N UNI EN 12165:2016. Tutte le guarnizioni o-ring sono in EPDM perossidico. Le parti in acciaio inox sono in AISI 316. Tutti i componenti sono dotati di tenuta morbida o-ring, non necessitano di alcun elemento intermedio di sigillatura (es. PTFE, canapa, ecc).

IMPIEGO

Il kit per alta temperatura FM 750 associato ai gruppi pompa GP 1190, permette di installare in un'unica cassetta sia la distribuzione di acqua calda per un impianto tradizionale a radiatori, sia la distribuzione di acqua per un impianto a pannelli radianti.

COMPONENTI

- 1 Testa termostatica con sensore a distanza
- 2 Valvola miscelatrice termostattizzabile con terza via in bypass
- 3 Raccordi da G 3/4 con tenuta morbida
- 4 Raccordi da G 1" con tenuta morbida
- 5 Raccordo femmina con guarnizione piana
- 6 Tubo rame per bypass
- 7 Raccordo a compressione
- 8 Valvola di bilanciamento

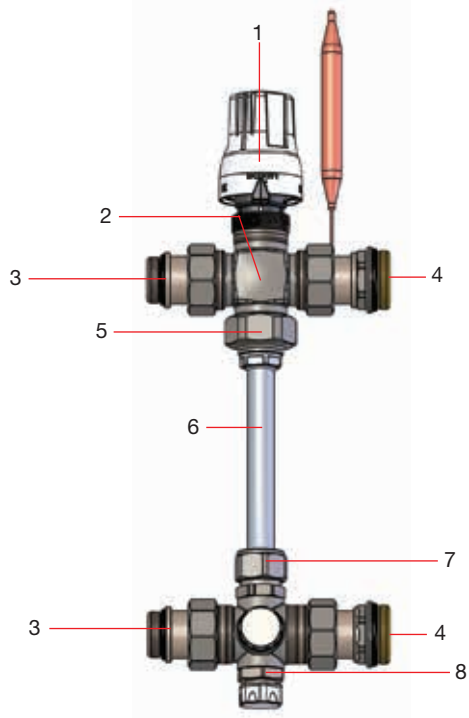

SCHEMA IDRAULICO

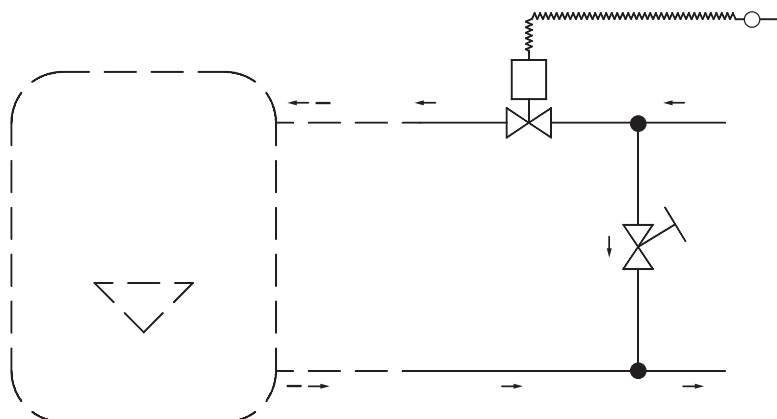

FUNZIONAMENTO

Il sistema FM 750 mantiene costante, a un valore impostato, la temperatura dell'acqua nei pannelli radianti, miscelando l'acqua ad alta temperatura in arrivo dalla caldaia con quella in ricircolo attraverso il circuito di bypass.

Una valvola termostatica con sonda a distanza rileva la temperatura e, in base al valore rilevato, integra il circuito di una quantità di acqua tale da compensare la potenza termica ceduta dai pannelli radianti.

Il miscelatore termostatico "Flow Mix" consiste in una valvola di miscelazione termostatica utilizzata in combinazione con una valvola di bilanciamento. Essa regola, mediante un dentatore, la quantità di acqua che ritorna dal circuito a pannelli radianti da mandare all'attacco a bassa temperatura del miscelatore.

Si consiglia l'utilizzo di un termostato di sicurezza da installare sulla valvola in ingresso alla pompa al fine di evitare danni dovuti a un improvviso innalzamento della temperatura.

L'intervento del termostato deve bloccare il funzionamento della pompa.

Questo tipo di impianto riesce a fornire una potenza termica massima di 20 kW con un Δt di 10 °C e una temperatura del primario ≥ 70 °C.

Il sistema "Flow Mix" può essere installato sia a sinistra sia a destra del gruppo pompa GP 1190.

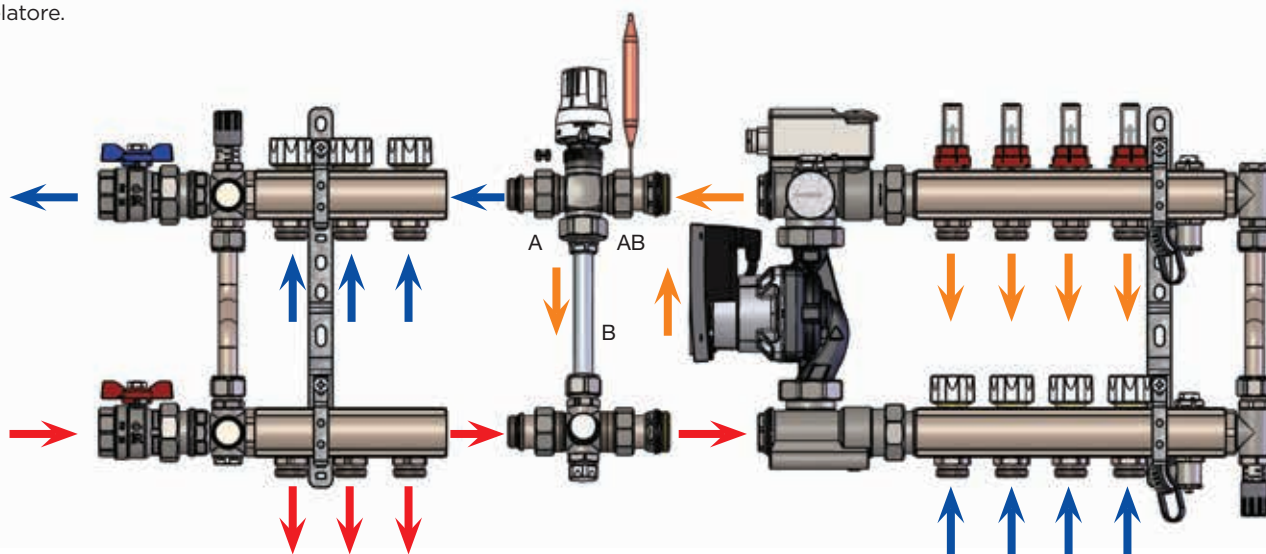

NEL PRIMO CASO

- La via della valvola miscelatrice AB deve essere collegata alla parte finale del gruppo pompa;
- La via A deve essere collegata ai collettori di ritorno della zona di alta;

- La via B è il bypass;
- La sonda della testa termostatica deve essere inserita nell'apposita sede nella parte superiore del gruppo pompa prima d'installare il **Flow Mix**.

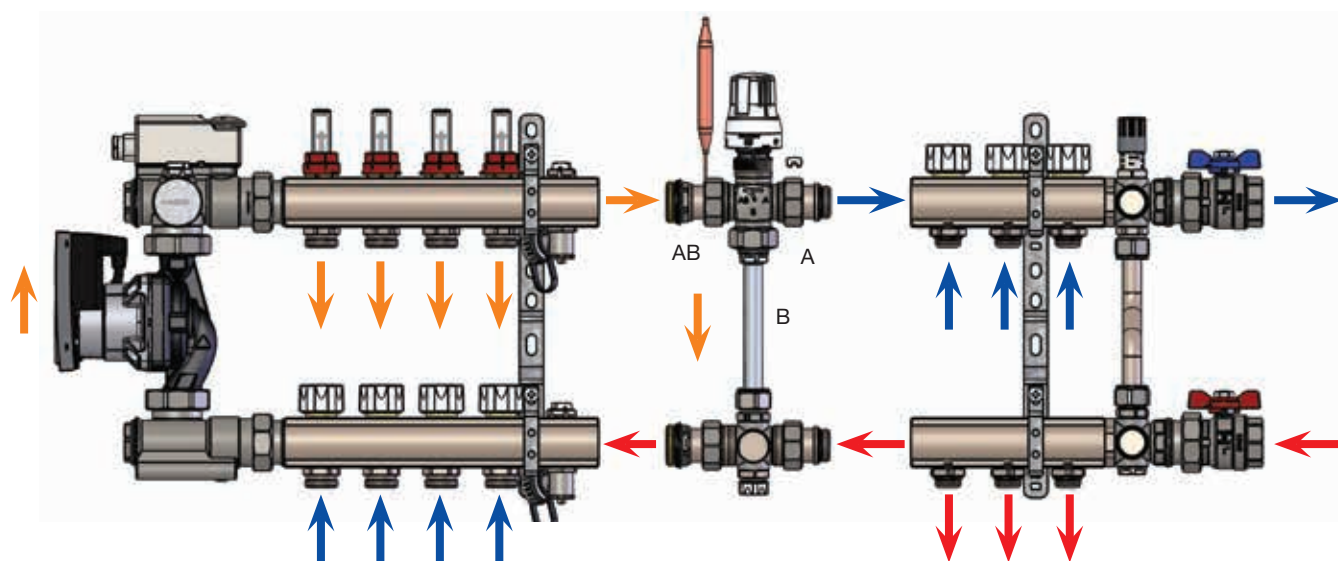

NEL SECONDO CASO

- La via della valvola miscelatrice AB deve essere collegata alla parte finale del collettore di mandata della zona di bassa;
- La via A deve essere collegata ai collettori di ritorno della zona di alta;

- La via B è il bypass;
- La sonda della testa termostatica deve essere inserita nell'apposita sede nella parte superiore del gruppo pompa.

DISEGNO DIMENSIONALE

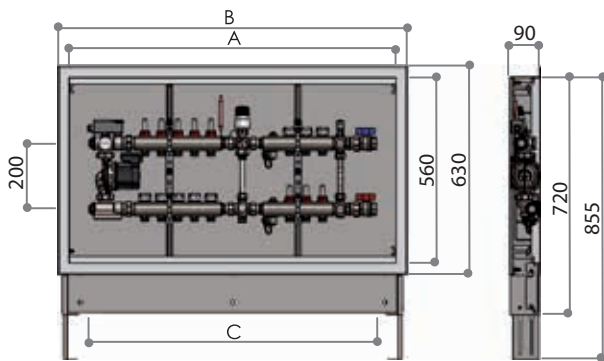
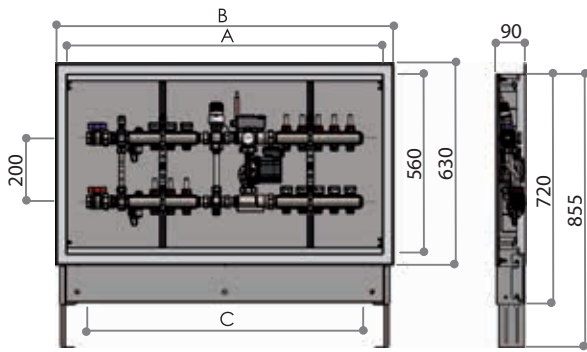

N. ATTACCHI PANNELLI	A	B	C
CON 2 STACCHI DI ALTA			
2	910	850	670
3	910	850	720
4	910	850	770
5	1060	1000	820
6	1060	1000	870
7	1060	1000	920
8	1260	1200	970
9	1260	1200	1020
10	1260	1200	1070
11	1260	1200	1120
12	1360	1300	1170
CON 3 STACCHI DI ALTA			
2	910	850	720
3	910	850	770
4	1060	1000	820
5	1060	1000	870
6	1060	1000	920
7	1260	1200	970
8	1260	1200	1020
9	1260	1200	1070
10	1260	1200	1120
11	1360	1300	1170
12	1360	1300	1220

N. ATTACCHI PANNELLI	A	B	C
CON 2 STACCHI DI ALTA			
2	910	850	670
3	910	850	720
4	910	850	770
5	1060	1000	820
6	1060	1000	870
7	1060	1000	920
8	1260	1200	970
9	1260	1200	1020
10	1260	1200	1070
11	1260	1200	1120
12	1360	1300	1170
CON 3 STACCHI DI ALTA			
2	910	850	720
3	910	850	770
4	1060	1000	820
5	1060	1000	870
6	1060	1000	920
7	1260	1200	970
8	1260	1200	1020
9	1260	1200	1070
10	1260	1200	1120
11	1360	1300	1170
12	1360	1300	1220

SISTEMI DI REGOLAZIONE PER IMPIANTI A PANNELLI RADIANTI CON IL GRUPPO POMPA GP 1190 E KIT PER ALTA TEMPERATURA

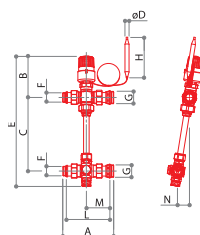

FM 750

Kit flow mix con bypass per il sistema di riscaldamento misto.

CODICE	MISURA	A	B	C	D	E	F	G	H	L	M	N			
68763602	G 1"	138	115	200	11	365	G 3/4	G 1"	110	118	64	32	1442	1	8

DIAGRAMMA DI PORTATA

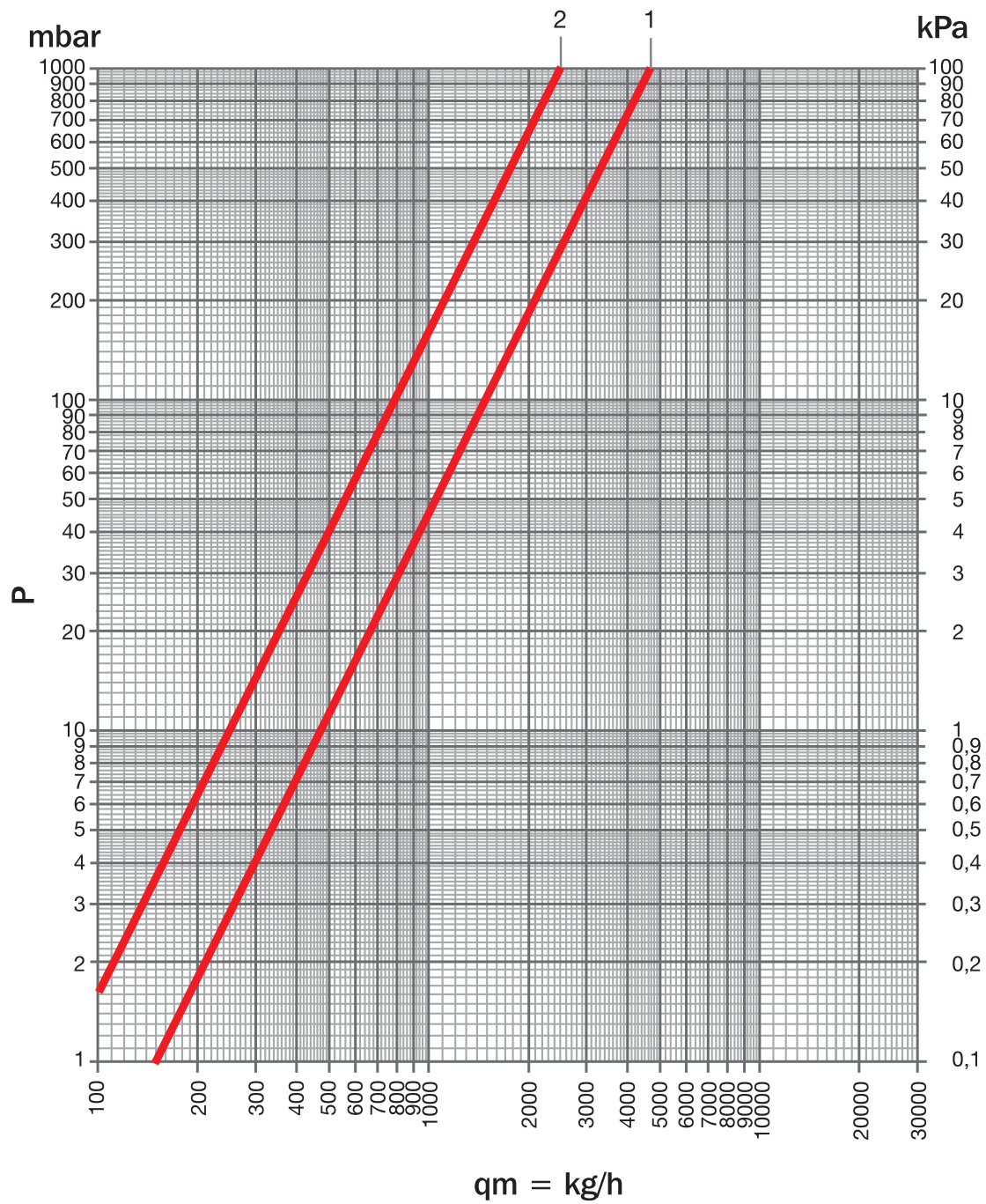

Kv	Kv Δt 2 °C		POS
4.70	0.36	via A - AB	1
2.50	-	via B - AB sempre aperta	2

SISTEMI DI REGOLAZIONE PER IMPIANTI A PANNELLI RADIANTI CON IL GRUPPO DI MISCELA GM 1192



20 kW

CARATTERISTICHE TECNICHE

Pressione massima di esercizio 6 bar
 Pressione massima differenziale 1 bar
 Campo di regolazione sul bypass 0.2 ÷ 0.7 bar
 Temperatura massima di esercizio sul primario 80 °C
 Temperatura massima di esercizio sul secondario 70 °C
 Intervallo di temperatura sul secondario 20 °C ÷ 65 °C
 Potenza termica massima 20 kW con un Δt di 10 °C
 e temperatura del primario ≥ 70 °C

CARATTERISTICHE COSTRUTTIVE

Le parti stampate sono in ottone a basso contenuto di piombo in conformità con le normative CW617N UNI EN 12165:2016. Tutte le guarnizioni o-ring sono in EPDM perossidico. Le parti in acciaio inox sono in AISI 316.

Tutti i componenti sono dotati di tenuta morbida o-ring, non necessitano di alcun elemento intermedio di sigillatura (es. PTFE, canapa, ecc).

Attacchi laterali da W24x19 o da G 3/4 EK con interassi da 50 mm. Il gruppo di miscela GM 1192 ha un passaggio interno pari a un \varnothing 23 mm.

IMPIEGO

Il gruppo di miscela GM 1192 è un gruppo di regolazione che riunisce in un unico dispositivo un insieme di componenti in grado di mantenere la temperatura in un circuito a pannelli radianti ad un valore impostato all'interno di un impianto di riscaldamento di tipo misto. La temperatura dell'acqua nei pannelli radianti viene mantenuta costante da una valvola di regolazione, la quale miscela l'acqua ad alta temperatura in arrivo dalla caldaia con quella a più bassa temperatura in circolazione nei pannelli stessi.

Il GM 1192 può essere collegato direttamente, mediante un raccordo a tenuta morbida da G 1" maschio, ai collettori per pannelli radianti di produzione Luxor già in commercio. Perciò è molto vantaggioso perché si può tenere il gruppo di miscela come componente modulare.

Inoltre un impianto di riscaldamento di tipo misto che impiega il GM 1192 diviene estremamente flessibile perché si ha la possibilità di adeguare il gruppo di miscela a successive esigenze del circuito secondario. Quindi si può espandere l'impianto a pannelli radianti aggiungendo delle uscite senza problemi di temperatura o di pressione a valle del gruppo.

Il GM 1192 può essere tarato sia per aumentare la potenza di riscaldamento che per compensare le perdite di carico.

Infine il GM 1192, in virtù della sua ampia capacità di regolazione, permette di rendere indipendente il circuito secondario da quello primario nel caso in cui vengano sostituiti componenti importanti dell'impianto, ad esempio nel caso della sostituzione di una caldaia con un'altra con differente principio di funzionamento.

Mediante l'impiego del circuito di bypass, la pompa di circolazione può continuare a funzionare alle condizioni di progetto impostate.

Questo tipo di impianto riesce a fornire una potenza termica massima 20 kW con un Δt di 10 °C e temperatura del primario ≥ 70 °C.

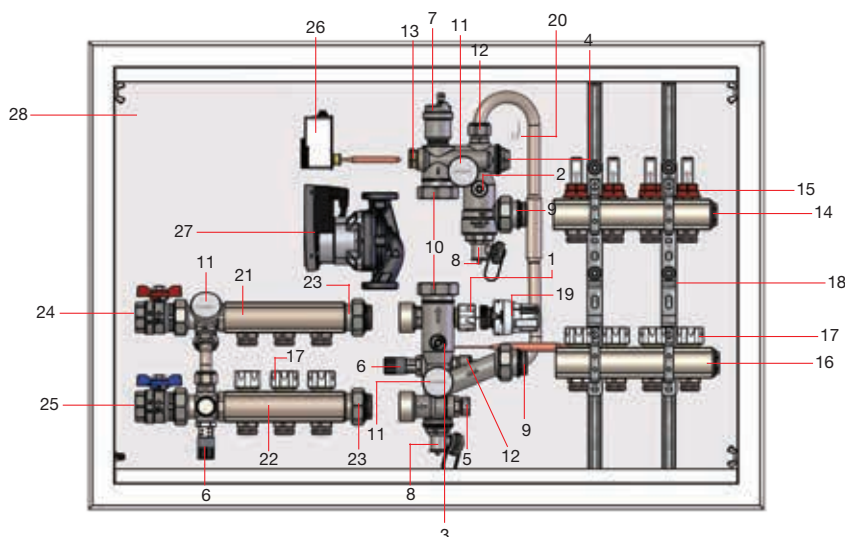

COMPONENTI

- 1 Valvola di regolazione.
La valvola di regolazione dispone di un vitone con funzionamento a pistone. Su questo vitone possono essere installati la testa termostatica per i punti fissi oppure una testa elettrotermica 0-10 Volt.
- 2 Valvola a sfera per intercettazione pompa.
Permette l'intercettazione in caso di manutenzione e sostituzione della pompa di circolazione senza vuotare l'impianto.
- 3 Valvola a sfera per intercettazione pompa e bilanciamento del circuito secondario.
È la valvola che permette di intercettare la pompa e di bilanciare le perdite di carico nel circuito secondario a pannelli radianti con le perdite di carico del circuito primario causate dalla valvola di regolazione "1". Il gruppo di regolazione GM 1192 viene fornito con la valvola di bilanciamento tarata sul valore di $K_v = 7$, poiché questo è il valore in grado di soddisfare le applicazioni fino a 11 Kw/h, qualora fossero necessarie potenze superiori, la valvola deve essere settata ad un K_v inferiore.
- 4 Pozzetto per alloggiamento della sonda.
- 5 Valvola di intercettazione del circuito a bassa temperatura.
Questa valvola viene impostata solo all'inizio della messa in esercizio per regolare la perdita di carico dell'acqua in uscita dal circuito secondario. Il detentore deve essere tutto chiuso nel caso in cui si voglia separare completamente il circuito secondario da quello primario per fare della manutenzione sul primario. Inoltre all'interno della sede è installata una valvola di non ritorno che impedisce all'acqua del primario di riscaldare il gruppo di miscela quando la pompa è spenta e la testa termostatica è chiusa. Normalmente questa valvola deve essere sempre tutta aperta.
- 6 Valvola di bypass differenziale.
L'impiego della valvola di bypass è necessario in tutti gli impianti di riscaldamento ad acqua calda dove sono presenti valvole di zona a 2 vie o corpi scaldanti muniti di valvole di regolazione che consentono in determinate condizioni, la completa esclusione del circuito. La valvola garantisce un ricircolo tale da impedire che la pompa sia utilizzata in condizioni lontane da quelle di progetto evitando sbilanciamenti dei circuiti funzionanti in parallelo e fastidiosi rumori dovuti all'aumento della velocità del fluido nell'attraversamento degli organi di regolazione.
- 7 Valvola automatica di sfogo aria (attacchi da 1/2).
Interviene durante la fase di caricamento dell'impianto sfogando l'aria presente nel gruppo.
- 8 Rubinetti di carico-scarico con attacco orientabile da 3/4 e tappo di sicurezza.
- 9 Raccordi di unione 3 pezzi a tenuta morbida CR 498 da G 1".
- 10 Raccordi da G 1 1/2 per il collegamento della pompa di circolazione.
- 11 Termometri di rilevazione della temperatura con scala da 0° a 80° C.
Permettono il controllo della temperatura dell'acqua sui collettori di mandata e ritorno dei pannelli radianti del circuito secondario.
- 12 Raccordi di unione per tubo di bypass.
- 13 Pozzetto per alloggiamento del termostato di sicurezza.
- 14 Collettore di mandata ai pannelli radianti.
- 15 Regolatori e misuratori di portata, con capacità da 0,5 l/min a 5 l/min.
In caso lo sporco impedisse la lettura della portata, è possibile smontare e pulire il bicchiere con l'impianto in funzione.
- 16 Collettore di ritorno dei pannelli radianti.
- 17 Valvole predisposte per la regolazione elettrotermica con cappucci di protezione.
- 18 Staffe.
- 19 Testa termostatica con sensore a distanza.
- 20 Molla per il fissaggio della sonda a distanza della testa termostatica.
- 21 Collettore di mandata per il primario.
- 22 Collettore di ritorno del primario.
- 23 Raccordi di unione 3 pezzi a tenuta morbida da G 1".
- 24 Valvola a sfera di mandata dalla caldaia.
- 25 Valvola a sfera di ritorno alla caldaia.
- 26 Termostato di sicurezza ad immersione.
- 27 Pompa di circolazione con motore sincrono 25/60 interasse 130 mm in classe energetica A.
- 28 Cassetta con piedi regolabili, cornice e porta bianchi RAL 9016.

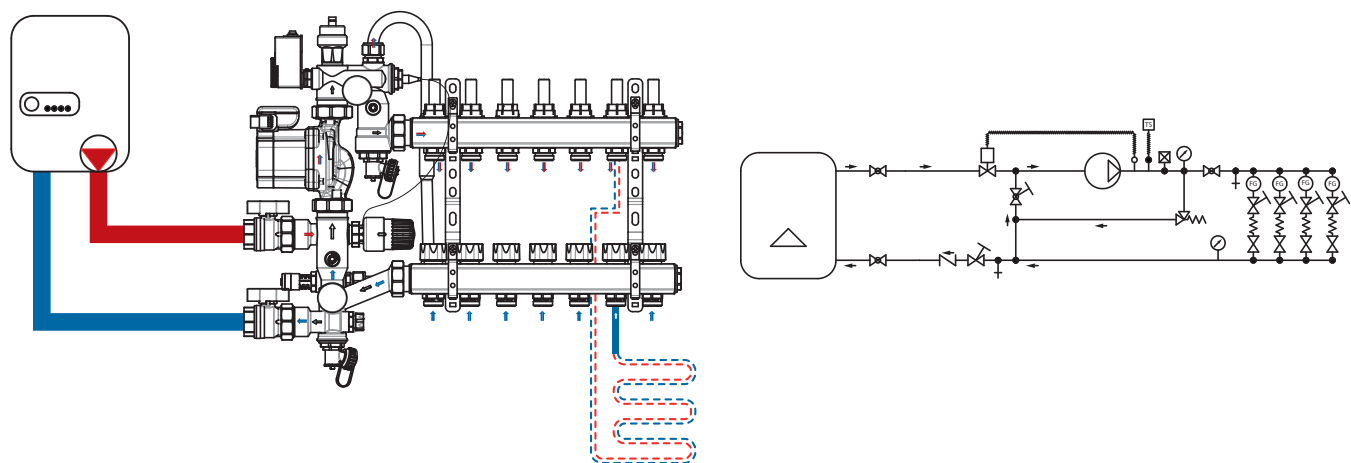

LEGENDA SCHEMI IDRAULICI

	valvola intercettazione		rubinetto di carico o scarico acqua		pompa circolazione
	valvola sfera		termometro		utilizzatore: pannelli radianti, termoarredi ecc.
	valvola non ritorno, la freccia indica il senso di flusso		dispositivo di sfogo aria manuale		filtro
	valvola di sicurezza (valvola di bypass)		dispositivo di sfogo aria automatico		valvola a 3 vie
	valvola intercettazione, regolazione e bilanciamento		misuratore di portata		
	valvola a sfera d'intercettazione, regolazione e bilanciamento		termostato di sicurezza ad immersione		
	valvola di iniezione con sensore a distanza		termostato di sicurezza a contatto		

FUNZIONAMENTO

Il sistema per il riscaldamento a punto fisso mantiene costante a un valore impostato la temperatura dell'acqua nei pannelli radianti, miscelando l'acqua ad alta temperatura in arrivo dalla caldaia con quella in circolazione nei pannelli stessi.

Una valvola termostatica con sonda a distanza rileva la temperatura e, in base al valore rilevato, integra il circuito di una quantità di acqua ad alta temperatura, tale da compensare la potenza termica ceduta dai pannelli radianti.

Si consiglia comunque di montare sulla valvola in ingresso alla pompa un termostato di sicurezza, al fine di evitare danni dovuti a un innalzamento imprevisto della temperatura.

L'intervento del termostato di sicurezza deve bloccare il funzionamento della pompa.

Il sistema può essere integrato con una valvola di bypass che, in presenza di una eccessiva pressione differenziale, scarichi la prevalenza in esubero salvaguardando i componenti dell'impianto e, nel caso siano utilizzate teste termoelettriche per l'intercettazione dei circuiti, eviti fenomeni di rumore e usura della pompa di circolazione.



Questo tipo di impianto riesce a fornire una potenza termica massima di 20 kW con un Δt di 10°C e una temperatura del primario ≥ 70 °C.

SISTEMI DI REGOLAZIONE PER IMPIANTI A PANNELLI RADIANTI CON IL GRUPPO DI MISCELA GM 1192



GM 1192



Gruppo di regolazione a punto fisso per impianti di riscaldamento a pavimento con attacco per pompa con testa termostatica.

CODICE	MISURA			
72000050	CD G 1" x 130 mm	4580	-	1
72000050X	CX G 1" X 130 mm	4744	-	1
72000055	CD G 1" x 180 mm	4610	-	1



GM 1193

Gruppo di regolazione per impianti di riscaldamento a pavimento con attacco per pompa.

CODICE	MISURA			
72000052	G 1" x 130 mm	4434	-	1
72000057	G 1" x 180 mm	4464	-	1



CB 1200



Coibentatura per gruppo di regolazione art. GM 1192 con attacco pompa da 130 mm.

CODICE	MISURA			
72000060	-	192	2	-



CB 1205

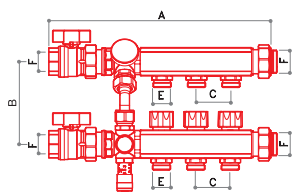
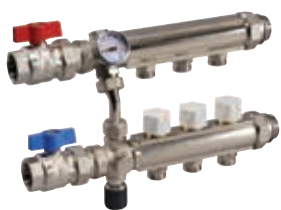

Coibentatura per collettori serie CD e CX per 12 attacchi.

CODICE	MISURA			
72000064	CD G 1"	156	-	6
72000066	CX G 1"	149	-	6
72000065	CD G 1"1/4	180	-	6



CD 4071

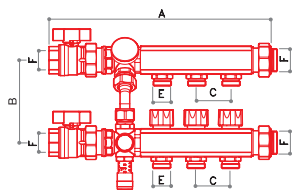

Kit di alta per gruppo di miscela art. GM1192.

CODICE	ARTICOLO	MISURA	A	B	C	D	E	F	G	H			
17407102N	CD4071/2	G 1" x (W24x19)	275	120	25	-	W24x19	G 1"	-	-	3490	1	-
17407103N	CD4071/3		325	120	25	-	W24x19	G 1"	-	-	4050	1	-
17407104N	CD4071/4		375	120	25	-	W24x19	G 1"	-	-	4610	1	-



CD 4072

Kit di alta per gruppo di miscela art. GM 1192.

CODICE	ARTICOLO	MISURA	A	B	C	D	E	F	G	H			
17407202N	CD4072/2	G 1" x G 3/4 EK	275	120	25	-	G 3/4 EK	G 1"	-	-	3534	1	-
17407203N	CD4072/3		325	120	25	-	G 3/4 EK	G 1"	-	-	4116	1	-
17407204N	CD4072/4		375	120	25	-	G 3/4 EK	G 1"	-	-	4698	1	-

GRUPPI PREMONTATI



Profondità
90 mm

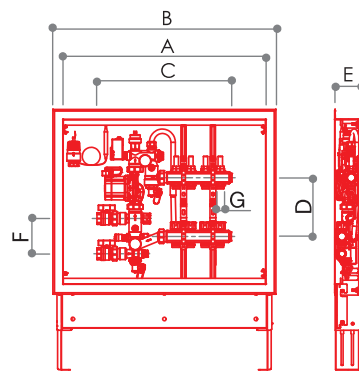

CCBP 4026

Impianto con distribuzione a punto fisso bassa (W24x19).

ARTICOLO	CODICE	MISURA	N. ATTACCHI PANNELLI	A	B	C	D	E	F	G	H	L	kg	📦
CCBP4026/2	17402602N	G 1" x (W24x19)	2	500	560	360	200	90	120	W24x19	-	-	19,218	1
CCBP4026/3	17402603N		3	700	760	410					-	-	21,812	1
CCBP4026/4	17402604N		4	700	760	460					-	-	22,406	1
CCBP4026/5	17402605N		5	700	760	510					-	-	23,00	1
CCBP4026/6	17402606N		6	700	760	560					-	-	23,594	1
CCBP4026/7	17402607N		7	850	910	610					-	-	26,188	1
CCBP4026/8	17402608N		8	850	910	660					-	-	26,782	1
CCBP4026/9	17402609N		9	850	910	710					-	-	27,376	1
CCBP4026/10	17402610N		10	1000	1060	760					-	-	29,970	1
CCBP4026/11	17402611N		11	1000	1060	810					-	-	30,564	1
CCBP4026/12	17402612N		12	1000	1060	860					-	-	31,158	1
CCBP4026/13	17402613N		13	1200	1260	910					-	-	33,758	1



Profondità
90 mm

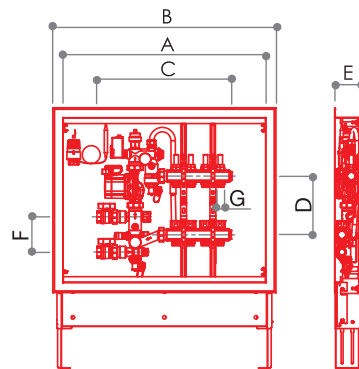

CCBP 4036

Impianto con distribuzione a punto fisso bassa G 3/4 EK.

ARTICOLO	CODICE	MISURA	N. ATTACCHI PANNELLI	A	B	C	D	E	F	G	H	L	kg	📦
CCBP4036/2	17403602N	G 1" x G 3/4 EK	2	500	560	360	200	90	120	G 3/4 EK	-	-	19,218	1
CCBP4036/3	17403603N		3	700	760	410					-	-	21,812	1
CCBP4036/4	17403604N		4	700	760	460					-	-	22,406	1
CCBP4036/5	17403605N		5	700	760	510					-	-	23,000	1
CCBP4036/6	17403606N		6	700	760	560					-	-	23,594	1
CCBP4036/7	17403607N		7	850	910	610					-	-	26,188	1
CCBP4036/8	17403608N		8	850	910	660					-	-	26,782	1
CCBP4036/9	17403609N		9	850	910	710					-	-	27,376	1
CCBP4036/10	17403610N		10	1000	1060	760					-	-	29,970	1
CCBP4036/11	17403611N		11	1000	1060	810					-	-	30,564	1
CCBP4036/12	17403612N		12	1000	1060	860					-	-	31,158	1
CCBP4036/13	17403613N		13	1200	1260	910					-	-	33,758	1



Profondità
90 mm

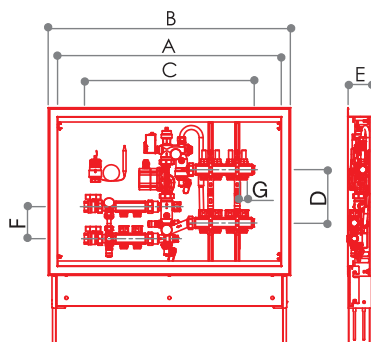

CCBAP 4025

Impianto con distribuzione bassa
+ 2 attacchi di alta (W24x19).

ARTICOLO	CODICE	MISURA	N. ATTACCHI PANNELLI	A	B	C	D	E	F	G	H	L		
CCBAP4025/2	17402502N	G 1" x (W24x19)	2	700	760	540	200	90	120	W24x19	-	-	23,648	1
CCBAP4025/3	17402503N		3	700	760	590					-	-	24,242	1
CCBAP4025/4	17402504N		4	850	910	640					-	-	26,836	1
CCBAP4025/5	17402505N		5	850	910	690					-	-	27,430	1
CCBAP4025/6	17402506N		6	850	910	740					-	-	28,024	1
CCBAP4025/7	17402507N		7	1000	1060	790					-	-	30,618	1
CCBAP4025/8	17402508N		8	1000	1060	840					-	-	31,212	1
CCBAP4025/9	17402509N		9	1000	1060	890					-	-	31,806	1
CCBAP4025/10	17402510N		10	1200	1260	940					-	-	34,400	1
CCBAP4025/11	17402511N		11	1200	1260	990					-	-	34,994	1
CCBAP4025/12	17402512N		12	1200	1260	1040					-	-	35,588	1
CCBAP4025/13	17402513N		13	1200	1260	1090					-	-	36,182	1



Profondità
90 mm

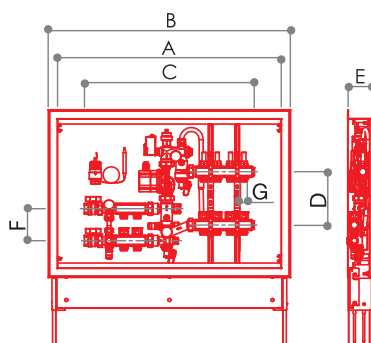

CCBAP 4027

Impianto con distribuzione bassa
+ 3 attacchi di alta (W24x19).

ARTICOLO	CODICE	MISURA	N. ATTACCHI PANNELLI	A	B	C	D	E	F	G	H	L		
CCBAP4027/2	17402702N	G 1" x (W24x19)	2	700	760	590	200	90	120	W24x19	-	-	24,218	1
CCBAP4027/3	17402703N		3	850	910	640					-	-	26,812	1
CCBAP4027/4	17402704N		4	850	910	690					-	-	27,406	1
CCBAP4027/5	17402705N		5	850	910	740					-	-	28,000	1
CCBAP4027/6	17402706N		6	1000	1060	790					-	-	30,594	1
CCBAP4027/7	17402707N		7	1000	1060	840					-	-	31,188	1
CCBAP4027/8	17402708N		8	1000	1060	890					-	-	31,782	1
CCBAP4027/9	17402709N		9	1200	1260	940					-	-	34,376	1
CCBAP4027/10	17402710N		10	1200	1260	990					-	-	34,970	1
CCBAP4027/11	17402711N		11	1200	1260	1040					-	-	35,564	1
CCBAP4027/12	17402712N		12	1200	1260	1090					-	-	36,158	1
CCBAP4027/13	17402713N		13	1300	1360	1140					-	-	38,752	1

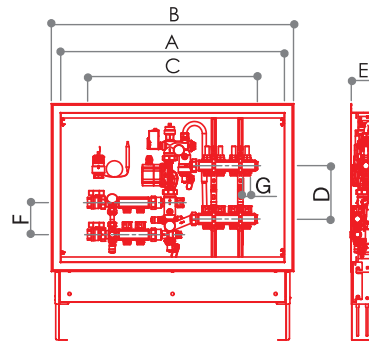

CCBAP 4079

Impianto con distribuzione bassa + 4 attacchi di alta (W24x19).

ARTICOLO	CODICE	MISURA	N. ATTACCHI PANNELLI	A	B	C	D	E	F	G	H	L	kg	📦
CCBAP4079/2	17407902N	G 1" x (W24x19)	2	850	910	640	200	90	120	W24x19	-	-	24,788	1
CCBAP4079/3	17407903N		3	850	910	690					-	-	27,382	1
CCBAP4079/4	17407904N		4	850	910	740					-	-	27,976	1
CCBAP4079/5	17407905N		5	1000	1060	790					-	-	28,570	1
CCBAP4079/6	17407906N		6	1000	1060	840					-	-	31,164	1
CCBAP4079/7	17407907N		7	1000	1060	890					-	-	31,758	1
CCBAP4079/8	17407908N		8	1200	1260	940					-	-	32,352	1
CCBAP4079/9	17407909N		9	1200	1260	990					-	-	34,946	1
CCBAP4079/10	17407910N		10	1200	1260	1040					-	-	35,540	1
CCBAP4079/11	17407911N		11	1200	1260	1090					-	-	36,134	1
CCBAP4079/12	17407912N		12	1300	1360	1140					-	-	36,728	1
CCBAP4079/13	17407913N		13	1300	1360	1190					-	-	39,322	1

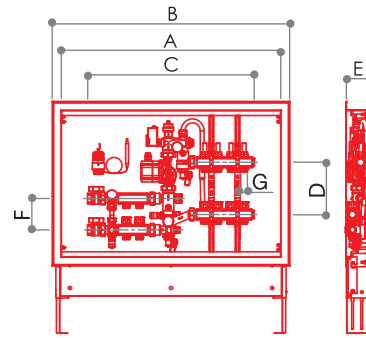

CCBAP 4035

Impianto con distribuzione bassa + 2 attacchi di alta G 3/4 EK.

ARTICOLO	CODICE	MISURA	N. ATTACCHI PANNELLI	A	B	C	D	E	F	G	H	L	kg	📦
CCBAP4035/2	17403502N	G 1" x G 3/4 EK	2	700	760	540	200	90	120	G 3/4 EK	-	-	23,648	1
CCBAP4035/3	17403503N		3	700	760	590					-	-	24,242	1
CCBAP4035/4	17403504N		4	850	910	640					-	-	26,836	1
CCBAP4035/5	17403505N		5	850	910	690					-	-	27,430	1
CCBAP4035/6	17403506N		6	850	910	740					-	-	28,024	1
CCBAP4035/7	17403507N		7	1000	1060	790					-	-	30,618	1
CCBAP4035/8	17403508N		8	1000	1060	840					-	-	31,212	1
CCBAP4035/9	17403509N		9	1000	1060	890					-	-	31,806	1
CCBAP4035/10	17403510N		10	1200	1260	940					-	-	34,400	1
CCBAP4035/11	17403511N		11	1200	1260	990					-	-	34,994	1
CCBAP4035/12	17403512N		12	1200	1260	1040					-	-	35,588	1
CCBAP4035/13	17403513N		13	1200	1260	1090					-	-	36,182	1



Profondità
90 mm

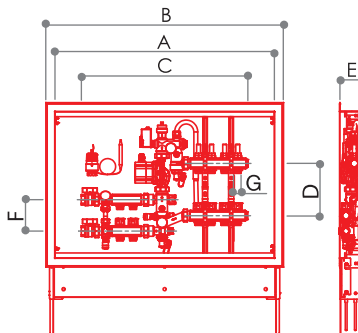

CCBAP 4037

Impianto con distribuzione bassa
+ 3 attacchi di alta G 3/4 EK.

ARTICOLO	CODICE	MISURA	N. ATTACCHI PANNELLI	A	B	C	D	E	F	G	H	L		
CCBAP4037/2	17403702N	G 1" x G 3/4 EK	2	700	760	590	200	90	120	G 3/4 EK	-	-	24,218	1
CCBAP4037/3	17403703N		3	850	910	640					-	-	26,812	1
CCBAP4037/4	17403704N		4	850	910	690					-	-	27,406	1
CCBAP4037/5	17403705N		5	850	910	740					-	-	28,000	1
CCBAP4037/6	17403706N		6	1000	1060	790					-	-	30,594	1
CCBAP4037/7	17403707N		7	1000	1060	840					-	-	31,188	1
CCBAP4037/8	17403708N		8	1000	1060	890					-	-	31,782	1
CCBAP4037/9	17403709N		9	1200	1260	940					-	-	34,376	1
CCBAP4037/10	17403710N		10	1200	1260	990					-	-	34,970	1
CCBAP4037/11	17403711N		11	1200	1260	1040					-	-	35,564	1
CCBAP4037/12	17403712N		12	1200	1260	1090					-	-	36,158	1
CCBAP4037/13	17403713N		13	1300	1360	1140					-	-	38,752	1



Profondità
90 mm

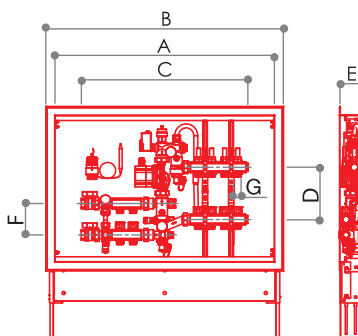

CCBAP 4080

Impianto con distribuzione bassa
+ 4 attacchi di alta G 3/4 EK.

ARTICOLO	CODICE	MISURA	N. ATTACCHI PANNELLI	A	B	C	D	E	F	G	H	L		
CCBAP4080/2	17408002N	G 1" x G 3/4 EK	2	850	910	640	200	90	120	G 3/4 EK	-	-	24,788	1
CCBAP4080/3	17408003N		3	850	910	690					-	-	27,382	1
CCBAP4080/4	17408004N		4	850	910	740					-	-	27,976	1
CCBAP4080/5	17408005N		5	1000	1060	790					-	-	28,570	1
CCBAP4080/6	17408006N		6	1000	1060	840					-	-	31,164	1
CCBAP4080/7	17408007N		7	1000	1060	890					-	-	31,758	1
CCBAP4080/8	17408008N		8	1200	1260	940					-	-	32,352	1
CCBAP4080/9	17408009N		9	1200	1260	990					-	-	34,946	1
CCBAP4080/10	17408010N		10	1200	1260	1040					-	-	35,540	1
CCBAP4080/11	17408011N		11	1200	1260	1090					-	-	36,134	1
CCBAP4080/12	17408012N		12	1300	1360	1140					-	-	36,728	1
CCBAP4080/13	17408013N		13	1300	1360	1190					-	-	39,322	1

GRUPPI POMPA PER SOLARE



CARATTERISTICHE COSTRUTTIVE

Le parti stampate sono in ottone a basso contenuto di piombo in conformità con le normative CW617N UNI EN 12165:2016. Tutte le guarnizioni o-ring sono in EPDM perossidico. Le guarnizioni sono in PTFE G415 caricato a carbografite.

I gusci di isolamento per la coibentatura sono in PPE nero (40 kg/m³).

Tutti i componenti sono dotati di tenuta morbida o-ring, non necessitano di alcun elemento intermedio di sigillatura (es. canapa, ecc.).

CARATTERISTICHE TECNICHE

Temperatura massima di esercizio in continuo 130 °C
 Range limitatore di flusso 0.5 ÷ 15 l/min
 Range termometri 0 ÷ 160 °C
 Pressione taratura valvola di sicurezza 6 bar
 Range manometro 0 ÷ 16 bar
 Fluido di lavoro acqua con glicole (max 50%).

CARATTERISTICHE TECNICHE CIRCOLATORE

Modello Grundfos Solar 15-65 130
 Conessioni da 1" M a tenuta piana
 Interasse 130 mm
 Classe di temperatura TF 110
 Temperatura massima di picco 140 °C
 Pressione massima di esercizio 10 bar

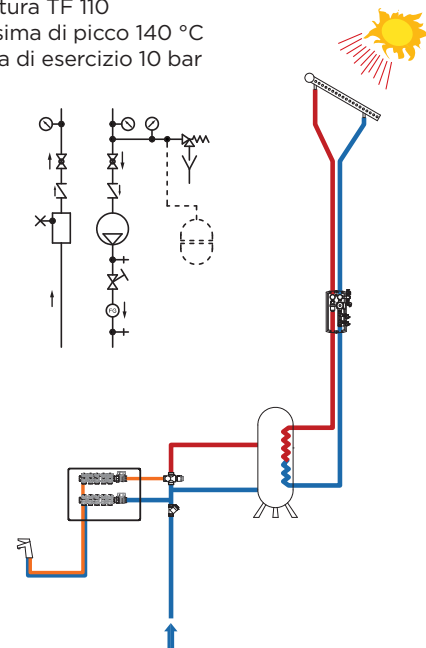

LEGENDA SCHEMI IDRAULICI

	valvola intercettazione		rubinetto di carico o scarico acqua		pompa circolazione
	valvola sfera		termometro		utilizzatore: pannelli radianti, termoarredi ecc.
	valvola non ritorno, la freccia indica il senso di flusso		dispositivo di sfogo aria manuale		filtro
	valvola di sicurezza (valvola di bypass)		dispositivo di sfogo aria automatico		valvola a 3 vie
	valvola intercettazione, regolazione e bilanciamento		misuratore di portata		
	valvola a sfera d'intercettazione, regolazione e bilanciamento		termostato di sicurezza ad immersione		
	valvola di iniezione con sensore a distanza		termostato di sicurezza a contatto		

FUNZIONAMENTO

I sistemi gruppo pompa solare hanno lo scopo di utilizzare l'energia termica solare e trasferirla a un fluido termovettore, che a sua volta la cede all'acqua necessaria all'utenza.

I gruppi sono dotati di una pompa che fa circolare il fluido termovettore all'interno dell'impianto, e tutti i componenti di cui è costituito sono costruiti con materiali e caratteristiche

adatte a sopportare le elevate temperature che il fluido può raggiungere.

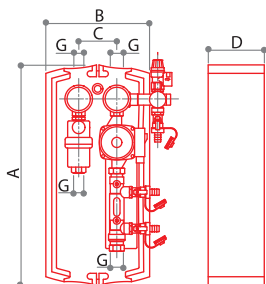

Inoltre i gruppi sono completi di valvole per l'intercettazione della pompa, rubinetti di carico e scarico, valvola di ritegno, valvola di sicurezza, flussimetro e coibentatura. Il disareatore/deareatore è presente solo sul modello GSP 1180.

GRUPPI POMPA PER SOLARE

**CSP 1180**

Gruppo pompa solare completo di valvole di intercettazione con termometri integrati, disaeratore/deareatore, rubinetti di carico/scarico, valvole di ritegno, valvola di sicurezza 6 bar, coibentatura e flussimetro range 0,5 - 15 l/min.

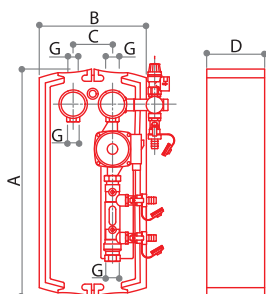

Temperatura massima d'esercizio 130 °C.

CODICE	MISURA	A	B	C	D	E	F	G	H	L			
72000010	G 3/4	440	250	125	115	-	-	G 3/4	-	-	5028	1	-

**CSP 1182**

Gruppo pompa solare completo di valvole di intercettazione con termometri integrati, rubinetti di carico/scarico, valvole di ritegno, valvola di sicurezza 6 bar, coibentatura e flussimetro range 0,5 - 15 l/min.

Temperatura massima d'esercizio 130 °C.

CODICE	MISURA	A	B	C	D	E	F	G	H	L			
72000012	G 3/4	440	250	125	115	-	-	G 3/4	-	-	4478	1	-

**CE 1370**

Centralina elettronica differenziale a microprocessore per impianti solari.

CODICE	MISURA			
69011470	-	530	1	-

**AC 1180**

Accessori per il collegamento dei gruppi pompa solare al vaso d'espansione con valvola di ritegno bidirezionale e staffa di fissaggio a muro.

CODICE	MISURA			
68559880	G 3/4	1116	1	-

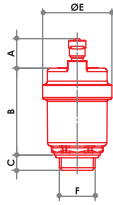

VS 604/S

Valvola sfogo aria automatica.
200°C - 10 bar.



Collaudo
100%

CODICE	MISURA	A	B	C	D	E	F	G	H	L			
67791017	G 3/8	17	50	9	-	40	G 3/8	-	-	-	138	10	100
67791021	G 1/2	17	50	9	-	40	G 1/2	-	-	-	138	10	100

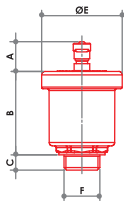

VS 601/S

Valvola di sfogo aria automatica tipo
medio. 200°C - 10 bar.



Collaudo
100%

CODICE	MISURA	A	B	C	D	E	F	G	H	L			
67790817	G 3/8	17	50	9	-	46	G 3/8	-	-	-	154	10	100
67790821	G 1/2	17	50	9	-	46	G 1/2	-	-	-	154	10	100
67790827	G 3/4	17	50	9	-	46	G 3/4	-	-	-	154	10	100

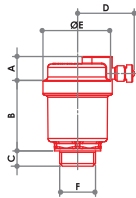

VS 603/S

Valvola sfogo aria automatica
con sfiato laterale. 200°C - 10 bar.



Collaudo
100%

CODICE	MISURA	A	B	C	D	E	F	G	H	L			
67790917	G 3/8	14	41	9	34	40	G 3/8	-	-	-	160	10	100
67790921	G 1/2	14	41	9	34	40	G 1/2	-	-	-	160	10	100

DIAGRAMMA DI PORTATA

VALVOLA DI REGOLAZIONE CON TESTA TERMOSTATICA

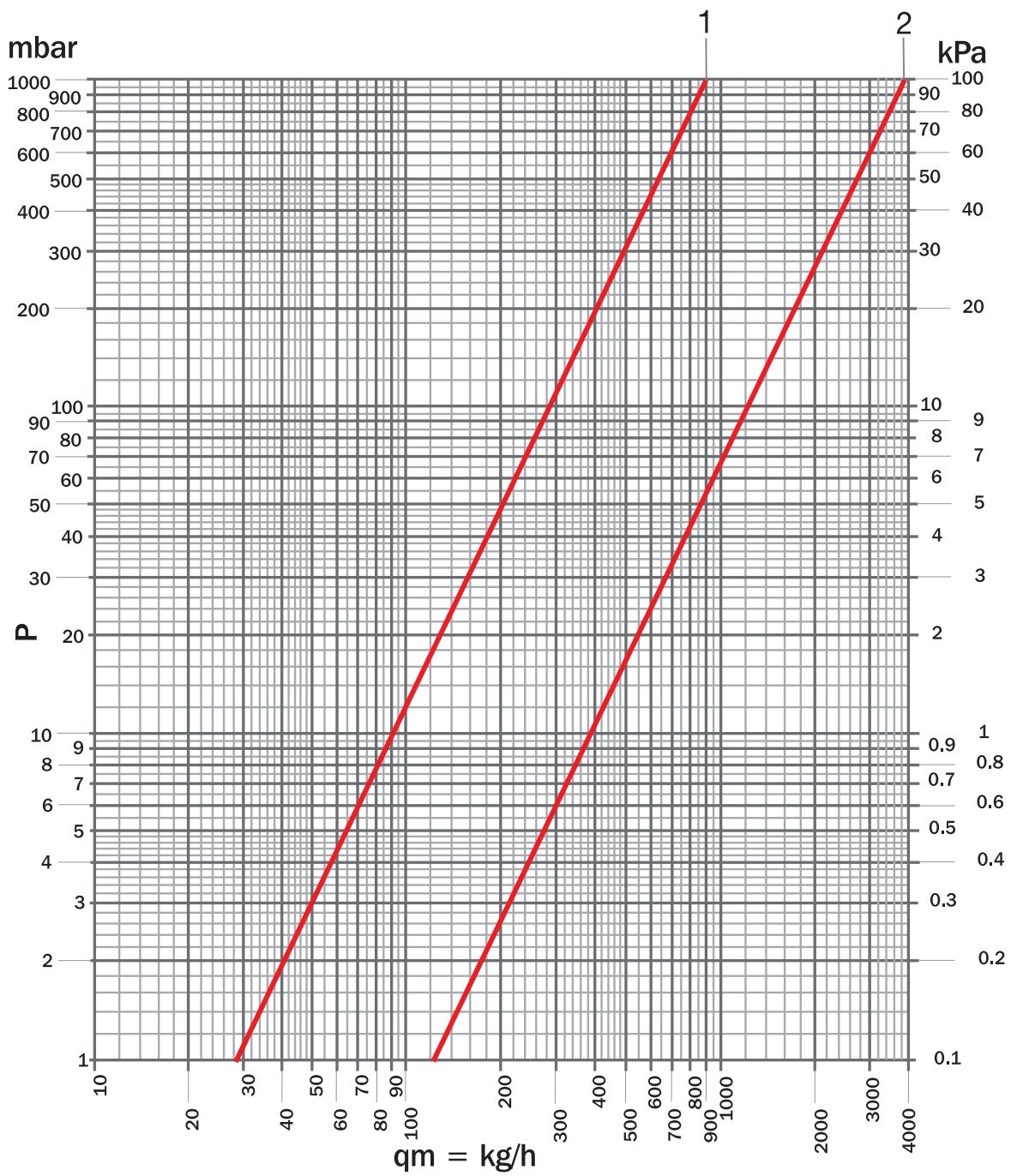

Kvs	REGOLAZIONE	POS
0,9	$\Delta T=2$ K	1
3,88	QM MAX	2

DIAGRAMMA DI PORTATA
VALVOLA DI INTERCETTAZIONE

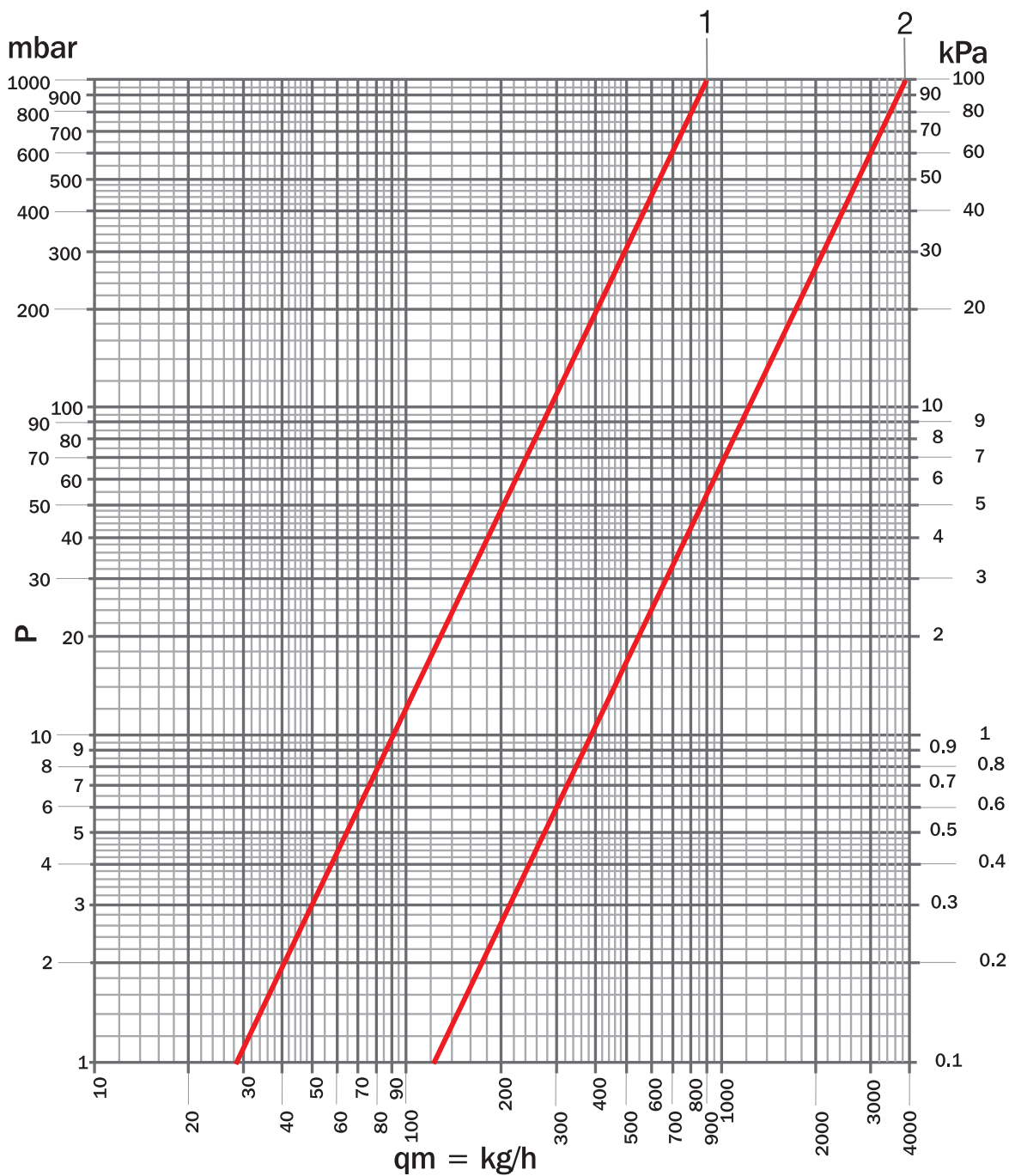

Kvs	REGOLAZIONE	POS
0,09	01/2	1
0,27	1	2
0,76	1+1/2	3
0,98	2	4
1,20	2+1/2	5
1,46	3	6
1,70	3+1/2	7
1,93	4	8
2,19	4+1/2	9
2,47	5	10
2,75	5+1/2	11
3,01	tutto aperto	12



LUXOR®

**5 / ACCESSORI ELETTRICI
ED ELETTRONICI**

TESTE TERMOELETTRICHE



CARATTERISTICHE TECNICHE

Le teste termoelettriche per il loro funzionamento sfruttano la dilatazione di un elemento termosensibile che, al momento in cui la valvola deve essere aperta, è scaldato tramite una resistenza elettrica. Questo funzionamento permette di avere un ciclo di apertura e chiusura lento, impedendo quindi all'impianto di subire "colpi d'ariete". Le teste termoelettriche devono essere collegate esclusivamente a termostati o cronotermostati del tipo on-off. Non si possono utilizzare termostati o cronotermostati a 3 punti o modulanti.

Le teste termoelettriche serie TE sono tutte del tipo normalmente chiuso. Le teste quindi si aprono solo quando dal sensore di comando (es. termostato) arriva il comando di apertura (tensione). Questo permette alla testa di lavorare solo quando c'è la necessità di passaggio di acqua calda o fredda attraverso il corpo scaldante e rimanere inattiva per tutto il restante periodo. Le nuove teste termoelettriche possono essere installate in qualunque posizione, anche capovolte, in quanto sono protette contro le eventuali perdite dei vitoni termostatici.

	TE 3010	TE 3011	TE 3012	TE 3013
tensione di alimentazione	230 V AC, +10%...-10%, 50/60 Hz	24 V AC/DC, +20%...-10%	230 V AC, +10%...-10%, 50/60 Hz	24 V AC/DC, +20%...-10%
max corrente in entrata	<550 mA per max 100 ms	<300 mA per max 2 min	<550 mA per max 100 ms	<300 mA per max 2 min
potenza di esercizio	1 W	1 W	1 W	1 W
corsa di regolazione	3.5 mm	3.5 mm	3.5 mm	3.5 mm
forza di regolazione	90 N +10%	90 N +10%	90 N +10%	90 N +10%
tensione/corrente di commutazione microinteruttore	-	-	230 V AC: carico resistivo 5 A, carico induttivo 1 A	24 V AC: carico resistivo 3 A, carico induttivo 1 A
punto di scatto NC	-	-	Ca. 2 mm	Ca. 2 mm
temperatura fluido	0÷100 °C	0÷100 °C	0÷100 °C	0÷100 °C
temperatura di stoccaggio	-25÷60 °C	-25÷60 °C	-25÷60 °C	-25÷60 °C
temperatura ambiente	0÷60 °C	0÷60 °C	0÷60 °C	0÷60 °C
grado di protezione	IP 54	IP 54	IP 54	IP 54
classe di protezione	II	III	II	III
conformità CE	EN 60730	EN 60730	EN 60730	EN 60730
materiale alloggiamento	Poliammide			
colore alloggiamento	Grigio chiaro RAL 7035			
cavi di alimentazione	2x0.75 mm ² PVC	2x0.75 mm ² PVC	4x0.75 mm ² PVC	4x0.75 mm ² PVC
colore cavo	Grigio chiaro RAL 7035			
lunghezza cavi	1 m	1 m	1 m	1 m
peso	100 g	100 g	Ca. 150 g	Ca. 150 g
resistenza alle sovratensioni conforme a EN 60730-1	2.5 kV	1 kV	2.5 kV	1 kV

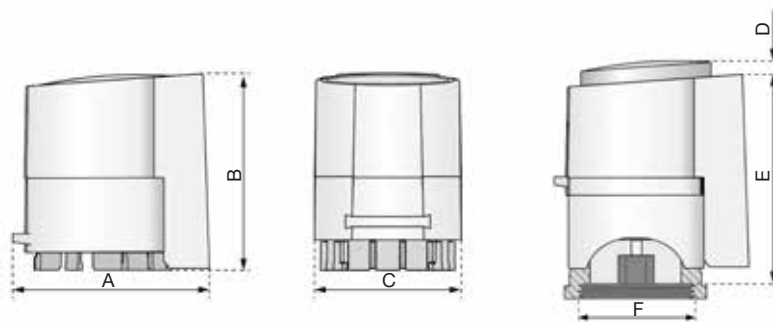

CODICE	MISURA	A	B	C	D	E	F	G	H	L
69011051	M30x1,5	49	47,5	36	7	51	M30x1,5	-	-	-
69011052		49	47,5	36	7	51		-	-	-
69011056		59	50	36	7	53,5		-	-	-
69011057		59	50	36	7	53,5		-	-	-

CURVE CARATTERISTICHE

TE 3010 - TE 3011

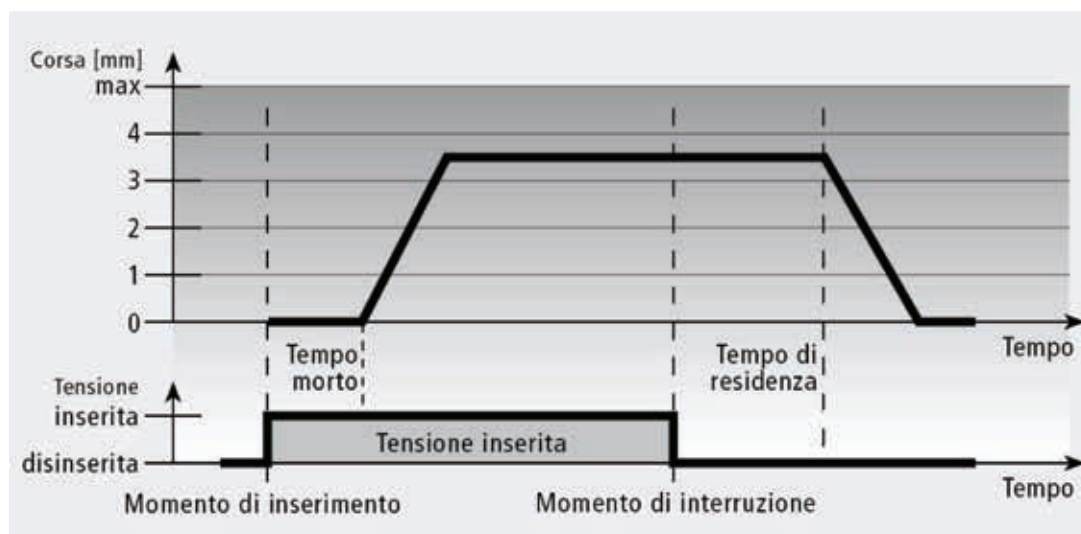

TE 3012 - TE 3013

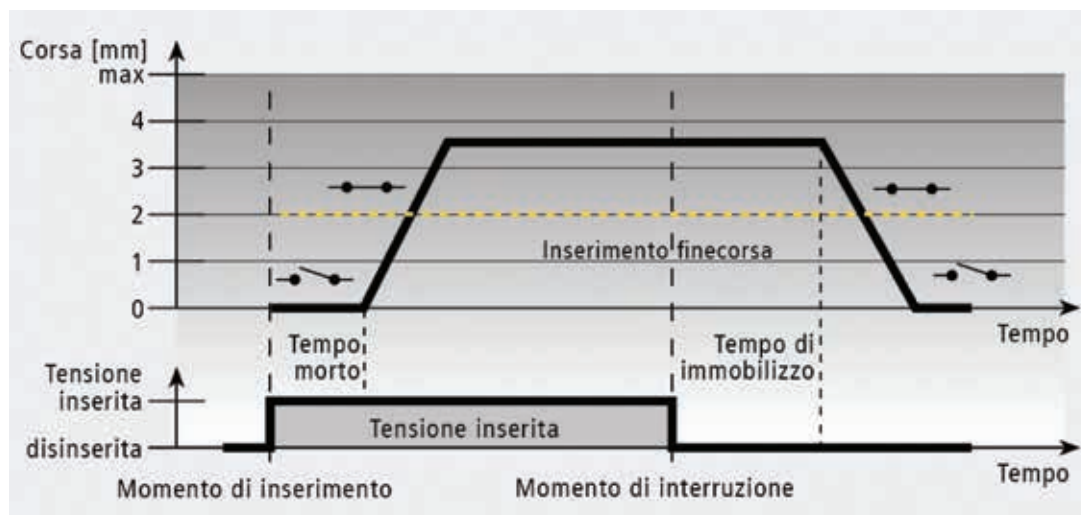

ISTRUZIONI DI MONTAGGIO: ASSEMBLAGGIO CON ADATTATORE PER VALVOLA

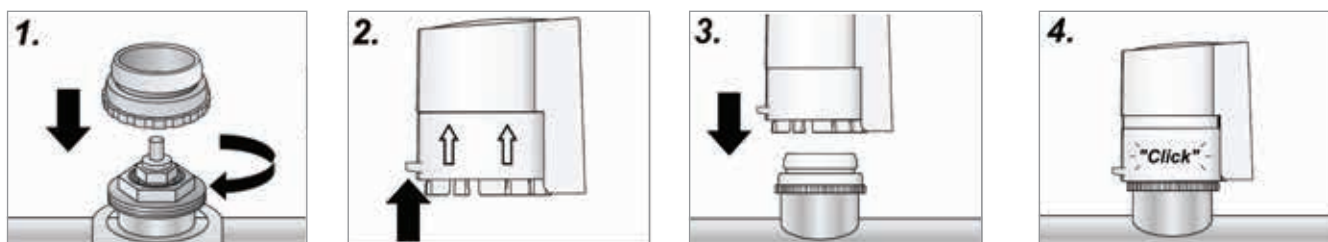

ISTRUZIONI PER IL MONTAGGIO DELLE TESTE TERMOELETTRICHE

- Avvitare completamente l'adattatore in plastica sul filetto del vitone termostatzabile (fig. 1);
- Spingere verso l'alto l'anello d'arresto della testa (fig. 2);

- Posizionare la testa perpendicolarmente alla valvola (fig. 3);
- Esercitando una lieve pressione con la mano, innestare la testa sull'adattatore: ciò avviene semplicemente premendo fino a quando non si sente uno scatto (fig. 4).

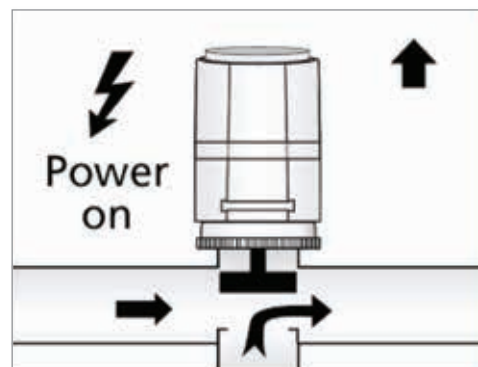
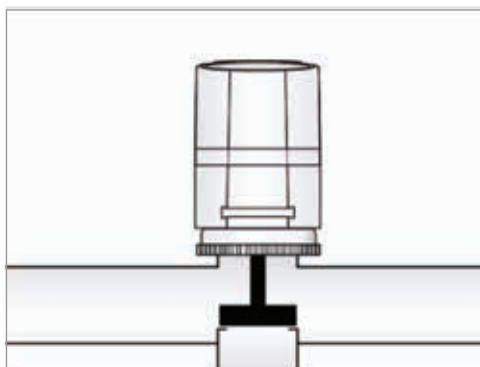

INDICAZIONI DI FUNZIONAMENTO

Con l'indicatore di funzionamento (indicatore circolare di colore azzurro) delle teste è possibile riconoscere con uno sguardo, e al buio sentire col tatto, se la valvola è aperta o chiusa. L'indicatore di funzionamento fuoriesce se la valvola si apre.

MESSA IN FUNZIONE DELLE TESTE TERMOELETTRICHE

Tutte le teste termoelettriche serie TE sono fornite in posizione bloccata e aperta per $\sim 1/4$.

Al momento della messa in servizio, per poter sbloccare la testa, deve essere data tensione per almeno 6 minuti (es. termostato collegato in posizione di riscaldamento). La testa durante questo periodo si aprirà completamente, e romperà il blocco.

A questo punto la testa è pronta per il suo normale funzionamento.

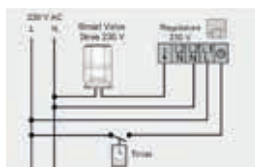

**TESTA TERMOELETTRICA
ART. TE 3010
COD. 69011051**

Teste termoelettriche 230V normalmente chiusa senza contatto di finecorsa.

Colore cavi elettrici di collegamento testa termoelettrica senza dispositivo di finecorsa con relativa descrizione.

COLORE FILO	DESCRIZIONE
marrone	cavo elettrico di collegamento testa termoelettrica alla "fase"
blu	cavo elettrico di collegamento testa termoelettrica al "neutro"

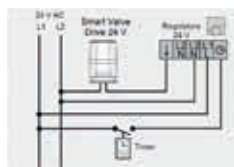

**TESTA TERMOELETTRICA
ART. TE 3011
COD. 69011052**

Teste termoelettriche 24V normalmente chiusa senza contatto di finecorsa.

Colore cavi elettrici di collegamento testa termoelettrica senza dispositivo di finecorsa con relativa descrizione.

COLORE FILO	DESCRIZIONE
marrone	cavo elettrico di collegamento testa termoelettrica alla "fase"
blu	cavo elettrico di collegamento testa termoelettrica al "neutro"

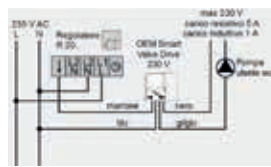

**TESTA TERMOELETTRICA
ART. TE 3012
COD. 69011056**

Teste termoelettriche 230V normalmente chiusa con contatto di finecorsa.

Colore cavi elettrici di collegamento testa termoelettrica con dispositivo di finecorsa con relativa descrizione.

COLORE FILO	DESCRIZIONE
marrone	cavo elettrico di collegamento testa termoelettrica alla "fase"
blu	cavo elettrico di collegamento testa termoelettrica al "neutro"
nero e grigio	cavi elettrici di uscita dal contatto ausiliario "finecorsa"

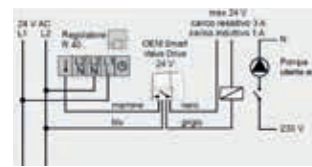

**TESTA TERMOELETTRICA
ART. TE 3013
COD. 69011057**

Teste termoelettriche 24V normalmente chiusa con contatto di finecorsa.

Colore cavi elettrici di collegamento testa termoelettrica con dispositivo di finecorsa con relativa descrizione.

COLORE FILO	DESCRIZIONE
marrone	cavo elettrico di collegamento testa termoelettrica alla "fase"
blu	cavo elettrico di collegamento testa termoelettrica al "neutro"
nero e grigio	cavi elettrici di uscita dal contatto ausiliario "finecorsa"



COLLEGAMENTI PER LE TESTE TERMOELETTRICHE

Le uscite dei termostati e/o cronotermostati alle quali collegare i cavi elettrici delle teste termoelettriche sono generalmente come quelle indicate nel seguente schema:

Dove:

C: entrata per il cavo di alimentazione proveniente dalla rete elettrica.

N.C.: uscita normalmente chiusa per il cavo di alimentazione proveniente dalla testa termoelettrica (non utilizzare in quanto la nostra testa termoelettrica è normalmente chiusa).

N.A.: uscita normalmente aperta per il cavo proveniente dalla testa termoelettrica (il cavo elettrico proveniente dalla testa termoelettrica di colore marrone deve essere collegato a questo tipo di uscita).

ESEMPIO DI APPLICAZIONE CON COLLEGAMENTI:

- 1 cronotermostato
- 1 testa termoelettrica

Ad ogni termostato o cronotermostato possono essere collegate in serie normalmente fino a 10 teste termoelettriche fra loro in parallelo. Per sapere esattamente quante teste è possibile collegare, occorre dividere il valore di portata del contatto di uscita N.A. del termostato, per l'assorbimento di spunto delle teste.

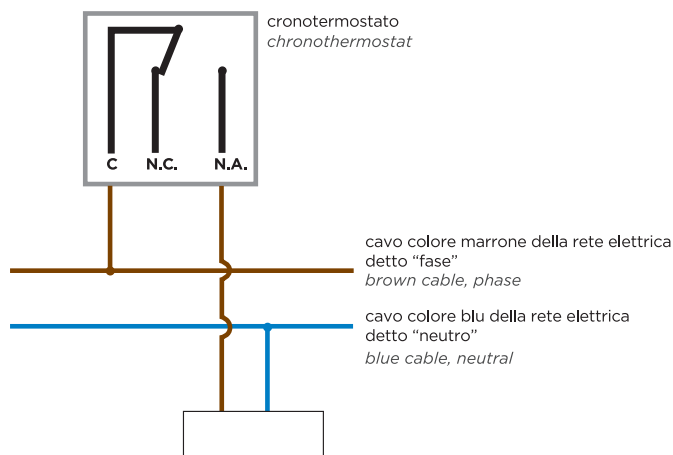

ESEMPIO DI APPLICAZIONE CON COLLEGAMENTI

- 1 cronotermostato
- 3 teste termoelettriche collegate in parallelo

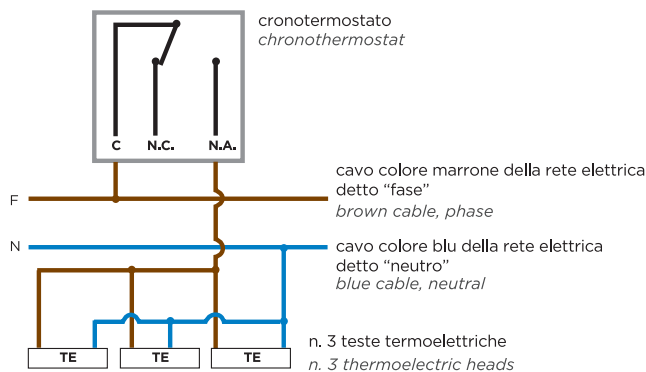

(fig. 1)

TESTE TERMOSTATICHE CON CONTATTO AUSILIARIO O "FINECORSA"

Il contatto ausiliario di finecorsa è utilizzato con lo scopo di dare avvio alla pompa di circolazione dell'impianto riscaldante quando c'è almeno una testa termoelettrica attiva (in funzione), e dunque impedire alla pompa di funzionare quando

tutte le valvole termostatiche sono chiuse. Questo dispositivo, disattivando la pompa quando non è possibile la circolazione nell'impianto, riduce l'usura della pompa stessa ed i rumori dovuti alla cavitazione.

Teste termoelettriche con contatto di fine corsa art. TE 3012
Thermostatic head with limit switch art. TE 3012

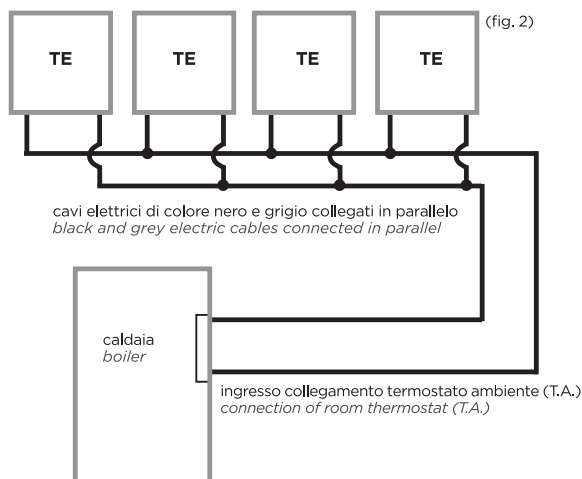

Teste termoelettriche con contatto di fine corsa art. TE 3012
Thermostatic head with limit switch art. TE 3012

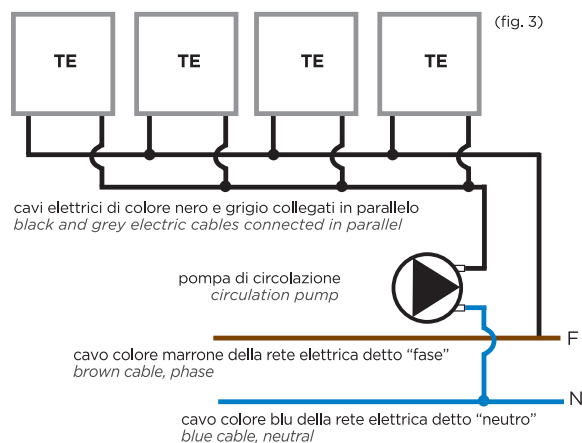

TESTE TERMEOLETTICHE

**TE 3010**

Testa termoelettrica 230 V
(normalmente in posizione di chiusura
- con tensione apre)

- tensione di alimentazione 230 VAC
- cavo di alimentazione 2 fili x 0,75 mm².

Lunghezza 1000 mm.

ARTICOLO IN ESAURIMENTO.

CODICE	MISURA			
69011051	M30x1,5	100	1	100

**TE 3011**

Testa termoelettrica 24 V
(normalmente in posizione di chiusura
- con tensione apre)

- tensione di alimentazione 24 VAC
- cavo di alimentazione 2 fili x 0,75 mm².

Lunghezza 1000 mm.

ARTICOLO IN ESAURIMENTO.

CODICE	MISURA			
69011052	M30x1,5	100	1	100



**TE 3012**

Testa termoelettrica 230 V con contatto
di finecorsa (normalmente in posizione
di chiusura - con tensione apre)

- tensione di alimentazione 230 VAC
- cavo di alimentazione 4 fili x 0,75 mm².

Lunghezza 1000 mm.

ARTICOLO IN ESAURIMENTO.

CODICE	MISURA			
69011056	M30x1,5	150	1	100



Finecorsa

**TE 3013**

Testa termoelettrica 24 V con contatto
di finecorsa (normalmente in posizione
di chiusura - con tensione apre)

- tensione di alimentazione 24 VAC
- cavo di alimentazione 4 fili x 0,75 mm².

Lunghezza 1000 mm.

ARTICOLO IN ESAURIMENTO.

CODICE	MISURA			
69011057	M30x1,5	150	1	100



Finecorsa

VA 3090S

Adattatore di ricambio per teste
termoelettriche serie TE.

ARTICOLO IN ESAURIMENTO.



CODICE	MISURA			
69015024	M30x1,5	8	-	-

TESTE TERMOELETTRICHE



CARATTERISTICHE TECNICHE

Le teste termoelettriche per il loro funzionamento sfruttano la dilatazione di un elemento termosensibile, che al momento in cui la valvola deve essere aperta è scaldato tramite una resistenza elettrica. Questo funzionamento permette di avere un ciclo di apertura e chiusura lento, impedendo quindi all'impianto di subire "colpi d'ariete". Le teste termoelettriche devono essere collegate esclusivamente a termostati o cronotermostati del tipo on-off. Non si possono utilizzare termostati o cronotermostati a 3 punti o modulanti.

Le teste termoelettriche serie TE sono tutte del tipo normalmente chiuso. Le teste quindi si aprono solo quando dal sensore di comando (es. termostato) arriva il comando di apertura (tensione). Questo permette alla testa di lavorare solo quando c'è la necessità di passaggio di acqua calda o fredda attraverso il corpo scaldante e rimanere inattiva per tutto il restante periodo. Le nuove teste termoelettriche possono essere installate in qualunque posizione, anche capovolte, in quanto sono protette contro le eventuali perdite dei vitoni termostatici.

	TE 3110	TE 3111	TE 3112	TE 3113
tensione di alimentazione	230 V AC, +10%...-10%, 50/60 Hz	24 V AC/DC +20%...-10%, 0-60 Hz	230 V AC, +10%...-10%, 50/60 Hz	24 V AC/DC, +20%...-10%, 50/60 Hz
max corrente in entrata	350 mA	200 mA	350 mA	200 mA
potenza di esercizio	1 W	1 W	1 W	1 W
corsa di regolazione	5 mm	5 mm	5 mm	5 mm
forza di regolazione	100 N +10%	100 N +10%	100 N +10%	100 N +10%
tensione/corrente di commutazione microinteruttore	-	-	230 V AC: carico resistivo 5 A carico induttivo 1 A	24 V AC: carico resistivo 5 A carico induttivo 1 A 24 V DC: carico resistivo 3 A carico induttivo 1 A
punto di scatto NC	-	-	2,6 ± 0,6 mm	2,6 ± 0,6 mm
temperatura fluido	0÷100 °C	0÷100 °C	0÷100 °C	0÷100 °C
temperatura di stoccaggio	-25÷60 °C	-25÷60 °C	-25÷60 °C	-25÷60 °C
temperatura ambiente	0÷60 °C	0÷60 °C	0÷60 °C	0÷60 °C
grado di protezione	IP 54	IP 54	IP 54	IP 54
classe di protezione	II	III	II	III
conformità CE	✓	✓	✓	✓
materiale alloggiamento	Poliammide			
colore alloggiamento	Grigio			
cavi di alimentazione	2x0.75 mm ² PVC	2x0.75 mm ² PVC	4x0.75 mm ² PVC	4x0.75 mm ² PVC
colore cavo	Grigio			
lunghezza cavi	1 m	1 m	1 m	1 m
peso	105 g	105 g	160 g	160 g
resistenza alle sovratensioni	2.5 kV	1 kV	2.5 kV	1 kV



CODICE	ARTICOLO	MISURA	A	B	C	D	E	F	G	H
69011021	TE 3110	M30x1,5	50	54	44	5,5	-	M30x1,5	-	-
69011022	TE 3111		50	54	44	5,5	-		-	-
69011026	TE 3112		56	54	44	4	-		-	-
69011027	TE 3113		56	54	44	4	-		-	-

CURVE CARATTERISTICHE

TE 3110 - TE 3111

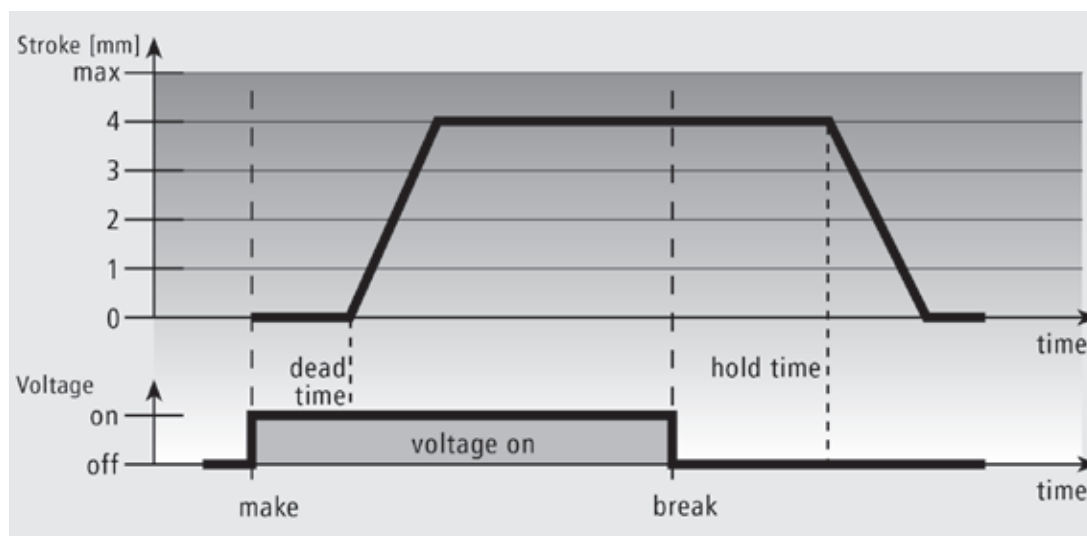

TE 3112 - TE 3113

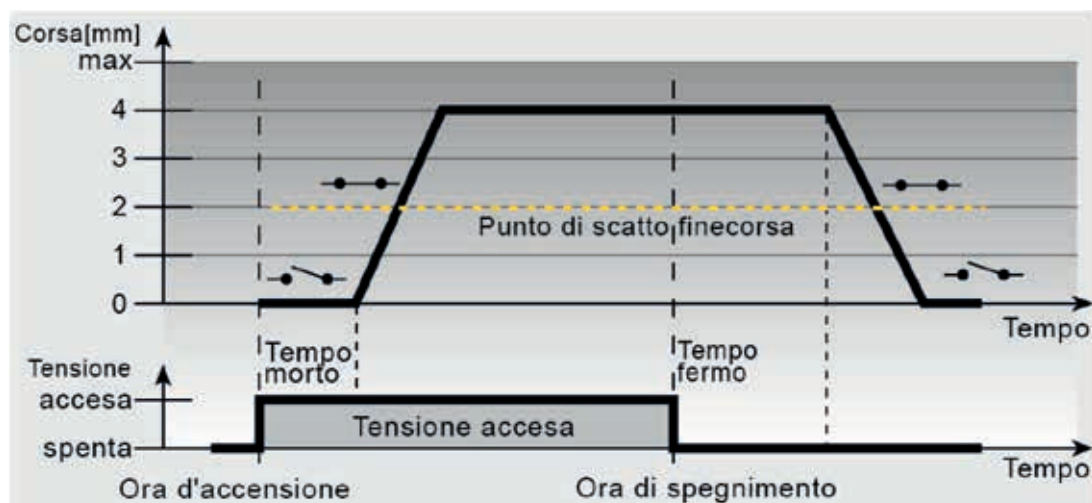

ISTRUZIONI DI MONTAGGIO: ASSEMBLAGGIO CON ADATTATORE PER VALVOLA

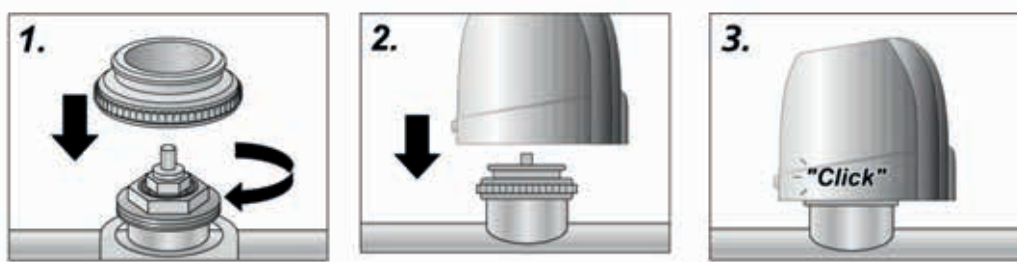

ISTRUZIONI PER IL MONTAGGIO DELLE TESTE TERMoeLETTRICHE

- Avvitare a mano l'adattatore per valvole sulla valvola. (fig.1);
- Posizionare a mano, verticalmente, l'azionatore sull'adattatore per valvole. (fig.2);
- Esercitando con la mano una pressione verticale sull'azionatore, questo viene facilmente incastrato sull'adattatore per valvole; l'incastrò è chiaramente udibile. (fig.3).

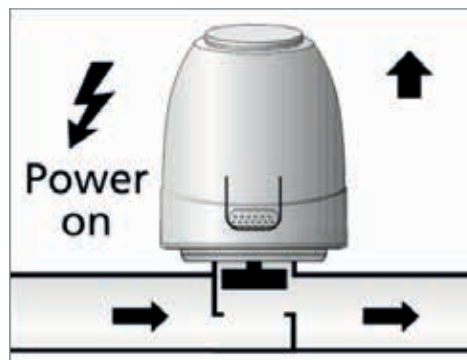
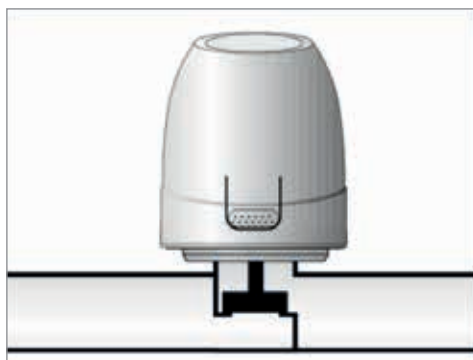

INDICAZIONI DI FUNZIONAMENTO

Con l'indicatore di funzionamento (indicatore circolare di colore azzurro o rosso) delle teste è possibile riconoscere con uno sguardo, e al buio sentire col tatto, se la valvola è aperta o chiusa. L'indicatore di funzionamento fuoriesce se la valvola si apre.

MESSA IN FUNZIONE DELLE TESTE TERMoeLETTRICHE

Tutte le teste termoelettriche serie TE sono fornite in posizione bloccata e aperta per $\sim 1/4$.

Al momento della messa in servizio, per poter sbloccare la testa, deve essere data tensione per almeno 6 minuti (es. termostato collegato in posizione di riscaldamento). La testa durante questo periodo si aprirà completamente, e romperà il blocco.

A questo punto la testa è pronta per il suo normale funzionamento.

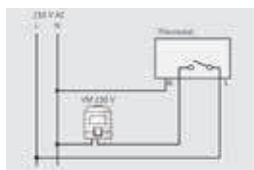

**TESTA TERMOELETTRICA
ART. TE 3110
COD. 69011021**

Teste termoelettriche 230V normalmente chiusa senza contatto di finecorsa.

Colore cavi elettrici di collegamento testa termoelettrica senza dispositivo di finecorsa con relativa descrizione.

COLORE FILO	DESCRIZIONE
marrone	cavo elettrico di collegamento testa termoelettrica alla "fase"
blu	cavo elettrico di collegamento testa termoelettrica al "neutro"

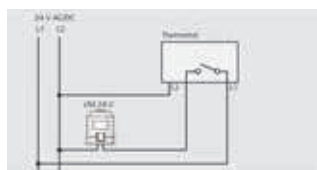

**TESTA TERMOELETTRICA
ART. TE 3111
COD. 69011022**

Teste termoelettriche 24V normalmente chiusa senza contatto di finecorsa.

Colore cavi elettrici di collegamento testa termoelettrica senza dispositivo di finecorsa con relativa descrizione.

COLORE FILO	DESCRIZIONE
marrone	cavo elettrico di collegamento testa termoelettrica alla "fase"
blu	cavo elettrico di collegamento testa termoelettrica al "neutro"

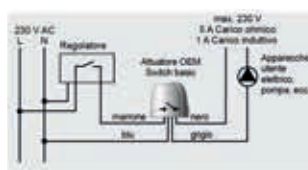

**TESTA TERMOELETTRICA
ART. TE 3112
COD. 69011026**

Teste termoelettriche 230V normalmente chiusa con contatto di finecorsa.

Colore cavi elettrici di collegamento testa termoelettrica con dispositivo di finecorsa con relativa descrizione.

COLORE FILO	DESCRIZIONE
marrone	cavo elettrico di collegamento testa termoelettrica alla "fase"
blu	cavo elettrico di collegamento testa termoelettrica al "neutro"
nero e grigio	cavi elettrici di uscita dal contatto ausiliario "finecorsa"

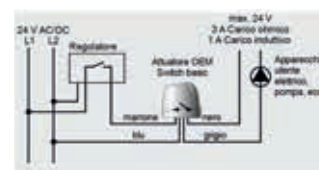

**TESTA TERMOELETTRICA
ART. TE 3113
COD. 69011027**

Teste termoelettriche 24V normalmente chiusa con contatto di finecorsa.

Colore cavi elettrici di collegamento testa termoelettrica con dispositivo di finecorsa con relativa descrizione.

COLORE FILO	DESCRIZIONE
marrone	cavo elettrico di collegamento testa termoelettrica alla "fase"
blu	cavo elettrico di collegamento testa termoelettrica al "neutro"
nero e grigio	cavi elettrici di uscita dal contatto ausiliario "finecorsa"



COLLEGAMENTI PER LE TESTE TERMOELETTRICHE

Le uscite dei termostati e/o cronotermostati alle quali collegare i cavi elettrici delle teste termoelettriche sono generalmente come quelle indicate nel seguente schema:

Dove:

C: entrata per il cavo di alimentazione proveniente dalla rete elettrica.

N.C.: uscita normalmente chiusa per il cavo di alimentazione proveniente dalla testa termoelettrica (non utilizzare in quanto la nostra testa termoelettrica è normalmente chiusa).

N.A.: uscita normalmente aperta per il cavo proveniente dalla testa termoelettrica (il cavo elettrico proveniente dalla testa termoelettrica di colore marrone deve essere collegato a questo tipo di uscita).

ESEMPIO DI APPLICAZIONE CON COLLEGAMENTI:

- 1 cronotermostato
- 1 testa termoelettrica

Ad ogni termostato o cronotermostato possono essere collegate in serie normalmente fino a 10 teste termoelettriche fra loro in parallelo. Per sapere esattamente quante teste è possibile collegare, occorre dividere il valore di portata del contatto di uscita N.A. del termostato, per l'assorbimento di spunto delle teste.

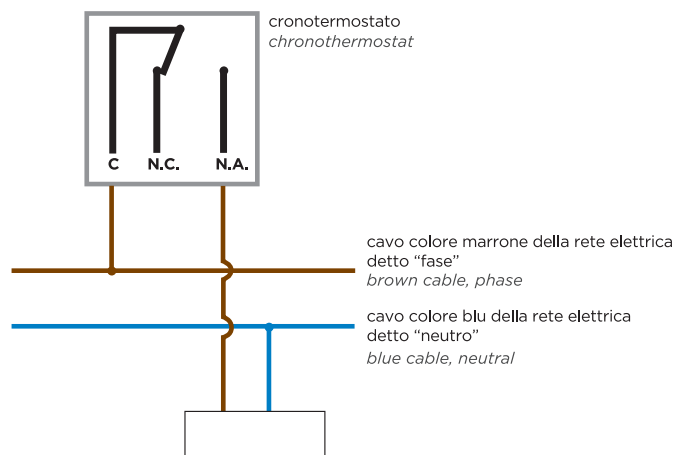

ESEMPIO DI APPLICAZIONE CON COLLEGAMENTI

- 1 cronotermostato
- 3 teste termoelettriche collegate in parallelo

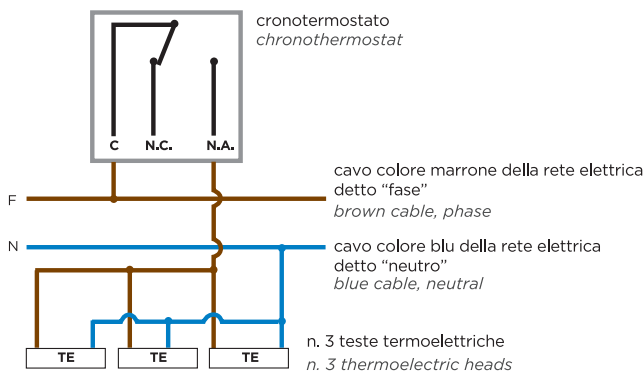

(fig. 1)

TESTE TERMOSTATICHE CON CONTATTO AUSILIARIO O "FINECORSA"

Il contatto ausiliario di finecorsa è utilizzato con lo scopo di dare avvio alla pompa di circolazione dell'impianto riscaldante quando c'è almeno una testa termoelettrica attiva (in funzione), e dunque impedire alla pompa di funzionare quando

tutte le valvole termostatiche sono chiuse. Questo dispositivo, disattivando la pompa quando non è possibile la circolazione nell'impianto, riduce l'usura della pompa stessa ed i rumori dovuti alla cavitazione.

Teste termoelettriche con contatto di fine corsa art. TE 3112
Thermostatic head with limit switch art. TE 3112

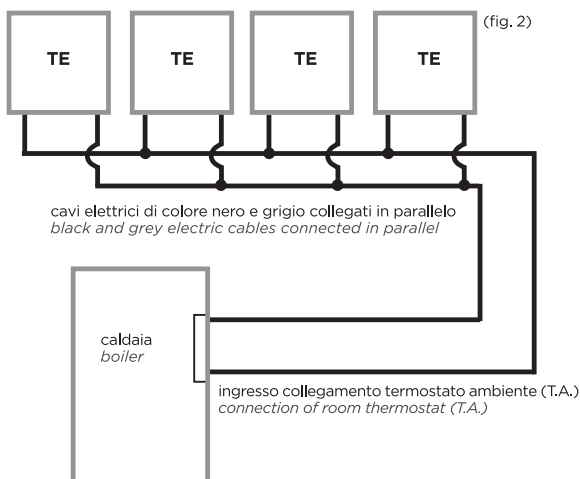

Teste termoelettriche con contatto di fine corsa art. TE 3112
Thermostatic head with limit switch art. TE 3112

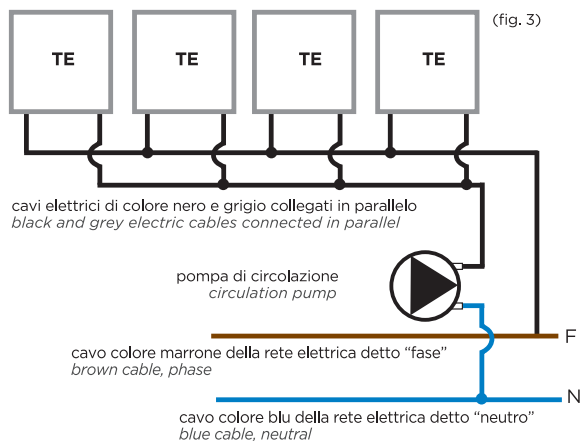

TESTE TERMOELETTRICHE

TE 3110

Testa termoelettrica 230 V
(normalmente in posizione di chiusura
- con tensione apre)

- tensione di alimentazione 230 VAC
- cavo di alimentazione **2 fili** x 0,75 mm².

Lunghezza 1000 mm.

CODICE	MISURA			
69011021	M30x1,5	105	1	100

TE 3111

Testa termoelettrica 24 V
(normalmente in posizione di chiusura
- con tensione apre)

- tensione di alimentazione 24 VAC
- cavo di alimentazione **2 fili** x 0,75 mm².

Lunghezza 1000 mm.

CODICE	MISURA			
69011022	M30x1,5	105	1	100

TE 3112

Testa termoelettrica 230 V con contatto
di finecorsa (normalmente in posizione
di chiusura - con tensione apre)

- tensione di alimentazione 230 VAC
- cavo di alimentazione **4 fili** x 0,75 mm².

Lunghezza 1000 mm.



CODICE	MISURA			
69011026	M30x1,5	160	1	100

**TE 3113**

Testa termoelettrica 24 V con contatto
di finecorsa (normalmente in posizione
di chiusura - con tensione apre)

- tensione di alimentazione 24 VAC
- cavo di alimentazione **4 fili** x 0,75 mm².

Lunghezza 1000 mm.

CODICE	MISURA			
69011027	M30x1,5	160	1	100

**VA 3090**

Adattatore di ricambio per teste
termoelettriche serie TE.

CODICE	MISURA			
69015023	M30x1,5	8	-	-



TERMOSTATI DI SICUREZZA A CONTATTO E AD IMMERSIONE

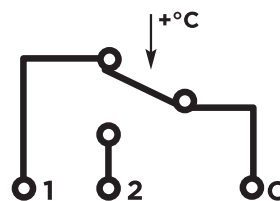

Collegamento elettrico
Electrical connection

CARATTERISTICHE TECNICHE

Termostato a contatto

Campo di regolazione della temperatura: 0 °C ÷ 90 °C

Gradiente termico: 1 °C/min

Tolleranza temperatura minima ±4 °C

Tolleranza temperatura massima ±6 °C

Differenziale: 8±12 °C

Portata nominale dei contatti:

- 16 (4)A 250 V-
- 6 (1)A 400 V-

Tensione impulsiva nominale 4 kV

Limite temperatura della testa di comando: 85 °C

Grado protezione: IP 40

Classe isolamento: I

Termostato ad Immersione

Campo di regolazione della temperatura: 10 °C ÷ 90 °C

Gradiente termico: 1 °C/min

Differenziale: 6±1 °C

Portata nominale dei contatti:

- 15 (6)A / 250 V-

Limite temperatura della testa di comando: 85 °C

Grado protezione: IP 40

Classe isolamento: I

CARATTERISTICHE COSTRUTTIVE

Il termostato di sicurezza serve a mantenere la temperatura dell'acqua in un impianto di riscaldamento entro assegnati valori e in particolare lontano dalla temperatura critica dell'acqua.

I termostati di sicurezza TS 3030, TS 3035, TS 3032, TS 3037 e TS 3050 sono termostati a contatto o a immersione.

Questi termostati possono avere un funzionamento sia normalmente aperto sia normalmente chiuso. La scelta sul tipo di funzionamento è fatta durante il collegamento elettrico.

Collegamento elettrico:

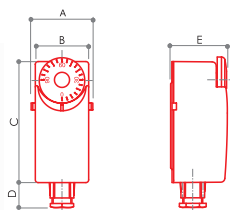

- Morsetto C: entrata comune;
- Morsetto 1: apre il circuito con l'aumentare della temperatura
- Morsetto 2: chiude il circuito con l'aumentare della temperatura

In generale, negli impianti di riscaldamento, l'utilizzatore è collegato ai morsetti C e 1 del termostato.



TS 3030

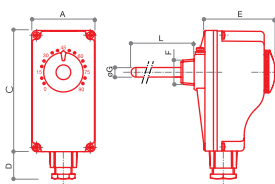

Termostato bimetallico di sicurezza a contatto: può essere impostato normalmente chiuso o aperto durante l'installazione.

CODICE	MISURA	A	B	C	D	E	F	G	H	L			
69011230	-	45	38	88	18	42	-	-	-	-	132	1	10



TS 3037

Termostato di sicurezza con sonda ad espansione di liquido ad immersione senza pozzetto: può essere impostato normalmente chiuso o aperto durante l'installazione.

CODICE	MISURA	A	B	C	D	E	F	G	H	L			
69011237	-	40	-	70	10	43	16	6,5	-	105	128	1	8

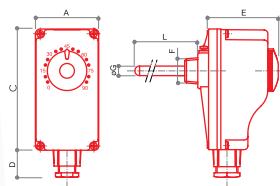

TS 3035

Termostato di sicurezza con sonda ad espansione di liquido ad immersione con pozzetto: può essere impostato normalmente chiuso o aperto durante l'installazione.

CODICE	MISURA	A	B	C	D	E	F	G	H	L			
69011235	G 1/2	40	-	70	10	43	16	6,5	-	105	128	1	8

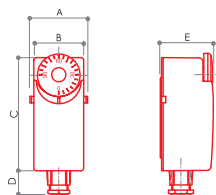

TS 3032

Termostato bimetallico di sicurezza a contatto precablato normalmente chiuso.

CODICE	MISURA	A	B	C	D	E	F	G	H	L			
69011232	-	45	38	88	18	42	-	-	-	-	250	1	8

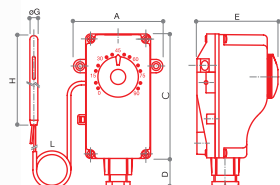

TS 3050

Termostato di sicurezza con sonda ad espansione di liquido ad immersione può essere normalmente chiuso o aperto durante l'installazione.

CODICE	MISURA	A	B	C	D	E	F	G	H	L			
69011250	-	40	-	70	10	43	-	6,5	73	1000	132	1	8

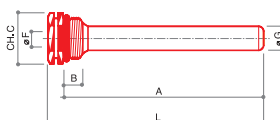

PS 541

Pozzetto giallo per sonda TS 3050 e TS 3037.

CODICE	MISURA	A	B	C	D	E	F	G	H	L			
9446952	G 1/2	100	10	22	-	-	7	12	-	108	84	20	160

POMPA DI CIRCOLAZIONE



CARATTERISTICHE TECNICHE

	PCEEI 752	PCE 756	PCE 757
EEL	≤ 0.20	$< 0,23$	$< 0,23$
temperatura liquido	$2 \div 95 \text{ }^\circ\text{C}$	$-10 \div 95 \text{ }^\circ\text{C}$	$-10 \div 90 \text{ }^\circ\text{C}$
temperatura ambiente	$0 \div 40 \text{ }^\circ\text{C}$	$0 \div 40 \text{ }^\circ\text{C}$	$0 \div 40 \text{ }^\circ\text{C}$
max pressione	6 bar	6 bar	6 bar
max quantità glicole	40 %	20 %	20 %
attacchi filettati secondo	ISO 228 G 1"1/2	ISO 228 G 1"1/2	ISO 228 G 1"1/2
tensione alimentazione	230 V (-10%; +6%)	230 V (-15%; 10%)	230 V (-15%; 10%)
frequenza	50/60 HZ	50/60 HZ	50/60 HZ
protezione	IP 44	IP 44	IP 44
classe isolamento	H	H	H

CURVE CARATTERISTICHE

PCEEI 752

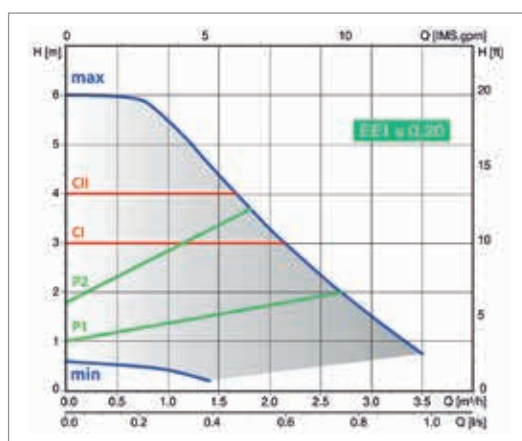

CI-CII curva costante
 P1-P2 curva proporzionale
 min-max n curve fisse

PCE 756

ΔP costante

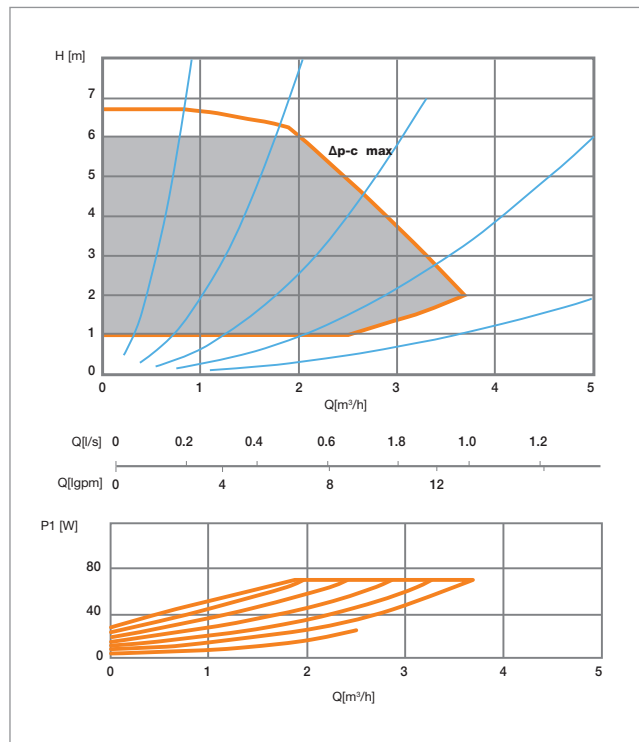

ΔP variabile

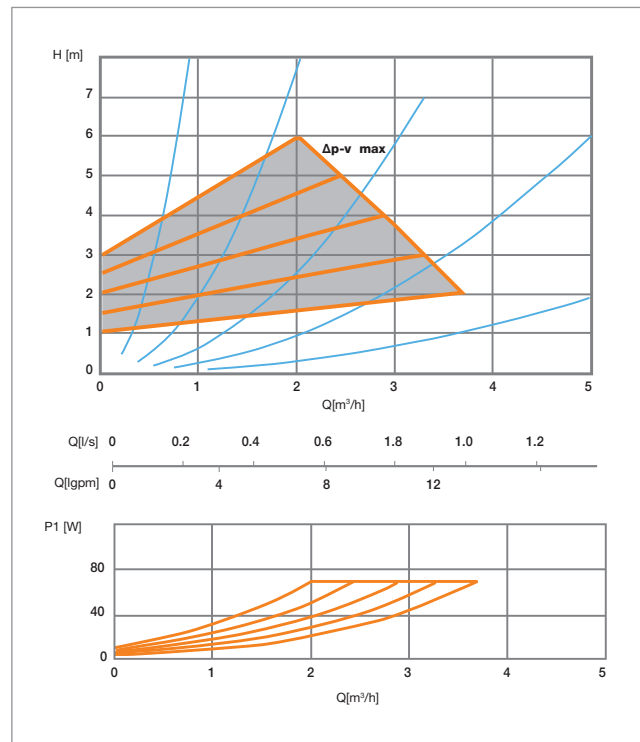

PCE 757

ΔP costante

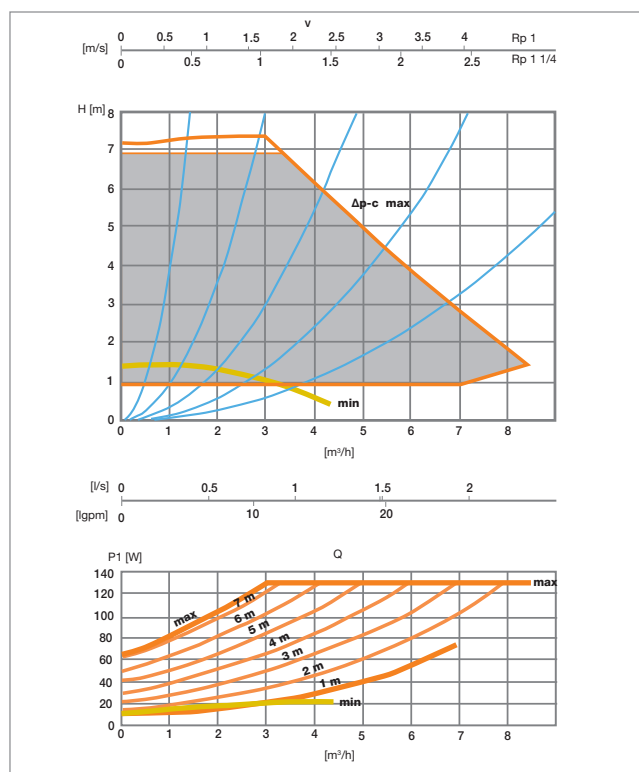

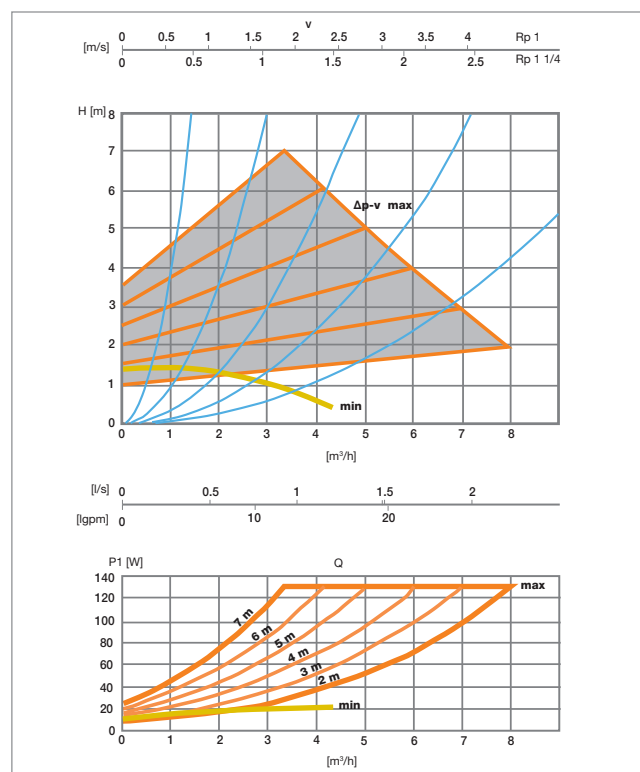

ΔP variabile

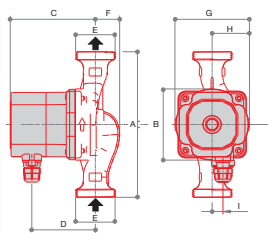

POMPA DI CIRCOLAZIONE

**PCEEI 752**

Pompa di circolazione elettronica con motore sincrono 25/60 interasse 130 mm.

CODICE	MISURA	A	B	C	D	E	F	G	H	I			
69011558	25/60-INT. 130 mm	130	88	104.5	78	G1"1/2	29.5	90	45	13.2	1810	1	-

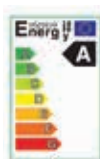
**PCE 756**

Pompa di circolazione elettronica con motore sincrono 25/70, interasse 130 mm.

CODICE	MISURA			
69011562	25/70-INT. 130 mm	2036	1	-

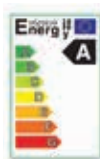

**PCE 757**

Pompa di circolazione elettronica con motore sincrono 25/80, interasse 180 mm.

CODICE	MISURA			
69011564	25/80-INT. 180 mm	3718	1	-

**VP 5012**

Valvole a sfera per pompe con attacco femmina G 1" e dado girevole da G 1"1/2.

CODICE	MISURA			
68559752	G 1"1/2 x G 1"	314	10	80

**TZ 800**

Tronchetto distanziatore zincato per collaudo impianti, interasse 130 mm.

CODICE	MISURA			
7116601	G 1"1/2	676	3	24

SERVOMOTORI



Servomotori con desing moderno per valvole Luxor con segnale di uscita in commutazione, in combinazione con sistemi di regolazione per singolo ambiente. Forza di azionamento di 150 N. Lunga durata grazie alla tecnologia del motore passo-passo, elevata sicurezza funzionale e lunga durata utile prevista. Servomotori a basso consumo energetico con sistema di adattamento valvole. Installazione plug-in semplice. Custodia ermeticamente sigillata: IP54 per la posizione di installazione a 360° e quindi protezione al 100% in caso di fuoriuscite. Servomotori a basso rumore e senza bisogno di manutenzione. Montaggio sulle valvole mediante filettatura M30x1.5.

MATERIALI COSTRUTTIVI

Materiale dell'involucro / colore:

Poliammide, Grigio chairo RAL 7035.

Coperchio del rivestimento / colore:

Policarbonato, Trasparente.

CARATTERISTICHE TECNICHE

	SM 1346	SM 1348
tensione di alimentazione	230V AC -10...+10% 50...60 Hz	24V AC, -10...+20% 50 - 60 HZ
tensione di controllo	-	0-10 V/PWM
consumo energetico	< 20 MA	< 110 MA
corrente di standby	< 5 mA	10 MA
potenza di funzionamento	3.5 VA	2.6 VA / 1.4 W
corsa	8.5 mm	
tempo di marcia (4 mm / 5 mm)	15 s/mm	
forza di azionamento	150 N (-20% / +40%)	
temperatura di esercizio alla valvola	0÷100 °C	
temperatura di stoccaggio	-25÷70 °C	
temperatura ambiente	0÷50 °C	
grado di protezione	IP 54	
classe di protezione	II	III
conformità secondo CE	EN 60730	
display LC	-	per direzione funzionamento, posizione, voltage di controllo, errori
impostazione manuale	con cacciavite 0,3 x 2 mm	
cavi di alimentazione	3x0.75 mm ² PVC, bianco	3x0.22 mm ² PVC, bianco
lunghezza cavi alimentazione	1 m	

ISTRUZIONI OPERATIVE

IMPOSTAZIONE MANUALE DELLA CORSA



1. Rimuovere la cavo di connessione e il tappo di protezione.

2. Introdurre il cacciavite da 0,3 x 2 mm nel dispositivo di regolazione della corsa manuale.

3. Girare a destra o a sinistra per estrarre o ritrarre.

4. Rimuovere il cacciavite dopo aver raggiunto la posizione desiderata.

5. Installare la protezione protettiva e collegare il cavo di connessione.

INSTALLAZIONE CON L'ADATTATORE

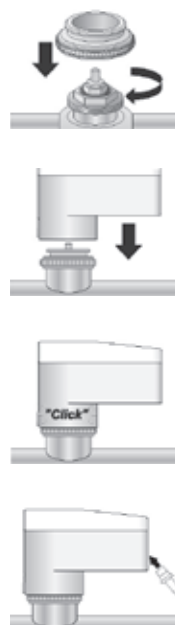

1. Avvitare manualmente l'adattatore della valvola sul vitone.

2. Posizionare manualmente il servomotore in posizione verticale sull'adattatore.

3. Agganciare manualmente il servomotore all'adattatore della valvola applicando una pressione verticale fino a sentire il tipico "click".

4. Collegare il cavo di connessione al servomotore.

POSIZIONE DI INSTALLAZIONE



VERTICALE

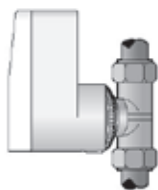

ORIZZONTALE

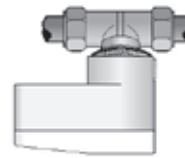

CAPOVOLTO

Il servomotore può essere utilizzato in ogni posizione di installazione.

Le posizioni preferite di installazione da utilizzare, dove possibile, sono orizzontale o verticale.

L'installazione "capovolto", in circostanze particolari (ad esempio acqua di scarico), può ridurre la durata del servomotore.

DIAGRAMMI DI FUNZIONAMENTO

SM 1346

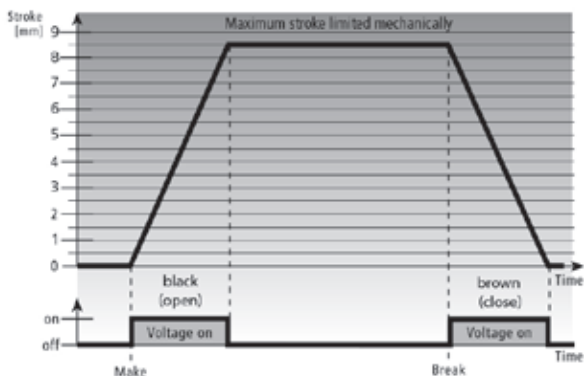

SM 1348

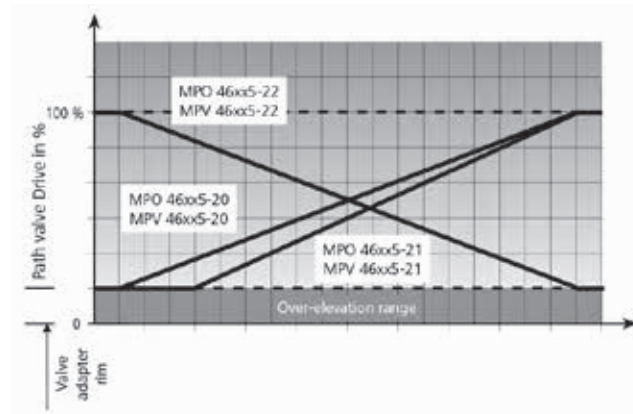

COLLEGAMENTI ELETTRICI

SM 1346

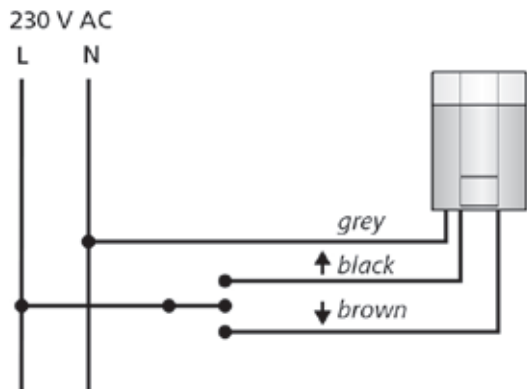

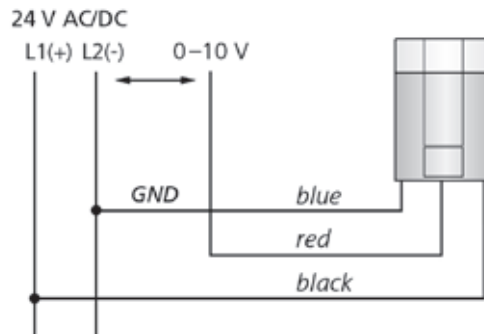

SM 1348

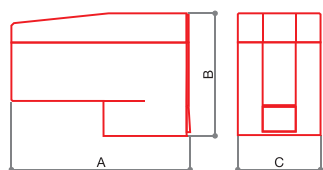

SERVOMOTORI



**SM 1346**

Servomotore a 3 punti con alimentazione 230 V e con attacco M30x1,5.

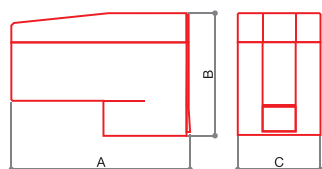
CODICE	MISURA	A	B	C	D	E	F	G	H	L			
69011717	230 V	90	65	44	-	-	-	-	-	-	208	1	-

**SM 1348**

Servomotore modulante 0-10 V con alimentazione 24 V e con attacco M30x1,5.

CODICE	MISURA	A	B	C	D	E	F	G	H	L			
69011719	24 V 0-10V	90	65	44	-	-	-	-	-	-	163	1	-

AZIONATORE PER LA REGOLAZIONE TEMPERATURA AMBIENTE



Chi realizza impianti di riscaldamento, ventilazione e raffreddamento richiede una tecnologia economica e allo stato dell'arte per garantire la sicurezza dei progetti sviluppati. Gli azionatori TE 3020 di Luxor, con "Diretto Controllo Digitale" per tensioni di esercizio da 0 a 10 Volt, presentano le seguenti vantaggiose caratteristiche:

- **modulanti:** regolazione continua e permanente con azionamenti da 0 a 10 Volt;
- **calibrazione automatica:** autoregolazione con rilevamento del punto 0 per la compensazione della tolleranza;
- **facilità di manutenzione:** indicatore di osservazione;
- **silenziosi:** principio termoelettrico;
- **lunga vita operativa:** resistenti all'usura, non richiedono manutenzione e garantiscono la sicurezza operativa;
- **economici:** ottimo rapporto prestazioni/prezzo.

CARATTERISTICHE TECNICHE

Tipo: normalmente chiuso
 Tensione di alimentazione: 24V AC, -10%...+20%, 50-60 Hz
 Max corrente di spunto: <320 mA durante 2 min. max.
 Potenza di esercizio: 1 W
 Tensione di controllo: 0-10 V DC
 Resistenza di ingresso: 100 k Ω
 Corsa di lavoro: 4 mm (minus 0.5 mm over-elevation)
 Forza di spinta: 100 N +5%
 Temperatura fluido: 0÷100 °C
 Temperatura di stoccaggio: -25÷60 °C
 Temperature ambiente: 0÷60 °C
 Grado di protezione: IP 54
 Classe di protezione: III
 Conformità CE secondo: EN 60730
 Materiale: Poliammide bianco
 Cavi di alimentazione: 3x0.22 mm² PVC
 Lunghezza cavi alimentazione: 1 m

CURVE CARATTERISTICHE

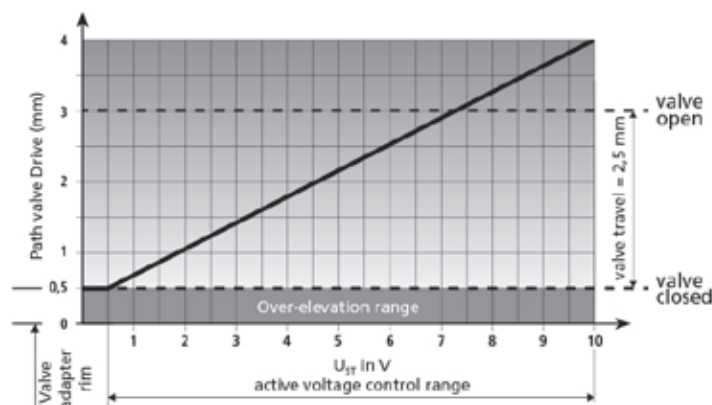

ISTRUZIONI OPERATIVE

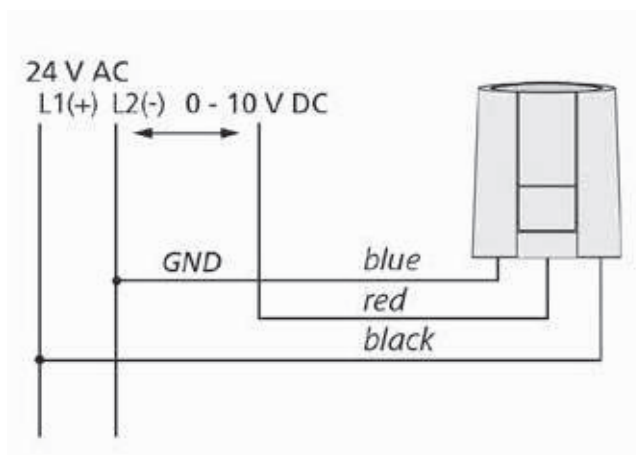

Montati su valvole di controllo, gli azionatori TE 3020 eseguono come elementi di regolazione modulanti (continui) molteplici compiti di azionamento e regolazione.

L'azionamento da 0 a 10 Volt è trasformato proporzionalmente in una corsa da 0 a 4 mm.

Il riscaldamento elettrico dell'elemento di lavoro a cera è rego-

lato dall'elettronica integrata. In base alla tensione di esercizio applicata, la valvola si apre silenziosamente mediante il sollevamento dell'elemento di lavoro a cera. L'azionatore TE 3020 raggiunge la sua corsa massima con tensioni di esercizio superiori a 10 Volt.

INSTALLAZIONE CON L'ADATTATORE



1. Avvitare manualmente l'adattatore della valvola sulla valvola stessa.



2. Collegare il cavo di alimentazione all'attuatore.



3. Posizionare manualmente l'attuatore in posizione verticale sull'adattatore della valvola.



4. Agganciare l'attuatore all'adattatore della valvola applicando manualmente la pressione verticale finché non si sente un click.

Gli attuatori TE 3020 sono dotati del funzionamento "first open", ossia l'attuatore al momento della consegna si trova nello stato normalmente aperto. Questo permette di effettuare il lavaggio e il riempimento dell'impianto a testine già montate, anche prima dei cablaggi elettrici. Nella messa in funzione che segue, l'applicazione di tensione di esercizio (per più di 6 minuti) provoca lo scatto automatico del funzionamento "first open" e l'attuatore è così pronto per il funzionamento.

POSIZIONE DI INSTALLAZIONE



VERTICALE



ORIZZONTALE



CAPOVOLTO

L'attuatore può essere installato in qualsiasi posizione, tuttavia le posizioni consigliate sono la verticale e orizzontale.

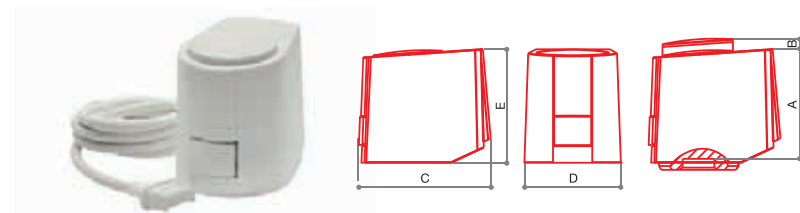

La posizione "capovolto" in alcune circostanze, es. gocciolamento, potrebbero ridurre la durata del dispositivo

AZIONATORE PER LA REGOLAZIONE TEMPERATURA AMBIENTE



TE 3020

Azionatore per la regolazione temperatura ambiente.
Testa termoelettrica 0-10 Volt.

CODICE	MISURA	A	B	C	D	E	F	G	H	L			
69011420	M30x1,5	51.1	7	61.5	44.3	53	-	-	-	-	150	1	-



LUXOR®

6 / SISTEMA IDRONICO MODULARE

SISTEMA IDRONICO MODULARE



Il Sistema Idronico Modulare è composto da:

- un collettore modulare di distribuzione;
- gruppi di rilancio;
- gruppi di miscelazione e rilancio a punto fisso;
- gruppi di miscelazione e rilancio a temperatura scorrevole.

Il Sistema Idronico Modulare SIM 1208 è impiegato nella distribuzione e gestione di impianti a zone. È stato progettato per creare una serie di soluzioni volte a semplificare e risolvere diverse problematiche impiantistiche. Tutti i componenti del gruppo a contatto con l'acqua sono in ottone o in acciaio inox e le guarnizioni in EPDM perossidico. L'utilizzo di questi metalli permette di evitare la corrosione bimetallica, che si manifesta con metalli di diversa nobiltà.

Il collettore può essere allacciato alla caldaia da qualunque direzione: da sinistra, da destra, da sopra oppure da sotto. In questo modo è possibile collegare contemporaneamente più fonti di energia, come una caldaia e un gruppo frigo. Tutto il sistema è facilmente assemblabile in cantiere. Il collettore è modulare, in questo modo lo si può comporre con il numero di moduli necessario all'impianto. Ogni modulo del collettore può essere assemblato in modo da avere gli attacchi dei gruppi da destra oppure da sinistra, adeguando il sistema agli impianti già realizzati.

Sugli attacchi liberi del collettore è possibile installare: termomanometri, valvole di sfogo aria e valvole di carico/scarico acqua, vasi d'espansione e gruppi di sicurezza.

Ogni gruppo di rilancio e miscelazione è installabile con gli attacchi destri oppure sinistri. Ogni gruppo di rilancio e/o miscelazione è provvisto di termometri per la lettura delle temperature di mandata e ritorno, di valvola di bypass differenziale per la pompa installata sui gruppi, di sedi per sonde di regolazione e lettura. I gruppi di miscelazione possono essere collegati direttamente alla caldaia (senza collettore) e fungere da gruppo di rilancio e miscelazione.

I gruppi di miscelazione sono dotati di valvola miscelatrice a pistone a 3 vie, predisposta per la regolazione a punto fisso o scorrevole. La valvola miscelatrice è dotata anche di 2 bypass, uno prima e uno dopo la miscelazione. I gruppi di miscelazione sono dotati di un termostato di sicurezza con sonda e pozzetto ad immersione. Il SIM 1208 è installabile in cassetta metallica e/o a muro per mezzo delle apposite staffe in metallo.

Il SIM 1208 è estremamente compatto in tutte le dimensioni. In 700 mm di larghezza si possono installare fino a 5 gruppi da G 1"1/4; se l'allaccio della caldaia avviene su un lato, i gruppi possono diventare 6. Con le pompe posizionate in orizzontale, la profondità del gruppo è di soli 100 mm.

CARATTERISTICHE TECNICHE

Pressione massima di esercizio 6 bar
Temperatura massima di esercizio 80 °C
Kvs miscelatrice 5,5 (ricircolo) - 6,9 (scambio primario)

CARATTERISTICHE COSTRUTTIVE

Collettore

Materiale collettore:
Ottone CB 753 S UNI EN 1982-2000 per rubinetteria
Materiale kit di collegamento moduli:
CW614N UNI EN 12164:2016
Materiale guarnizioni:
EPDM perossidico

Miscelatrice

Materiale corpo flussimetro:
Ottone CB 753 S UNI EN 1982-2000 per rubinetteria
Materiale guarnizioni:
EPDM perossidico
Componenti in ottone del vitone:
CW614N UNI EN 12164:2016
Componenti in acciaio del vitone:
Acciaio inox

Gruppo portasonde

Materiale corpo:
Ottone CB 753 S UNI EN 1982-2000 per rubinetteria
Materiale componenti:
CW614N UNI EN 12164:2016
Portata massima consigliata sulla miscelatrice 2.750 l/h
(Δp 0,25bar)
Range termometro 0 ÷ 80 °C

Termometri

Cassa e gambo termometro: Acciaio zincato
Copertura: Materiale plastico trasparente
Elemento termometrico: molla a spirale bimetallica

Pompe

Wilo Yonos Para RS 25/6-130-FSM-RKA-12
Wilo Stratos Para 25/1-7-130 T3
Wilo Stratos Para 25/1-8-180 T3

TRATTAMENTI GALVANICI

Finitura nichelata

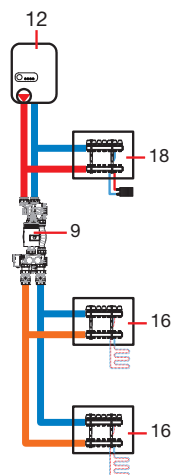
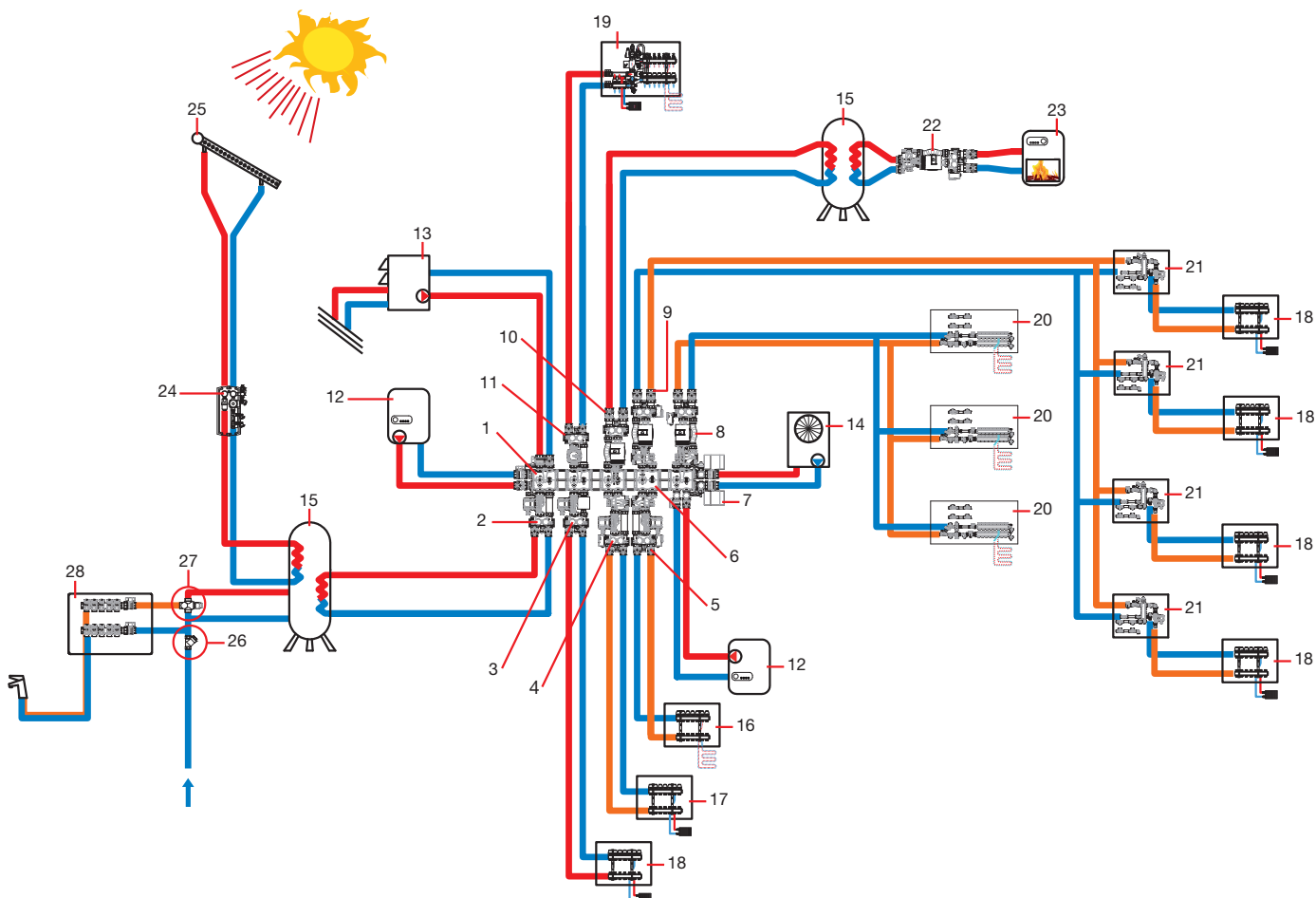

- 1 Collettore CD 1210
- 2 Gruppo di rilancio G 1" GR 1220-GR 1230
- 3 Gruppo di rilancio G 1" GR 1220-GR 1230, con contattorie da G 3/4 interasse 110 mm
- 4 Gruppo di miscelazione G 1" installato con mandata a sx GM 1260-GM 1270
- 5 Gruppo di miscelazione G 1" installato con mandata a dx GM 1260-GM 1270
- 6 Modulo del collettore CD 1210 assemblato rovescio per inversione attacchi del gruppo di rilancio/miscelazione (mandata dx)
- 7 Valvola di zona VZ 700
- 8 Gruppo di miscelazione G 1"1/4 installato con mandata a dx GM 1260 - GM 1270
- 9 Gruppo di miscelazione G 1"1/4 installato con mandata a sx GM 1260 - GM 1270
- 10 Gruppo di rilancio G 1"1/4 GR 1220 - GR 1230
- 11 Gruppo di rilancio G 1" GR 1220 - GR 1230
- 12 Caldaia
- 13 Pompa di calore
- 14 Gruppo frigo
- 15 Bollitore
- 16 Collettore CD 2468 per la distribuzione in un impianto a pannelli radianti
- 17 Collettore CD 2468 per la distribuzione in un impianto con Fan Coil
- 18 Collettore CD 2468 per la distribuzione in un impianto con radiatori
- 19 Gruppo premontato CCBAP 4037 completo di distribuzione per alta temperatura, miscelazione a punto fisso e rilancio
- 20 Gruppo premontato MC 5001 con predisposizione per la contabilizzazione riscaldamento /sanitario, valvola deviatrice e collettori di distribuzione
- 21 Gruppo premontato MC 5003 con predisposizione per la contabilizzazione riscaldamento /sanitario, separatore idraulico e pompa di rilancio
- 22 Gruppo di miscelazione G 1"1/4 con punto fisso per ricircolo delle caldaie a combustibile solido
- 23 Caldaia a combustibile solido
- 24 Gruppo di circolazione per pannelli solari GSP 1180
- 25 Pannello solare termico
- 26 Filtro RF 5008
- 27 Miscelazione sanitaria VM 660
- 28 Collettori sanitari

DISEGNO DIMENSIONALE

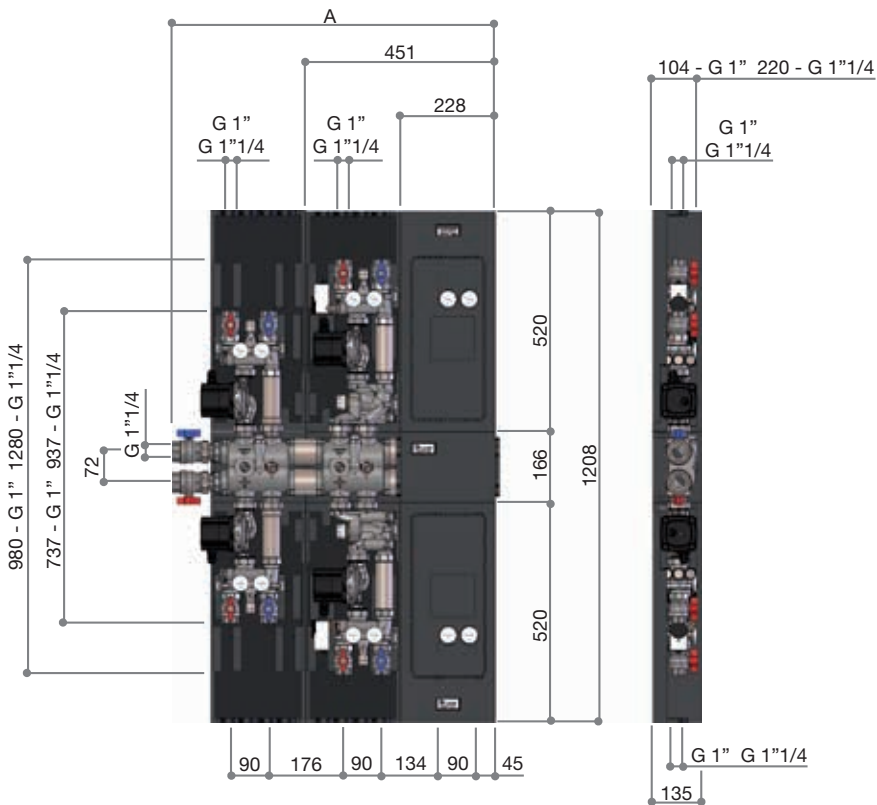
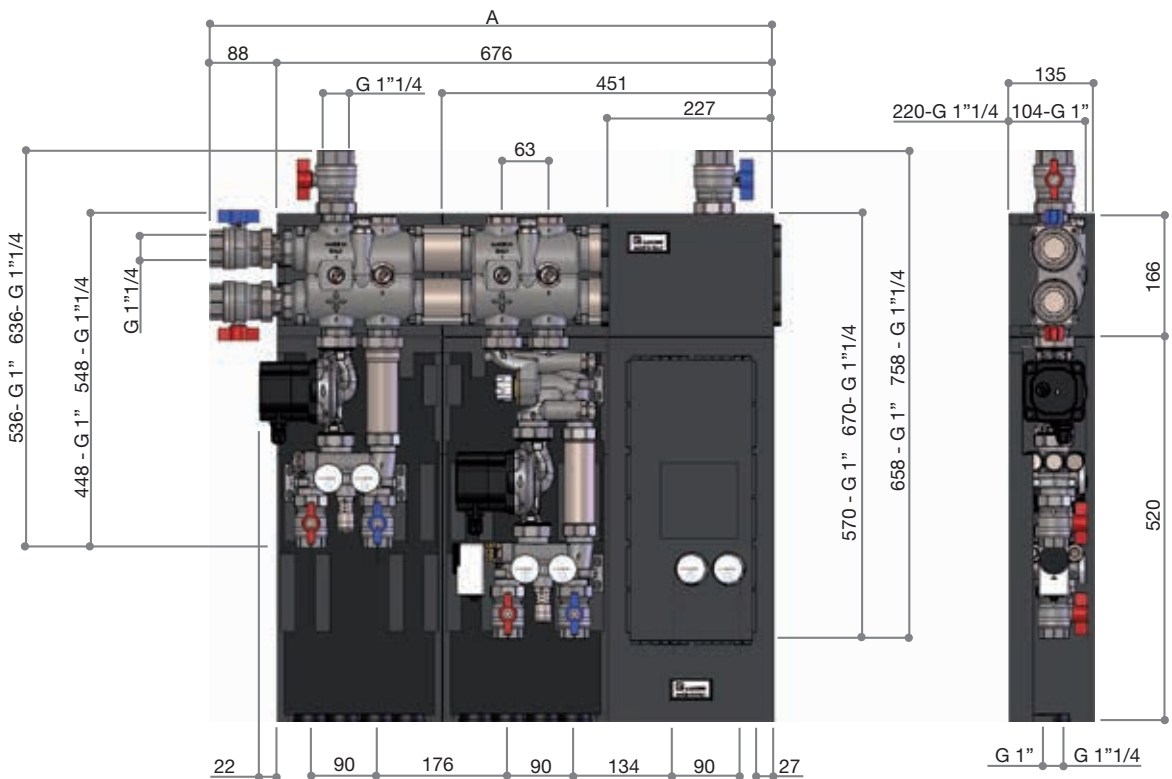

COLLETTORI

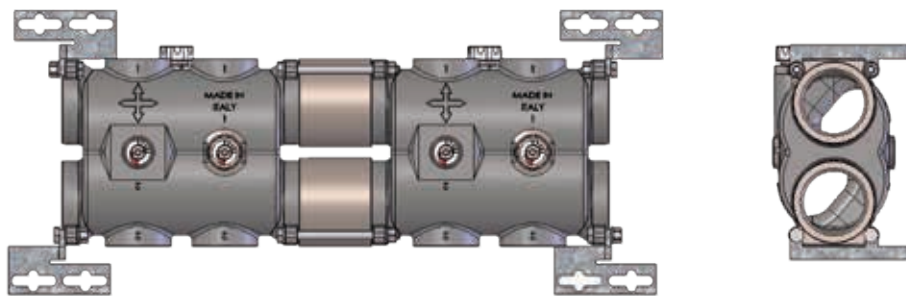

Collettore modulare da G 1" 1/2, con attacchi per i gruppi da G 1" 1/4 e valvole di bypass e bilanciamento.

Possibilità di aprire il bypass installato su tutti i moduli, in modo da funzionare anche come separatore idraulico.

Passaggio interno libero Ø 45 mm

Attacchi al circuito primario da G 1"1/2.

Attacchi ai gruppi di rilancio e miscelazione da G 1"1/4.

DISEGNO DI FLUSSO

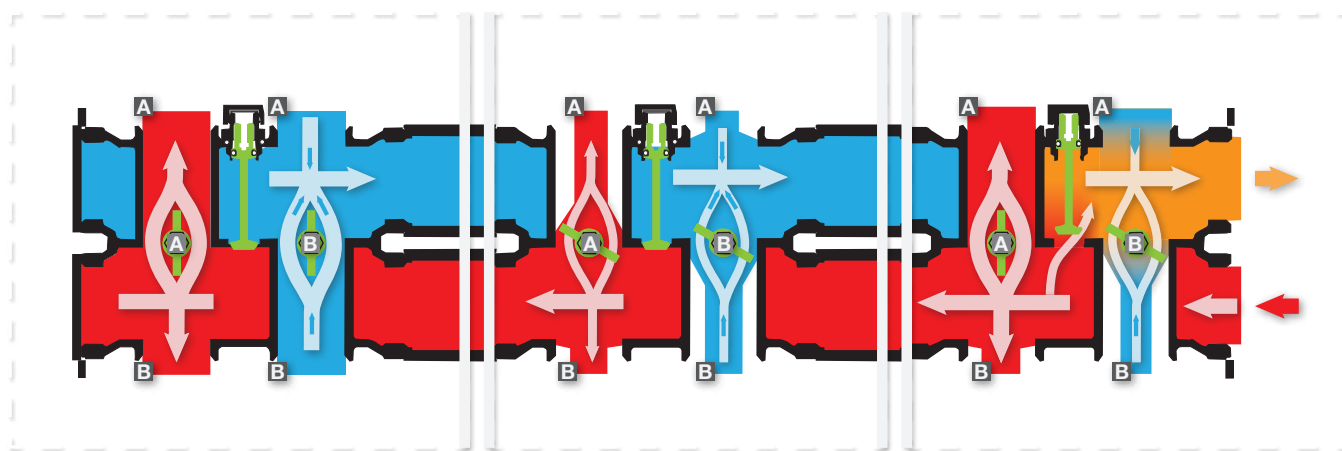

Modulo collettore con:

- A. Valvola di bilanciamento tutta aperta
- B. Valvola di bilanciamento tutta aperta

Modulo collettore con:

- A. Valvola di bilanciamento parzialmente aperta
- B. Valvola di bilanciamento parzialmente aperta

Modulo collettore con:

- A. Valvola di bilanciamento tutta aperta
- B. Valvola di bilanciamento parzialmente aperta

CARATTERISTICHE IDRAULICHE DEL COLLETTORE CD 1210

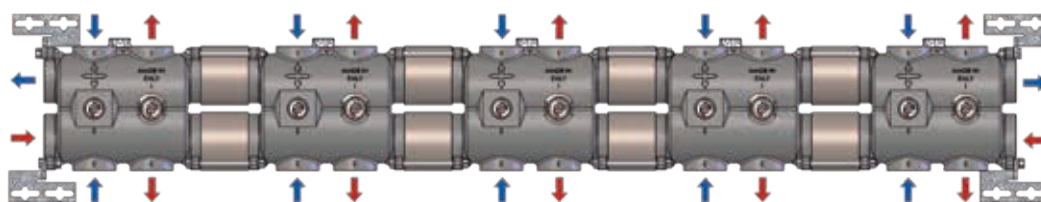

Il collettore CD 1210, se assemblato tutto nello stesso verso, ha un funzionamento idraulico uguale a quello di un classico collettore complanare con gli attacchi alternati su entrambi i lati del collettore e attacchi principali di testa da G 1"1/2.

Se necessario, è possibile assemblare il collettore in modo da invertire le uscite. Nell'immagine seguente, il terzo e il quarto modulo sono invertiti.

L'inversione si ottiene ruotando il modulo del collettore di 180°. Gli ingressi di testa sul collettore e su tutti gli altri moduli rimarranno invariati.

Questa possibilità è molto utile nel caso si debbano adeguare gli attacchi del collettore ad impianti preesistenti.



DIAGRAMMA DI PORTATA COLLETTORI



Kvs	N. VIE	POS
25	2	1
24	3	2
23	4	3
21	5	4

PROSPETTO VALORI KV BYPASS E VALVOLA DI BILANCIAMENTO

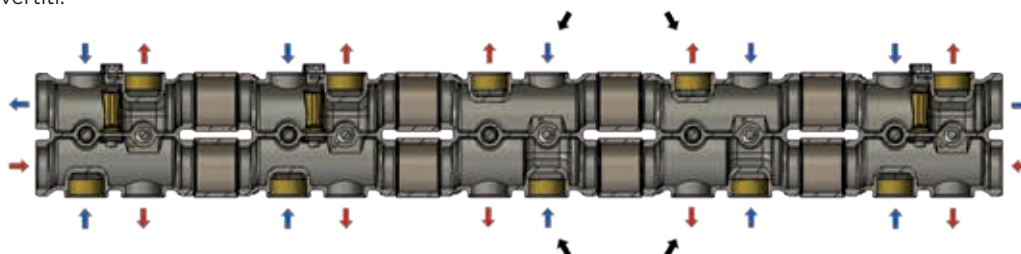
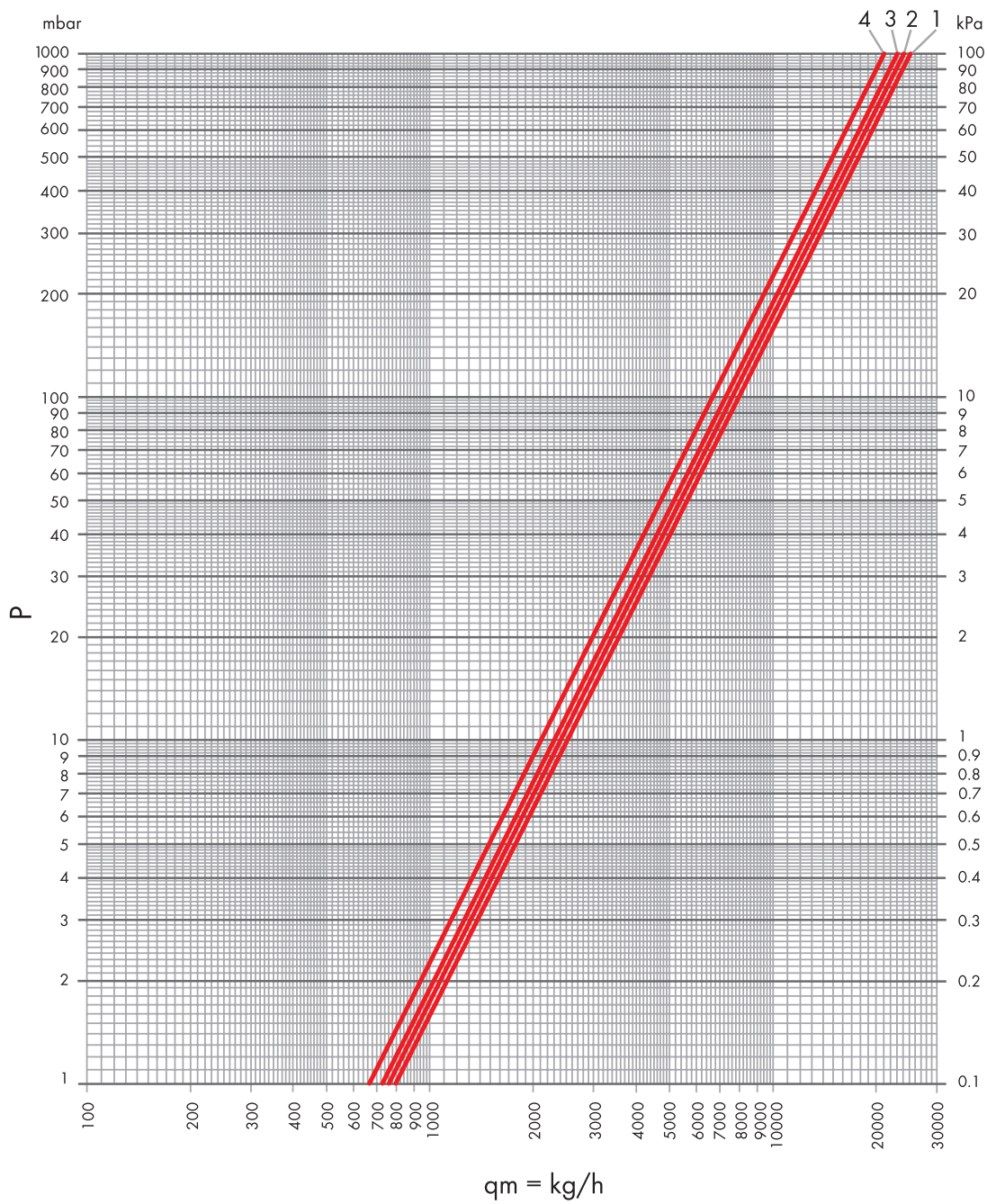
BYPASS

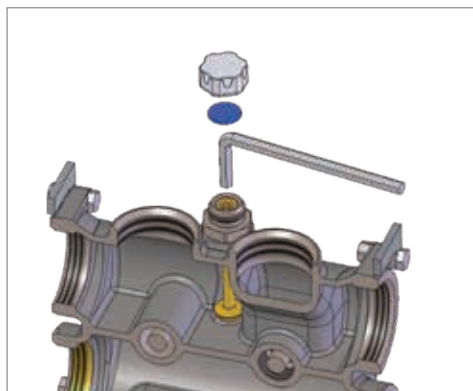

N.GIRI DELLA CHIUSURA	Kv
1/4	0,17
1/2	0,51
1	1,27
1"1/2	1,87
2	2,55
2"1/2	3,05

N.GIRI DELLA CHIUSURA	Kv
3	3,56
3"1/2	3,82
4	3,99
4"1/2	4,16
Tutto aperto	4,33

Aprendo il Bypass presente su ciascun modulo, è possibile avere un collettore che fa anche da separatore idraulico.

Soluzione molto comoda in presenza di più generatori di calore e/o circuiti primari.

VALVOLA DI BILANCIAMENTO

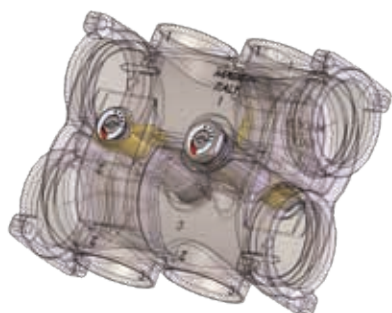

POSIZIONE INDICE ASTA	Kv
0	5,43
1	6,79
3	8,13
5	8,51
7	8,72

La regolazione della valvola di bilanciamento diventa estremamente comoda (in alcuni casi fondamentale) quando un collettore serve molti gruppi.

Infatti i gruppi sono tutti collegati in parallelo. In presenza di un gruppo sfavorito, le valvole di bilanciamento permettono di correggere la situazione bilanciando i circuiti e avendo così la certezza del corretto funzionamento dell'impianto.

ATTENZIONE

Ogni modulo del collettore ha 2 valvole di bilanciamento. Le valvole possono essere regolate da entrambi i lati del collettore.

Ogni valvola regola il Kv di una coppia di attacchi da G 1"1/4. Le valvole e gli attacchi corrispondenti sono controassegnati con un numero identificativo "1" e "2".

DISEGNO DIMENSIONALE COLLETTORE MODULARE

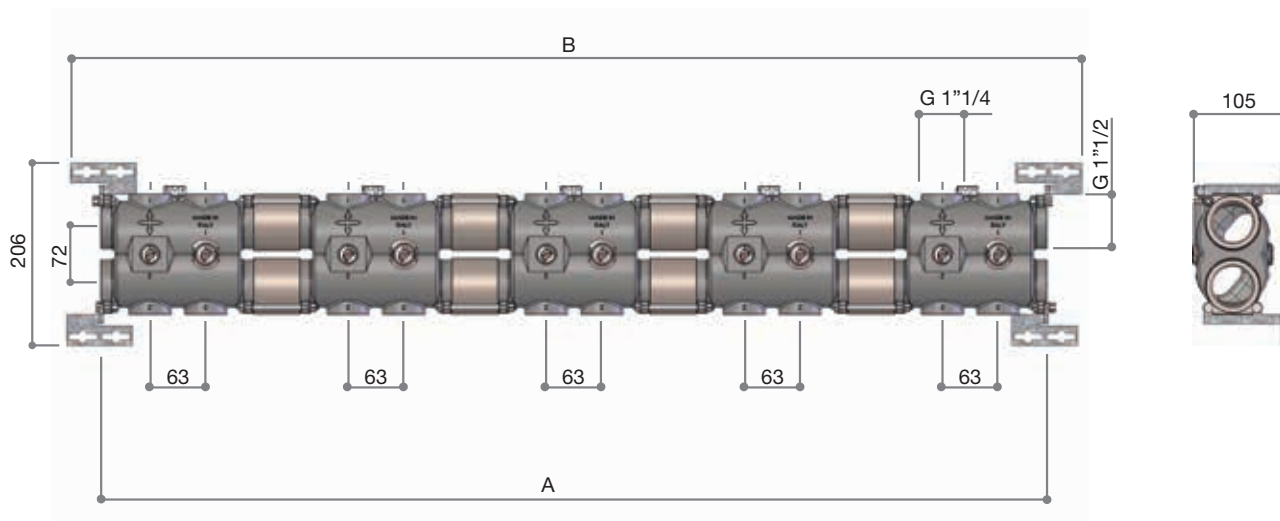

CD 1210

CODICE	N. ATTACCHI	A	B	C	D	E	F	G	H	L	M	N	P	R
68744251	1+1	174	267	-	-	-	-	-	-	-	-	-	-	-
68744252	2+2	398	471	-	-	-	-	-	-	-	-	-	-	-
68744253	3+3	622	695	-	-	-	-	-	-	-	-	-	-	-
68744254	4+4	846	919	-	-	-	-	-	-	-	-	-	-	-
68744255	5+5	1070	1143	-	-	-	-	-	-	-	-	-	-	-



CD 1210

Collettore modulare da G 1 1/2, con attacchi per i gruppi da G 1 1/4 e valvole di bypass e bilanciamento. Possibilità di aprire il bypass installato su tutti i moduli, in modo da funzionare anche come separatore idraulico. Passaggio interno libero \varnothing 45mm. (la versione CB è coibentata).

CODICE	N. ATTACCHI	MISURA			
68744251	1+1	G 1 1/2 x G 1 1/4	3,884	1	-
68744251CB	1+1		3,964	1	-
68744252	2+2		8,226	1	-
68744252CB	2+2		8,386	1	-
68744253	3+3		12,568	1	-
68744253CB	3+3		12,808	1	-
68744254	4+4		16,910	1	-
68744254CB	4+4		17,230	1	-
68744255	5+5		21,252	1	-
68744255CB	5+5		21,652	1	-

GRUPPO DI RILANCIO

DISEGNO DIMENSIONALE

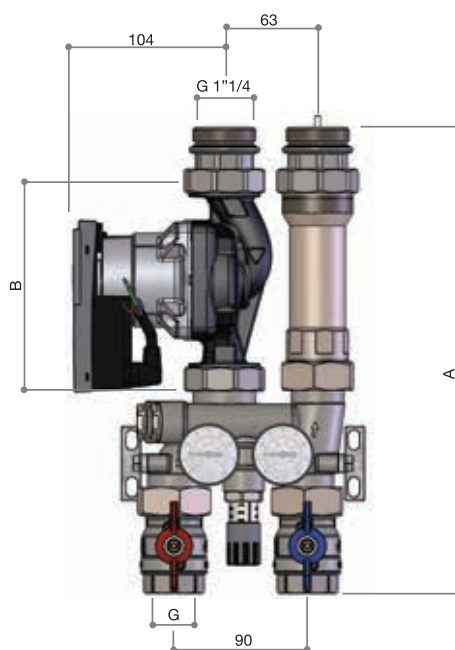
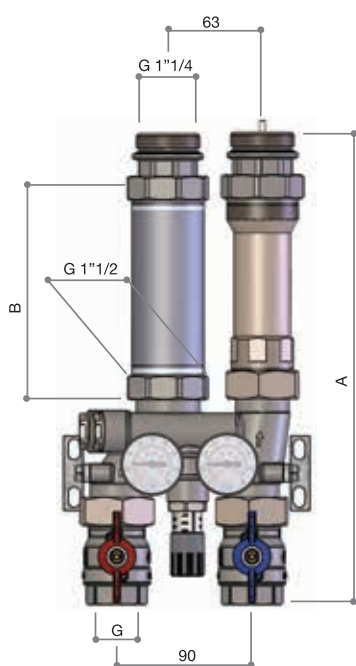

GR 1220

CODICE	MISURA	A	B	C	D	E	F	G
68763400	G 1"	315	130	-	-	-	-	G 1"
68764200	G 1 1/4"	415	180	-	-	-	-	G 1 1/4"

GR 1230

CODICE	MISURA	A	B	C	D	E	F	G
68763410	G 1"	315	130	-	-	-	-	G 1"
68764210	G 1 1/4"	415	180	-	-	-	-	G 1 1/4"

SCHEMA IDRAULICO

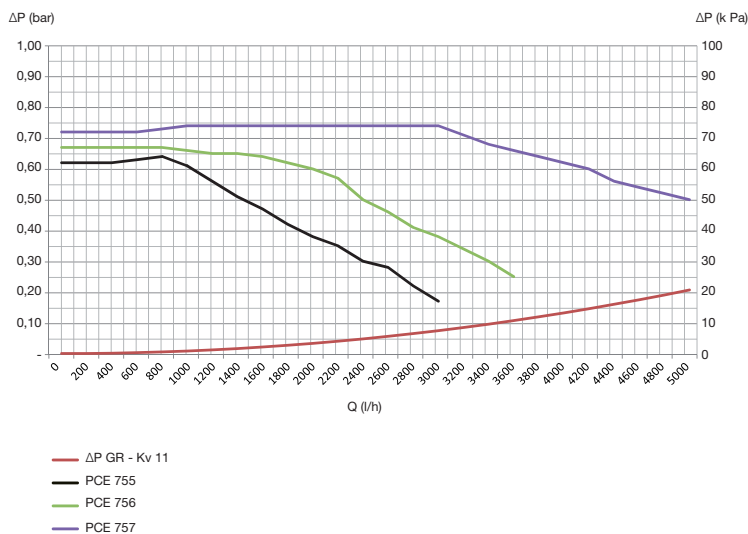
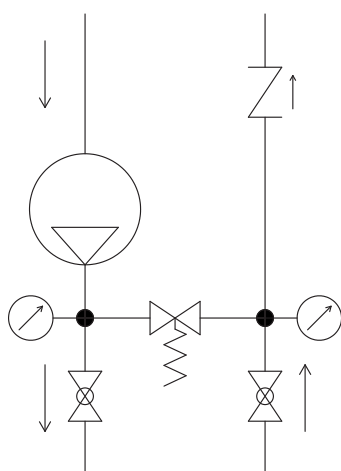

Per evitare eccessive rumorosità dell'impianto, evitare l'impiego con valori di ΔP superiori a 0,2-0,25 bar.

GRUPPO DI RILANCIO

**GR 1220**

Gruppo di rilancio senza pompa.
Portata massima consigliata 3.000 l/h.

Ogni gruppo è provvisto di:

- termometri per la visualizzazione delle temperature di mandata e ritorno;
- valvola di Bypass differenziale;
- valvola unidirezionale;
- valvole a sfera per l'intercettazione dei circuiti.

(la versione CB è coibentata).

CODICE	MISURA	INTERASSE			
68763400	G 1"	130 mm	4,474	1	-
68763400CB	G 1"	130 mm	4,754	1	-
68764201	G 1"	180 mm	4,922	1	-
68764200	G 1"1/4	180 mm	5,474	1	-
68764200CB	G 1"1/4	180 mm	5,754	1	-

**GR 1230**

Gruppo di rilancio con pompa.
Portata massima consigliata 3.000 l/h.

Ogni gruppo è provvisto di:

- termometri per la visualizzazione delle temperature di mandata e ritorno;
- valvola di bypass differenziale;
- valvola unidirezionale;
- valvole a sfera per l'intercettazione dei circuiti.

(la versione CB è coibentata).

CODICE	MISURA	INTERASSE			
68763410	G 1"	130 mm	5,582	1	-
68763410CB	G 1"	130 mm	5,862	1	-
68764210	G 1"1/4	180 mm	8,092	1	-
68764210CB	G 1"1/4	180 mm	8,372	1	-

GRUPPO A PUNTO FISSO

DISEGNO DIMENSIONALE

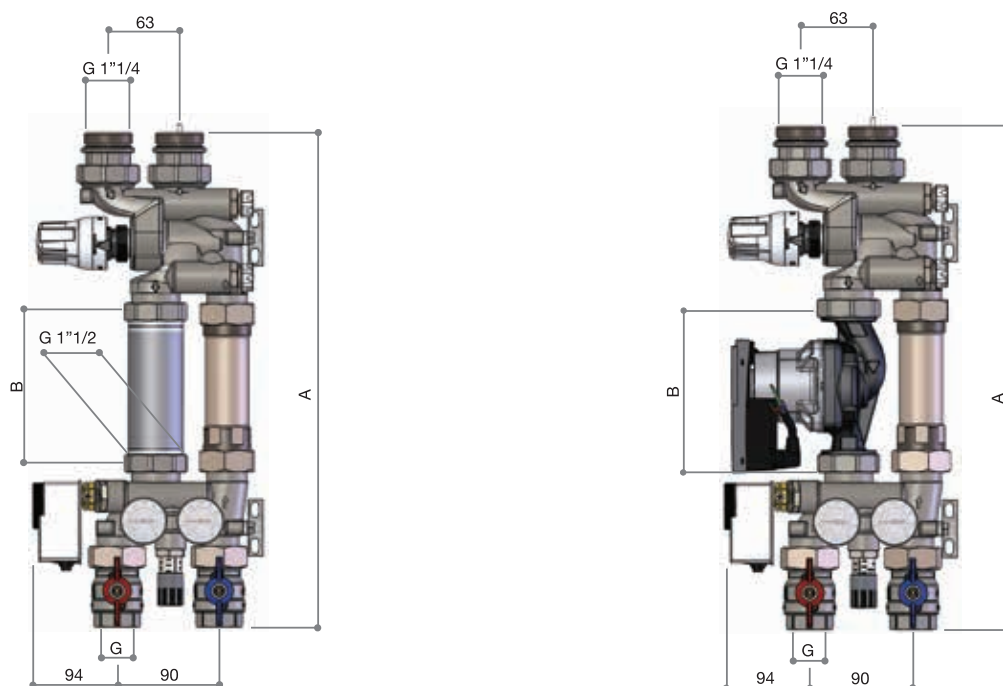

GM 1240

CODICE	MISURA	A	B	C	D	E	F	G
68763420	G 1"	437	130	-	-	-	-	G 1"
68764220	G 1"1/4	537	180	-	-	-	-	G 1"1/4

GM 1250

CODICE	MISURA	A	B	C	D	E	F	G
68763430	G 1"	437	130	-	-	-	-	G 1"
68764230	G 1"1/4	537	180	-	-	-	-	G 1"1/4

SCHEMA IDRAULICO

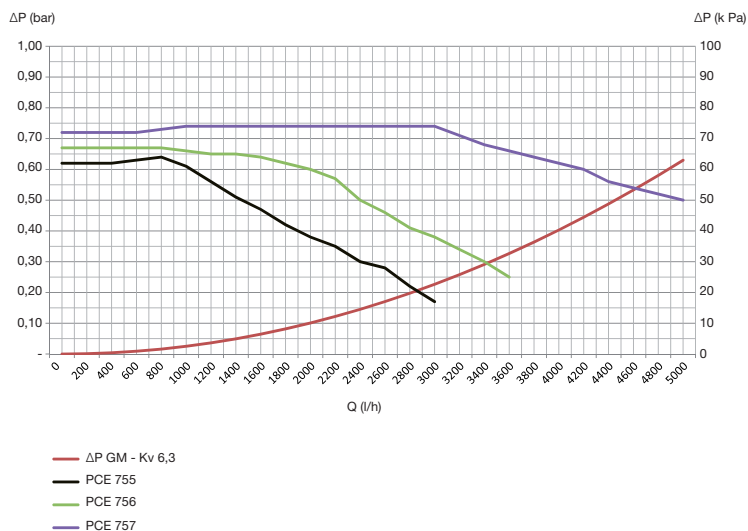
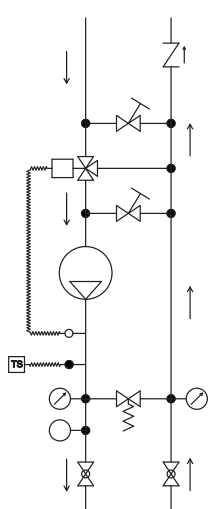

Per evitare eccessive rumorosità dell'impianto, evitare l'impiego con valori di ΔP superiori a 0,2-0,25 bar.



GRUPPO A PUNTO FISSO

**GM 1240**

Gruppo a punto fisso senza pompa.
Portata massima consigliata 2.750 l/h.
Ogni gruppo è provvisto di:

- valvola miscelatrice a pistone a 3 vie;
- testa termostatica di regolazione per punto fisso;
- valvole di bypass con regolazione manuale per i circuiti prima e dopo la miscelatrice;
- termometri per la visualizzazione delle temperature di mandata e ritorno;
- valvola di bypass differenziale;
- valvola unidirezionale;
- valvole a sfera per l'intercettazione dei circuiti.

(la versione CB è coibentata).



CODICE	MISURA	INTERASSE			
68763420	G 1"	130 mm	4,946	1	-
68763420CB	G 1"	130 mm	5,226	1	-
68764220	G 1"1/4	180 mm	5,827	1	-
68764220CB	G 1"1/4	180 mm	6,107	1	-

**GM 1250**

Gruppo a punto fisso con pompa.
Portata massima consigliata 2.750 l/h.
Ogni gruppo è provvisto di:

- valvola miscelatrice a pistone a 3 vie;
- testa termostatica di regolazione per punto fisso;
- valvole di bypass con regolazione manuale per i circuiti prima e dopo la miscelatrice;
- termometri per la visualizzazione delle temperature di mandata e ritorno;
- valvola di bypass differenziale;
- valvola unidirezionale;
- valvole a sfera per l'intercettazione dei circuiti.

(la versione CB è coibentata).

CODICE	MISURA	INTERASSE			
68763430	G 1"	130 mm	6,054	1	-
68763430CB	G 1"	130 mm	6,334	1	-
68764230	G 1"1/4	180 mm	8,445	1	-
68764230CB	G 1"1/4	180 mm	8,725	1	-

GRUPPO A PUNTO SCORREVOLE

DISEGNO DIMENSIONALE

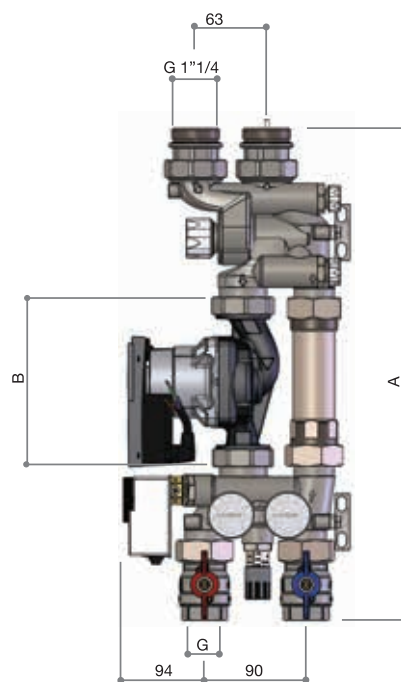
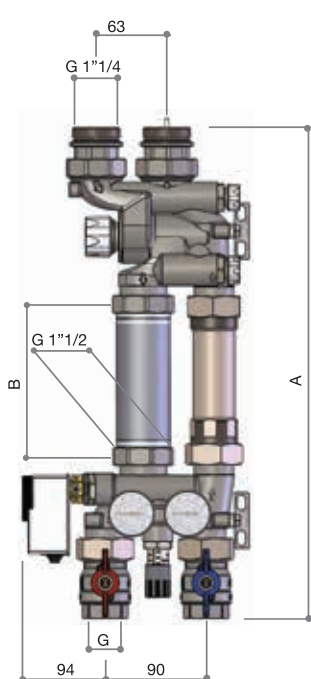

GM 1260

CODICE	MISURA	A	B	C	D	E	F	G
68763440	G 1"	437	130	-	-	-	-	G 1"
68764240	G 1 1/4"	537	180	-	-	-	-	G 1 1/4"

GM 1270

CODICE	MISURA	A	B	C	D	E	F	G
68763450	G 1"	437	130	-	-	-	-	G 1"
68764250	G 1 1/4"	537	180	-	-	-	-	G 1 1/4"

SCHEMA IDRAULICO

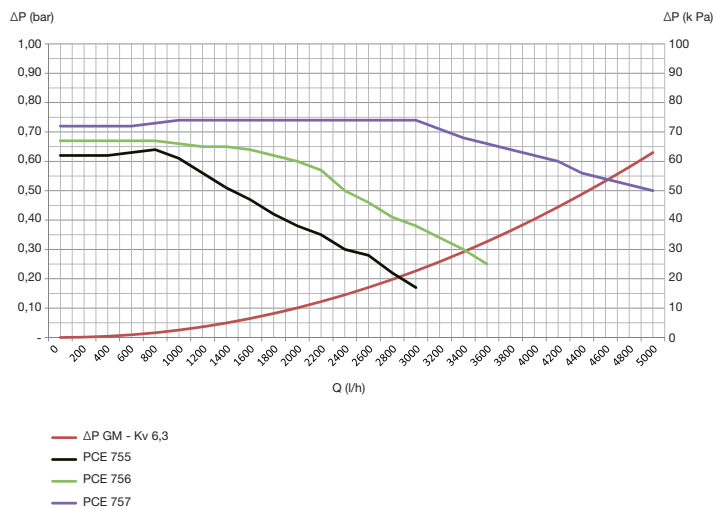
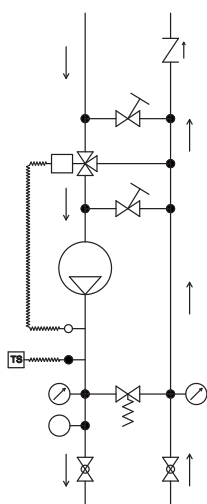

Per evitare eccessive rumorosità dell'impianto, evitare l'impiego con valori di ΔP superiori a 0,2-0,25 bar.

GRUPPO A PUNTO SCORREVOLE

**GM 1260**

Gruppo a punto scorrevole senza pompa.
Portata massima consigliata 2.750 l/h.

Ogni gruppo è provvisto di:

- valvola miscelatrice a pistone a 3 vie;
- possibilità di installare un motore 3 punti oppure 0-10 V, su un vitone con attacco standard M30x1,5 mm;
- valvole di bypass con regolazione manuale per i circuiti prima e dopo la miscelatrice;
- termometri per la visualizzazione delle temperature di mandata e ritorno;
- valvola di bypass differenziale;
- valvola unidirezionale;
- valvole a sfera per l'intercettazione dei circuiti.

(la versione CB è coibentata).

CODICE	MISURA	INTERASSE			
68763440	G 1"	130 mm	4,800	1	-
68763440CB	G 1"	130 mm	5,080	1	-
68764241	G 1"	180 mm	5,129	1	-
68764240	G 1"1/4	180 mm	5,681	1	-
68764240CB	G 1"1/4	180 mm	5,961	1	-



**GM 1270**

Gruppo a punto scorrevole con pompa.
Portata massima consigliata 2.750 l/h.

Ogni gruppo è provvisto di:

- valvola miscelatrice a pistone a 3 vie;
- possibilità di installare un motore 3 punti oppure 0-10 V, su un vitone con attacco standard M30x1,5 mm;
- valvole di bypass con regolazione manuale per i circuiti prima e dopo la miscelatrice;
- termometri per la visualizzazione delle temperature di mandata e ritorno;
- valvola di bypass differenziale;
- valvola unidirezionale;
- valvole a sfera per l'intercettazione dei circuiti.

(la versione CB è coibentata).

CODICE	MISURA	INTERASSE			
68763450	G 1"	130 mm	5,908	1	-
68763450CB	G 1"	130 mm	6,188	1	-
68764250	G 1"1/4	180 mm	8,299	1	-
68764250CB	G 1"1/4	180 mm	8,579	1	-

POSSIBILI APPLICAZIONI E ASSEMBLAGGI

GR 1220 - GR 1230

Utilizzabile per il collegamento ad una fonte di calore esterna oppure come gruppo di rilancio.

GM 1260 - GM 1270

Utilizzabile per impianti di riscaldamento a punto scorrevole.

GM 1260 - GM 1270

Utilizzabile per impianti di riscaldamento a punto scorrevole.

Il collettore può essere collegato al circuito primario sia attraverso gli attacchi laterali da G 1"1/2 sia attraverso gli attacchi superiori e inferiori da G 1"1/4.

Il collettore può essere collegato al circuito primario sia attraverso gli attacchi laterali da G 1"1/2 sia attraverso gli attacchi superiori e inferiori da G 1"1/4.

GR 1220 - GR 1230

Utilizzabile per il collegamento ad una fonte di calore esterna oppure come gruppo di rilancio.

GM 1260 - GM 1270

Utilizzabile per impianti di riscaldamento a punto scorrevole.

Collegando i moduli del collettore in modo opportuno tra loro, è possibile invertire la posizione degli attacchi alle colonne dei gruppi di rilancio e di miscelazione.

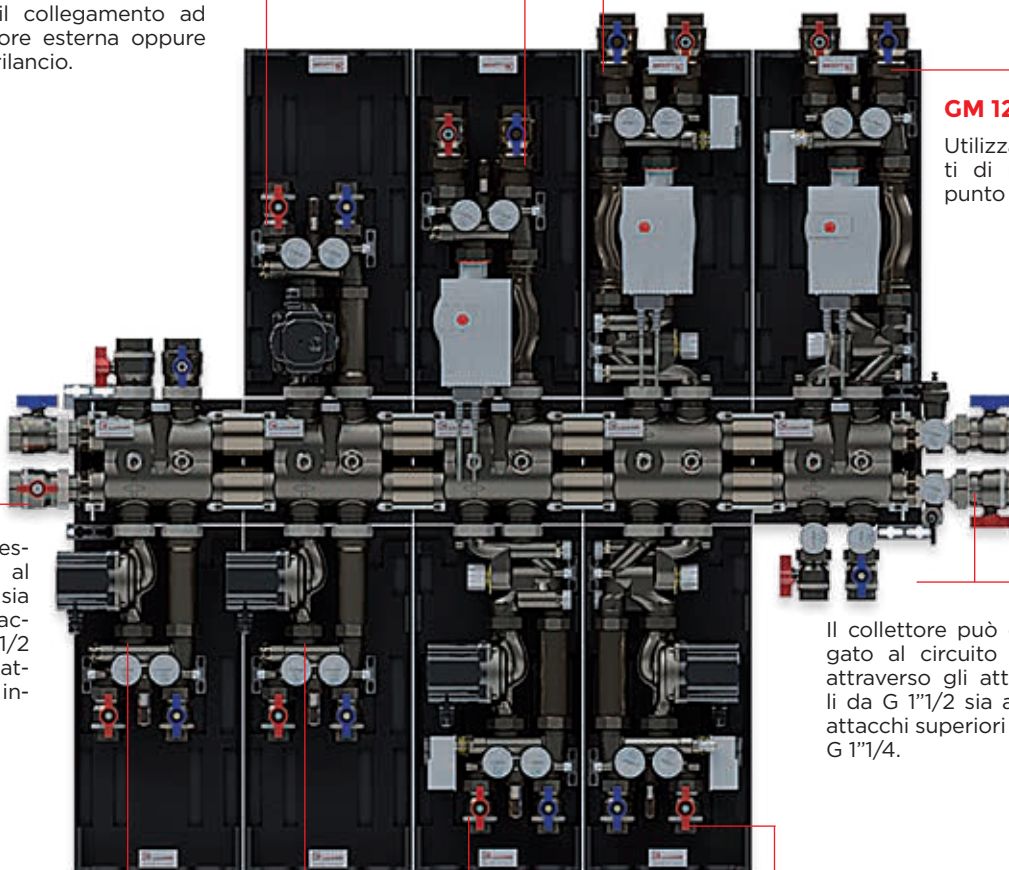

VALVOLA MISCELATRICE VM 1200



Valvola miscelatrice DN 25. Può essere abbinata alla testa termostatica per impianti a punto fisso TT 3051, oppure ad un attuatore che abbia il filetto M30x1,5, con punto di chiusura 11,5 mm e corsa ≥ 3 mm.

Sulla miscelatrice sono installati 2 bypass:

- **Bypass primario.** Consente di creare un ricircolo per la pompa del primario (es. pompa caldaia).
- **Bypass secondario.** Consente di creare un ricircolo per la pompa installata sul gruppo, permettendo di bilanciare la temperatura dei pannelli e creare inerzia termica per il sistema di regolazione della temperatura.

Attacchi al circuito primario da G 1"1/2 maschio.

Attacco alla pompa con dado girevole G 1"1/2 e attacco al tronchetto di ricircolo con dado girevole G 1"1/4.

CARATTERISTICHE TECNICHE

Kvs miscelatrice 5,5 (ricircolo) 6,9 (scambio primario)

Portata massima consigliata sulla miscelatrice 2.750 l/h (Δp 0,25bar - ricircolo)

Massima pressione differenziale consigliata sulla miscelatrice 0,25 bar

CARATTERISTICHE IDRAULICHE

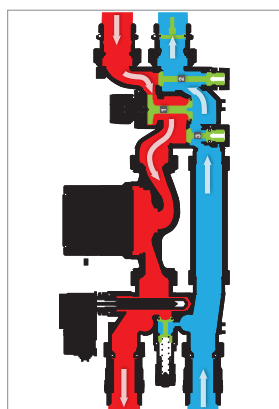

- 1 Miscelatrice tutta aperta
- 2 Bypass primario chiuso
- 3 Bypass secondario chiuso



- 1 Miscelatrice tutta aperta
- 2 Bypass primario aperto
- 3 Bypass secondario aperto

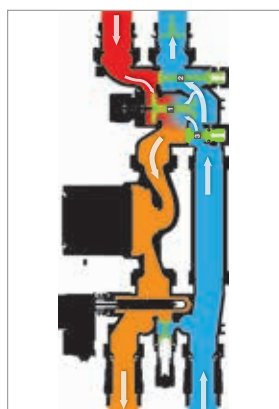

- 1 Miscelatrice parzialmente aperta
- 2 Bypass primario chiuso
- 3 Bypass secondario chiuso



- 1 Miscelatrice parzialmente aperta
- 2 Bypass primario aperto
- 3 Bypass secondario aperto

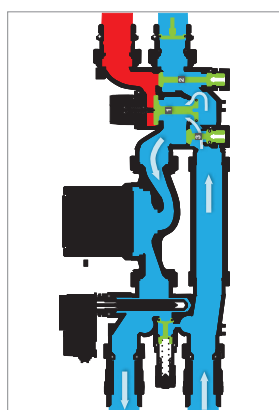

- 1 Miscelatrice chiusa
- 2 Bypass primario chiuso
- 3 Bypass secondario chiuso

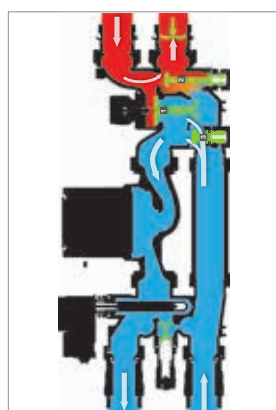

- 1 Miscelatrice chiusa
- 2 Bypass primario aperto
- 3 Bypass secondario aperto

DIAGRAMMA CARATTERISTICO IN FUNZIONE DELLA CORSA DEL VITONE

DIAGRAMMA PRIMARIO/RICIRCOLO CON BYPASS CHIUSO

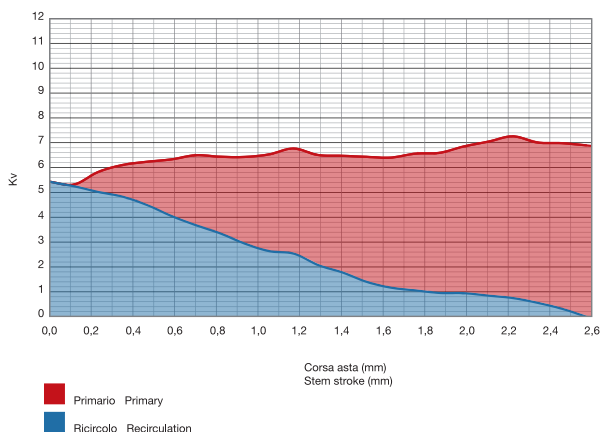

Kv PRIMARIO	Kv RICIRCOLO	CORSA ASTA	% PRIMARIO	% RICIRCOLO
0,00	5,43	chiuso	0%	100%
0,07	5,25	0,1	1%	99%
0,80	5,02	0,2	14%	86%
1,27	4,83	0,4	21%	79%
1,74	4,49	0,5	28%	72%
2,28	4,05	0,6	36%	64%
2,82	3,68	0,7	43%	57%
3,09	3,35	0,8	48%	52%
3,49	2,94	0,9	54%	46%
3,89	2,64	1,1	60%	40%
4,23	2,54	1,2	62%	38%
4,43	2,08	1,3	68%	32%
4,70	1,78	1,4	73%	27%
5,03	1,40	1,5	78%	22%
5,23	1,17	1,6	82%	18%
5,50	1,06	1,8	84%	16%
5,63	0,96	1,9	85%	15%
5,90	0,95	2,0	86%	14%
6,20	0,85	2,1	88%	12%
6,51	0,75	2,2	90%	10%
6,45	0,56	2,3	92%	8%
6,66	0,32	2,5	95%	5%
6,90	0,00	tutto aperto	100%	0%

DIAGRAMMA PRIMARIO/RICIRCOLO CON BYPASS APERTO

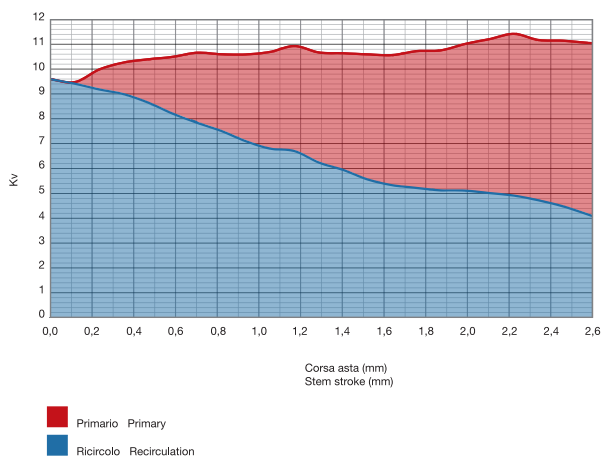

Kv PRIMARIO	Kv RICIRCOLO	CORSA ASTA	% PRIMARIO	% RICIRCOLO
0,00	9,59	chiuso	0%	100%
0,07	9,41	0,1	1%	99%
0,80	9,18	0,2	8%	92%
1,27	8,99	0,4	12%	88%
1,74	8,65	0,5	17%	83%
2,28	8,21	0,6	22%	78%
2,82	7,84	0,7	26%	74%
3,09	7,51	0,8	29%	71%
3,49	7,10	0,9	33%	67%
3,89	6,80	1,1	36%	64%
4,23	6,70	1,2	39%	61%
4,43	6,24	1,3	42%	58%
4,70	5,94	1,4	44%	56%
5,03	5,56	1,5	48%	52%
5,23	5,33	1,6	50%	50%
5,50	5,22	1,8	51%	49%
5,63	5,12	1,9	52%	48%
5,90	5,11	2,0	54%	46%
6,20	5,01	2,1	55%	45%
6,51	4,91	2,2	57%	43%
6,45	4,72	2,3	58%	42%
6,66	4,48	2,5	60%	40%
6,90	4,16	tutto aperto	62%	38%

PROSPETTO VALORI KV BYPASS MISCELATRICE IN FUNZIONE DEL NUMERO DI GIRI DELL'OTTURATORE

BYPASS PRIMARIO		BYPASS SECONDARIO	
N. GIRI DALLA CHIUSURA	Kv	N. GIRI DALLA CHIUSURA	Kv
1/4	0,30	1/4	0,25
1/2	0,64	1/2	0,59
1	1,32	1	1,27
1 1/2	2,04	1 1/2	1,87
2	2,72	2	2,38
2 1/2	3,48	2 1/2	2,97
3	4,07	3	3,22
3 1/2	4,33	3 1/2	3,56
4	4,58	4	3,73
4 1/2	4,67	4 1/2	3,82
tutto aperto	4,67	tutto aperto	4,16

ACCESSORI COLLETTORI DI DISTRIBUZIONE

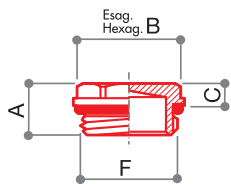

TC 460

Tappo cieco con guarnizione o-ring.

CODICE	MISURA	FINITURA	A	B	C	D	E	F	G	H	L			
68559942N	G 1" 1/4	NICHELATA	25	38	12	-	-	G 1" 1/4	-	-	-	94	30	240
68559948N	G 1" 1/2	NICHELATA	26	48	16	-	-	G 1" 1/2	-	-	-	160	16	128

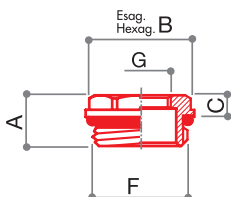

TC 462

Tappo con riduzione e con guarnizione di tenuta o-ring.

CODICE	MISURA	FINITURA	A	B	C	D	E	F	G	H	L			
68559916N	G 1"1/2 x G 1"	NICHELATA	26	48	16	-	-	G 1"1/2	G 1"	-	-	200	16	128
68559915N	G 1"1/2 x G 1"1/4	NICHELATA	26	48	16	-	-	G 1"1/2	G 1"1/4	-	-	124	16	128

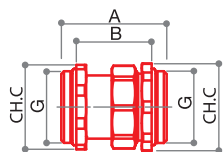

RD 455

Raccordo di unione M-M in tre pezzi con guarnizione o-ring.

CODICE	MISURA	A	B	C	D	E	F	G	H	L			
68994801N	G 1"1/2	70	50	65	-	-	-	G 1"1/2	-	-	460	5	40

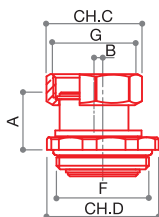

RE 447

Raccordo eccentrico per l'assemblaggio dei gruppi sul collettore CD1210 sul lato attacco caldaia. Da utilizzare in coppia.

CODICE	MISURA	A	B	C	D	E	F	G	H	L			
68994810N	G 1"1/2 M x G 1"1/4F	30	4,5	46	56	-	G 1"1/2	G 1"1/4	-	-	340	5	40

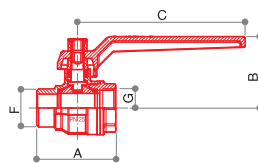

VC 476

Valvola a sfera a passaggio totale, nichelata, senza bocchettone, con leva di colore blu o rossa.

CODICE	MISURA	A	B	C	D	E	F	G	H	L			
68559829B	G 1"1/2	91	75	150	-	-	G 1"1/2	G 1"1/2	-	-	1400	2	16
68559829R	G 1"1/2	91	75	150	-	-	G 1"1/2	G 1"1/2	-	-	1400	2	16

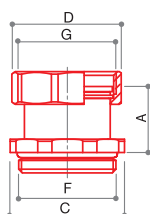

CR 496

Dado e raccordo nichelato con guarnizione per il collegamento della valvola a sfera VC476.

CODICE	MISURA	A	B	C	D	E	F	G	H	L			
67934800	G 1"1/2	32	-	56	52	-	G 1"1/2	G 1"1/2	-	-	280	6	48

COIBENTAZIONE



CB 1220

Coibentazione per modulo collettore CD 1210.

CODICE	MISURA	A	B	C	D	E	F	G	H	L			
72000080	G 1"1/4 x G 1"	243	166	138	223	10	135	-	-	-	80	-	1

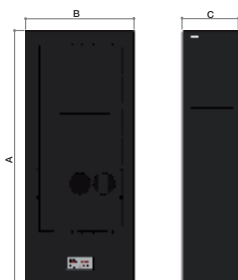

CB 1222

Coibentazione per i gruppi di rilancio e miscelazione.

CODICE	MISURA	A	B	C	D	E	F	G	H	L			
Gruppi di rilancio													
72000082	G 1" - 130 mm	520	223	135	-	-	-	-	-	-	280	-	1
72000084	G 1"1/4 - 180 mm	520	223	135	-	-	-	-	-	-	280	-	1
Gruppi di miscelazione													
72000086	G 1" - 130 mm	520	223	135	-	-	-	-	-	-	280	-	1
72000088	G 1"1/4 - 180 mm	520	223	135	-	-	-	-	-	-	280	-	1



LUXOR®

7 / RACCORDI

RACCORDI

RACCORDI A STRINGERE PER TUBI RAME, PLASTICA E MULTISTRATO



CARATTERISTICHE TECNICHE



Max temperatura

120 °C



Max pressione

10 bar



Dadi

CW617N
UNI EN
12165:2016

Raccordi

CW614N
UNI EN
12164:2016

Guarnizioni OR

EPDM



Guarnizioni

Polietilene

ATTACCHI IMPIANTO



Tubo ferro

W 24x19 - TR 91
G 3/4 EK - TR 91/A
G 1/2 - TR 890
G 1/2 - TR 94
G 1/2 - TR 92

Tubo rame

W 24x19 - TR 91
G 3/4 EK - TR 91/A
G 1/2 - TR 890
G 1/2 - TR 94
G 1/2 - TR 92

Tubo plastica

W 24x19 - TP 95
G 3/4 EK - TP 98
G 1/2 - TP 93

Tubo multistrato

W 24x19 - TP 97
G 3/4 EK - TP 99
G 1/2 - TP 96
G 1/2 F - TP 90

ISTRUZIONI OPERATIVE

Per evitare inconvenienti derivanti da un montaggio non corretto, i quali potrebbero risultare molto onerosi, si consiglia di seguire queste brevi istruzioni:

• Preparazione del tubo.

1. **Taglio del tubo.** Per eseguire un taglio corretto, utilizzare le cesoie apposite in modo da non ovalizzare il tubo e facendo particolare attenzione che il taglio sia perpendicolare all'asse del tubo.

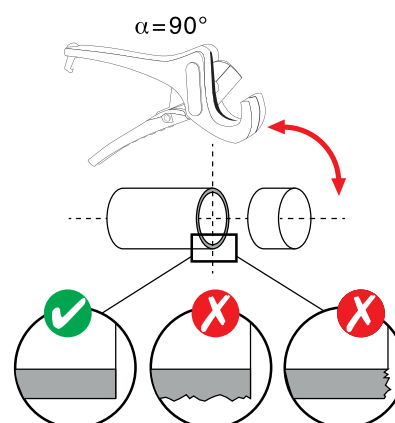

Le caratteristiche del fluido dell'impianto devono essere conformi alla direttiva UNI 8065:2019.

2. Calibratura. Questa operazione consente di ottenere il diametro interno corretto.

3. Svasatura. L'operazione di svasatura crea uno smusso interno che facilita l'inserimento dei raccordi nel tubo ed evita che gli o-rings possano fuoriuscire dalle loro sedi.

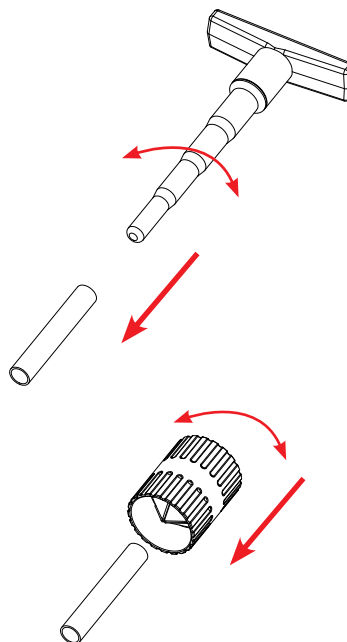

CORRETTO ASSEMBLAGGIO DEL RACCORDO A STRINGERE

Montare gli elementi che compongono il raccordo nell'ordine e verso indicato nelle figure.

RACCORDI PER TUBO RAME/ACCIAIO DOLCE			RACCORDI PER TUBO PLASTICA	RACCORDI PER TUBO MULTISTRATO
TR 91 • TR 91/A	TR 92	TR 94	TP 93 • TP 95 • TP 98	TP 96 • TP 97 • TP 99

Inserire il tubo con relativo portagomma nella tasca del raccordo avendo cura che la stessa sia pulita ed evitando di pizzicare l'o-ring di tenuta.

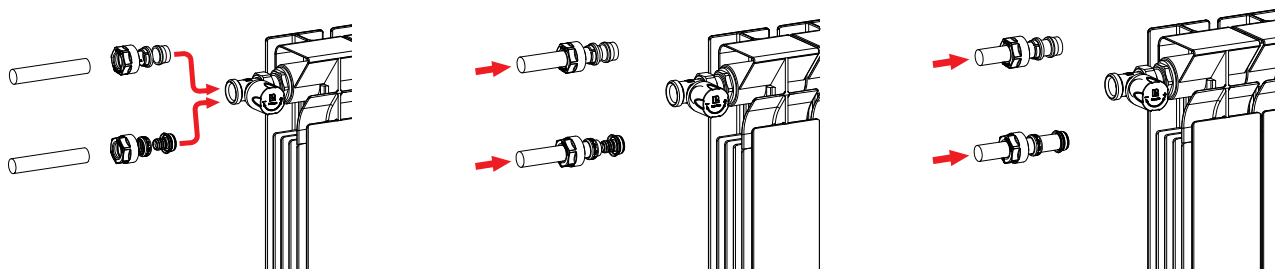

È assolutamente vietato lubrificare le parti in gomma con oli o grassi a base minerale: la miscela EPDM è compatibile solo con lubrificanti a base siliconica. Per evitare qualsiasi equivoco, si consiglia di lubrificare le parti in gomma semplicemente con acqua.

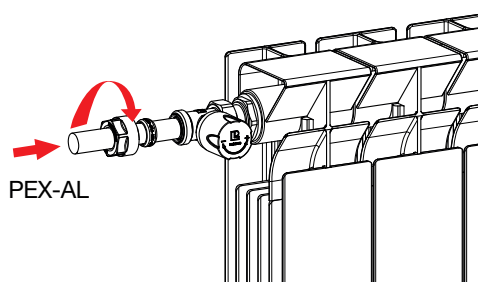
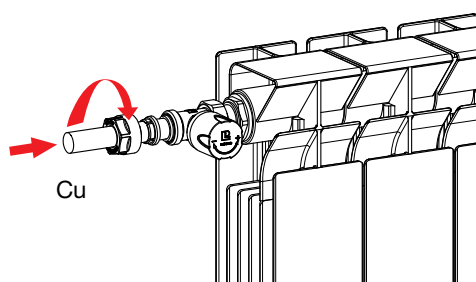
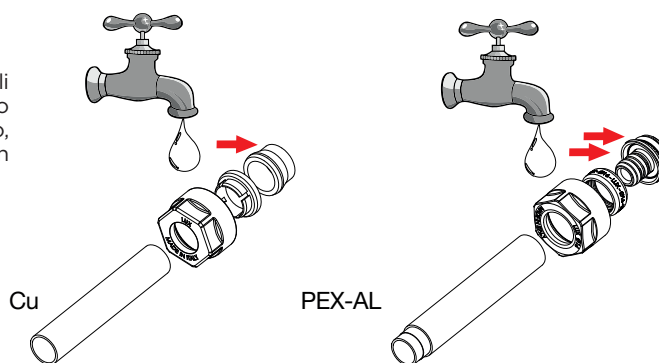

Imboccare il dado ed avvitarlo a mano fino a quando è possibile e quindi a fondo con l'apposita chiave art. CH 110.

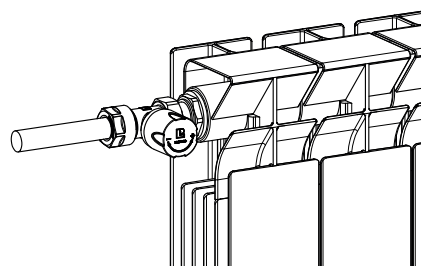
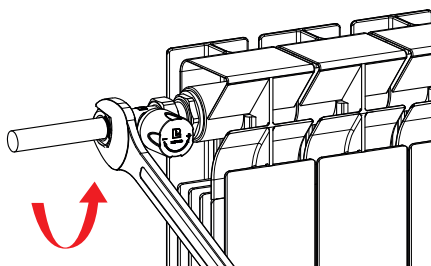

COPPIE DI SERRAGGIO

Per un uso corretto della raccorderia è indispensabile seguire la tabella sotto indicata, riguardante le coppie di serraggio dei dadi a seconda della tipologia di raccordo e della natura del tubo.



MISURA TUBO	RAME RICOTTO	RAME SEMIDURO	ACCIAIO DOLCE	POLIETILENE POLIPROPILENE POLIBUTENE	MULTISTRATO PEX-AL-PEX
Fino a Ø 18 mm	Da 35 a 45 Nm	Da 60 a 80 Nm	Da 60 a 70 Nm	Da 40 a 50 Nm	Da 25 a 35 Nm
Oltre Ø 18 mm	-	-	-	Da 40 a 50 Nm	Da 25 a 35 Nm

RACCORDI PER TUBO RAME



TR 92

Raccordo a compressione con ogiva in ottone per tubo rame o acciaio morbido. Conforme secondo il D.M. 174/2004.

CODICE	MISURA			
67611400	14 mm	24	100	800
67611500	15 mm	21	100	800

filetto G1/2



TR 94

Raccordo a compressione con ogiva in ottone a tenuta o-ring per tubo rame o acciaio morbido per raccordi sottotraccia G1/2.

CODICE	MISURA			
67621500	15 mm	20	100	800

filetto G1/2



TR 890

Raccordo a compressione morbida con ogiva in PTFE/CV - per tubo rame - filetto da G1/2.

CODICE	MISURA			
68720010	10 mm	26	50	400
68720012	12 mm	25	50	400
68720014	14 mm	20	50	400
68720016	16 mm	19	50	400

filetto G1/2



TR 91

Raccordo a compressione morbida con ogiva in EPDM - per tubo rame - filetto da W24x19.

CODICE	MISURA			
67760010	10 mm	52	50	400
67760012	12 mm	44	50	400
67760014	14 mm	42	50	400
67760015	15 mm	40	50	400
67760016	16 mm	38	50	400
67760018	18 mm	36	50	400

filetto W24x19



TR 91/A

Raccordo a compressione morbida con ogiva in EPDM - per tubo rame - filetto da G3/4 eurocono.

CODICE	MISURA			
67761000	10 mm	54	40	320
67761200	12 mm	52	40	320
67761400	14 mm	50	40	320
67761500	15 mm	50	40	320
67761600	16 mm	48	40	320
67761800	18 mm	46	40	320



filetto G3/4 eurocono



RACCORDI PER TUBO IN POLIETILENE, POLIBUTENE E POLIPROPILENE

TP 93



Raccordo a compressione per tubo in polietilene, polibutene e polipropilene, filetto da G1/2.

CODICE	MISURA			
67801208	12 x 2	56	50	400
67801510	15 x 2,5	48	50	400
67801612	16 x 2	45	50	400
67801616	16 x 2,2	44	50	400

filetto G1/2

TP 95



Raccordo a compressione per tubo in polietilene, polibutene e polipropilene, filetto da W24x19.

CODICE	MISURA			
67781008	10,5 x 1,25	62	50	400
67781210	12 x 1	52	50	400
67781209	12 x 1,5	60	50	400
67781208	12 x 2	59	50	400
67781410	14 x 2	60	50	400
67781511	15 x 2	54	50	400
67781510	15 x 2,5	56	50	400
67781613	16 x 1,5	52	50	400
67781612	16 x 2	56	50	400
67781616	16 x 2,2	56	50	400
67781611	16 x 2,5	56	50	400
67781628	16 x 2,8	56	50	400
67781713	17 x 2	50	50	400
67781814	18 x 2	48	50	400
67781813	18 x 2,5	48	50	400
67782016	20 x 2	60	50	400
67782017	20 x 2,8	68	50	400
67782034	20 x 3,4	60	50	400

filetto W24x19



TP 98

Raccordo a compressione per tubo in polietilene, polibutene e polipropilene, filetto G3/4 eurocono.

CODICE	MISURA			
67841007	10 x 1,2	76	40	320
67841209	12 x 1,5	76	40	320
67841208	12 x 2	76	40	320
67841410	14 x 2	70	40	320
67841510	15 x 2,5	70	40	320
67841613	16 x 1,5	60	40	320
67841618	16 x 1,8	60	40	320
67841612	16 x 2	60	40	320
67841616	16 x 2,2	68	40	320
67841713	17 x 2	58	40	320
67841814	18 x 2	68	40	320
67842016	20 x 2	57	40	320
67842028	20 x 2,8	64	40	320
67842034	20 x 3,4	60	40	320

filetto G3/4 eurocono

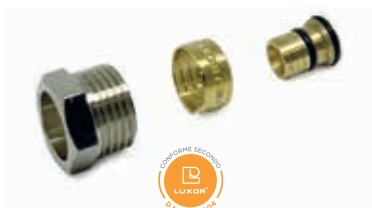
RACCORDI PER TUBO IN POLIETILENE MULTISTRATO PEX-AL-PEX



TP 90

Raccordo a compressione per tubo in polietilene multistrato PEX-AL-PEX per attacco tubo ferro G1/2.

CODICE	MISURA			
67631612	16 x 2	27	50	400

filetto G1/2



TP 96

Raccordo a compressione per tubo in polietilene multistrato PEX-AL-PEX filetto G1/2.

CODICE	MISURA			
67871410	14 x 2	56	50	400
67871612	16 x 2	57	50	400
67871611	16 x 2,25	52	50	400

filetto G1/2



TP 97

Raccordo a compressione per tubo in polietilene multistrato PEX-AL-PEX filetto da W24x19.

CODICE	MISURA			
67821410	14 x 2	54	50	400
67821612	16 x 2	52	50	400
67821611	16 x 2,25	52	50	400
67821626	16,2 x 3	52	50	400
67821711	17 x 2,75	49	50	400
67821713	17 x 2	50	50	400
67821712	17 x 2,5	50	50	400
67821814	18 x 2	50	50	400
67822016	20 x 2	66	50	400
67822017	20 x 2,25	64	50	400
67822015	20 x 2,5	62	50	400
67822014	20 x 3	62	50	400

filetto W24x19

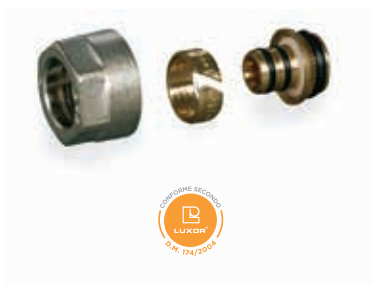

TP 99

Raccordo a compressione per tubo in polietilene multistrato PEX-AL-PEX filetto G3/4 eurocono.

CODICE	MISURA			
67861210	12,2 x 1,3	74	40	320
67861410	14 x 2	78	40	320
67861512	15 x 1,5	63	40	320
67861612	16 x 2	74	40	320
67861611	16 x 2,25	74	40	320
67861610	16,2 x 3	74	40	320
67861713	17 x 2	74	40	320
67861712	17 x 2,5	74	40	320
67861711	17 x 2,75	70	40	320
67861814	18 x 2	74	40	320
67862016	20 x 2	78	40	320
67862017	20 x 2,25	76	40	320
67862015	20 x 2,5	74	40	320
67862014	20 x 3	72	40	320

filetto G3/4 eurocono

RACCORDI A STRINGERE CROMATI E VERNICIATI PER TUBO RAME

CHROME





WHITE



BLACK

TR 91/AC

Raccordo a compressione morbida con ogiva in EPDM - per tubo rame - filetto da G3/4 **eurocono**.

CODICE	MISURA	FINITURA			
67761000C	10 mm	CHROME	57	20	240
67761200C	12 mm	CHROME	54	20	240
67761400C	14 mm	CHROME	51	20	240
67761500C	15 mm	CHROME	48	20	240
67761600C	16 mm	CHROME	46	20	240
67761000B	10 mm	WHITE	57	20	240
67761200B	12 mm	WHITE	54	20	240
67761400B	14 mm	WHITE	51	20	240
67761500B	15 mm	WHITE	48	20	240
67761600B	16 mm	WHITE	46	20	240
67761000N	10 mm	BLACK	57	20	240
67761200N	12 mm	BLACK	54	20	240
67761400N	14 mm	BLACK	51	20	240
67761500N	15 mm	BLACK	48	20	240
67761600N	16 mm	BLACK	46	20	240

filetto G3/4 eurocono

RACCORDI A STRINGERE CROMATI E VERNICIATI PER TUBO IN POLIETILENE, POLIBUTENE E POLIPROPILENE

CHROME





WHITE



BLACK

TP 98/C

Raccordo a compressione per tubo in polietilene, polibutene e polipropilene, filetto da G3/4 **eurocono**.

CODICE	MISURA	FINITURA			
67841410C	14 x 2	CHROME	65	20	240
67841612C	16 x 2	CHROME	61	20	240
67841713C	17 x 2	CHROME	58	20	240
67841814C	18 x 2	CHROME	59	20	240
67842016C	20 x 2	CHROME	57	20	240
67841410B	14 x 2	WHITE	65	20	240
67841612B	16 x 2	WHITE	61	20	240
67841713B	17 x 2	WHITE	58	20	240
67841814B	18 x 2	WHITE	59	20	240
67842016B	20 x 2	WHITE	57	20	240
67841410N	14 x 2	BLACK	65	20	240
67841612N	16 x 2	BLACK	61	20	240
67841713N	17 x 2	BLACK	58	20	240
67841814N	18 x 2	BLACK	59	20	240
67842016N	20 x 2	BLACK	57	20	240

filetto G3/4 eurocono

RACCORDI A STRINGERE CROMATI E VERNICIATI PER TUBO IN POLIETILENE MULTISTRATO PEX-AL-PEX



CHROME





WHITE



BLACK

TP 99/C

Raccordo a compressione per tubo in polietilene multistrato PEX-AL-PEX, filetto da G3/4 **eurocono**.

CODICE	MISURA	FINITURA			
67861410C	14 x 2	CHROME	67	20	240
67861612C	16 x 2	CHROME	65	20	240
67861611C	16 x 2.25	CHROME	60	20	240
67861713C	17 x 2	CHROME	60	20	240
67861814C	18 x 2	CHROME	61	20	240
67862016C	20 x 2	CHROME	59	20	240
67861410B	14 x 2	WHITE	67	20	240
67861612B	16 x 2	WHITE	65	20	240
67861611B	16 x 2.25	WHITE	60	20	240
67861713B	17 x 2	WHITE	60	20	240
67861814B	18 x 2	WHITE	61	20	240
67862016B	20 x 2	WHITE	59	20	240
67861410N	14 x 2	BLACK	67	20	240
67861612N	16 x 2	BLACK	65	20	240
67861611N	16 x 2.25	BLACK	60	20	240
67861713N	17 x 2	BLACK	60	20	240
67861814N	18 x 2	BLACK	61	20	240
67862016N	20 x 2	BLACK	59	20	240

filetto G3/4 eurocono

RACCORDI SOTTOTRACCIA PER LA DISTRIBUZIONE CON TUBI SFILABILI

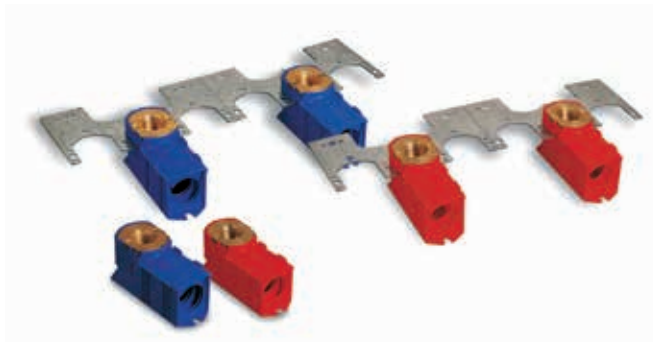

CARATTERISTICHE COSTRUTTIVE

I raccordi Luxor sono prodotti per soddisfare le moderne esigenze di utilizzo del tubo in plastica sfilabile per la distribuzione sanitaria e di riscaldamento.

I principali vantaggi di questo prodotto sono:

- facilità nella posa delle tubazioni;
- possibilità di manutenzione senza danneggiare le pareti, agendo all'interno delle scatole di plastica che isolano i raccordi dall'intonaco;
- bassa rumorosità del sistema grazie all'assenza di giunzioni che creano turbolenze;
- qualità estetica dell'impianto finito.

I raccordi sono prodotti in ottone resistente alla dezincificazione CW626N UNI EN 12165:2016.

Tutte le guarnizioni di tenuta sono in EPDM perossidico.

Le scatole in plastica che racchiudono i raccordi sono in polipropilene con carica di talco.

Utilizzando il tubo di raccordo in rame cromato articolo M 528, si avrà la tenuta garantita tramite un o-ring e una resa esteti-

CARATTERISTICHE TECNICHE



Max temperatura

120 °C



Max pressione

10 bar

ca assicurata da un tubo cromato di collegamento sempre in asse con il raccordo e la parete.

Le staffe articolo SS 1982 sono in ferro zincato FeZ100-EN10142-92 e sono frazionabili. Questi articoli permettono di posizionare con velocità e sicurezza i raccordi alle profondità volute rispetto all'intonaco e con gli interassi corretti per il collegamento agli apparecchi sanitari.

Tutti i raccordi con attacco per il collegamento al tubo di rame o plastica vengono forniti senza i relativi raccordi montati.



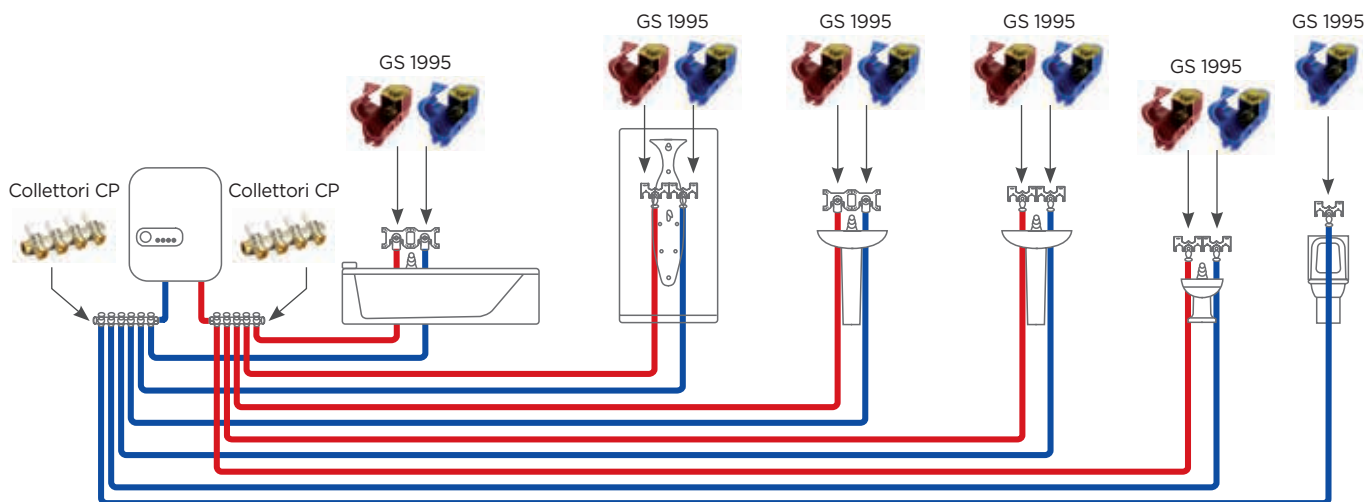

IMPIANTO PER LA DISTRIBUZIONE SANITARIA CON UNA MANDATA PER OGNI UTENZA

Questa tipologia di impianto è la più comune, prevede che ogni utenza sia collegata direttamente ad una uscita del collettore di distribuzione.

I **vantaggi** di questo tipo di impianti sono:

- pressione costante per ogni utenza;
- possibilità di regolare la portata per ogni singola utenza;
- facilità di manutenzione;

Gli **svantaggi** sono:

- elevata quantità di tubo utilizzata;
- cassette di distribuzione di grosse dimensioni.

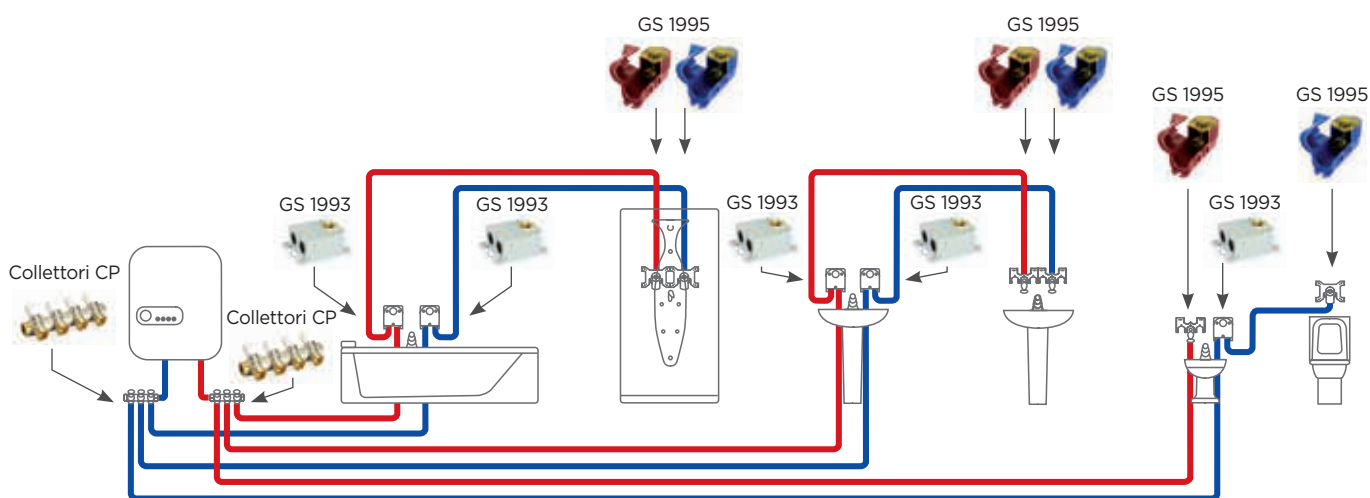

IMPIANTO PER LA DISTRIBUZIONE SANITARIA A BLOCCHI

Questa tipologia di impianto prevede di dividere le utenze per gruppi.

I **vantaggi** di questo tipo di impianti sono:

- ridotto costo di realizzazione;
- minore ingombro occupato dai tubi e dalla cassetta di distribuzione.

Gli **svantaggi** sono:

- nel caso di uso contemporaneo di più utenze, il flusso d'acqua è ripartito tra i vari utilizzatori.

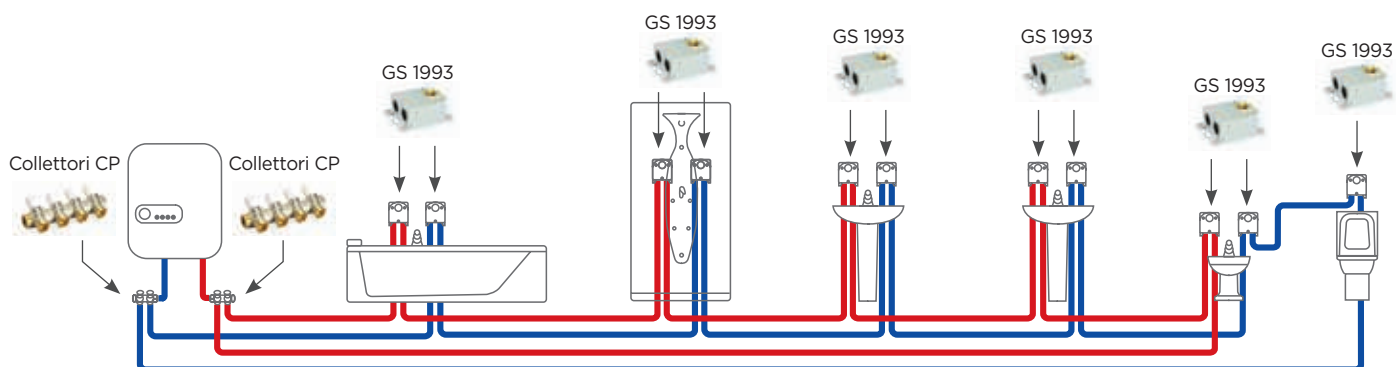

IMPIANTO MOTUBO PER LA DISTRIBUZIONE SANITARIA

Questa tipologia è la più semplice.

I **vantaggi** di questo tipo di impianti sono:

- semplicità di realizzazione;
- minimo ingombro di tubi e cassetta di distribuzione;
- ridotto costo di realizzo.

Gli **svantaggi** sono:

- nel caso di uso contemporaneo di più utenze, il flusso d'acqua è ripartito tra i vari utilizzatori.

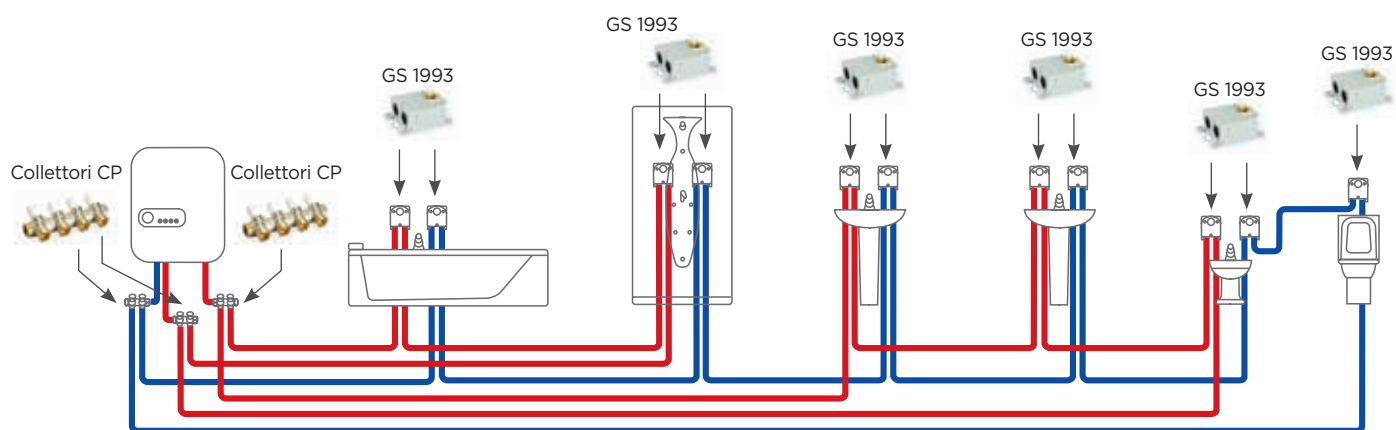

IMPIANTO PER LA DISTRIBUZIONE SANITARIA CON RICIRCOLO COMFORT

Questa tipologia di impianto prevede di realizzare un ricircolo per l'acqua calda.

I **vantaggi** di questo tipo di impianti sono:

- massimo comfort, in quanto l'acqua calda è immediatamente disponibile, indipendentemente dalla distanza dalla caldaia.

Gli **svantaggi** sono:

- elevato costo di realizzazione;
- utilizzo di tubi coibentati per ridurre la dispersione termica;
- realizzazione di un apposito circuito di ricircolo.

RACCORDI SOTTOTRACCIA PER LA DISTRIBUZIONE CON TUBI SFILABILI

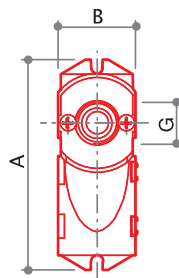

GS 1995

Raccordo curvo sottotraccia a 90° singolo di colore blu o rosso, senza staffa e con tappo in ottone con o-ring per prova di tenuta.

Raccordi

TR 91 TP 95 TP 97
*TR 91/A *TP 98 *TP 99

CODICE	MISURA	A	B	C	D	E	F	G	H	L	Ⓜ	📦	📦
66004100B	G 1/2 x (W24x19)	104	38	50	-	-	W24x19	G 1/2	-	-	124	8	64
66004100R	G 1/2 x (W24x19)	104	38	50	-	-	W24x19	G 1/2	-	-	124	8	64
66004102B*	G 1/2 x G 3/4 EK	104	38	50	-	-	G 3/4 EK	G 1/2	-	-	127	8	64
66004102R*	G 1/2 x G 3/4 EK	104	38	50	-	-	G 3/4 EK	G 1/2	-	-	127	8	64



RC 914

Raccordo curvo sottotraccia 90°.

CODICE	MISURA	FINITURA	📏	📏	📏	Ⓜ	📦	📦
68549899	G 1/2 x (W24x19)	GIALLA	TR 91	TP 95	TP 97	75	30	240
68549901	G 1/2 x G 3/4 EK	GIALLA	TR 91/A	TP 98	TP 99	78	30	240
68549899N	G 1/2 x (W24x19)	NICHELATA	TR 91	TP 95	TP 97	75	30	240
68549901N	G 1/2 x G 3/4 EK	NICHELATA	TR 91/A	TP 98	TP 99	78	30	240

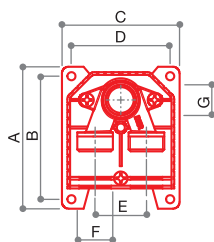

CS 1993

Raccordo doppio, sistema monotubo, con alloggiamento sottotraccia.

Raccordi

TR 91 TP 95 TP 97
*TR 91/A *TP 98 *TP 99

CODICE	MISURA	A	B	C	D	E	F	G	H	L	Ⓜ	📦	📦
66002200	G 1/2 x (W24x19)	105	91	87	73	38	W24x19	G 1/2	-	-	288	6	48
66002201*	G 1/2 x G 3/4 EK	105	91	87	73	38	G 3/4 EK	G 1/2	-	-	294	6	48

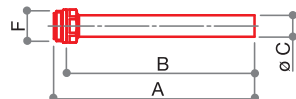

M 528

Tubo di raccordo in rame cromato a tenuta morbida per scatola di distribuzione sottotraccia.

CODICE	MISURA	A	B	C	D	E	F	G	H	L	Ⓜ	📦	📦
67510015	G 1/2 x (Ø 15 x 140)	140	131	15	-	-	G 1/2	-	-	-	70	35	280
67520015	G 1/2 x (Ø 15 x 175)	175	166	15	-	-	G 1/2	-	-	-	80	30	240

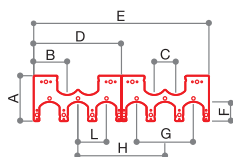

SS 1982

Staffa doppia frazionabile in due staffe singole per raccordi sottotraccia: art. GS 1995, GS 1996 interasse 38-50-100-153.

CODICE	MISURA	A	B	C	D	E	F	G	H	L	Ⓜ	📦	📦
66004000	-	80	58	38	154	308	34	100	153	50	142	25	150

RACCORDI PER TUBI IN RAME, PLASTICA E MULTISTRATO

CARATTERISTICHE TECNICHE



Max temperatura

120 °C



Max pressione

10 bar

CARATTERISTICHE COSTRUTTIVE

I raccordi Luxor sono prodotti in ottone con finitura gialla o nichelata in due versioni:

- resistente alla dezincificazione CW626N UNI EN 12165:2016;
- a basso contenuto di piombo in conformità alle più recenti normative: CW617N UNI EN 12165:2016.

Gli o-ring e le altre guarnizioni di tenuta sono in EPDM perossidico. La staffa articolo SS 1984 è in ferro zincato Fe Z100-EN 10142-92.

Questa staffa permette di posizionare con velocità e sicurezza i raccordi agli interessi corretti.

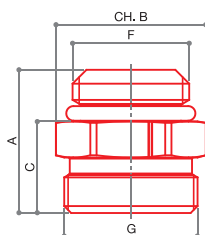



RD 900

Raccordo diretto con tenuta o-ring per collegamento ai collettori di distribuzione serie CD.

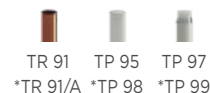
Raccordi



CODICE	MISURA	A	B	C	D	E	F	G	H	L	FINITURA			
68559824	G 1/2 x (W24x19)	26	24	16.5	-	-	G 1/2	W24x19	-	-	GIALLA	42	50	400
68552700*	G 1/2 x G 3/4 EK	26	27	17	-	-	G 1/2	G 3/4 EK	-	-	GIALLA	51	50	400
68559817N**	G 3/8 x (W24x19)	24	24	15	-	-	G 3/8	W24x19	-	-	NICHELATA	36	100	800
68559824N	G 1/2 x (W24x19)	26	24	16.5	-	-	G 1/2	W24x19	-	-	NICHELATA	42	50	400
68552700N*	G 1/2 x G 3/4 EK	26	27	17	-	-	G 1/2	G 3/4 EK	-	-	NICHELATA	51	50	400

** Articolo in esaurimento

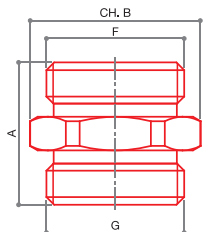



RD 902

Raccordo diretto M-M.

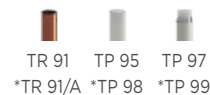
Raccordi



CODICE	MISURA	A	B	C	D	E	F	G	H	L			
68549824N	G 1/2 x (W24x19)	32.5	24	-	-	-	R 1/2	W24x19	-	-	46	50	400
68549827N	G 3/4 x (W24x19)	27	27	-	-	-	G 3/4 EK	W24x19	-	-	46	50	400
68559822N	(W24x19) x (W24x19)	26.5	24	-	-	-	W24x19	W24x19	-	-	42	50	400
68559823N*	G 3/4 EK x G 3/4 EK	27.5	30	-	-	-	G 3/4 EK	G 3/4 EK	-	-	62	50	400



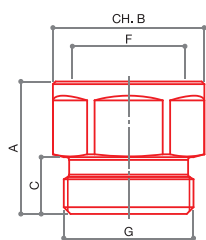

RD 903

Raccordo diritto F-M.

Raccordi



CODICE	MISURA	A	B	C	D	E	F	G	H	L			
68549838N	G 1/2 x (W24x19)	24.5	25	10.5	-	-	G 1/2	W24x19	-	-	42	50	400
68549739N*	G 1/2 x G 3/4 EK	26	27	10.5	-	-	G 1/2	G 3/4 EK	-	-	60	50	400
68549743N*	G 3/4 x G 3/4 EK	25	30	10.5	-	-	G 3/4	G 3/4 EK	-	-	51	50	400
68549740N	G 3/4 x (W24x19)	25	31	10.5	-	-	G 3/4	W24x19	-	-	58	50	400
68549741N	(W24x19) x (W24x19)	25	27	10	-	-	W24x19	W24x19	-	-	48	50	400
68549742N**	(W24x19) x G 1/2	24	27	10	-	-	W24x19	G 1/2	-	-	40	50	400

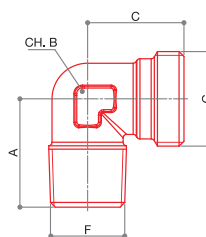

RC 904

Raccordo curvo M-M.

Raccordi

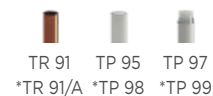

CODICE	MISURA	A	B	C	D	E	F	G	H	L			
68549847N	G 1/2 x (W24x19)	30	20	27	-	-	R 1/2	W24x19	-	-	64	50	400
68549746N*	G 1/2 x G 3/4 EK	30	20	27	-	-	R 1/2	G 3/4 EK	-	-	70	30	240

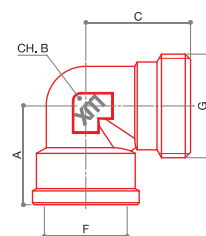

RC 905

Raccordo curvo F-M.

Raccordi

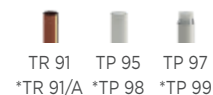

CODICE	MISURA	A	B	C	D	E	F	G	H	L			
68549856N	G 1/2 x (W24x19)	25	20	26.5	-	-	G 1/2	W24x19	-	-	79	50	400
68549755N*	G 1/2 x G 3/4 EK	25	20	26.5	-	-	G 1/2	G 3/4 EK	-	-	76	30	240
68549757N*	G 3/4 x G 3/4 EK	36.5	25	33	-	-	G 3/4	G 3/4 EK	-	-	148	25	200

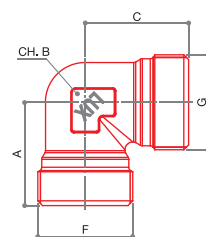

RC 906

Raccordo curvo M-M.

Raccordi

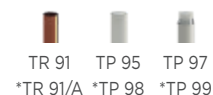

CODICE	MISURA	A	B	C	D	E	F	G	H	L			
68549865N	(W24x19) x (W24x19)	26	20	26	-	-	W24x19	W24x19	-	-	62	50	400
68549747N*	G 3/4 EK x G 3/4 EK	33	25	33	-	-	G 3/4 EK	G 3/4 EK	-	-	145	25	200

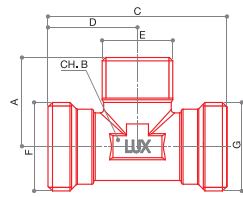

RT 907
Raccordo a T MxMxM.

Raccordi

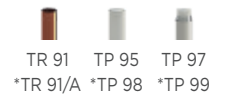

CODICE	MISURA	A	B	C	D	E	F	G	H	L			
68549870N	G 1/2 x (W24x19) x (W24x19)	30	20	53	26.5	G 1/2	W24x19	W24x19	-	-	82	30	240
68549770N*	G 1/2 x G 3/4 EK x G 3/4 EK	27	20	53	26.5	G 1/2	G 3/4 EK	G 3/4 EK	-	-	86	25	200

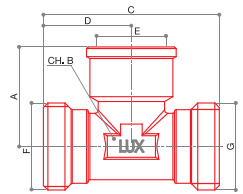

RT 908
Raccordo a T FxMxM.

Raccordi

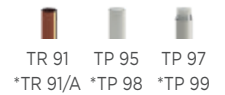

CODICE	MISURA	A	B	C	D	E	F	G	H	L			
68549879N	G 1/2 x (W24x19) x (W24x19)	30	20	53	26.5	G 1/2	W24x19	W24x19	-	-	98	30	240
68549779N*	G 1/2 x G 3/4 EK x G 3/4 EK	30	20	53	26.5	G 1/2	G 3/4 EK	G 3/4 EK	-	-	96	25	200

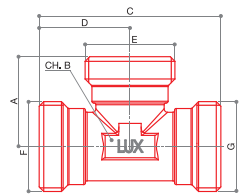

RT 911
Raccordo a T.

Raccordi

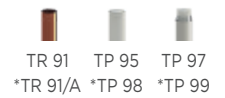

CODICE	MISURA	A	B	C	D	E	F	G	H	L			
68549890N	(W24x19) x (W24x19) x (W24x19)	26.5	20	53	26.5	W24x19	W24x19	W24x19	-	-	78	30	240
68549790N*	G 3/4 EK x G 3/4 EK x G 3/4 EK	26.5	20	53	26.5	G 3/4 EK	G 3/4 EK	G 3/4 EK	-	-	96	25	200

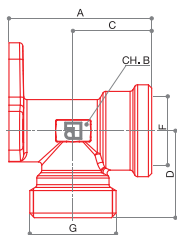

RC 912

Raccordo murale curvo con flangia.

Raccordi

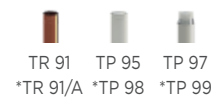

CODICE	MISURA	A	B	C	D	E	F	G	H	L			
69549895N	G 1/2 x (W24x19)	43	19	24	26.5	-	G 1/2	W24x19	-	-	109	30	240
69549795N*	G 1/2 x G 3/4 EK	43.5	19	24	26.5	-	G 1/2	G 3/4 EK	-	-	100	25	200
69549794N*	G 3/4 x G 3/4 EK	57	21	37	27	-	G 3/4	G 3/4 EK	-	-	138	20	160

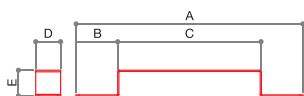

SS 1984

Staffa per raccordi murali con flangia art. RC 912 e RM.

CODICE	MISURA	A	B	C	D	E	F	G	H	L			
66001200	-	382	70	242	42	43.5	-	-	-	-	280	-	50



RD 923

Raccordo diritto con attacco maschio e raccordo portagomma fisso per tubo in polietilene rivestito (multistrato).

CODICE	MISURA			
69549925N	G 3/4 x 25 x 2,5	170	15	120
69549926N	G 3/4 x 26 x 3	172	15	120
69549927N	G 1" x 32 x 3	255	12	96



RC 480

Raccordo curvo in tre pezzi con tenuta o-ring.

CODICE	MISURA	FINITURA			
67952100	G 1/2	GIALLA	128	25	200
67952700	G 3/4	GIALLA	212	15	120
67953400	G 1"	GIALLA	372	8	64
67952100N	G 1/2	NICHELATA	128	25	200
67952700N	G 3/4	NICHELATA	212	15	120
67953400N	G 1"	NICHELATA	372	8	64



**RD 482**

Raccordo diritto in tre pezzi con tenuta o-ring.

CODICE	MISURA	FINITURA			
67972100	G 1/2	GIALLA	105	30	240
67972700	G 3/4	GIALLA	175	15	120
67973400	G 1"	GIALLA	303	12	96
67972100N	G 1/2	NICHELATA	105	30	240
67972700N	G 3/4	NICHELATA	175	15	120
67973400N	G 1"	NICHELATA	303	12	96



**RC 481**

Raccordo curvo nichelato in tre pezzi con doppia tenuta o-ring.

CODICE	MISURA			
67952101N	G 1/2	128	20	160
67952701N	G 3/4	212	12	96
67953401N	G 1"	372	6	48

**RD 483**

Raccordo diritto nichelato in tre pezzi con doppia tenuta o-ring.

CODICE	MISURA			
67972101N	G 1/2	106	25	200
67972701N	G 3/4	162	12	96
67973401N	G 1"	256	10	80

**CH 110**

Chiave per raccordi a compressione.

CODICE	MISURA			
67822724	CH 24-27 mm	352	10	80

CONDIZIONI GENERALI DI VENDITA

1 PREMESSE - 1.1 Le presenti condizioni di vendita si applicano a tutte le forniture di Prodotti Luxor Spa (di seguito "Luxor"). Qualsiasi condizione generale, ed in particolare le condizioni di acquisto dell'Acquirente (di seguito "Cliente"), salvo espressa accettazione scritta da parte di Luxor, non vincoleranno quest'ultima né esimeranno il Cliente dall'applicazione delle presenti Condizioni Generali (di seguito CVG)

2 ORDINI - 2.1 Gli Ordini di Acquisto (di seguito "Ordini"), rappresentano un irrevocabile proposta d'acquisto, comportando per i clienti, l'automatica accettazione delle presenti Condizioni Generali di Vendita.

2.2 Gli Ordini non s'intendono accettati finché non siano stati confermati per iscritto da Luxor. L'emissione da parte di quest'ultima della conferma d'Ordine e/o della Fattura, sarà considerata quale conferma.

2.3 Eventuali modifiche dell'Ordine richieste dal Cliente successivamente all'invio della Conferma d'ordine, saranno valide ed esecutive, solo in seguito ad accettazione scritta di Luxor. La cancellazione o la modifica degli Ordini senza il preventivo consenso scritto di Luxor, daranno titolo a quest'ultima di agire per ottenere il rimborso dei costi sostenuti, fatto salvo il diritto al risarcimento del maggior danno.

3 PREZZI - 3.1 Il prezzo dei prodotti Luxor sarà fatturato in base al listino vigente al momento dell'accettazione dell'Ordine. Tutti i prezzi sono intesi IVA ed ulteriori eventuali imposte escluse.

3.2 I prezzi indicati nei cataloghi/listini di vendita hanno un carattere meramente indicativo e potranno subire variazioni in ragione dell'aumento dei costi di produzione. In questa eventualità, Luxor provvederà a comunicare gli aumenti dei prezzi alla parte acquirente indicandone le cause.

4 TERMINI DI CONSEGNA - 4.1 Le forniture oggetto di ogni singolo Ordine saranno consegnate entro i termini riportati in seno alla Conferma d'Ordine.

4.2 Nessuna responsabilità sarà ascrivibile alla Luxor, ove il ritardo nella consegna non sia a quest'ultima imputabile, come in caso di ritardi di terzi, inclusi fornitori e subfornitori, spedizionieri ed eventuali cause di forza maggiore che comportino l'inattività totale o parziale degli stabilimenti. Nei suddetti casi, la consegna della merce, anche se parziale, non può essere rifiutata dal Cliente e quest'ultimo non potrà avvalersi del ritardo nella consegna per risolvere il contratto e/o richiedere indennizzi a titolo di risarcimento danni.

5 SPEDIZIONI - 5.1 Fatti salvi eventuali diversi accordi, le consegne dei prodotti vengono effettuate in "Porto Assegnato" (Incoterms 2020 EXW), con spese e rischi connessi al trasporto posti a carico dell'acquirente.

5.2 Anche nel caso di consegna convenuta in "Porto Franco" (incoterms 2020 DDP) con spese a carico di Luxor, la merce viaggerà a rischio e pericolo dell'acquirente. Quali che siano i termini di resa pattuiti dalle Parti, i rischi passeranno all'Acquirente, al più tardi con la consegna al primo trasportatore.

5.3 Il trasferimento della proprietà dei beni è sospeso fino al completo pagamento del prezzo, senza che ciò abbia un impatto sul trasferimento dei rischi al compratore.

5.4 Per particolari tipi di imballaggio, saranno conteggiati in fattura gli extra prezzo indicati nel listino-prezzi o nella conferma d'Ordine.

6 PAGAMENTI - 6.1 I pagamenti sono dovuti nei termini e con le modalità stabilite nella conferma d'ordine e/o fattura.

6.2 Salvo diversa espressa pattuizione, i pagamenti dovranno essere effettuati alle coordinate bancarie di Luxor indicate nella fattura di vendita. I pagamenti dall'Estero, effettuati mediante bonifico bancario, dovranno avvenire con opzione OUR, così che l'importo esposto in fattura sia ricevuto da Luxor al netto di oneri bancari e/o spese. Nessun soggetto terzo (in particolare agenti e rappresentanti) è autorizzato ad incassare denaro per conto di Luxor.

6.3 Il Cliente, non potrà sospendere totalmente o parzialmente i pagamenti od anche ritardarli rispetto ai termini pattuiti, nemmeno in presenza di eventuali contestazioni o denunce di vizi e difetti.

6.4 Nel caso di interruzione o sospensione dei pagamenti, il Cliente sarà considerato ad ogni effetto di legge come inadempiente, con facoltà di Luxor di addebitare spese ed interessi di cui agli artt. 5 e 6 del D.Lgs n. 192/2012, sempre salvo il diritto alla risoluzione contrattuale. Il ritardo nei pagamenti dà altresì a Luxor il diritto di escludere la garanzia per tutto il periodo durante il quale il ritardo perdura.

6.5 Il mancato rispetto da parte del Cliente dei termini di pagamento pattuiti, così come, la loro interruzione o sospensione, consentirà a Luxor di sospendere le forniture in corso e/o condizionare l'esecuzione dell'ordine in corso al saldo dell'esposizione debitoria e/o recedere da tutti gli ulteriori contratti stipulati con il Cliente, annullando le condizioni di favore (sconti e/o omaggi) eventualmente concessi.

6.6 Il Cliente non può compensare ragioni di credito che assuma di vantare nei confronti di Luxor con debiti sempre assunti nei confronti di quest'ultima, salvo formale autorizzazione della stessa Luxor.

7 CLAUSOLA RISOLUTIVA ESPRESSA - 7.1 Luxor potrà risolvere il contratto con effetti immediati nel caso in cui il Cliente venga assoggettato a procedure concorsuali o di liquidazione nonché in caso di assoggettamento a procedure esecutive e/o a protesti, e lo stato delle condizioni economiche sia tale da far ragionevolmente presumere l'insolubilità dell'acquirente.

8 GARANZIA - 8.1 Luxor garantisce la conformità dei prodotti forniti, esenti da vizi che potrebbero renderli non idonei all'uso cui sono destinati. La garanzia potrà essere fatta valere qualora il difetto sia dovuto ad errori di fabbricazione o difetti di materie prime che rientrino nella responsabilità di Luxor.

8.2 La garanzia ha durata di 1 (un) anno dalla data di consegna ed è subordinata alla denuncia in forma scritta da parte del Cliente, entro 8 (otto) giorni a decorrere dalla consegna in caso di vizi apparenti, ovvero, in caso di vizi occulti, dal momento della scoperta e comunque non oltre dodici (12) mesi dalla consegna.

8.3 In caso di prodotti non conformi, e dopo aver ricevuto un rapporto dettagliato dal Cliente, Luxor potrà, a sua insindacabile scelta: a) fornire gratuitamente Franco Fabbrica al compratore prodotti dello stesso genere e quantità, dopo averne ottenuto la resa per la verifica. Qualsiasi reso deve essere sempre precedentemente concordato ed autorizzato da Luxor. La merce contestata dovrà essere rispedita in "Porto Franco" e con bolla accompagnatoria indicante i motivi della restituzione entro massimo 30 giorni dalla data del benessere di Luxor, pena la decadenza della validità dell'autorizzazione stessa.

8.4 Qualora Luxor in sede di verifica non riconosca viziati i prodotti, provvederà alla fatturazione di quelli inviati in sostituzione. Nel caso in cui non fosse possibile sostituire i Prodotti risultati difettosi, Luxor potrà emettere una nota di accredito in favore del Cliente, per un importo corrispondente al valore dei prodotti difettosi, senza che ciò comporti alcuna responsabilità in capo a Luxor per danni diretti, indiretti o consequenziali di ogni genere, derivanti da e/o connessi ai vizi o difetti dei Prodotti.

8.5 Rimane inteso che la presente garanzia non copre i casi di Installazione, uso e manutenzione, posti in essere in difformità alle istruzioni ed avvertenze riportate nei manuali di installazione, uso e manutenzione inviati in accompagnamento al prodotto, o esecuzione di interventi di installazione e/o riparazione eseguiti da personale non qualificato.

8.6 È comunque esclusa l'operatività della garanzia nelle ipotesi in cui l'Acquirente si renda inadempiente alle obbligazioni contrattuali.

8.7 La presente garanzia è esclusiva ed in sostituzione di ogni altra garanzia scritta, orale od implicita a cui, con l'accettazione delle presenti Condizioni generali, il Cliente dichiara di rinunciare espressamente, ivi compreso, il diritto di regresso derivante dalla vendita e/o installazione dei Prodotti a consumatore non professionista.

9. RISERVA DI PROPRIETÀ 9.1 La vendita dei Prodotti Luxor S.p.A viene effettuata con patto di riservato dominio. Pertanto i prodotti rimarranno di proprietà di Luxor S.p.A. fino al totale pagamento del prezzo da parte dell'acquirente.

10 CESSIONE DEL CONTRATTO 10.1 È vietata la cessione a terzi del Contratto e/o di alcun interesse, diritto e obbligazione ad esso collegati, senza specifica approvazione scritta da parte di Luxor.

11 PRIVACY - 11.1 Il Cliente dichiara di avere preso visione dell'informativa ai sensi degli artt. 13 e 14 del Regolamento (UE) 2016/679 (GDPR) e s.m.i, consultabili al seguente indirizzo, <https://luxor.it/privacy-policy>, e con l'accettazione delle presenti CGC, fornisce il consenso al trattamento dei propri dati personali

11.2 I dati personali forniti dal Cliente, saranno trattati da Luxor, anche tramite soggetti esterni, per permettere gli adempimenti di obblighi di legge, nonché gli adempimenti informativi, amministrativi e commerciali connessi all'esecuzione del rapporto contrattuale.

12 LEGGE APPLICABILE E FORO COMPETENTE - 12.1 Contratto è regolato dal diritto italiano. Quanto non espressamente disciplinato dalle presenti CVG, sarà regolato dalle norme sulla vendita previste dagli articoli 1470 e seguenti del Codice Civile.

12.2 Le Parti escludono espressamente l'applicazione della Convenzione di Vienna sui contratti per la vendita internazionale di beni. Tutte le controversie che dovessero insorgere in relazione al Contratto, comprese quelle inerenti alla sua validità, interpretazione, esecuzione e risoluzione, saranno deferite in via esclusiva al Tribunale di Brescia.

12.3 In ogni caso, Luxor si riserva il diritto di agire presso il foro competente della sede del Cliente per azioni volte al recupero del credito. In tal caso troverà applicazione la legge locale.

13 CLAUSOLE FINALI - 13.1 L'eventuale nullità e/o inefficacia di una o più disposizioni delle presenti CVG, non incide sulla validità del contratto nel suo complesso.

13.2 Qualsiasi modifica al Contratto sarà valida soltanto se effettuata per iscritto e firmata da rappresentanti autorizzati di entrambe le Parti.

Il Cliente, nel dare atto di non rivestire la qualità di "consumatore", con conseguente esclusione dell'applicazione delle disposizioni di legge relative ai rapporti tra imprenditori e consumatori, dichiara di aver posto particolare attenzione alle seguenti clausole: · 1. Premesse (1.1); · 2. Ordini (2.1 - 2.2 - 2.3); · 3. Prezzi (3.2); 4. Termini di consegna (4.1 - 4.2); · 5. Spedizioni (5.1 - 5.2 - 5.3); · 6. Pagamenti (6.2 - 6.3 - 6.4 - 6.5 - 6.6); · 7 Clausola risolutiva espressa (7.1); 8. Garanzia (8.1 - 8.2 - 8.3 - 8.4 - 8.5 - 8.6 - 8.7); 9. Riserva di Proprietà (9.1); 10. Cessione del Contratto (10.1); 12. Legge applicabile e foro competente (12.1 - 12.2 - 12.3); 13 Clausole finali (13.1 - 13.2), e di approvarle specificamente

Le presenti condizioni generali risultano pubblicate sul sito Internet di LUXOR (luxor.it) dove possono essere consultate prendendone così piena e adeguata cognizione, ai sensi e per gli effetti dell'articolo 1341 e 1342 c.c.

VALIDITÀ DEL CATALOGO

I dati e gli elementi illustrativi pubblicati su questo catalogo si intendono non impegnativi. La società Luxor SpA si riserva il diritto, fermo restando le caratteristiche essenziali dei prodotti descritti, di apportare in ogni momento le eventuali modifiche che ritenesse necessarie o utili per motivi tecnici o commerciali.



LUXOR SPA

LEGAL OFFICE: Via Zanardelli, 88 - 25013 Carpenedolo (BS) Italy

ADMINISTRATIVE OFFICE, FACTORY AND COMMERCIAL OFFICE:

Via Madonnina, 94 - 25018 Montichiari (BS) Italy

Tel. +39 030 9961161 - Fax +39 030 9961165 - info@luxor.it

www.luxor.it