



LUXOR®

GENERAL CATALOGUE
HEATING LINE

2024.1



60 YEARS OF ITALIAN TRADITION

Luxor is an important industrial reality, world wide and European market leader in the production of flexible hoses and components for hydro and thermo-sanitary installations. Luxor has been the expression of the most prestigious made in Italy and the great Italian high technology mechanical workings tradition for fifty years; a quality certified and recognized by the most prestigious International Certification Institutes all over the world.

Our mission is the complete customer satisfaction through a process of continuous technological research in order to make high quality, reliable products, anticipating the market evolutions by innovative partnership with both customers and suppliers. Luxor mission takes

place in its own Research and Development Centre in which new and advanced technologies are constantly analyzed and researched with continuous investments to offer the most innovative and reliable solutions for the international markets at competitive costs, ensuring strict quality controls on each single piece.

Luxor entirely plans and realizes each product, thanks to its decennial know how. The great production strength, a "slender" innovative and advanced industrial organization together with a modern logistic conception, make Luxor able to satisfy every kind of request, even customized, with fast deliveries all over the world.



Luxor is certified ISO 9001:2015 by DEKRA Group certification body

CERTIFICATION





Please contact our offices for information about technical specifications and certified products or visit the website of the corresponding certification body for the latter.

Please refer to www.nsf.org for a complete list of NSF approved products.
Please refer to www.iapmort.org for a complete list of UPC/CUPC approved products.

1 RADIATOR VALVES







1.1 / EASY

Valves and Lockshields

	Connection for iron pipe	8		Connection for copper and plastic pipe W24x19	10		Connection for copper and plastic pipe G3/4 eurokonus	12
---	--------------------------	---	---	---	----	---	---	----

1.2 / THERMOTEKNA

Valves and Thermostatic Heads

	Thermostatic kit: Connection for iron pipe	22		Thermostatic kit: connection for copper and plastic pipe W24x19	23		Thermostatic kit: connection for copper and plastic pipe G3/4 eurokonus	24
	Connection for iron pipe	25		Connection for copper and plastic pipe W24x19	28		Connection for copper and plastic pipe G3/4 eurokonus	31
	Thermostatic Heads	38						

1.3 / 30 SERIES

Valves

	Radiator valves	51
---	-----------------	----







1.4 / 50th SERIES

Radiator valves

	Thermostatic kit: connection for copper and plastic pipe G3/4 eurokonus	60		Manual kit: connection for copper and plastic pipe G3/4 eurokonus	63		Thermostatisable valves with pre-regulation	65
	Manual valves: connection for copper and plastic pipe G3/4 eurokonus	68		Single/double pipe valves	70		Thermostatic head with integrated control and sensor	71

1.5 / M-MT

Valves and distributors

	4-way manual valves for single pipe distribution system	79		4-way thermostatic valves for single pipe distribution system	83		Valves for single/double pipe distribution system	86
	4-way distributors for single/double pipe distribution system	92		Coaxial valves	97		Single/double pipe system distributors for heating body	99

1.A / ACCESSORIES

	Accessories for valves, lockshields, 4-way valves and distributors	104
---	--	-----

2 MANIFOLDS



2.1 / CP SERIES

Simple manifolds

	Simple modular manifolds	111		Simple modular manifolds with shut-off valves	118		Replacements	121
	Simple modular manifolds with automatic alignment and shut-off valves	125		Replacements	128			

2.2 / CV SERIES

Modular manifolds with front valves

	Modular manifolds with front valves	135		Replacements	137			
---	-------------------------------------	-----	---	--------------	-----	--	--	--

2.3 / CC SERIES

Coplanar manifolds

	Coplanar manifolds	141						
--	--------------------	-----	--	--	--	--	--	--

2.4 / CD SERIES

Distribution manifolds



	Distribution manifolds for heating systems	149		Pre-assembled manifolds with installation accessories	172			
---	--	-----	---	---	-----	--	--	--

2.5 / CX SERIES



Stainless steel distribution manifolds

	Stainless steel distribution manifolds	188		Pre-assembled stainless steel distribution manifolds with installation accessories	192		Multipurpose water inlet ball valve	195
---	--	-----	---	--	-----	---	-------------------------------------	-----







2.A / ACCESSORIES

	Thermostatic heads	200		Accessories for distribution manifolds	201			
---	--------------------	-----	---	--	-----	--	--	--

3 VALVES

	Ball valves	222		Bypass valves for heating systems	227		Air vent valves	228
	Relief valves	231		Mixing valve	233		Diverting zone valves	236
	Magnetic dirt separator for heating system	238						

4 PREASSEMBLED GROUPS

	Pumping and mixing groups	240		Regulation systems for radiant panels heating with pump group GP 1190	243		Regulation system with pump group GP 1190 and kit for high temperature KA 1191	248
	Regulation system with pump group GP 1190 and kit for high temperature FM 750	254		Regulation systems for radiant panels heating with mixing Group GM 1192	259		Solar pump group	265

5 ELECTRICAL AND ELECTRONIC ACCESSORIES

	Thermoelectric heads	275		Contact or immersion safety thermostats	282		Circulation pump	286
	Servomotors	288		Actuator for room temperature control	291			

6 MODULAR HYDRONIC SYSTEM

	Manifolds	300		Pumping groups	302		Fixed point group	304
	Sliding point group	306		Accessories for distribution manifolds	310		Insulation	311

7 FITTINGS

	Fittings for copper pipe	317		Fittings for polyethylene, polybutylene and polypropylene pipe	318		Fittings for polyethylene multilayers PEX-AL-PEX pipe	319
	Chrome compression fittings	320		In-wall connections for the distribution with removable pipes	325		Fitting for copper, plastic and multilayer pipe	326



LUXOR®

RADIATOR VALVES

1.1 / EASY

EASY VALVES AND LOCKSHIELDS



When in closed position, the tightness is granted by an o-ring and a conical metal collar. The valves are nickel plated. Valves and lockshields must be opened with a differential pressure lower than 1 bar.



When in closed position, the tightness is granted by an o-ring and a conical metal collar. The valves are nickel plated. The flow can be adjusted by limiting the lift of the obturator.

TECHNICAL DATA



DN
10
15
20



Max temperature
120 °C



Max pressure
10 bar



Max differential pressure
1 bar



Materials
CW617N
UNI EN
12165:2016



Knob
white ABS
RAL 9016



Testing
100%

SYSTEM CONNECTIONS



Iron pipe
G 3/8
G 1/2
G 3/4

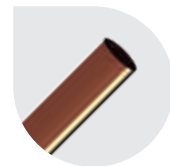

Copper pipe
W 24x19 - TR 91
G 3/4 EK - TR 91/A



Plastic pipe
W 24x19 - TP 95
G 3/4 EK - TP 98



Multilayer pipe
W 24x19 - TP 97
G 3/4 EK - TP 99

RADIATOR CONNECTION



Conical milled thread
G 3/8
G 1/2
G 3/4



Cylindrical thread with soft sealing
G 3/8
G 1/2
G 3/4

ADVANTAGES OF THE STEM MADE IN TWO PIECES

The hydraulic seal on the fixed rod is guaranteed by a double o-Ring.

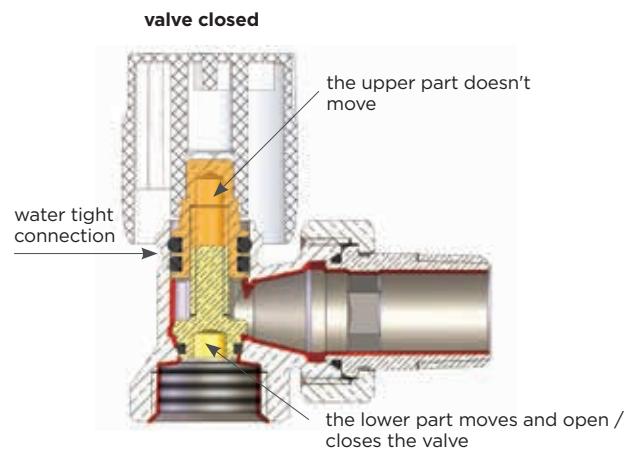
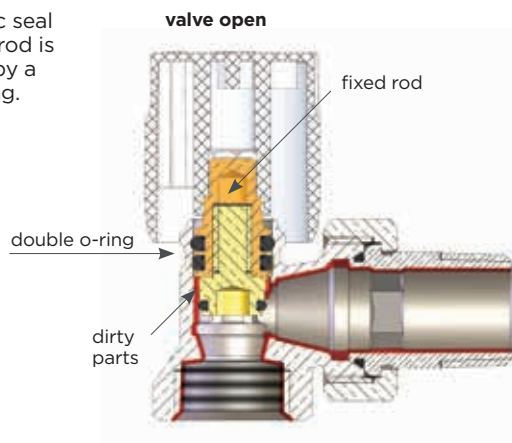

All valves and lockshields are 100% checked with an electronically controlled pneumatic test.

The characteristics of the fluid in the system must be compliant with the UNI 8065: 2019 directive.

ADVANTAGES OF THE STEM MADE IN TWO PIECES

TWO PIECES STEM

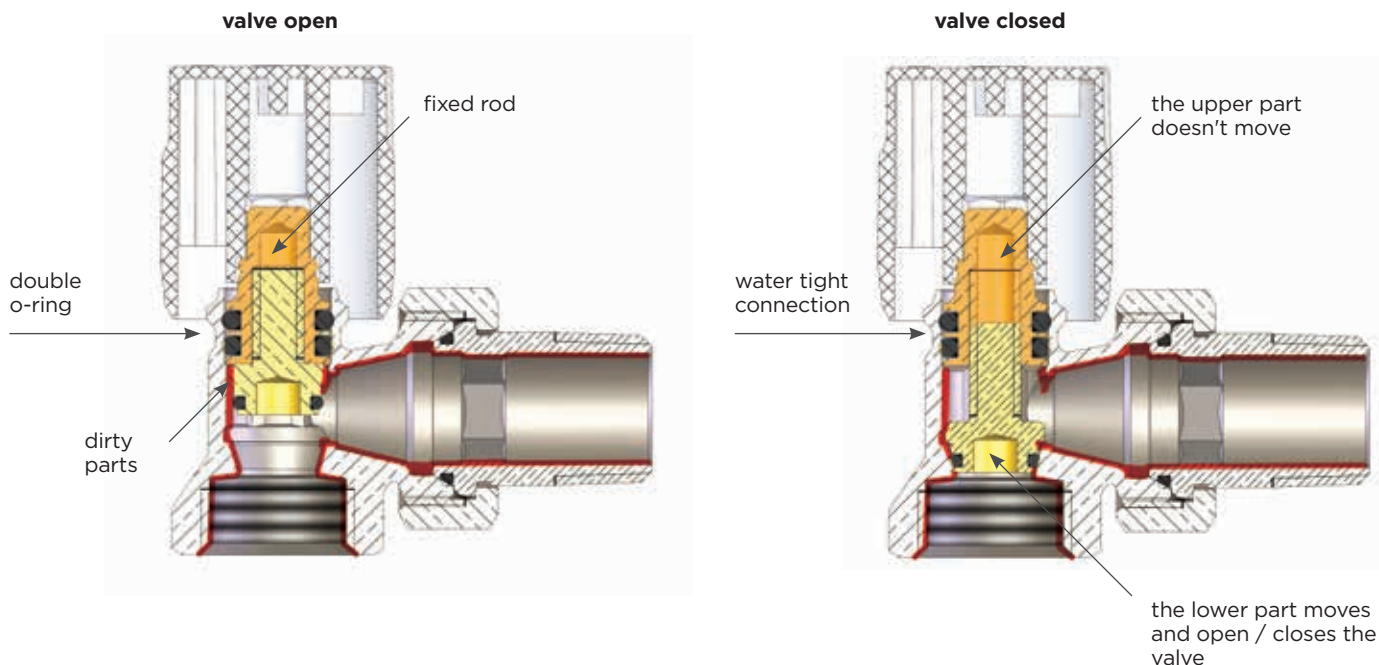

ONE PIECE STEM

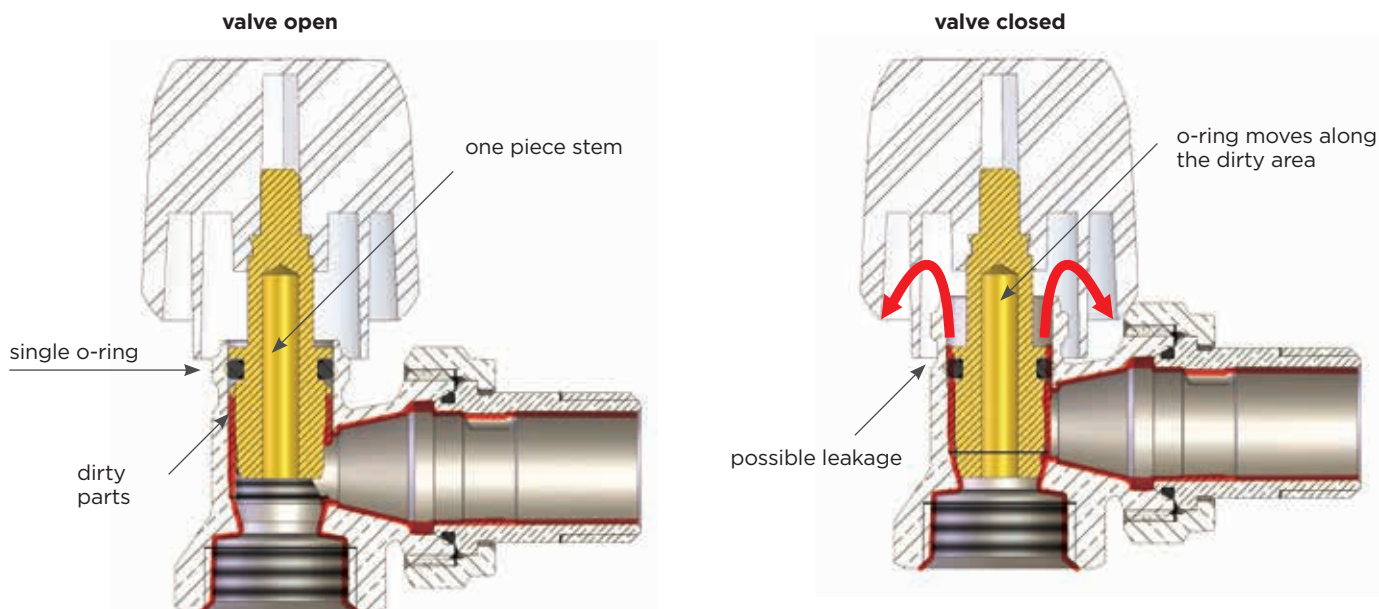

The benefit of the rod made in two pieces are many and occur both with the valve open and with the valve closed. The fixed rod, with double o-ring, guarantees the seal and prevents impurities from settling in the seat where these gaskets work, avoiding the decrease in their effectiveness.

In the sliding rod, however, this considerable benefit is not guaranteed as the working surface of the gaskets is exposed to the impurities of the fluid in the system. This can greatly increase the possibility of fluid loss, especially in the medium to long term.

CONNECTION FOR IRON PIPE

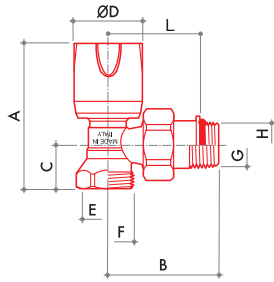

RS 102

Single adjustment angle radiator valve. Connection for iron pipe.

Fittings



CODE	SIZE	A	B	C	D	E	F	G	H	L			
11021700	DN 10 3/8	65	49	18	32	G 3/8	-	R 3/8	-	-	137	10	80
11022100	DN 15 1/2	67	51	20	32	G 1/2	-	R 1/2	-	-	170	10	80
11022700	DN 20 3/4	70	61	25	32	G 3/4	-	R 3/4	-	-	254	8	64

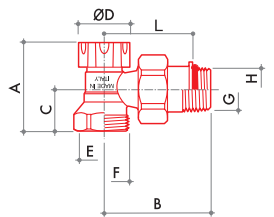

DS 122

Angle regulating lockshield. Connection for iron pipe.

Fittings



CODE	SIZE	A	B	C	D	E	F	G	H	L			
11061700	DN 10 3/8	40	49	18	25	G 3/8	-	R 3/8	-	-	121	10	80
11062100	DN 15 1/2	42	51	20	25	G 1/2	-	R 1/2	-	-	154	10	80
11062700	DN 20 3/4	47	61	25	25	G 3/4	-	R 3/4	-	-	238	8	64

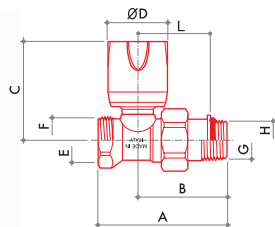

RD 101

Single adjustment straight radiator valve. Connection for iron pipe.

Fittings



CODE	SIZE	A	B	C	D	E	F	G	H	L			
11221700	DN 10 3/8	65	45	53	32	G 3/8	-	R 3/8	-	-	142	10	80
11222100	DN 15 1/2	68	47	53	32	G 1/2	-	R 1/2	-	-	176	10	80
11222700	DN 20 3/4	80	56	55	32	G 3/4	-	R 3/4	-	-	265	8	64

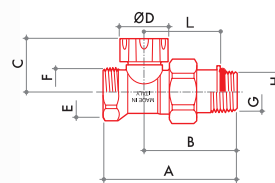

DD 121

Straight regulating lockshield. Connection for iron pipe.

Fittings



CODE	SIZE	A	B	C	D	E	F	G	H	L			
11261700	DN 10 3/8	65	45	28	25	G 3/8	-	R 3/8	-	-	132	10	80
11262100	DN 15 1/2	68	47	28	25	G 1/2	-	R 1/2	-	-	161	10	80
11262700	DN 20 3/4	80	56	29	25	G 3/4	-	R 3/4	-	-	248	8	64

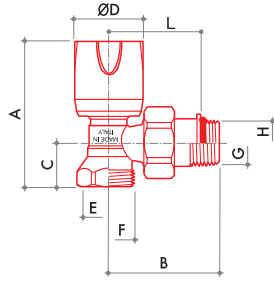

RS 106

Single adjustment angle radiator valve.
Connection for iron pipe.

Fittings



CODE	SIZE	A	B	C	D	E	F	G	H	L			
11022117	DN 10 3/8	65	46	18	32	G 3/8	-	-	G 3/8	36	143	10	80
11022103	DN 15 1/2	65	47	20	32	G 1/2	-	-	G 1/2	37	174	10	80
11022703	DN 20 3/4	70	58	25	32	G 3/4	-	-	G 3/4	46	257	8	64

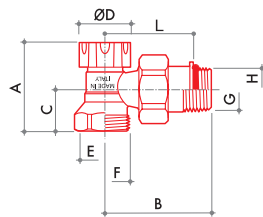

DS 126

Angle regulating lockshield.
Connection for iron pipe.

Fittings



CODE	SIZE	A	B	C	D	E	F	G	H	L			
11062117	DN 10 3/8	40	46	18	25	G 3/8	-	-	G 3/8	36	127	10	80
11062103	DN 15 1/2	42	47	20	25	G 1/2	-	-	G 1/2	37	158	10	80
11062703	DN 20 3/4	47	59	25	25	G 3/4	-	-	G 3/4	47	241	8	64

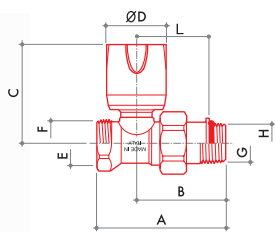

RD 105

Single adjustment straight radiator valve.
Connection for iron pipe.

Fittings



CODE	SIZE	A	B	C	D	E	F	G	H	L			
11222117	DN 10 3/8	62	42	53	32	G 3/8	-	-	G 3/8	32	148	10	80
11222103	DN 15 1/2	64	43	53	32	G 1/2	-	-	G 1/2	33	180	10	80
11222703	DN 20 3/4	77	53	55	32	G 3/4	-	-	G 3/4	41	268	8	64

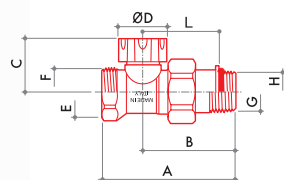

DD 125

Straight regulating lockshield.
Connection for iron pipe.

Fittings



CODE	SIZE	A	B	C	D	E	F	G	H	L			
11262117	DN 10 3/8	62	42	28	25	G 3/8	-	-	G 3/8	32	138	10	80
11262103	DN 15 1/2	64	43	28	25	G 1/2	-	-	G 1/2	33	165	10	80
11262703	DN 20 3/4	78	54	29	35	G 3/4	-	-	G 3/4	42	251	8	64

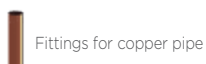

Fittings for copper pipe

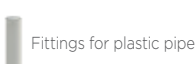

Fittings for plastic pipe

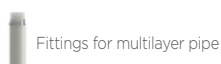

Fittings for multilayer pipe

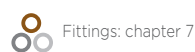

Fittings: chapter 7



Accessories: chapter 1.A

CONNECTION FOR COPPER AND PLASTIC PIPE W24X19

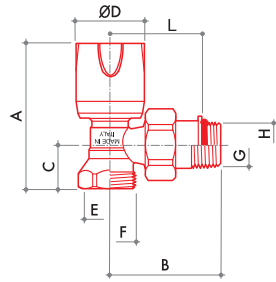

RS 112

Single adjustment angle radiator valve. Connection for copper and plastic pipe.

Fittings



CODE	SIZE	A	B	C	D	E	F	G	H	L			
11121700	DN 10 3/8	67	49	20	32	-	W24x19	R 3/8	-	-	138	10	80
11122100	DN 15 1/2	66	51	20	32	-	W24x19	R 1/2	-	-	159	10	80

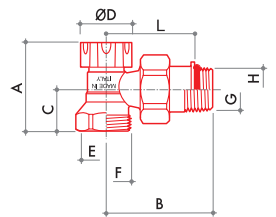

DS 132

Angle regulating lockshield. Connection for copper and plastic pipe.

Fittings



CODE	SIZE	A	B	C	D	E	F	G	H	L			
11161700	DN 10 3/8	42	49	20	25	-	W24x19	R 3/8	-	-	122	10	80
11162100	DN 15 1/2	42	51	20	25	-	W24x19	R 1/2	-	-	143	10	80

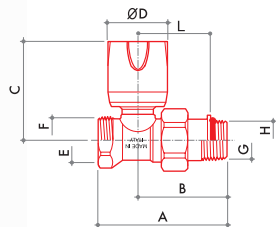

RD 111

Single adjustment straight radiator valve. Connection for copper and plastic pipe.

Fittings



CODE	SIZE	A	B	C	D	E	F	G	H	L			
11321700	DN 10 3/8	65	45	53	32	-	W24x19	R 3/8	-	-	144	10	80
11322100	DN 15 1/2	68	47	53	32	-	W24x19	R 1/2	-	-	165	10	80

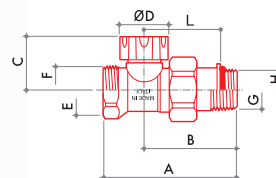

DD 131

Straight regulating lockshield. Connection for copper and plastic pipe.

Fittings

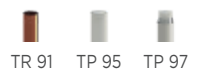

CODE	SIZE	A	B	C	D	E	F	G	H	L			
11361700	DN 10 3/8	65	45	28	25	-	W24x19	R 3/8	-	-	133	10	80
11362100	DN 15 1/2	68	47	27	25	-	W24x19	R 1/2	-	-	150	10	80

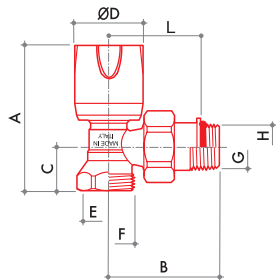

RS 119

Single adjustment angle radiator valve. Connection for copper and plastic pipe.

Fittings



CODE	SIZE	A	B	C	D	E	F	G	H	L			
11122117	DN 10 3/8	67	46	20	32	-	W24x19	-	G 3/8	36	148	10	80
11122103	DN 15 1/2	66	47	20	32	-	W24x19	-	G 1/2	37	162	10	80

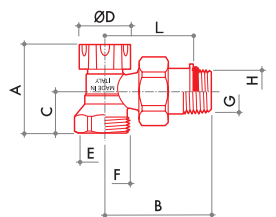

DS 139

Angle regulating lockshield. Connection for copper and plastic pipe.

Fittings



CODE	SIZE	A	B	C	D	E	F	G	H	L			
11162117	DN 10 3/8	42	46	20	25	-	W24x19	-	G 3/8	36	132	10	80
11162103	DN 15 1/2	42	47	20	25	-	W24x19	-	G 1/2	37	145	10	80

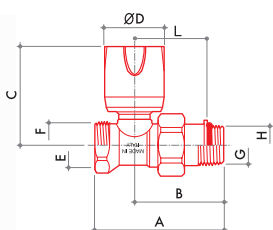

RD 118

Single adjustment straight radiator valve. Connection for copper and plastic pipe.

Fittings



CODE	SIZE	A	B	C	D	E	F	G	H	L			
11322117	DN 10 3/8	63	42	53	32	-	W24x19	-	G 3/8	32	152	10	80
11322103	DN 15 1/2	64	43	53	32	-	W24x19	-	G 1/2	33	171	10	80

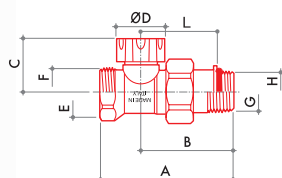

DD 138

Straight regulating lockshield. Connection for copper and plastic pipe.

Fittings



CODE	SIZE	A	B	C	D	E	F	G	H	L			
11362117	DN 10 3/8	63	42	28	25	-	W24x19	-	G 3/8	32	142	10	80
11362103	DN 15 1/2	64	43	27	25	-	W24x19	-	G 1/2	33	161	10	80



Fittings for copper pipe



Fittings for plastic pipe



Fittings for multilayer pipe



Fittings: chapter 7



Accessories: chapter 1.A

CONNECTION FOR COPPER AND PLASTIC PIPE G3/4 EUROKONUS

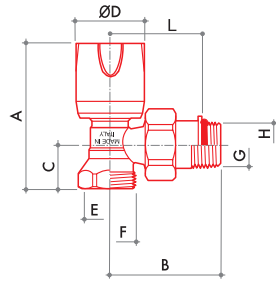

RS 112/A

Single adjustment angle radiator valve. Connections eurokonus type.

Fittings



CODE	SIZE	A	B	C	D	E	F	G	H	L			
11122718	DN 10 3/8	65	49	20	32	-	G 3/4 EK	R 3/8	-	-	148	10	80
11122721	DN 15 1/2	66	51	20	32	-	G 3/4 EK	R 1/2	-	-	161	10	80

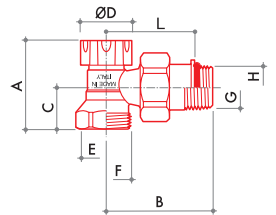

DS 132/A

Angle regulating lockshield. Connections eurokonus type.

Fittings



CODE	SIZE	A	B	C	D	E	F	G	H	L			
11162718	DN 10 3/8	42	49	20	25	-	G 3/4 EK	R 3/8	-	-	130	10	80
11162721	DN 15 1/2	42	51	20	25	-	G 3/4 EK	R 1/2	-	-	144	10	80

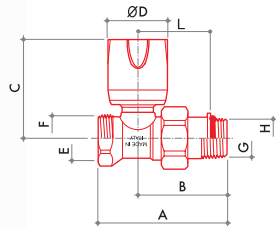

RD 111/A

Single adjustment straight radiator valve. Connections eurokonus type.

Fittings



CODE	SIZE	A	B	C	D	E	F	G	H	L			
11322719	DN 10 3/8	66	45	53	32	-	G 3/4 EK	R 3/8	-	-	149	10	80
11322722	DN 15 1/2	69	48	53	32	-	G 3/4 EK	R 1/2	-	-	170	10	80

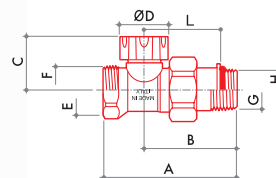

DD 131/A

Straight regulating lockshield. Connections eurokonus type.

Fittings



CODE	SIZE	A	B	C	D	E	F	G	H	L			
11362719	DN 10 3/8	66	45	28	25	-	G 3/4 EK	R 3/8	-	-	138	10	80
11362722	DN 15 1/2	69	48	28	25	-	G 3/4 EK	R 1/2	-	-	160	10	80

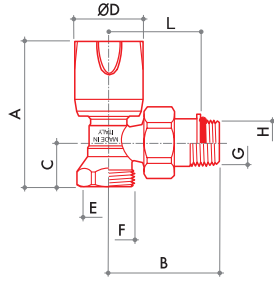

RS 119/A

Single adjustment angle radiator valve.
Connections eurokonus type.

Fittings



CODE	SIZE	A	B	C	D	E	F	G	H	L			
11122717	DN 10 3/8	66	46	20	32	-	G 3/4 EK	-	G 3/8	36	151	10	80
11122703	DN 15 1/2	66	47	20	32	-	G 3/4 EK	-	G 1/2	37	165	10	80

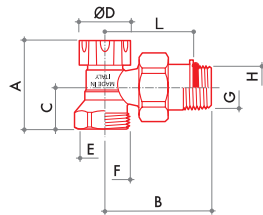

DS 139/A

Angle regulating lockshield.
Connections eurokonus type.

Fittings



CODE	SIZE	A	B	C	D	E	F	G	H	L			
11162717	DN 10 3/8	42	46	20	25	-	G 3/4 EK	-	G 3/8	36	135	10	80
11162703	DN 15 1/2	42	47	20	25	-	G 3/4 EK	-	G 1/2	37	148	10	80

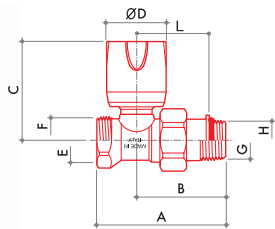

RD 118/A

Single adjustment straight radiator valve. Connections eurokonus type.

Fittings



CODE	SIZE	A	B	C	D	E	F	G	H	L			
11322717	DN 10 3/8	63	42	53	32	-	G 3/4 EK	-	G 3/8	32	155	10	80
11322703	DN 15 1/2	64	43	53	32	-	G 3/4 EK	-	G 1/2	33	174	10	80

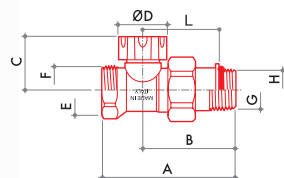

DD 138/A

Straight lockshield regulating valve. Connections eurokonus type.

Fittings



CODE	SIZE	A	B	C	D	E	F	G	H	L			
11362717	DN 10 3/8	63	42	28	25	-	G 3/4 EK	-	G 3/8	32	145	10	80
11362703	DN 15 1/2	64	43	27	25	-	G 3/4 EK	-	G 1/2	33	164	10	80



Fittings for copper pipe



Fittings for plastic pipe



Fittings for multilayer pipe



Fittings: chapter 7



Accessories: chapter 1.A

VALVES FLOW RATE CHART

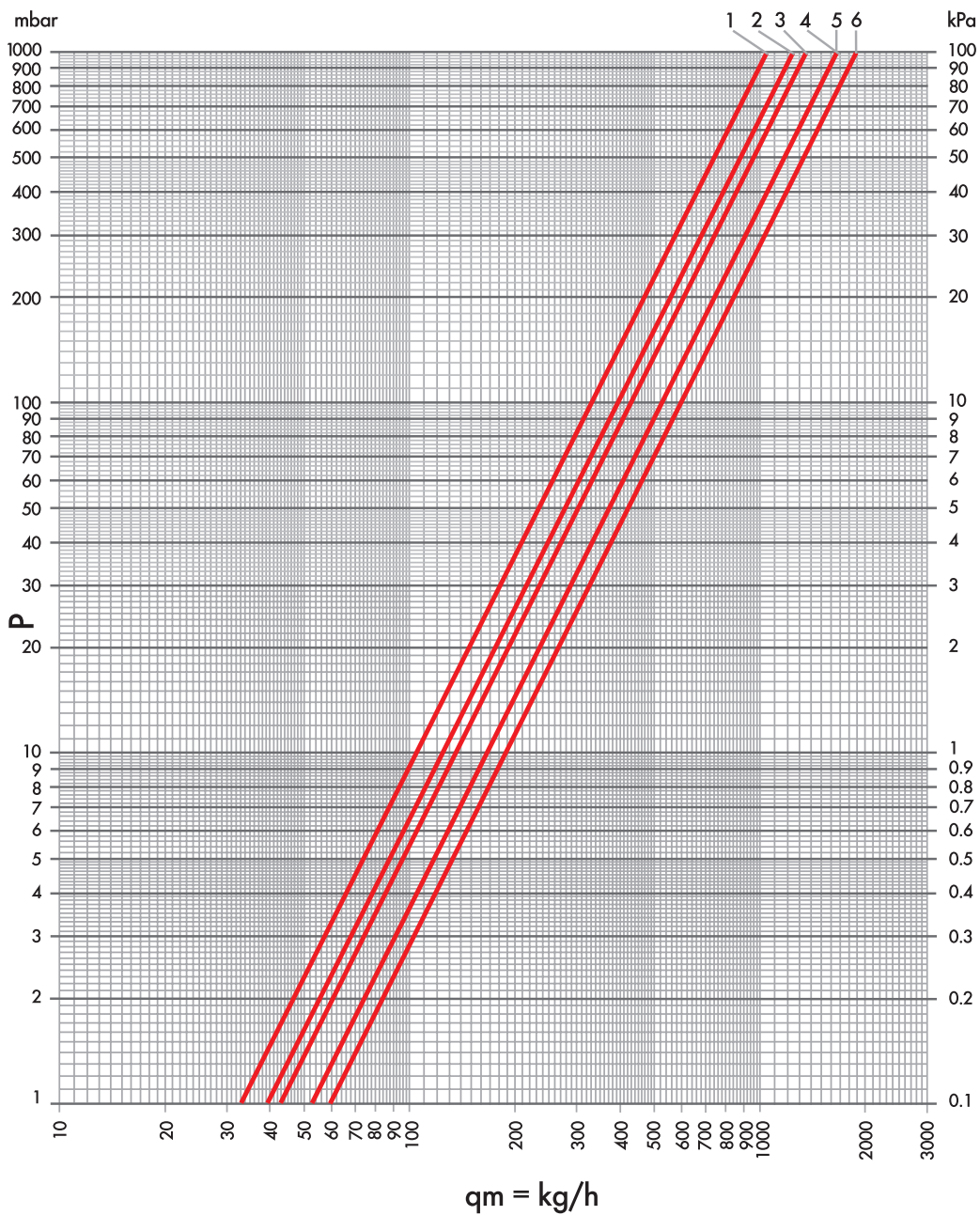

ITEM	Kv	POS
RD 101 3/8 - RD 105 3/8 - RD 111 3/8 RD 118 3/8 - RD 118/A 3/8	1.05	1
RD 101 1/2 - RD 105 1/2 - RD 111 1/2 RD 111/A 1/2 - RD 118 1/2 - RD 118/A 1/2	1.25	2
RD 101 3/4 - RD 105 3/4	1.35	3
RS 102 3/8 - RS 106 3/8 - RS 112 3/8 RS 119 3/8 - RS 119/A 3/8	1.65	4
RS 102 1/2 - RS 106 1/2 - RS 112 1/2 RS 112/A 1/2 - RS 119 1/2 - RS 119/A 1/2	1.65	5
RS 102 3/4 - RS 106 3/4	1.90	6

LOCKSHIELD FLOW RATE CHART

ANGLE LOCKSHIELD

DN 10 3/8 - DN 15 1/2

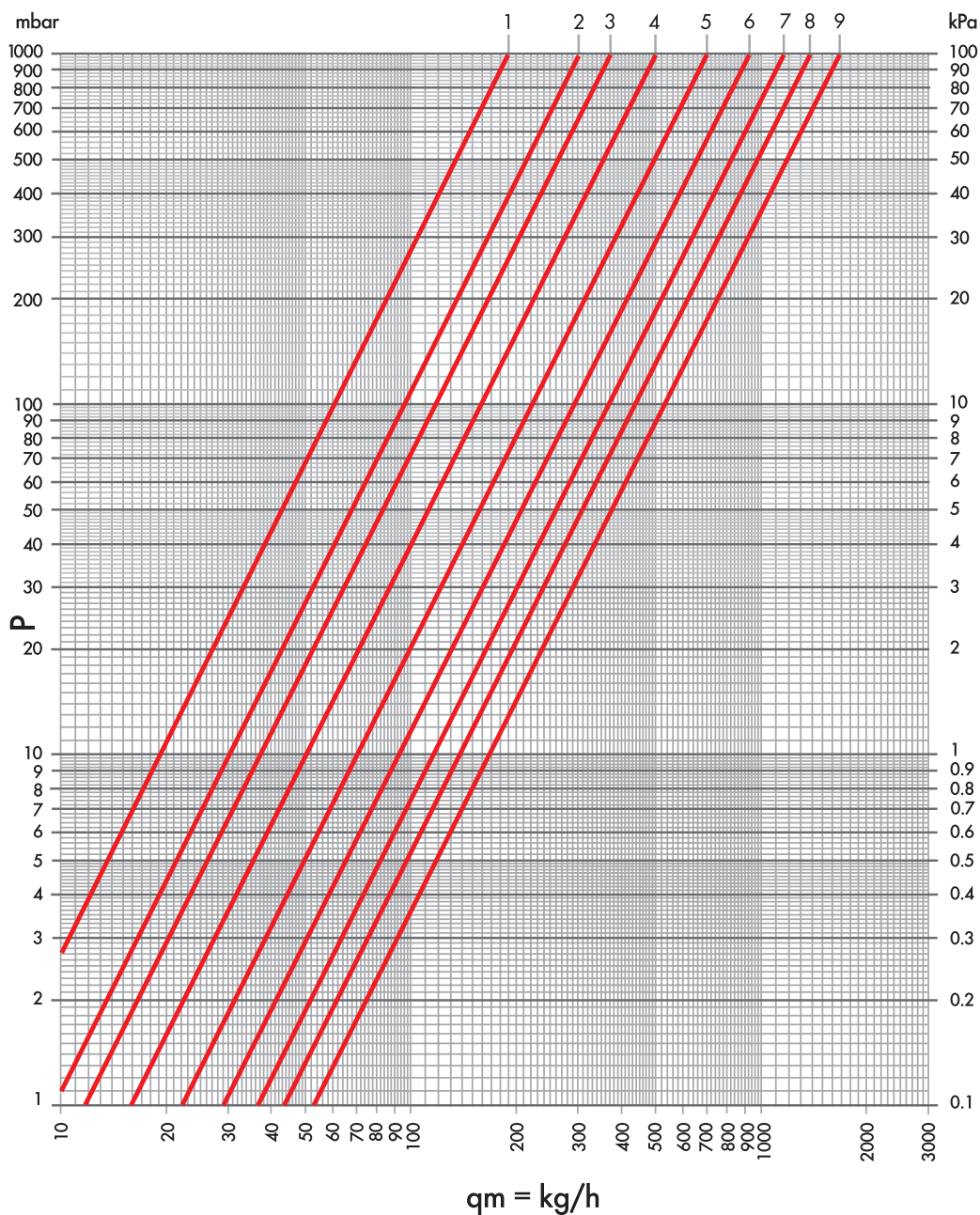

ITEM	TURNS N°	Kvs	POS
DS 122 DS 126 DS 132 DS 139 DS 132/A DS 139/A	1	0.19	1
	1+1/2	0.30	2
	2	0.37	3
	2+1/2	0.50	4
	3	0.69	5
	3+1/2	0.92	6
	4	1.14	7
	4+1/2	1.39	8
	all open	1.65	9

LOCKSHIELD FLOW RATE CHART

ANGLE LOCKSHIELD DN 20 3/4

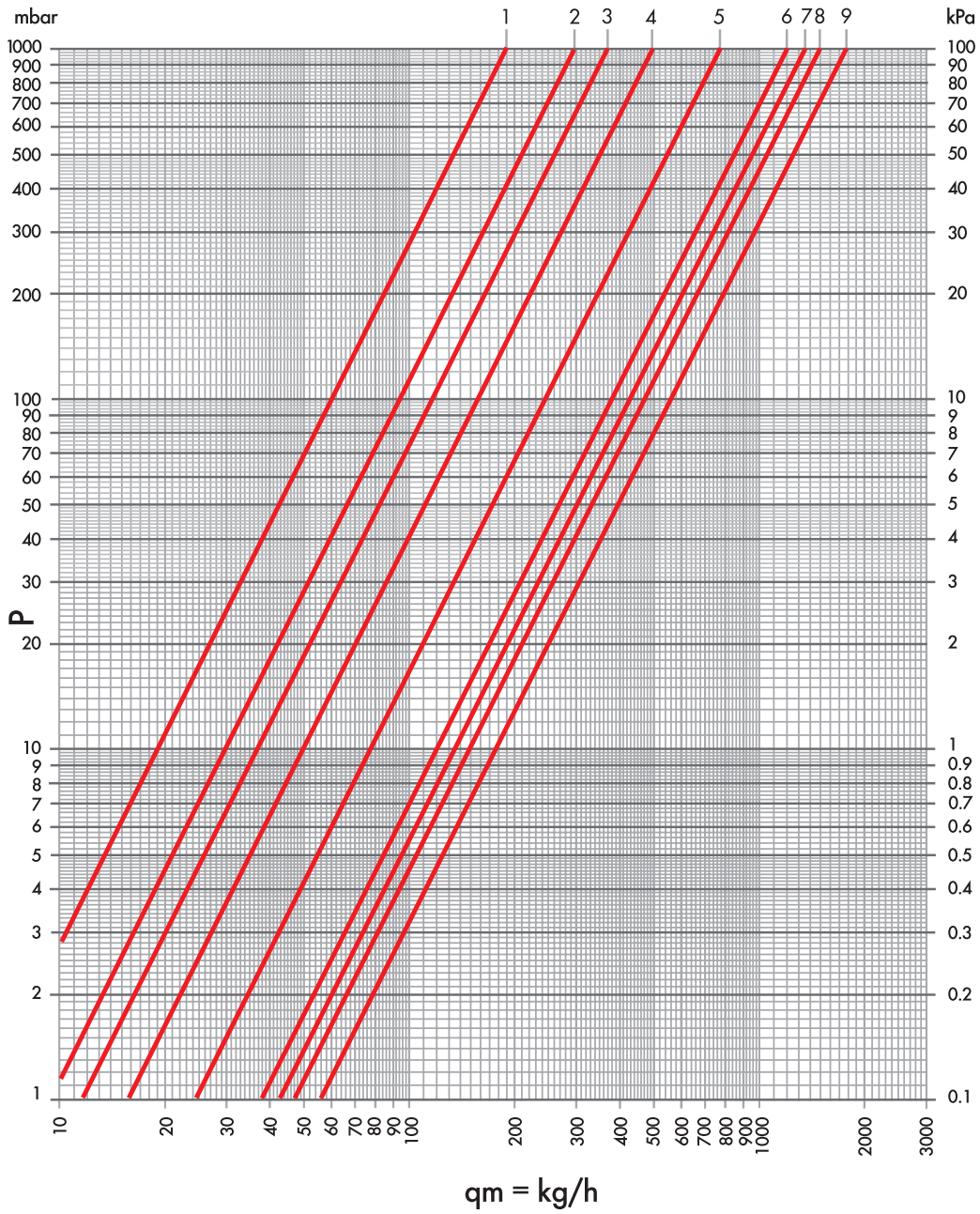

ITEM	TURNS N°	Kvs	POS
DS 122 DS 126 DS 132 DS 139 DS 132/A DS 139/A	1	0.19	1
	1+1/2	0.30	2
	2	0.37	3
	2+1/2	0.50	4
	3	0.78	5
	3+1/2	1.19	6
	4	1.34	7
	4+1/2	1.50	8
	all open	1.75	9

LOCKSHIELD FLOW RATE CHART

STRAIGHT LOCKSHIELD

DN 10 3/8 - DN 15 1/2

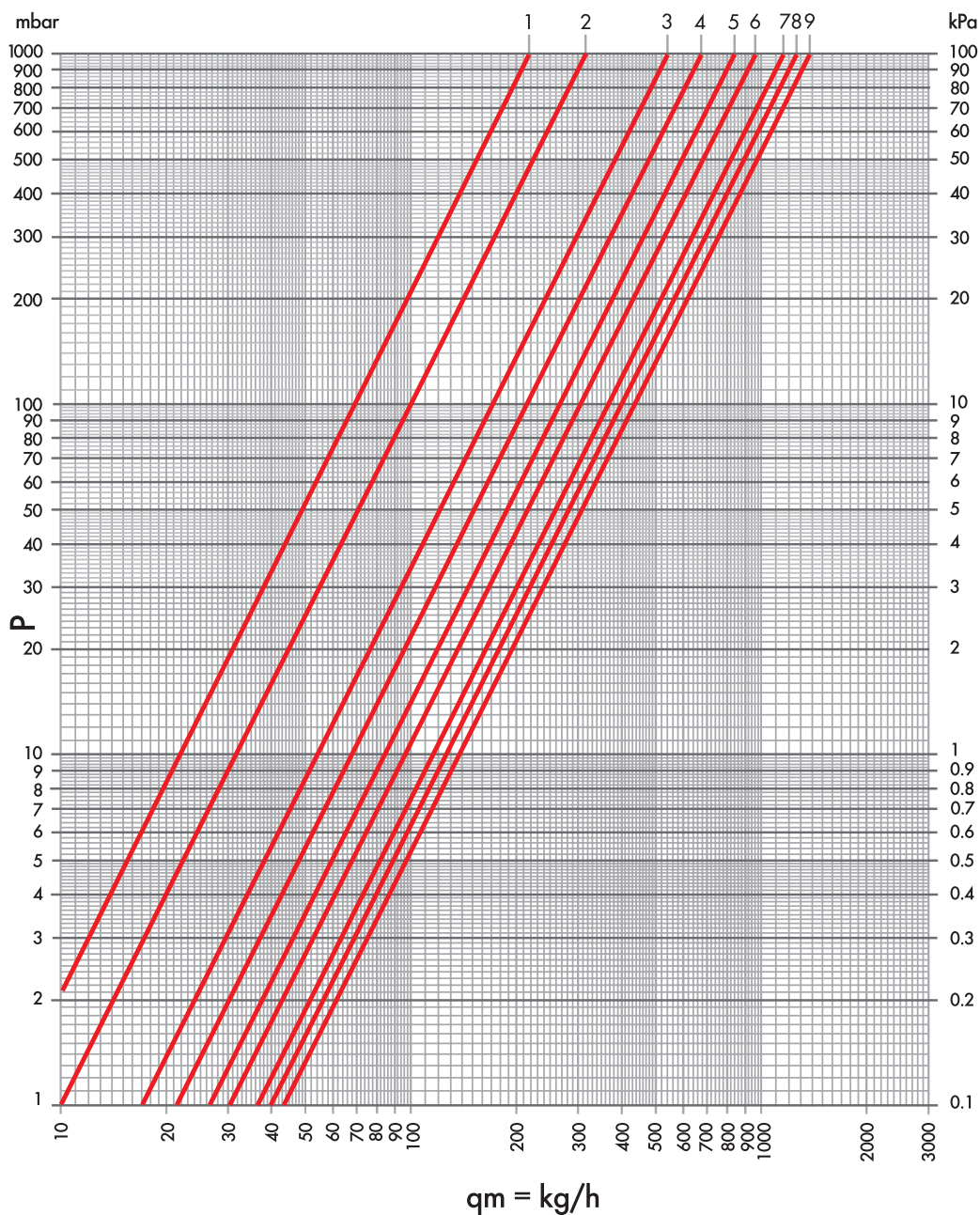

ITEM	TURNS N°	Kvs	POS
DD 121 DD 125 DD 131 DD 138 DD 131/A DD 138/A	1	0.22	1
	1+1/2	0.32	2
	2	0.53	3
	2+1/2	0.68	4
	3	0.84	5
	3+1/2	0.97	6
	4	1.14	7
	4+1/2	1.25	8
	all open	1.34	9

LOCKSHIELD FLOW RATE CHART

STRAIGHT LOCKSHIELD

DN 20 3/4

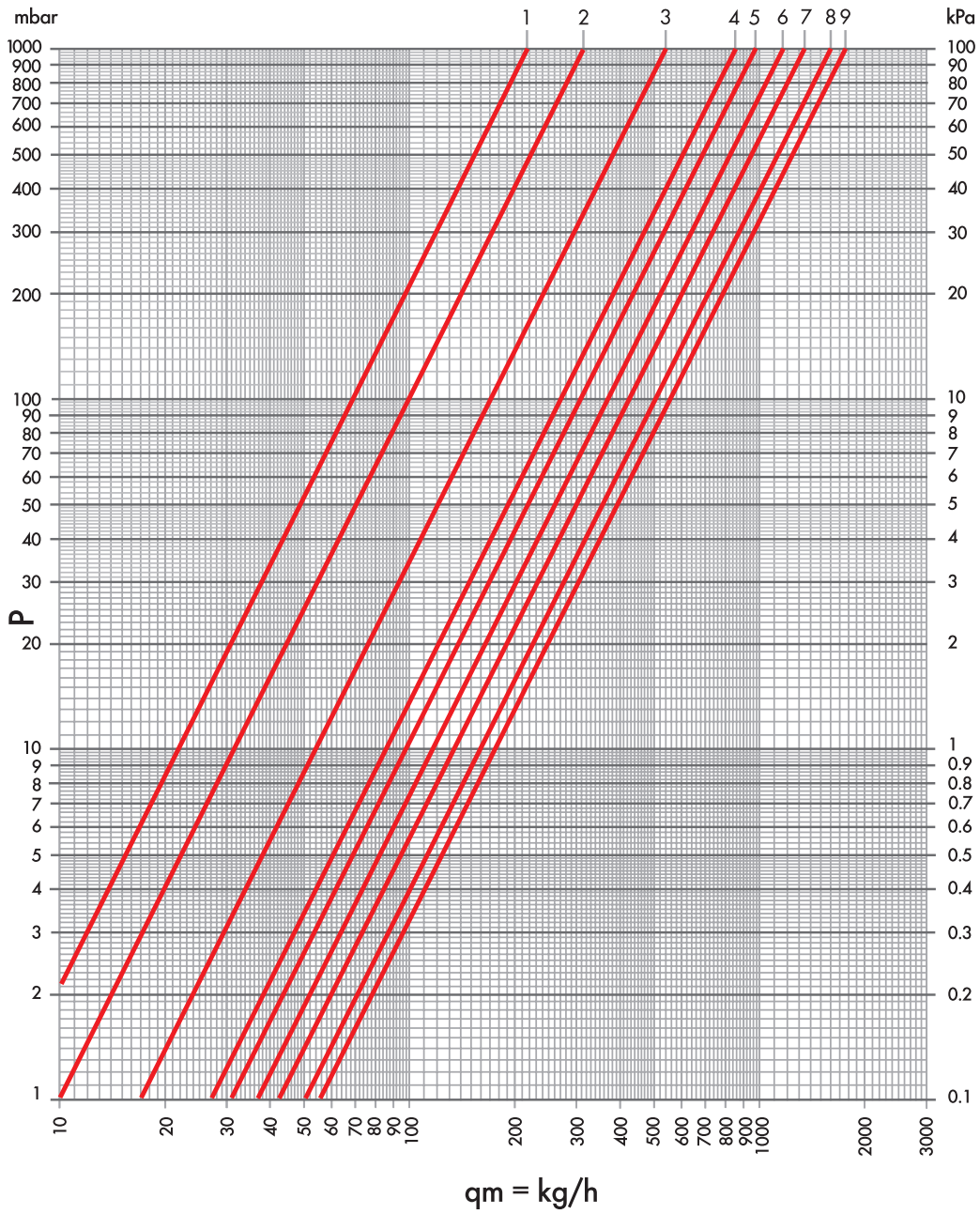

ITEM	TURNS N°	Kvs	POS
DD 121 DD 125 DD 131 DD 138 DD 131/A DD 138/A	1	0.22	1
	1+1/2	0.32	2
	2	0.54	3
	2+1/2	0.85	4
	3	0.97	5
	3+1/2	1.19	6
	4	1.34	7
	4+1/2	1.60	8
	all open	1.75	9



LUXOR®

RADIATOR VALVES

1.2 / THERMOTEKNA

THERMOTEKNA

THERMOSTATIC VALVE BODIES WITH PRE-REGULATION



* UNI EN 215
Approved

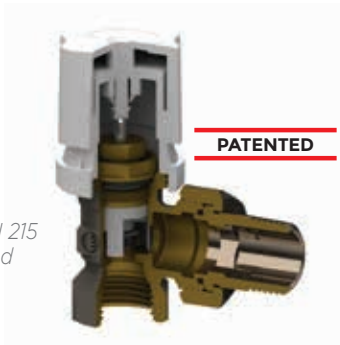

**REVERSE
FLOW**



The screw of ThermoTekna valves allows to preset the flow thanks to a shaped acetal ring. The thermostatic screw enables to replace one of the o-rings on the control stem without draining the system. The valves - where clearly indicated - are approved according to UNI EN 215. The valves are nickel plated. Valves and lockshields must be opened with a differential pressure lower than 1 bar.

The tightness of Tekna lockshields is ensured by an o-ring on the obturator and, if necessary, by a further o-ring between the body and the plug. When in closed position, the tightness is granted by an o-ring and a conical metal collar. The lockshields are nickel plated. The flow can be adjusted by limiting the lift of the obturator.

TECHNICAL DATA



DN

10
15
20



Max temperature

120 °C



Max pressure

10 bar



Max differential pressure
(thermostatic valves)

0,6 bar



Max differential pressure

1 bar



Materials

CW617N
UNI EN
12165:2016



Knob

white ABS
RAL 9016



Stem

AISI 316



Testing

100%

SYSTEM CONNECTIONS

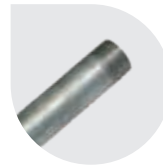

Iron pipe

G 3/8
G 1/2
G 3/4

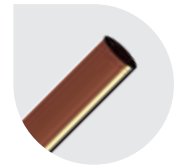

Copper pipe

W 24x19 - TR 91
G 3/4 EK - TR 91/A



Plastic pipe

W 24x19 - TP 95
G 3/4 EK - TP 98



Multilayer pipe

W 24x19 - TP 97
G 3/4 EK - TP 99

RADIATOR CONNECTION



**conical milled
thread**

G 3/8
G 1/2
G 3/4



**cylindrical thread
with soft sealing**

G 3/8
G 1/2
G 3/4

All valves and lockshields are 100% checked with an electronically controlled pneumatic test.

The characteristics of the fluid in the system must be compliant with the UNI 8065: 2019 directive.

FLOW ADJUSTMENT AND REVERSE FLOW

To adjust the maximum flow rate, proceed as follows:

- align the reference mark on the stainless steel stem with one of the positions marked on the valve.

Luxor thermostatic valves are now EN 215 approved in reverse flow mode as well.

This characteristic allows for installation on the inlet as well as on the outlet of the radiator up to a 0,6 bar differential pressure.

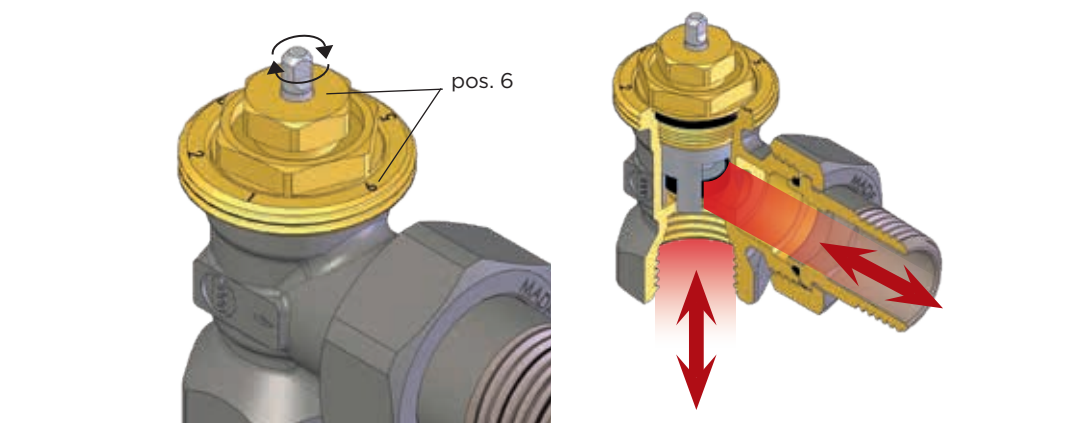
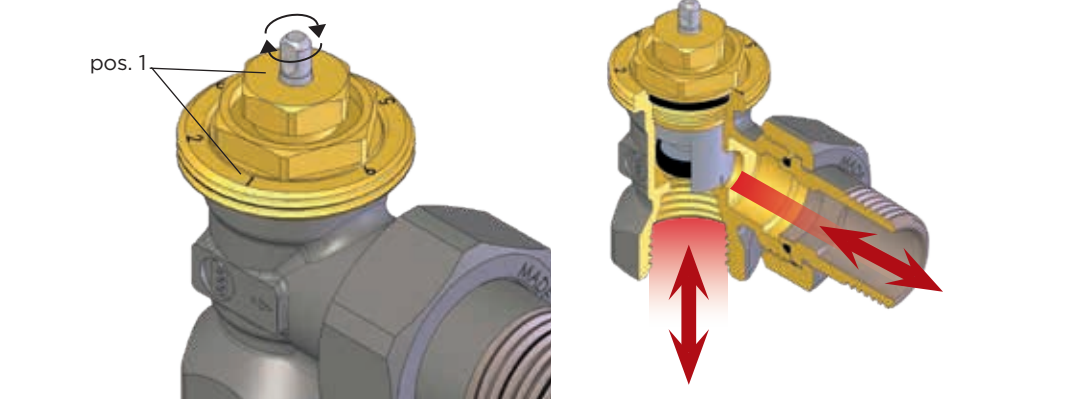

TIGHTNESS ON THE STEM

The tightening system can be easily replaced without draining the system:

- unscrew the hexagonal collar with a 13 mm wrench key;
- remove the o-ring "art. 582 - code 3424602", clean the stainless steel stem, insert a new o-ring "art. 582";
- assemble the collar screwing tight.









THERMOSTATIC KIT: CONNECTION FOR IRON PIPE



 * UNI EN 215
Approved

KT 202







Complete thermostatic kit for radiator connection. Equipped with RS 202 + DS 22 + TT 3000. Connection for iron pipe.

CODE	SIZE						
12821700	DN 10 3/8	-	-	-	436	1	32
12822100*	DN 15 1/2	TR 92	-	TP 90	521	1	32
12822700	DN 20 3/4	-	-	-	671	1	32



KT 201

Complete thermostatic kit for radiator connection. Equipped with RD 201 + DD 21 + TT 3000. Connection for iron pipe.







CODE	SIZE						
12901700	DN 10 3/8	-	-	-	473	1	32
12902100	DN 15 1/2	TR 92	-	TP 90	514	1	32
12902700	DN 20 3/4	-	-	-	685	1	32



 * UNI EN 215
Approved

KT 206







Complete thermostatic kit for radiator connection. Equipped with RS 206 + DS 26 + TT 3000. Connection for iron pipe.

CODE	SIZE						
12822117	DN 10 3/8	-	-	-	426	1	32
12822103*	DN 15 1/2	TR 92	-	TP 90	501	1	32
12822703	DN 20 3/4	-	-	-	636	1	32



KT 205

Complete thermostatic kit for radiator connection. Equipped with RD 205 + DD 25 + TT 3000. Connection for iron pipe.

CODE	SIZE						
12942117	DN 10 3/8	-	-	-	471	1	32
12942103	DN 15 1/2	TR 92	-	TP 90	536	1	32
12942703	DN 20 3/4	-	-	-	706	1	32





THERMOSTATIC KIT: CONNECTION FOR COPPER AND PLASTIC PIPE W24X19



* UNI EN 215
Approved

KT 212







Complete thermostatic kit for radiator connection. Equipped with RS 212 + DS 32 + TT 3000. Connection for copper and plastic pipe.

CODE	SIZE						
12841700*	DN 10 3/8	TR 91	TP 95	TP 97	424	1	32
12842100*	DN 15 1/2	TR 91	TP 95	TP 97	477	1	32



KT 211

Complete thermostatic kit for radiator connection. Equipped with RD 211 + DD 31 + TT 3000. Connection for copper and plastic pipe.





CODE	SIZE						
12861700	DN 10 3/8	TR 91	TP 95	TP 97	445	1	32
12862100	DN 15 1/2	TR 91	TP 95	TP 97	492	1	32



* UNI EN 215
Approved

KT 209







Complete thermostatic kit for radiator connection. Equipped with RS 209 + DS 39 + TT 3000. Connection for copper and plastic pipe.

CODE	SIZE						
12842117*	DN 10 3/8	TR 91	TP 95	TP 97	441	1	32
12842103*	DN 15 1/2	TR 91	TP 95	TP 97	484	1	32



KT 208

Complete thermostatic kit for radiator connection. Equipped with RD 208 + DD 38 + TT 3000. Connection for copper and plastic pipe.

CODE	SIZE						
12962117	DN 10 3/8	TR 91	TP 95	TP 97	348	1	32
12962103	DN 15 1/2	TR 91	TP 95	TP 97	381	1	32



Fittings for copper pipe



Fittings for plastic pipe



Fittings for multilayer pipe



Fittings: chapter 7



Accessories: chapter 1.A







THERMOSTATIC KIT: CONNECTION FOR COPPER AND PLASTIC PIPE G3/4 EUROKONUS



 * UNI EN 215
Approved

KT 212/A







Complete thermostatic kit for radiator connection. Equipped with RS 212/A + DS 32/A + TT 3000. Eurokonus connection.

CODE	SIZE						
12842718*	DN 10 3/8	TR 91/A	TP 98	TP 99	406	1	32
12842721*	DN 15 1/2	TR 91/A	TP 98	TP 99	483	1	32



KT 211/A

Complete thermostatic kit for radiator connection. Equipped with RD 211/A + DD 31/A + TT 3000. Eurokonus connection.







CODE	SIZE						
12862719	DN 10 3/8	TR 91/A	TP 98	TP 99	440	1	32
12862722	DN 15 1/2	TR 91/A	TP 98	TP 99	484	1	32



 * UNI EN 215
Approved

KT 209/A







Complete thermostatic kit for radiator connection. Equipped with RS 209/A + DS 39/A + TT 3000. Eurokonus connection.

CODE	SIZE						
12842717*	DN 10 3/8	TR 91/A	TP 98	TP 99	447	1	32
12842703*	DN 15 1/2	TR 91/A	TP 98	TP 99	484	1	32



KT 208/A

Complete thermostatic kit for radiator connection. Equipped with RD 208/A + DD 38/A + TT 3000. Eurokonus connection.

CODE	SIZE						
12962717	DN 10 3/8	TR 91/A	TP 98	TP 99	340	1	32
12962703	DN 15 1/2	TR 91/A	TP 98	TP 99	380	1	32



CONNECTION FOR IRON PIPE

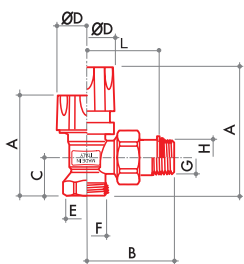

RS 202

Angle radiator valve, thermostatically or electronically controlled with protection cap. Connection for iron pipe.



Fittings

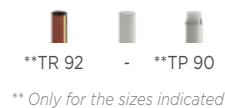

** Only for the sizes indicated

CODE	SIZE	A	B	C	D	E	F	G	H	L			
12021700	DN 10 3/8	58	50	20	37	G 3/8	-	R 3/8	-	-	156	10	80
12022100*	DN 15 1/2**	60	53	23	37	G 1/2	-	R 1/2	-	-	198	10	80
12022700	DN 20 3/4	60	62	27	37	G 3/4	-	R 3/4	-	-	264	8	64

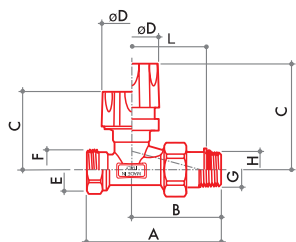

RD 201

Straight radiator valve, thermostatically or electronically controlled with protection cap. Connection for iron pipe.

Fittings

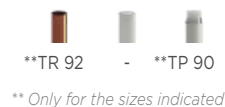

** Only for the sizes indicated

CODE	SIZE	A	B	C	D	E	F	G	H	L			
12221700	DN 10 3/8	76	51	46	37	G 3/8	-	R 3/8	-	-	177	10	80
12222100	DN 15 1/2**	83	55	46	37	G 1/2	-	R 1/2	-	-	216	10	80
12222700	DN 20 3/4	97	65	47	37	G 3/4	-	R 3/4	-	-	301	8	64

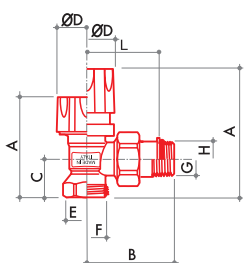

RS 206

Angle radiator valve, thermostatically or electronically controlled with protection cap. Connection for iron pipe.



Fittings

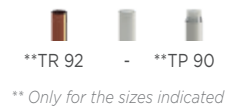

** Only for the sizes indicated

CODE	SIZE	A	B	C	D	E	F	G	H	L			
12022117	DN 10 3/8	58	47	20	37	G 3/8	-	-	G 3/8	37	164	10	80
12022103*	DN 15 1/2**	61	49	23	37	G 1/2	-	-	G 1/2	39	202	10	80
12022703	DN 20 3/4	60	60	27	37	G 3/4	-	-	G 3/4	48	267	8	64

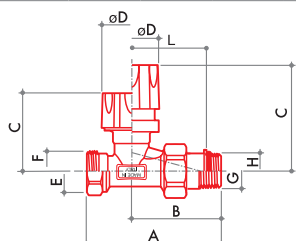

RD 205

Straight radiator valve, thermostatically or electronically controlled with protection cap. Connection for iron pipe.

Fittings

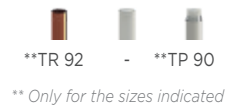

** Only for the sizes indicated

CODE	SIZE	A	B	C	D	E	F	G	H	L			
12222117	DN 10 3/8	73	48	46	37	G 3/8	-	-	G 3/8	38	185	10	80
12222103	DN 15 1/2**	78	51	46	37	G 1/2	-	-	G 1/2	40	220	10	80
12222703	DN 20 3/4	95	63	47	37	G 3/4	-	-	G 3/4	51	305	8	64



Fittings for copper pipe



Fittings for plastic pipe



Fittings for multilayer pipe



Fittings: chapter 7



Accessories: chapter 1.A

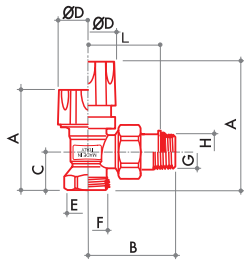

RS 2502

Angle radiator valve, thermostatically or electronically controlled, with manual control knob. Connection for iron pipe.



Fittings



** Only for the sizes indicated

CODE	SIZE	A	B	C	D	E	F	G	H	L			
12621700	DN 10 3/8	75	50	20	37	G 3/8	-	R 3/8	-	-	165	10	80
12622100*	DN 15 1/2**	78	53	23	37	G 1/2	-	R 1/2	-	-	201	10	80
12622700	DN 20 3/4	78	62	27	37	G 3/4	-	R 3/4	-	-	277	8	64

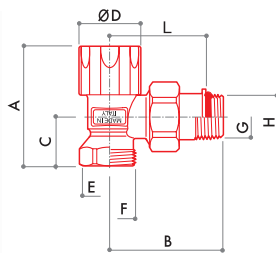

DS 22

Angle regulating lockshield. Connection for iron pipe.

Fittings



** Only for the sizes indicated

CODE	SIZE	A	B	C	D	E	F	G	H	L			
10061700	DN 10 3/8	53	50	20	30	G 3/8	-	R 3/8	-	-	132	10	80
10062100	DN 15 1/2**	57	54	23	30	G 1/2	-	R 1/2	-	-	170	10	80
10062700	DN 20 3/4	57	62	27	30	G 3/4	-	R 3/4	-	-	244	8	64

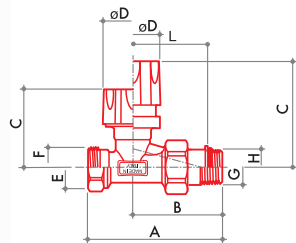

RD 2501

Straight radiator valve, thermostatically or electronically controlled, with manual control knob. Connection for iron pipe.

Fittings



** Only for the sizes indicated

CODE	SIZE	A	B	C	D	E	F	G	H	L			
12421700	DN 10 3/8	76	51	64	37	G 3/8	-	R 3/8	-	-	184	10	80
12422100	DN 15 1/2**	83	55	64	37	G 1/2	-	R 1/2	-	-	220	10	80
12422700	DN 20 3/4	97	65	65	37	G 3/4	-	R 3/4	-	-	309	8	64

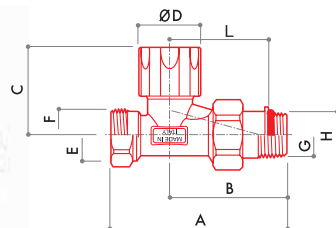

DD 21

Straight regulating lockshield. Connection for iron pipe.

Fittings



** Only for the sizes indicated

CODE	SIZE	A	B	C	D	E	F	G	H	L			
10261700	DN 10 3/8	76	51	41	30	G 3/8	-	R 3/8	-	-	153	10	80
10262100	DN 15 1/2**	83	55	42	30	G 1/2	-	R 1/2	-	-	187	10	80
10262700	DN 20 3/4	97	65	43	30	G 3/4	-	R 3/4	-	-	273	8	64

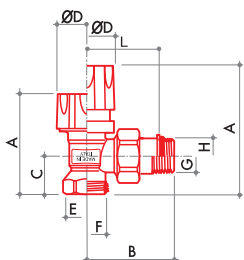

RS 2506

Angle radiator valve, thermostatically or electronically controlled, with manual control knob. Connection for iron pipe.



Fittings



** Only for the sizes indicated

CODE	SIZE	A	B	C	D	E	F	G	H	L			
12622117	DN 10 3/8	75	47	20	37	G 3/8	-	-	G 3/8	37	192	10	80
12622103*	DN 15 1/2**	78	49	23	37	G 1/2	-	-	G 1/2	39	224	10	80
12622703	DN 20 3/4	78	60	27	37	G 3/4	-	-	G 3/4	48	275	8	64

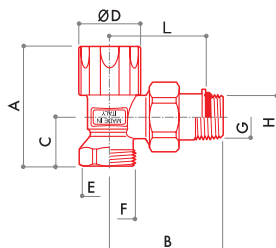

DS 26

Angle regulating lockshield. Connection for iron pipe.

Fittings



** Only for the sizes indicated

CODE	SIZE	A	B	C	D	E	F	G	H	L			
10062117	DN 10 3/8	53	47	20	30	G 3/8	-	-	G 3/8	37	138	10	80
10062103	DN 15 1/2**	57	50	23	30	G 1/2	-	-	G 1/2	39	174	10	80
10062703	DN 20 3/4	57	57	27	30	G 3/4	-	-	G 3/4	45	247	8	64

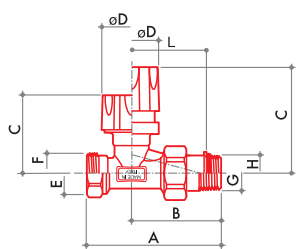

RD 2505

Straight radiator valve, thermostatically or electronically controlled, with manual control knob. Connection for iron pipe.

Fittings



** Only for the sizes indicated

CODE	SIZE	A	B	C	D	E	F	G	H	L			
12422117	DN 10 3/8	73	48	64	37	G 3/8	-	-	G 3/8	38	173	10	80
12422103	DN 15 1/2**	78	51	64	37	G 1/2	-	-	G 1/2	40	205	10	80
12422703	DN 20 3/4	95	63	65	37	G 3/4	-	-	G 3/4	51	290	8	64

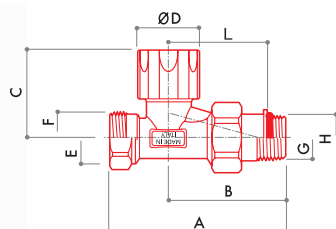

DD 25

Straight regulating lockshield. Connection for iron pipe.

Fittings



** Only for the sizes indicated

CODE	SIZE	A	B	C	D	E	F	G	H	L			
10262117	DN 10 3/8	73	48	41	30	G 3/8	-	-	G 3/8	38	159	10	80
10262103	DN 15 1/2**	78	51	42	30	G 1/2	-	-	G 1/2	40	191	10	80
10262703	DN 20 3/4	95	63	43	30	G 3/4	-	-	G 3/4	51	276	8	64

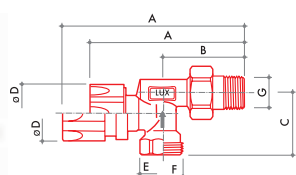

M 332

Reverse angle radiator valve, thermostatically or electronically controlled, with manual control knob. Connection for iron pipe.

Fittings



** Only for the sizes indicated

CODE	SIZE	A	B	C	D	E	F	G	H	L			
13222100	DN 15 1/2	116	52	40	35	G 1/2	-	R 1/2	-	-	228	10	80



Fittings for copper pipe



Fittings for plastic pipe



Fittings for multilayer pipe



Fittings: chapter 7



Accessories: chapter 1.A

CONNECTION FOR COPPER AND PLASTIC PIPE W24X19

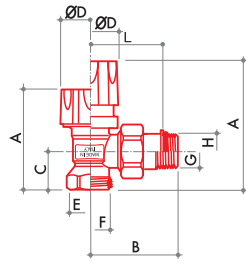

RS 212

Angle radiator valve, thermostatically or electronically controlled, with protection cap.
Connection for copper and plastic pipe.



Fittings



CODE	SIZE	A	B	C	D	E	F	G	H	L			
12121700*	DN 10 3/8	57	52	19	37	-	W24x19	R 3/8	-	-	158	10	80
12122100*	DN 15 1/2	59	54	22	37	-	W24x19	R 1/2	-	-	182	10	80

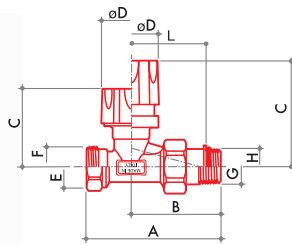

RD 211

Straight radiator valve, thermostatically or electronically controlled, with protection cap.
Connection for copper and plastic pipe.

Fittings



CODE	SIZE	A	B	C	D	E	F	G	H	L			
12321700	DN 10 3/8	76	51	46	37	-	W24x19	R 3/8	-	-	179	10	80
12322100	DN 15 1/2	81	55	46	37	-	W24x19	R 1/2	-	-	203	10	80

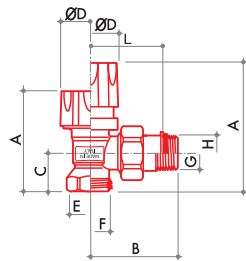

RS 209

Angle radiator valve, thermostatically or electronically controlled, with protection cap.
Connection for copper and plastic pipe.



Fittings



CODE	SIZE	A	B	C	D	E	F	G	H	L			
12122117*	DN 10 3/8	57	47	19	37	-	W24x19	-	G 3/8	37	164	10	80
12122103*	DN 15 1/2	60	49	22	37	-	W24x19	-	G 1/2	39	185	10	80

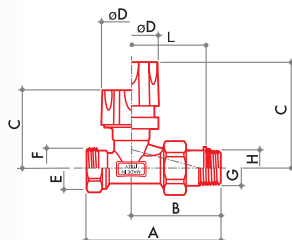

RD 208

Straight radiator valve, thermostatically or electronically controlled, with protection cap.
Connection for copper and plastic pipe.

Fittings



CODE	SIZE	A	B	C	D	E	F	G	H	L			
12322117	DN 10 3/8	73	48	46	37	-	W24x19	-	G 3/8	38	186	10	80
12322103	DN 15 1/2	78	51	46	37	-	W24x19	-	G 1/2	40	203	10	80

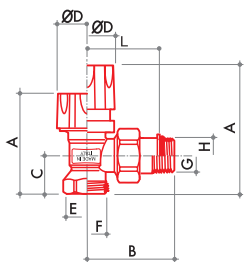

RS 2512

Angle radiator valve, thermostatically or electronically controlled, with manual control knob. Connection for copper and plastic pipe.



Fittings

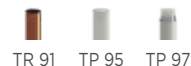

CODE	SIZE	A	B	C	D	E	F	G	H	L			
12721700*	DN 10 3/8	74	52	19	37	-	W24x19	R 3/8	-	-	166	10	80
12722100*	DN 15 1/2	77	54	22	37	-	W24x19	R 1/2	-	-	192	10	80

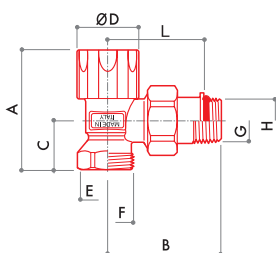

DS 32

Angle regulating lockshield. Connection for copper and plastic pipe.

Fittings



CODE	SIZE	A	B	C	D	E	F	G	H	L			
10161700	DN 10 3/8	52	50	19	30	-	W24x19	R 3/8	-	-	130	10	80
10162100	DN 15 1/2	56	54	22	30	-	W24x19	R 1/2	-	-	159	10	80

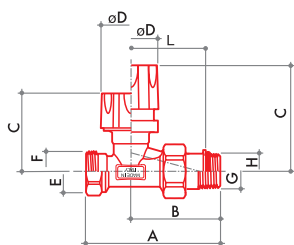

RD 2511

Straight radiator valve, thermostatically or electronically controlled, with manual control knob. Connection for copper and plastic pipe.

Fittings



CODE	SIZE	A	B	C	D	E	F	G	H	L			
12521700	DN 10 3/8	76	51	64	37	-	W24x19	R 3/8	-	-	185	10	80
12522100	DN 15 1/2	81	55	64	37	-	W24x19	R 1/2	-	-	207	10	80

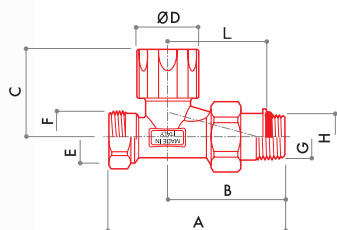

DD 31

Straight regulating lockshield. Connection for copper and plastic pipe.

Fittings

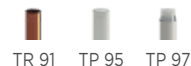

CODE	SIZE	A	B	C	D	E	F	G	H	L			
10361700	DN 10 3/8	76	51	41	30	-	W24x19	R 3/8	-	-	155	10	80
10362100	DN 15 1/2	82	55	42	30	-	W24x19	R 1/2	-	-	178	10	80



Fittings for copper pipe



Fittings for plastic pipe



Fittings for multilayer pipe



Fittings: chapter 7



Accessories: chapter 1.A

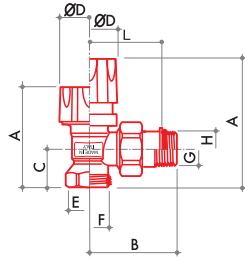

RS 2509

Angle radiator valve, thermostatically or electronically controlled, with manual control knob. Connection for copper and plastic pipe.



Fittings



CODE	SIZE	A	B	C	D	E	F	G	H	L			
12722117*	DN 10 3/8	74	47	19	37	-	W24x19	-	G 3/8	37	172	10	80
12722103*	DN 15 1/2	77	49	22	37	-	W24x19	-	G 1/2	39	193	10	80

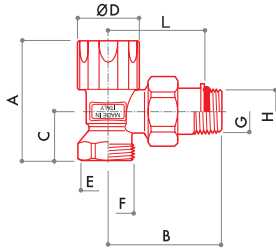

DS 39

Angle regulating lockshield. Connection for copper and plastic pipe.

Fittings



CODE	SIZE	A	B	C	D	E	F	G	H	L			
10162117	DN 10 3/8	52	47	19	30	-	W24x19	-	G 3/8	37	141	10	80
10162103	DN 15 1/2	56	49	22	30	-	W24x19	-	G 1/2	39	163	10	80

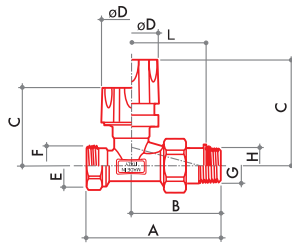

RD 2508

Straight radiator valve, thermostatically or electronically controlled, with manual control knob. Connection for copper and plastic pipe.

Fittings



CODE	SIZE	A	B	C	D	E	F	G	H	L			
12522117	DN 10 3/8	73	48	64	37	-	W24x19	-	G 3/8	38	194	10	80
12522103	DN 15 1/2	77	51	64	37	-	W24x19	-	G 1/2	40	211	10	80

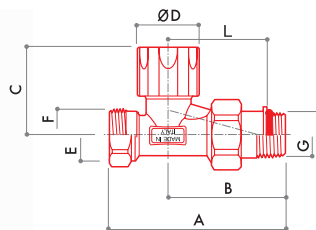

DD 38

Straight regulating lockshield. Connection for copper and plastic pipe.

Fittings



CODE	SIZE	A	B	C	D	E	F	G	H	L			
10362117	DN 10 3/8	73	48	41	30	-	W24x19	-	G 3/8	38	162	10	80
10362103	DN 15 1/2	77	51	42	30	-	W24x19	-	G 1/2	40	178	10	80

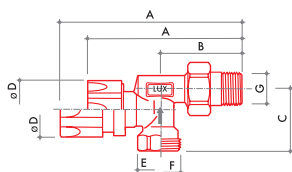

M 330

Reverse angle radiator valve, thermostatically or electronically controlled, with manual control knob. Connection for copper and plastic pipe.

Fittings

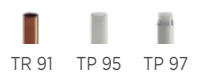

CODE	SIZE	A	B	C	D	E	F	G	H	L			
13122100	DN 15 1/2	116	52	39	35	-	W24x19	R 1/2	-	-	215	10	80

CONNECTION FOR COPPER AND PLASTIC PIPE G3/4 EUROKONUS

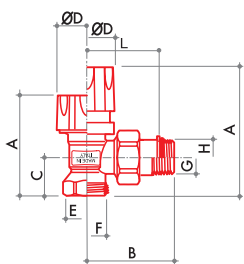

RS 212/A

Angle radiator valve, thermostatically or electronically controlled, with protection cap. Eurokonus connection.



Fittings



CODE	SIZE	A	B	C	D	E	F	G	H	L			
12122718*	DN 10 3/8	56	50	19	37	-	G 3/4 EK	R 3/8	-	-	157	10	80
12122721*	DN 15 1/2	59	54	22	37	-	G 3/4 EK	R 1/2	-	-	181	10	80

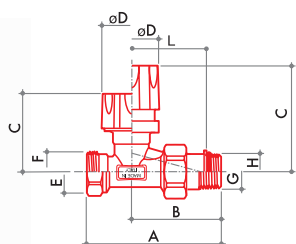

RD 211/A

Straight radiator valve, thermostatically or electronically controlled, with protection cap. Eurokonus connection.

Fittings



CODE	SIZE	A	B	C	D	E	F	G	H	L			
12322719	DN 10 3/8	77	52	46	37	-	G 3/4 EK	R 3/8	-	-	170	10	80
12322722	DN 15 1/2	81	55	46	37	-	G 3/4 EK	R 1/2	-	-	199	10	80

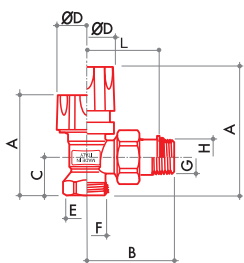

RS 209/A

Angle radiator valve, thermostatically or electronically controlled, with protection cap. Eurokonus connection.



Fittings



CODE	SIZE	A	B	C	D	E	F	G	H	L			
12122717*	DN 10 3/8	57	47	19	37	-	G 3/4 EK	-	G 3/8	37	163	10	80
12122703*	DN 15 1/2	60	49	22	37	-	G 3/4 EK	-	G 1/2	39	184	10	80

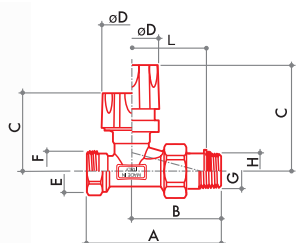

RD 208/A

Straight radiator valve, thermostatically or electronically controlled, with protection cap. Eurokonus connection.

Fittings



CODE	SIZE	A	B	C	D	E	F	G	H	L			
12322717	DN 10 3/8	73	48	46	37	-	G 3/4EK	-	G 3/8	38	182	10	80
12322703	DN 15 1/2	77	51	46	37	-	G 3/4EK	-	G 1/2	40	199	10	80



Fittings for copper pipe



Fittings for plastic pipe



Fittings for multilayer pipe



Fittings: chapter 7



Accessories: chapter 1.A

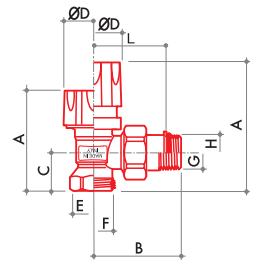

RS 2512/A

Angle radiator valve, thermostatically or electronically controlled, with manual control knob. Eurokonus connection.



Fittings



CODE	SIZE	A	B	C	D	E	F	G	H	L			
12722718*	DN 10 3/8	74	50	19	37	-	G 3/4 EK	R 3/8	-	-	163	10	80
12722721*	DN 15 1/2	77	54	22	37	-	G 3/4 EK	R 1/2	-	-	189	10	80

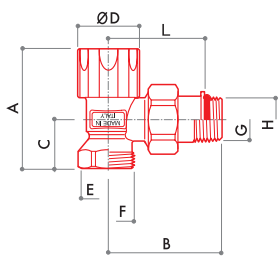

DS 32/A

Angle regulating lockshield. Connections eurokonus type.

Fittings



CODE	SIZE	A	B	C	D	E	F	G	H	L			
10162718	DN 10 3/8	52	50	19	30	-	G 3/4 EK	R 3/8	-	-	139	10	80
10162721	DN 15 1/2	56	54	22	30	-	G 3/4 EK	R 1/2	-	-	162	10	80

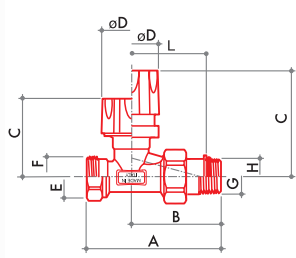

RD 2511/A

Straight radiator valve, thermostatically or electronically controlled, with manual control knob. Eurokonus connection.

Fittings



CODE	SIZE	A	B	C	D	E	F	G	H	L			
12522719	DN 10 3/8	77	52	64	37	-	G 3/4 EK	R 3/8	-	-	196	10	80
12522722	DN 15 1/2	81	55	64	37	-	G 3/4 EK	R 1/2	-	-	207	10	80

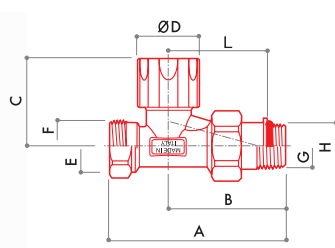

DD 31/A

Straight regulating lockshield. Connections eurokonus type.

Fittings



CODE	SIZE	A	B	C	D	E	F	G	H	L			
10362719	DN 10 3/8	76	51	41	30	-	G 3/4 EK	R 3/8	-	-	164	10	80
10362722	DN 15 1/2	82	55	42	30	-	G 3/4 EK	R 1/2	-	-	174	10	80

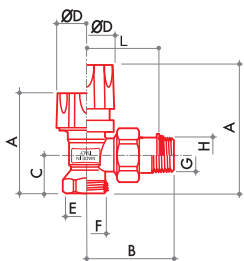

RS 2509/A

Angle radiator valve, thermostatically or electronically controlled, with manual control knob. Eurokonus connection.



Fittings



CODE	SIZE	A	B	C	D	E	F	G	H	L			
12722717*	DN 10 3/8	74	47	19	37	-	G 3/4EK	-	G 3/8	37	171	10	80
12722703*	DN 15 1/2	77	49	22	37	-	G 3/4EK	-	G 1/2	39	192	10	80

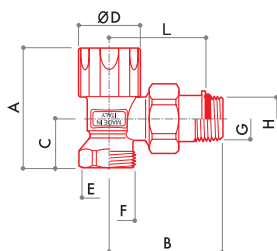

DS 39/A

Angle regulating lockshield. Connections eurokonus type.

Fittings



CODE	SIZE	A	B	C	D	E	F	G	H	L			
10162717	DN 10 3/8	52	47	19	30	-	G 3/4 EK	-	G 3/8	37	144	10	80
10162703	DN 15 1/2	56	49	22	30	-	G 3/4 EK	-	G 1/2	39	166	10	80

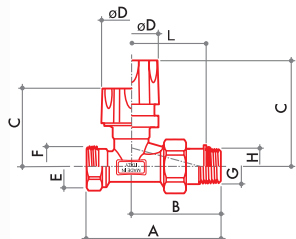

RD 2508/A

Straight radiator valve, thermostatically or electronically controlled, with manual control knob. Eurokonus connection.

Fittings



CODE	SIZE	A	B	C	D	E	F	G	H	L			
12522717	DN 10 3/8	73	48	64	37	-	G 3/4EK	-	G 3/8	38	190	10	80
12522703	DN 15 1/2	77	51	64	37	-	G 3/4EK	-	G 1/2	40	207	10	80

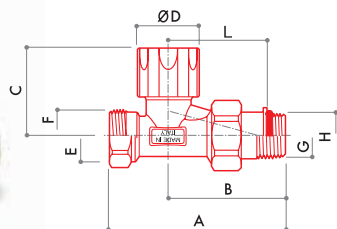

DD 38/A

Straight regulating lockshield. Connections eurokonus type.

Fittings



CODE	SIZE	A	B	C	D	E	F	G	H	L			
10362717	DN 10 3/8	73	48	41	30	-	G 3/4 EK	-	G 3/8	38	165	10	80
10362703	DN 15 1/2	77	51	42	30	-	G 3/4 EK	-	G 1/2	40	178	10	80

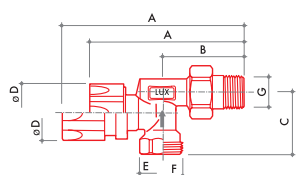

M 330/A

Reverse angle radiator valve, thermostatically or electronically controlled, with manual control knob. Eurokonus connection.

Fittings



CODE	SIZE	A	B	C	D	E	F	G	H	L			
13122721	DN 15 1/2	116	52	39	35	-	G 3/4 EK	R 1/2	-	-	217	10	80



Fittings for copper pipe



Fittings for plastic pipe



Fittings for multilayer pipe



Fittings: chapter 7



Accessories: chapter 1.A

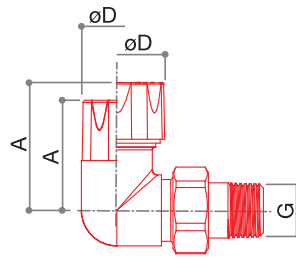

MD 321/A

Coaxial right radiator valve, thermostatically or electronically controlled, with protection cap. Eurokonus connection.

Fittings



CODE	SIZE	A	B	C	D	E	F	G	H	L			
13272722	DN 15 1/2	49	56	27	37	-	G 3/4 EK	R 1/2	-	-	287	10	80

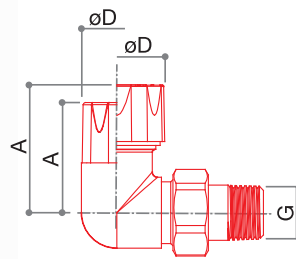

MS 331/A

Coaxial left regulating lockshield. Eurokonus connections.

Fittings



CODE	SIZE	A	B	C	D	E	F	G	H	L			
13252722	DN 15 1/2	42	56	27	30	-	G 3/4 EK	R 1/2	-	-	258	10	80

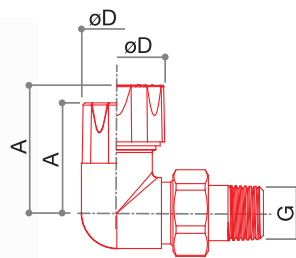

MS 321/A

Left coaxial radiator valve, thermostatically or electronically controlled, with protection cap. Eurokonus connection.

Fittings



CODE	SIZE	A	B	C	D	E	F	G	H	L			
13292722	DN 15 1/2	49	56	27	37	-	G 3/4 EK	R 1/2	-	-	287	10	80

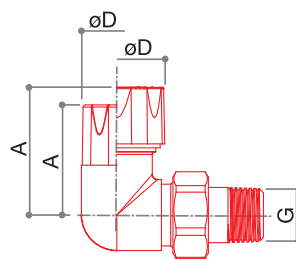

MD 331/A

Coaxial right regulating lockshield. Eurokonus connections.

Fittings



CODE	SIZE	A	B	C	D	E	F	G	H	L			
13232722	DN 15 1/2	42	56	27	30	-	G 3/4 EK	R 1/2	-	-	258	10	80

TT 3000

THERMOSTATIC HEAD



* UNI EN 215
Approved



TECHNICAL DATA

VALVE CONNECTION



Max temperature
120 °C



Max pressure
10 bar



Max differential pressure
0,6 bar

Min. adjustment temperature (anti-freeze pos.)

Ts min 6 °C

Max regulation temperature (max position)

Ts max 30 °C (5)

Energy saving conditions

20 °C

Thermostatic element inalterability range

-15 °C ÷ 60 °C

Storage temperature

-20 °C ÷ + 50 °C

Hysteresis

C 0,4 k

Differential pressure influence

D 0,5 k

Water temperature influence

W 0,25 k

Response time

Z 22 min.

Control Accuracy

CA 0,2 K.



M 30 x 1,5

Available with
chrome finish
(chapter 50th Series)



CHROME

WHITE-CHROME

BLACK

CONSTRUCTIVE FEATURES

Thermostatic heads consist of a sensor filled with a highly expandable element. This element, which may be incorporated in the adjustment knob or in the remote sensor, expands or contracts in proportion to room temperature changes, reacting even to the smallest variation. When the surrounding

temperature increases, the element expands and acts on the obturator with an axial thrust movement, thus controlling the valve action. The flow of the heating medium can be adjusted by opening and closing the valve.

TECHNICAL FEATURES IN COMBINATION WITH THERMOSTATIC HEAD TT 3000

POS	ITEM	Kv Δt 1 °C	Kv ΔT 1 °C	qmN (Kg/h)	qm max (Kg/h)	a
1	RS 202 DN 15 - RS 206 DN 15	0.07	0.07	23±65%	32	0.42
2	RS212 DN10 - RS212 DN15 RS209 DN10 - RS209 DN15	0.20	0.25	80±40%	100	0.36
3	RS212/A DN15 - RS209/A DN15	0.24	0.36	113±30%	155	0.46
4	RS2502 DN15 - RS2506 DN15 RS2512 DN10 - RS2512 DN15	0.24	0.37	116±20%	180	0.57
5	RS2509 DN10 - RS2509 DN15	0.24	0.40	128±20%	250	0.74
6	RS2512/A DN15 - RS2509/A DN15	0.32	0.52	165±10%	440	0.84

RANGE OF ADJUSTMENT

Thermostatic valves allow to make each room independent with a specific set temperature, thus enhancing comfort and actual energy saving, as prescribed by national and international regulations. Thermostatic heads can also maintain an anti-freeze temperature (position “❄️”), which is very useful in order to prevent frost damage when rooms are not being used. During summer it is instead recommended to set the heads to the maximum opening (position “5”).

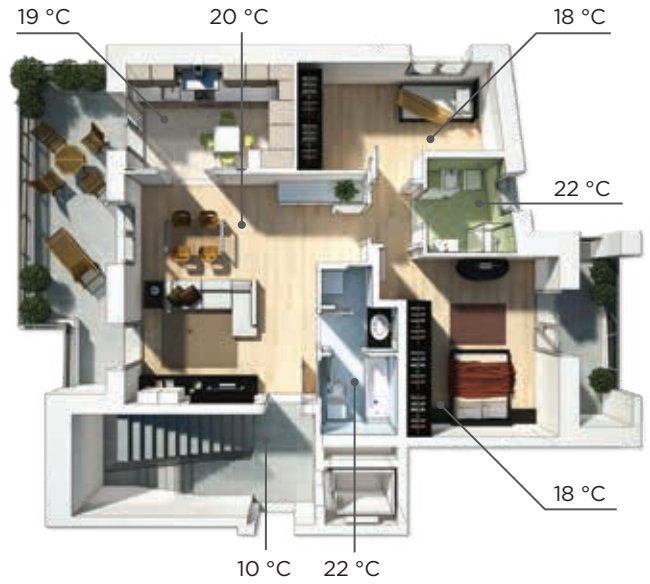
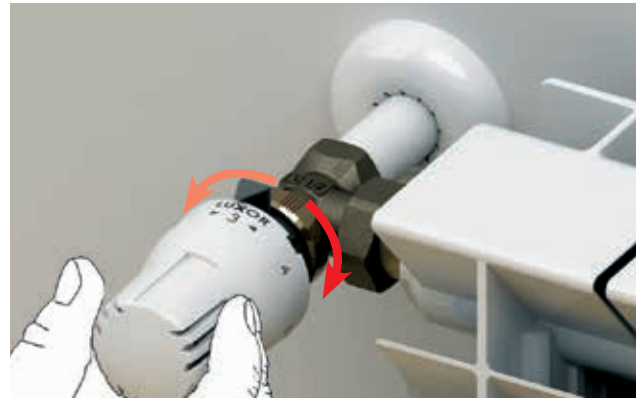
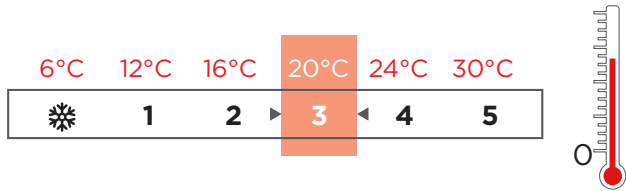

INSTRUCTIONS FOR USE

Before installing the thermostatic head, set the adjustment knob to “5”, so as to facilitate the following installation steps. Unscrew the RAL 9016 white ABS protection cap mounted on ThermoTekna thermostic valves. Tighten the brass collar of the thermostatic head to the valve body, then set the knob to the desired position.



LIMITING AND LOCKING TEMPERATURE



The head's temperature range can be limited or locked by using the provided fork pin. To lock the temperature to “3”, turn the knob so that the indicator corresponds to the required position. The temperature can be locked by inserting the fork pin across the

spline placed diametrically opposite to the index (fig. 1). Insert the fork pin to the left of the spline to limit the temperature to values between “3” and “5” (fig. 2), to the right to set a temperature range between “3” and “❄️” (fig. 3).

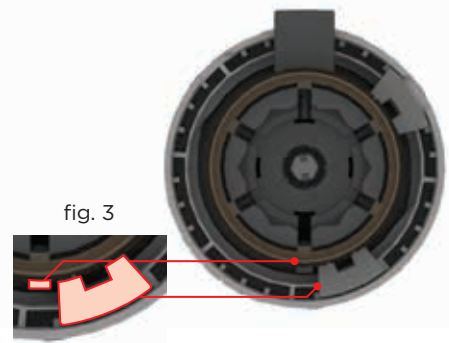
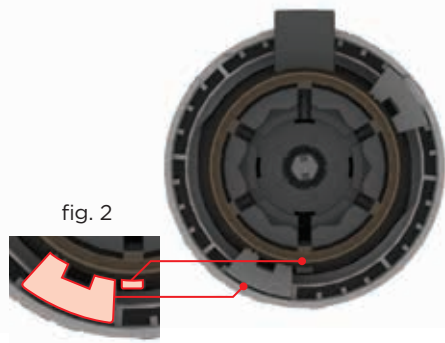
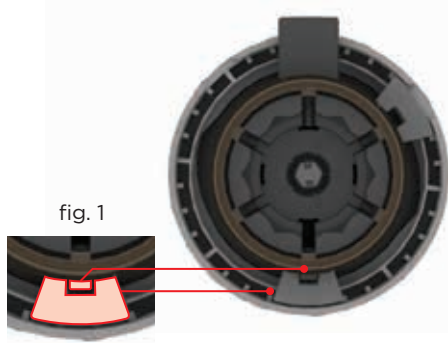

INSTALLATION WARNINGS



TT3000 thermostatic heads can be applied to all heating bodies unless in presence of barriers such as shelves, curtains or furniture, which may accumulate heat and therefore alter the measurement of room temperature. In this case, it is recommended to use **TT3002** thermostatic heads with remote sensor.

In systems where all heating bodies are controlled by thermostatic heads, it is advisable to install a bypass valve in order to avoid noise due to the excessive pressure difference which might arise inside thermostatic valves.

Thermostatic heads must be installed away from the heat streams surrounding the heating body (fig. 1) and direct sunlight (fig. 2).

Do not install thermostatic heads under shelves (fig. 3), in a recess (fig. 4), within the heat stream (fig. 5) or behind curtains (fig. 6).

These kinds of installation are not proper, as they may cause the head to measure temperature values which do not coincide with the actual room temperature.



Should the heating body be installed as in fig. 1, a number of issues may arise. The door could not be opened completely and, unless provided with a doorstop, it could hit and damage the head.

In cases like this, it is advisable to use a reverse radiator valve as shown in fig. 2.

THERMOSTATIC HEADS

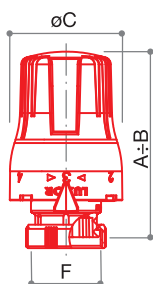

TT 3000

Thermostatic head with integrated control and sensor.



CODE	SIZE	A	B	C	D	E	F	G	H	L			
69100000	M30x1,5	75	80	46,5	-	-	M30x1,5	-	-	-	110	1	100

CODE	SIZE	A	B	C	D	E	F	G	H	L			
69100000BRA*	M30x1,5	75	80	46,5	-	-	M30x1,5	-	-	-	110	1	100

*With Braille numbers

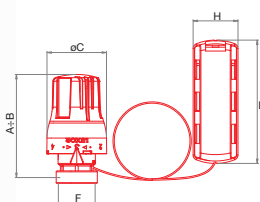

TT 3002

Thermostatic head with integrated control and remote sensor. Standard length of capillary 2 m.

CODE	SIZE	A	B	C	D	E	F	G	H	L			
69100020	M30x1,5	75	80	46,5	-	-	M30x1,5	-	35	96	156	1	32



BT 242

Tamper-and-theft-proof clip for TT 3000 and TT 3002.

CODE	SIZE			
69010402	-	14	5	160

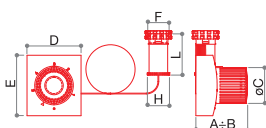

TT 2302

In-wall thermostatic head with control and remote sensor. Standard length of capillary 2 m.

CODE	SIZE	A	B	C	D	E	F	G	H	L			
69011005	M30x1,5	63	68	45	67	75	M30x1,5	-	28	51	220	1	30



The certification of the valves according to UNI EN 215 applies to the coupling valve+thermostatic head Luxor TT 3000. **Technical information are available on our website: www.luxor.it**

VALVES FLOW RATE CHART

ANGLE VALVES

DN 10 - DN 15

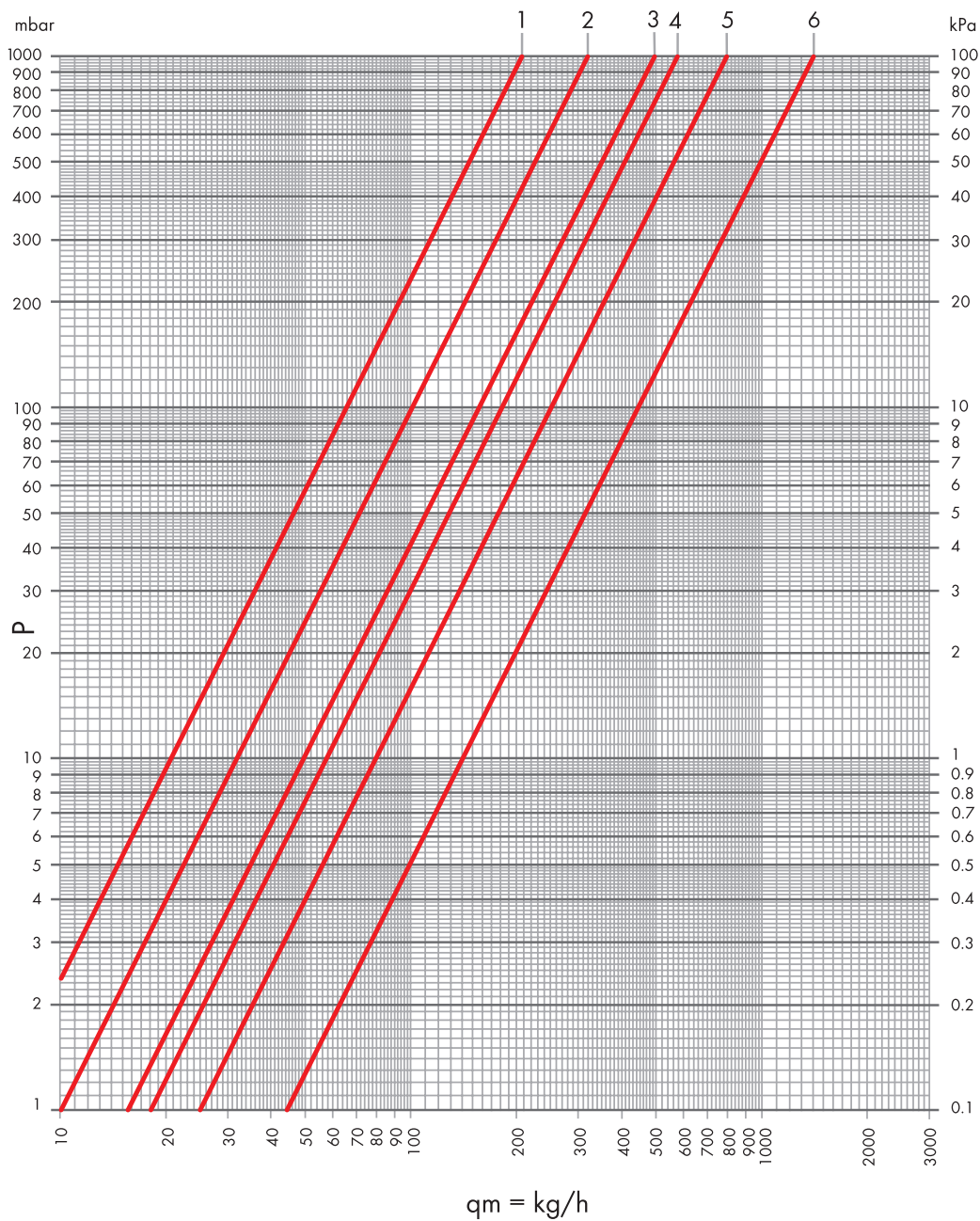

ITEM	Kv	Kv Δt 1 °C	Kv Δt 2 °C	POS
Angle DN 10 - DN 15	0.10	0.07	0.07	1
	0.32	0.20	0.25	2
	0.49	0.24	0.36	3
	0.57	0.24	0.37	4
	0.79	0.24	0.40	5
	1.39	0.32	0.55	6

VALVES FLOW RATE CHART

ANGLE VALVES

DN 20

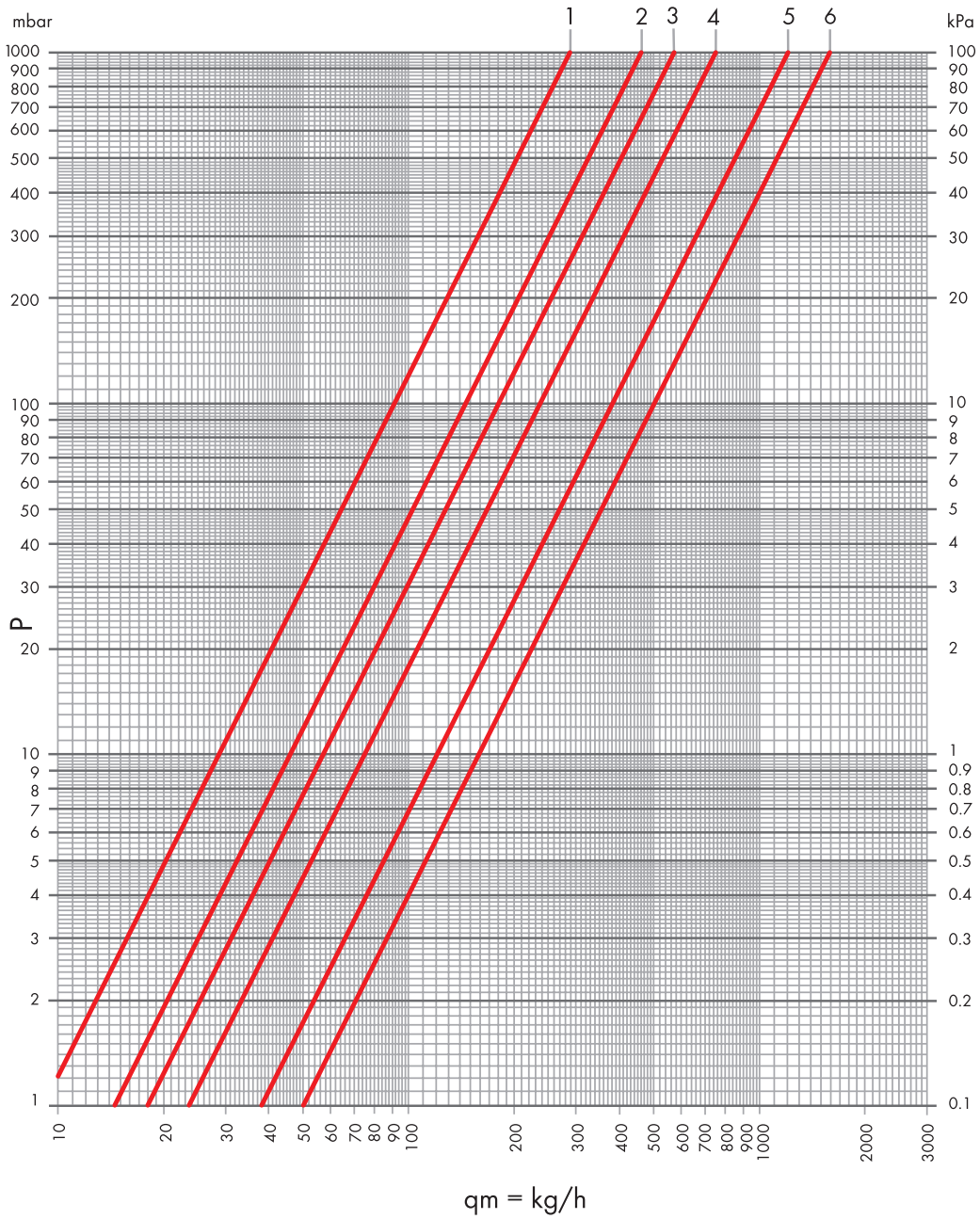

ITEM	Kv	Kv Δt 1 °C	Kv Δt 2 °C	POS
Angle DN 20	0.29	0.15	0.19	1
	0.49	0.20	0.25	2
	0.57	0.24	0.36	3
	0.75	0.26	0.41	4
	1.20	0.31	0.55	5
	1.58	0.32	0.56	6

VALVES FLOW RATE CHART

STRAIGHT VALVES

DN 10 - DN 15

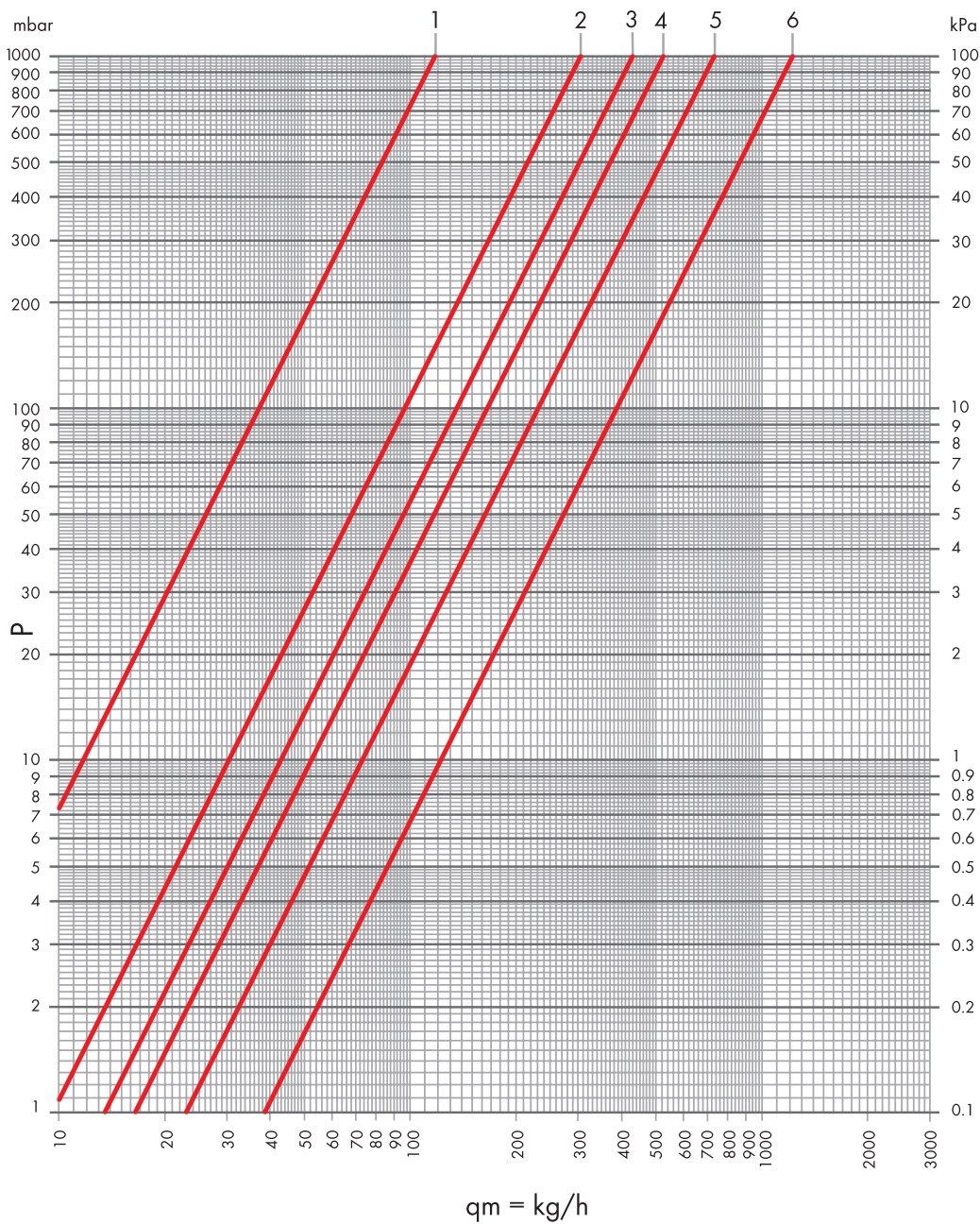

ITEM	Kv	Kv Δt 1 °C	Kv Δt 2 °C	POS
Straight DN 10 - DN 15	0.12	0.10	0.11	1
	0.30	0.20	0.25	2
	0.43	0.24	0.36	3
	0.52	0.24	0.37	4
	0.72	0.24	0.40	5
	1.21	0.29	0.49	6

VALVES FLOW RATE CHART

STRAIGHT VALVES

DN 20

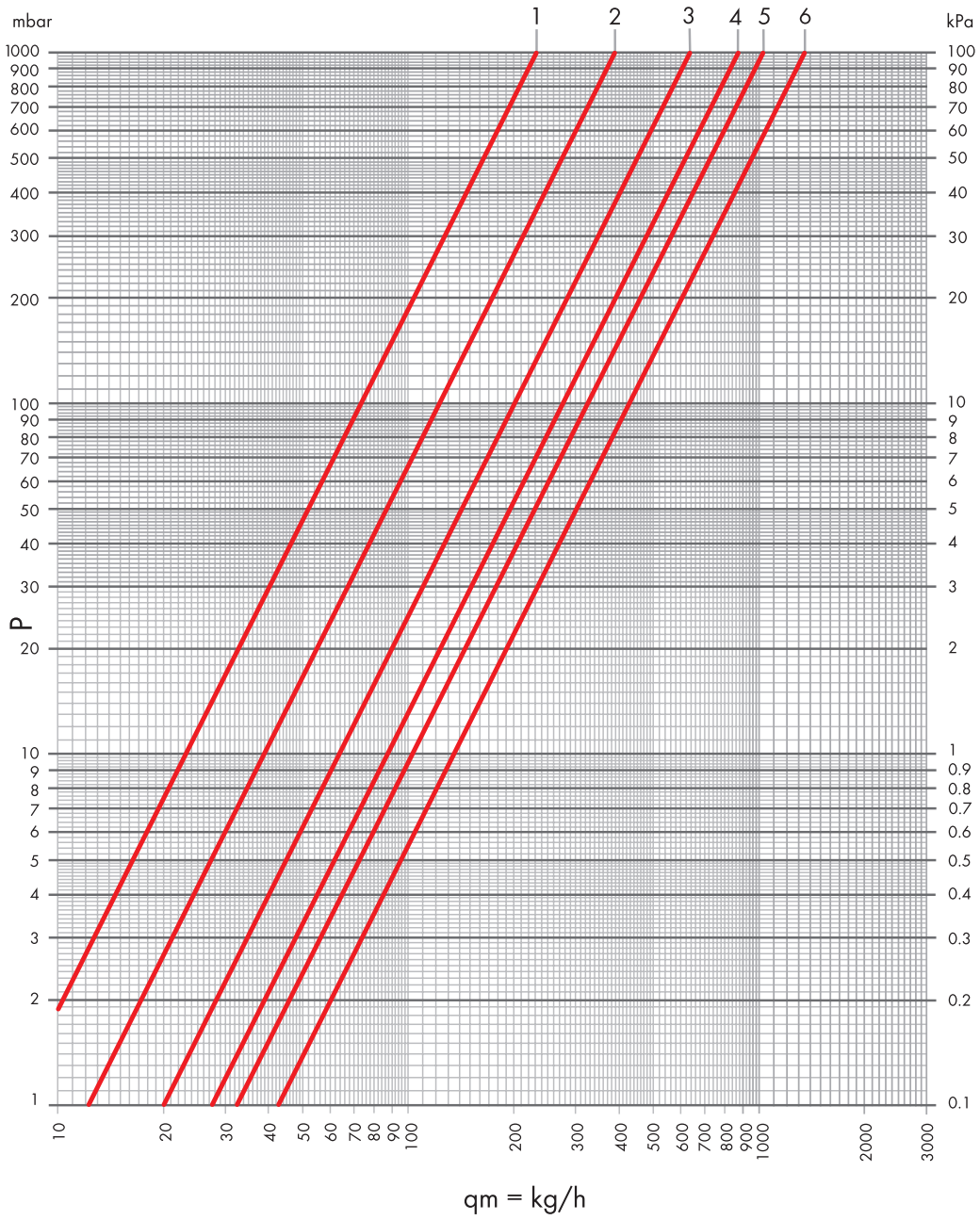

ITEM	Kv	Kv Δt 1 °C	Kv Δt 2 °C	POS
Straight DN 20	0.23	0.16	0.19	1
	0.39	0.22	0.25	2
	0.63	0.25	0.36	3
	0.87	0.29	0.41	4
	1.02	0.30	0.50	5
	1.34	0.31	0.52	6

LOCKSHIELD FLOW RATE CHART

ANGLE LOCKSHIELD

DN 10 3/8

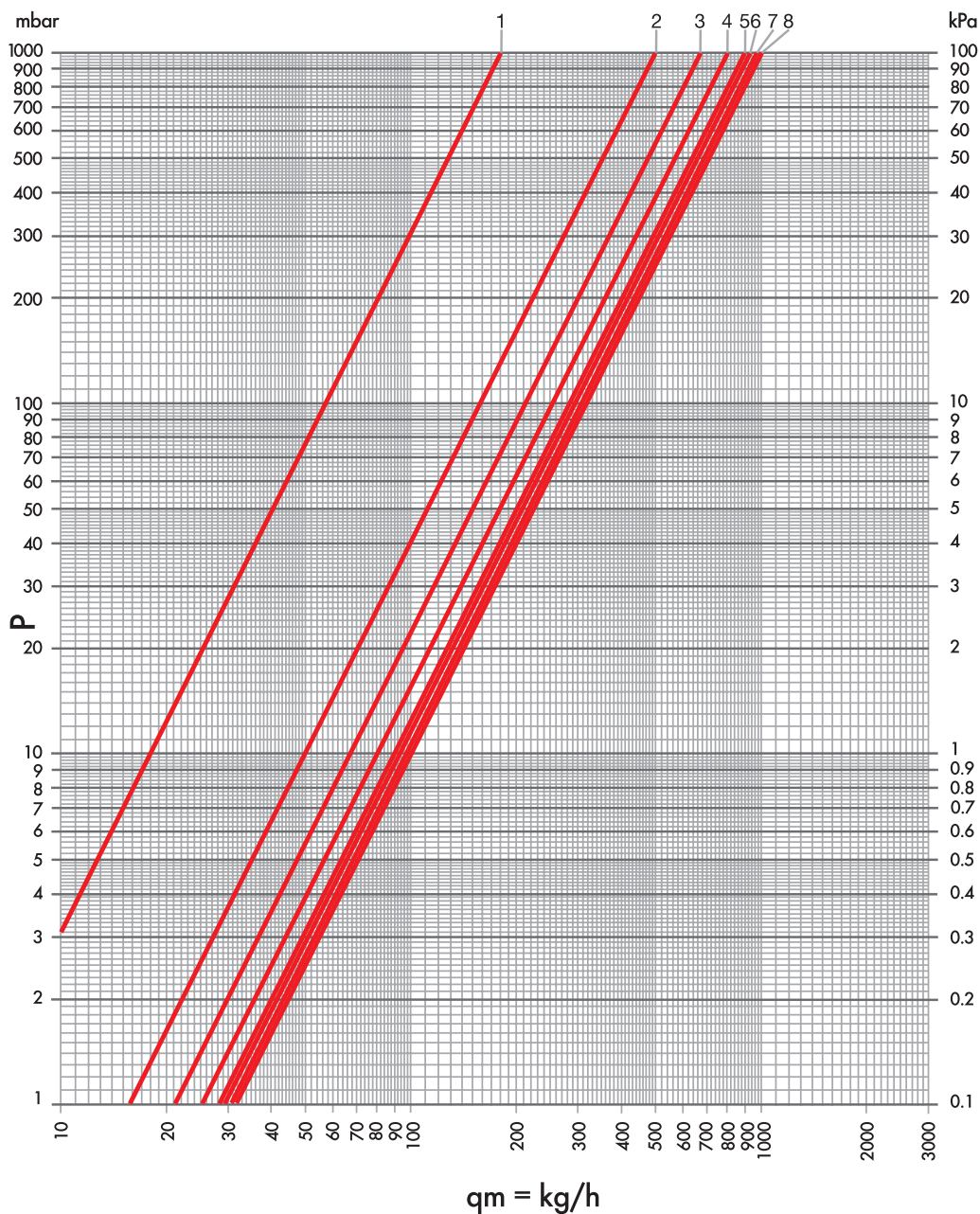

ITEM	TURNS N°	Kvs	POS
DS 22 DS 26 DS 32 DS 39 DS 32/A DS 39/A	1	0.18	1
	1+1/2	0.50	2
	2	0.67	3
	2+1/2	0.80	4
	3	0.90	5
	3+1/2	0.93	6
	4	0.97	7
	all open	1.00	8

LOCKSHIELD FLOW RATE CHART

ANGLE LOCKSHIELD

DN 15 1/2

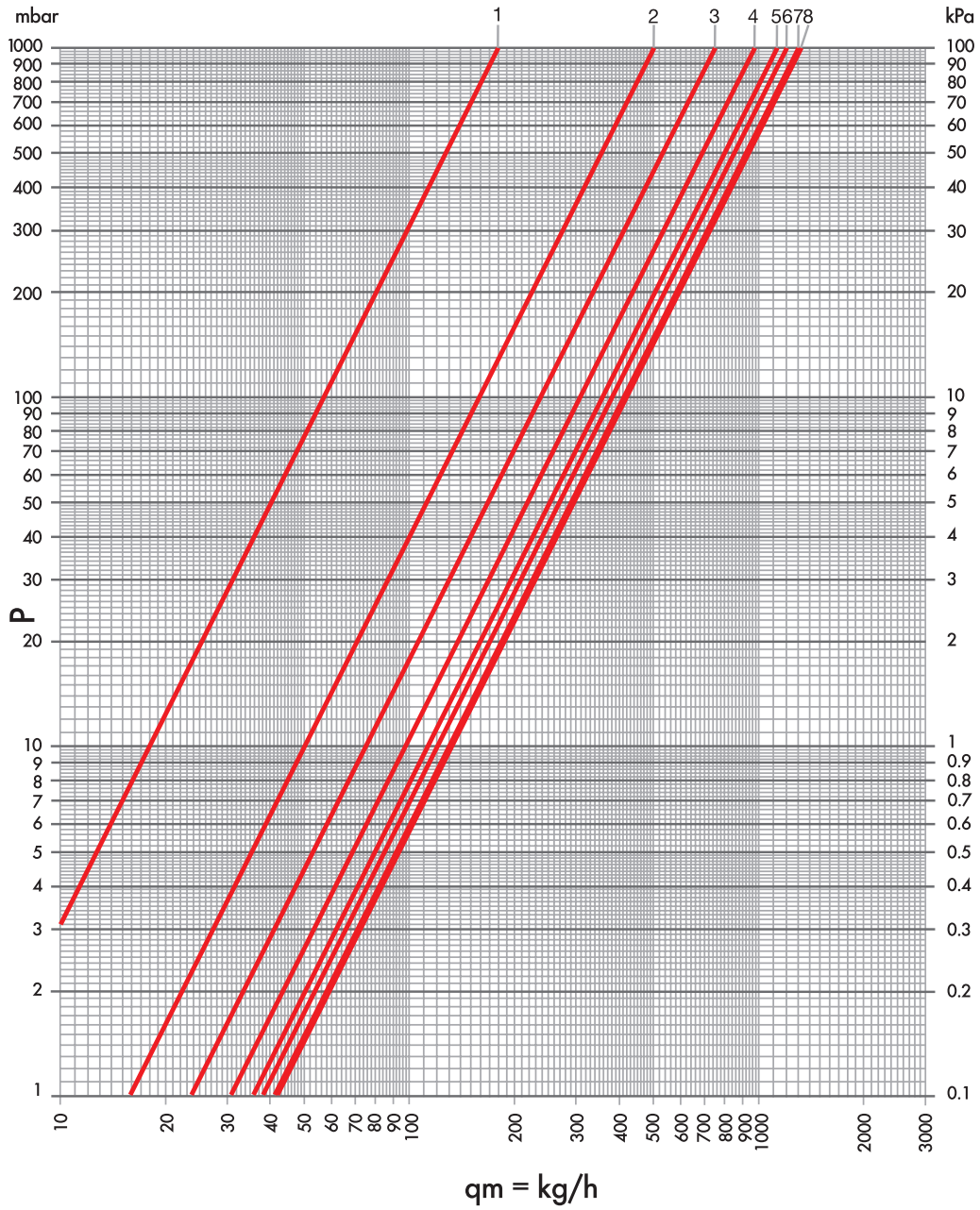

ITEM	TURNS N°	Kvs	POS
DS 22 DS 26 DS 32 DS 39 DS 32/A DS 39/A	1	0.18	1
	1+1/2	0.50	2
	2	0.75	3
	2+1/2	0.97	4
	3	1.12	5
	3+1/2	1.20	6
	4	1.30	7
	all open	1.31	8

LOCKSHIELD FLOW RATE CHART

ANGLE LOCKSHIELD

DN 20 3/4

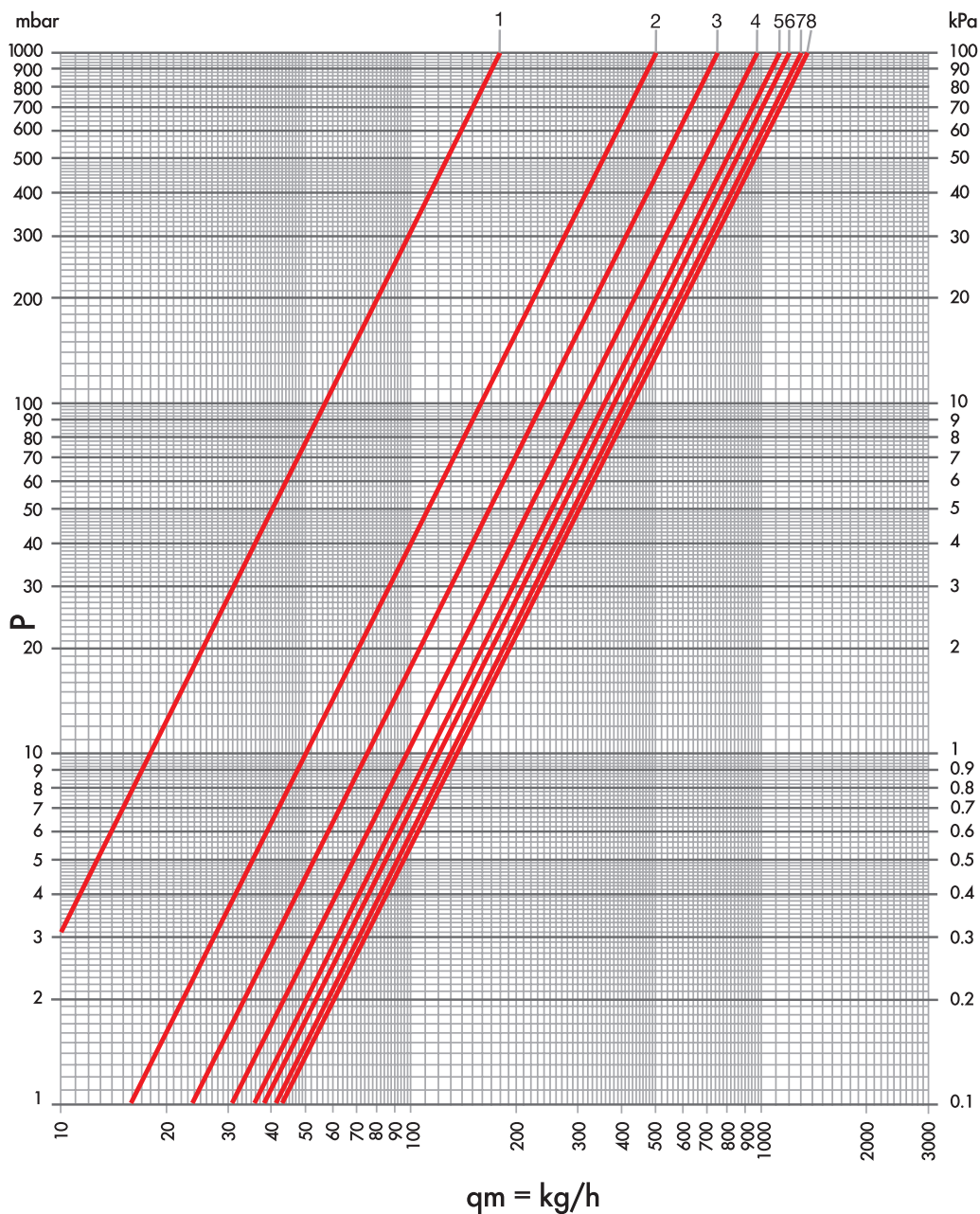

ITEM	TURNS N°	Kvs	POS
DS 22 DS 26 DS 32 DS 39 DS 32/A DS 39/A	1	0.18	1
	1+1/2	0.50	2
	2	0.75	3
	2+1/2	0.97	4
	3	1.12	5
	3+1/2	1.20	6
	4	1.30	7
	all open	1.34	8

LOCKSHIELD FLOW RATE CHART

STRAIGHT LOCKSHIELD

DN 10 3/8

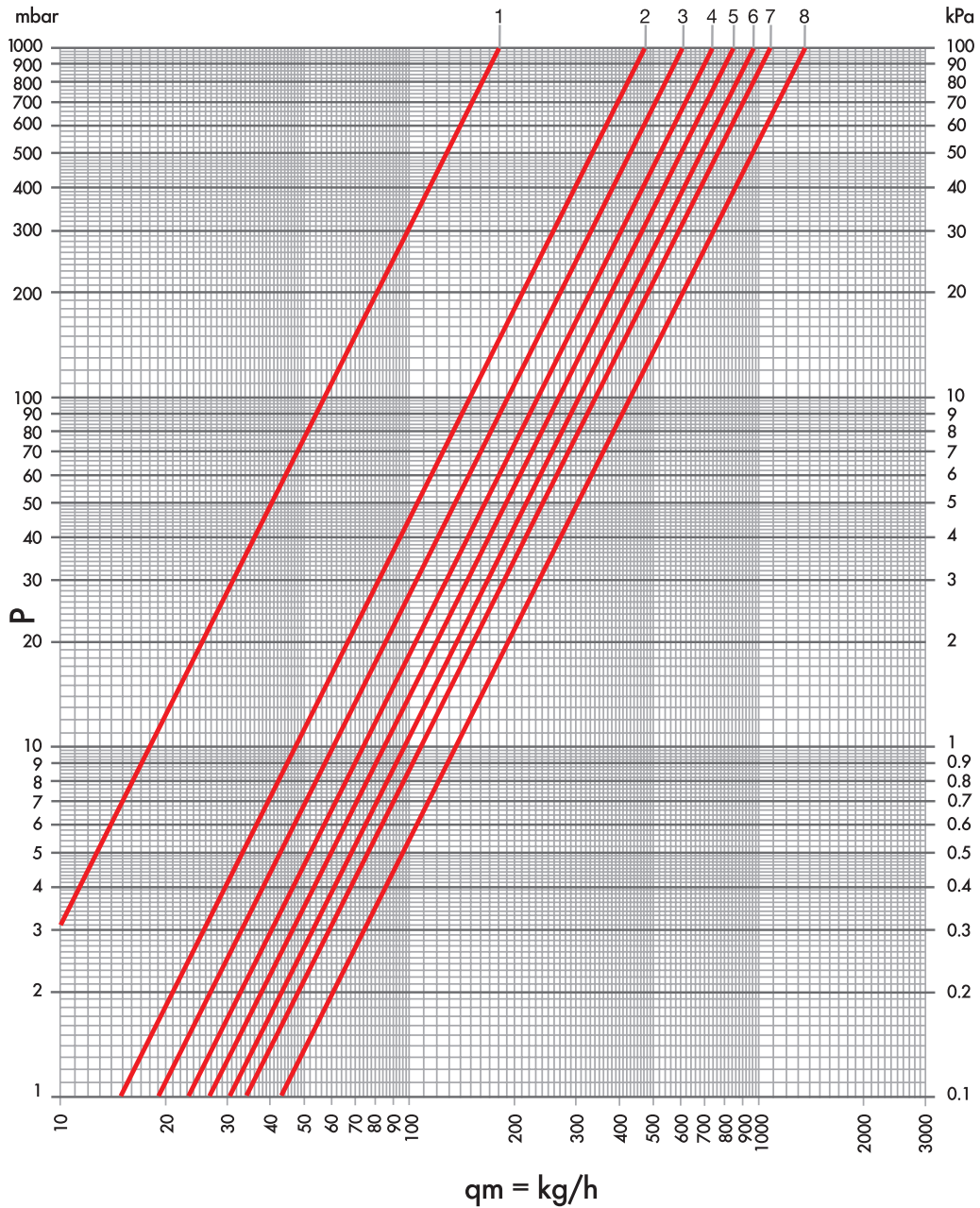

ITEM	TURNS N°	Kvs	POS
DD 21 DD 25 DD 31 DD 38 DD 31/A DD 38/A	1	0.18	1
	1+1/2	0.47	2
	2	0.60	3
	2+1/2	0.73	4
	3	0.84	5
	3+1/2	0.95	6
	4	1.07	7
	all open	1.34	8

LOCKSHIELD FLOW RATE CHART

STRAIGHT LOCKSHIELD

DN 15 1/2

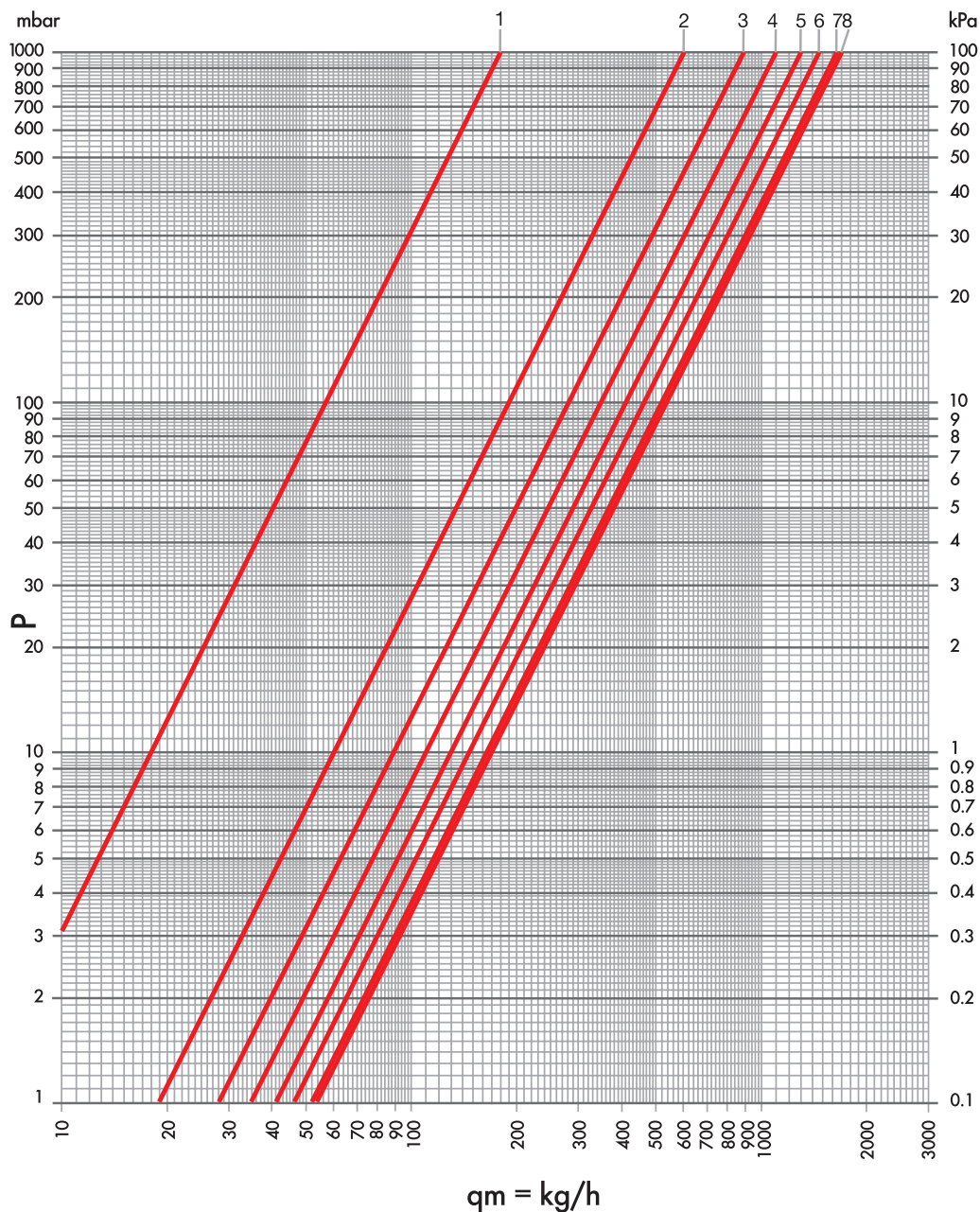

ITEM	TURNS N°	Kvs	POS
DD 21 DD 25 DD 31 DD 38 DD 31/A DD 38/A	1	0.18	1
	1+1/2	0.60	2
	2	0.89	3
	2+1/2	1.10	4
	3	1.30	5
	3+1/2	1.46	6
	4	1.63	7
	all open	1.70	8

LOCKSHIELD FLOW RATE CHART

STRAIGHT LOCKSHIELD

DN 20 3/4

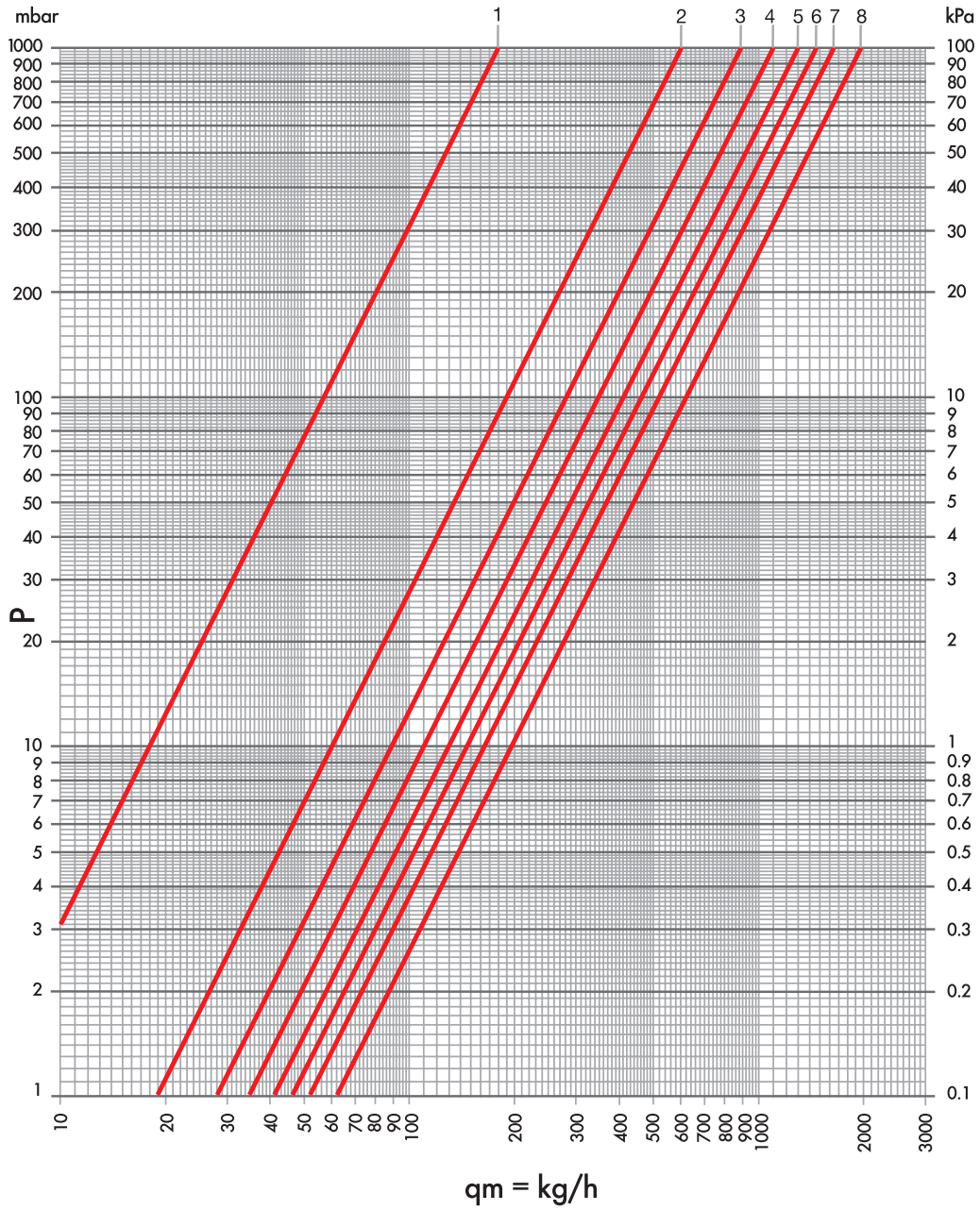

ITEM	TURNS N°	Kvs	POS
DD 21 DD 25 DD 31 DD 38 DD 31/A DD 38/A	1	0.18	1
	1+1/2	0.60	2
	2	0.89	3
	2+1/2	1.10	4
	3	1.30	5
	3+1/2	1.46	6
	4	1.63	7
	all open	1.96	8



LUXOR®

RADIATOR VALVES

1.3 / 30 SERIES

30 SERIES RADIATOR VALVES



The screw of 30 Series valves allows to preset the flow thanks to a shaped acetal ring. The thermostatic screw enables to replace one of the o-rings on the control stem without draining the system. The valves are chrome plated.



The tightness of 30 Series lockshields is ensured by an o-ring on the obturator and, if necessary, by a further o-ring between the body and the plug. When in closed position, the tightness is granted by an o-ring and a conical metal collar. The lockshields are chrome plated. All lockshields allow for flow adjustment by limiting the lift of the obturator.



The 30 Series manual valve features a fixed stem, whose tightness is ensured by two o-rings. When in closed position, the tightness is granted by an o-ring and a conical metal collar. The valves are chrome plated.

TECHNICAL DATA



DN

15



Max temperature

120 °C



Max pressure

10 bar



Max differential pressure (thermostatic valves)

0,6 bar



Max differential pressure

1 bar



Materials

CW617N
UNI EN
12165:2016



Knob

Plated ABS
white ABS
RAL 9016



Stem

AISI 316



Testing

100%

SYSTEM CONNECTIONS



Iron pipe
(manual valves)
G 1/2

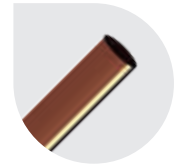

Copper pipe
G 3/4 EK - TR 91/AC



Plastic pipe
G 3/4 EK - TP 98/C



Multilayer pipe
G 3/4 EK - TP 99/C

RADIATOR CONNECTION



Cylindrical thread with soft sealing
G 1/2

FLOW ADJUSTMENT AND REVERSE FLOW

To adjust the maximum flow rate, proceed as follows:

- align the reference mark on the stainless steel stem with one of the positions marked on the valve.

Luxor thermostatic valves are now EN 215 approved in reverse flow mode as well.

This characteristic allows for installation on the inlet as well as on the outlet of the radiator up to a 0,6 bar differential pressure.

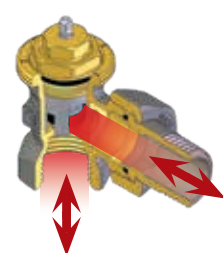
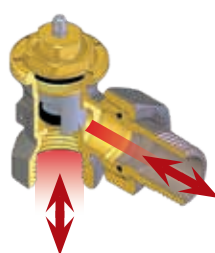
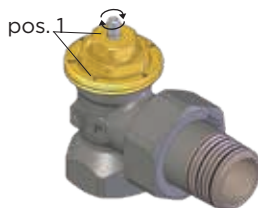

All valves and lockshields are 100% checked with an electronically controlled pneumatic test.

The characteristics of the fluid in the system must be compliant with the UNI 8065: 2019 directive.

CONNECTION FOR IRON PIPE



CHROME

WHITE-CHROME

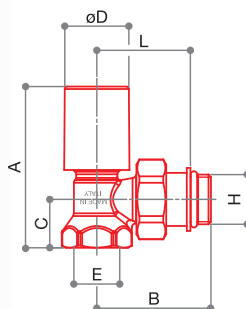

KT 146

Complete angle manual kit for radiator connection. Consisting of two RS 146. Connection for iron pipe.

Fittings



CODE	SIZE	FINISH	A	B	C	D	E	F	G	H	L			
20822103	DN 15 1/2	CHROME	67	47	20	27	G 1/2	-	-	G 1/2	39	343	1	32
20822103CB	DN 15 1/2	WHITE-CHROME	67	47	20	27	G 1/2	-	-	G 1/2	39	343	1	32

CONNECTION FOR PLASTIC PIPE G 3/4 EUROKONUS.



CHROME

WHITE-CHROME

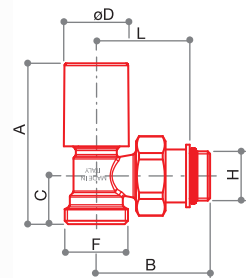

KT 159/A

Complete angle manual kit for radiator connection. Consisting of two RS 159/A. Connection G 3/4 eurokonus.

Fittings



CODE	SIZE	FINISH	A	B	C	D	E	F	G	H	L			
20842703	DN 15 1/2	CHROME	67	47	20	27	-	G 3/4 EK	-	G 1/2	39	340	1	32
20842703CB	DN 15 1/2	WHITE-CHROME	67	47	20	27	-	G 3/4 EK	-	G 1/2	39	340	1	32



CHROME

WHITE-CHROME

KT 2509/A

Complete angle thermostatic kit for radiator connection. Consisting of RS 2009/A + DS 89/A. Connection G 3/4 eurokonus.

Fittings



CODE	SIZE	FINISH			
20742703	DN 15 1/2	CHROME	380	1	32
20742703CB	DN 15 1/2	WHITE-CHROME	380	1	32

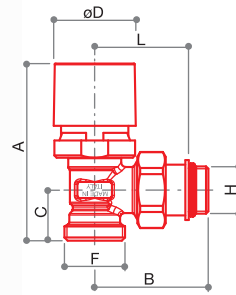

RS 2509/A

Angle radiator valve thermostatically or electrically controllable with manual adjustment knob. Connection G 3/4 eurokonus.

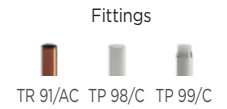

CODE	SIZE	FINISH	A	B	C	D	E	F	G	H	L			
20722703	DN 15 1/2	CHROME	77	49	22	36	-	G 3/4 EK	-	G 1/2	41	203	10	80
20722703CB	DN 15 1/2	WHITE-CHROME	77	49	22	36	-	G 3/4 EK	-	G 1/2	41	203	10	80

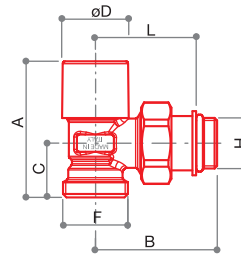

DS 89/A

Angle regulating lockshield. Connection G 3/4 eurokonus.

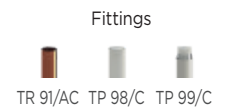

CODE	SIZE	FINISH	A	B	C	D	E	F	G	H	L			
20162703	DN 15 1/2	CHROME	55	49	22	27	-	G 3/4 EK	-	G 1/2	41	168	10	80
20162703CB	DN 15 1/2	WHITE-CHROME	55	49	22	27	-	G 3/4 EK	-	G 1/2	41	168	10	80

VALVES FLOW RATE CHART

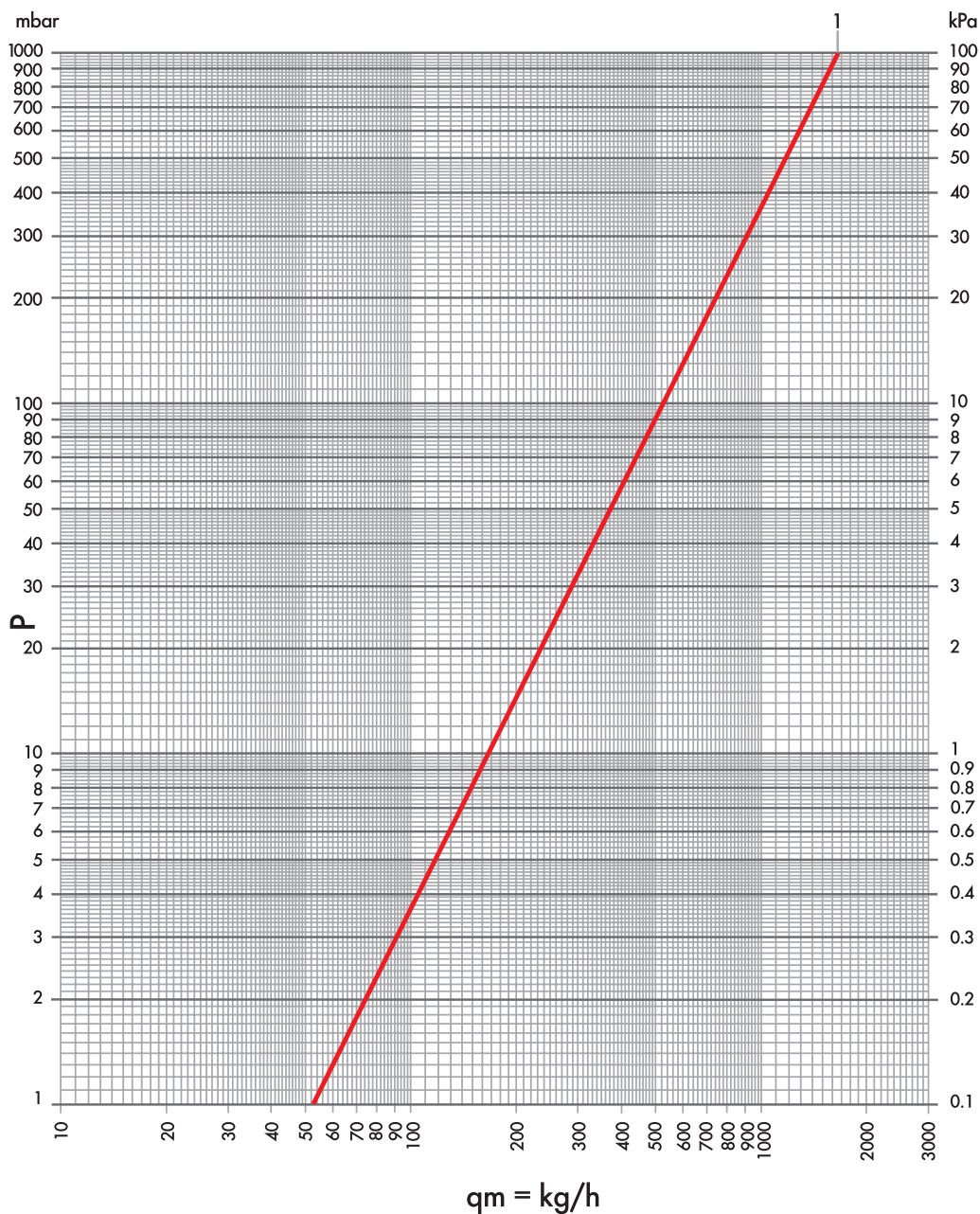

ITEM	Kv	POS
RS 159/A 1/2	1,65	1

VALVES FLOW RATE CHART

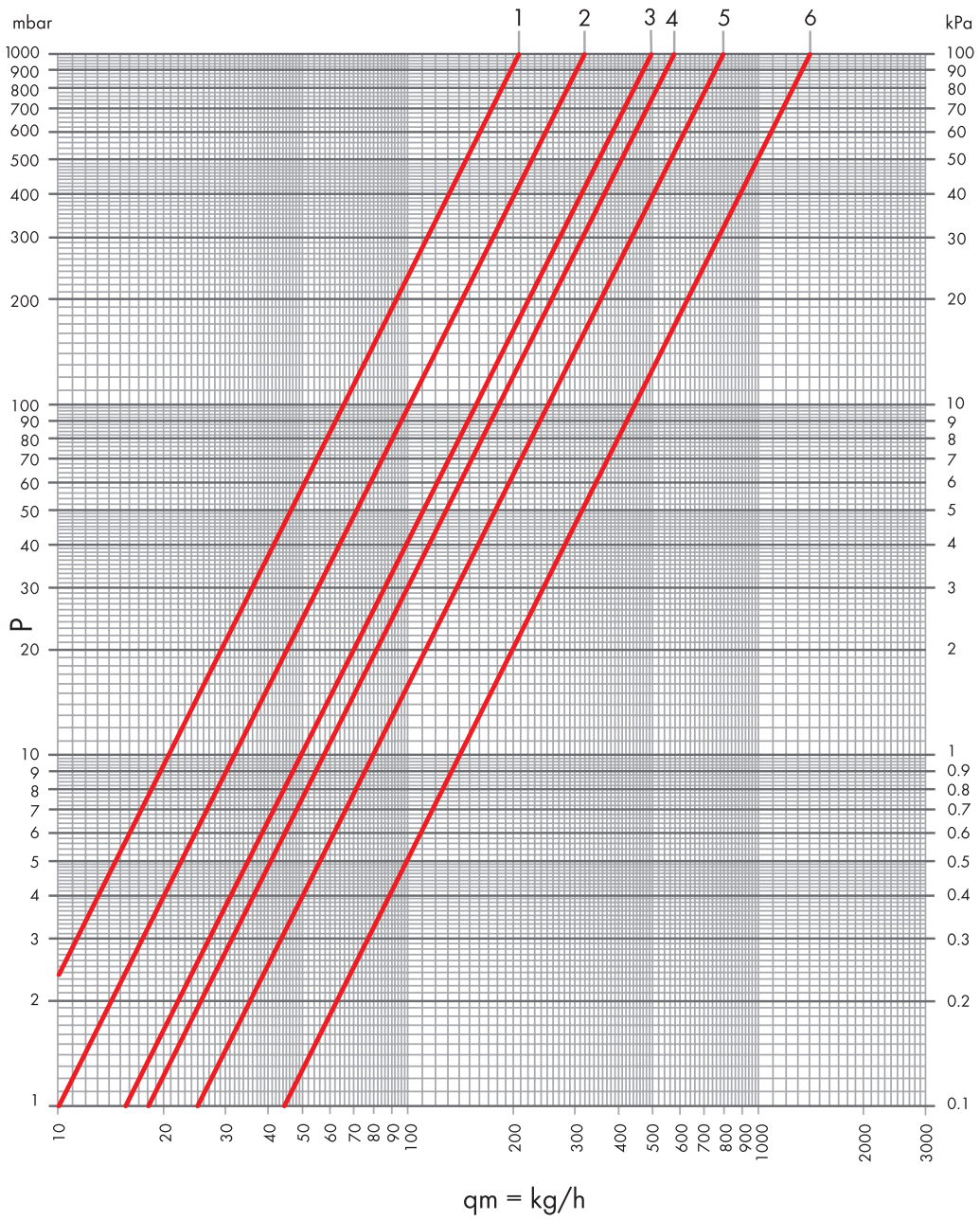

ITEM	Kv	Kv Δt 1 °C	Kv Δt 2 °C	POS
RS 2509/A	0,10	0,07	0,07	1
	0,32	0,2	0,25	2
	0,49	0,24	0,36	3
	0,57	0,24	0,37	4
	0,79	0,24	0,40	5
	1,39	0,32	0,55	6

LOCKSHIELD FLOW RATE CHART

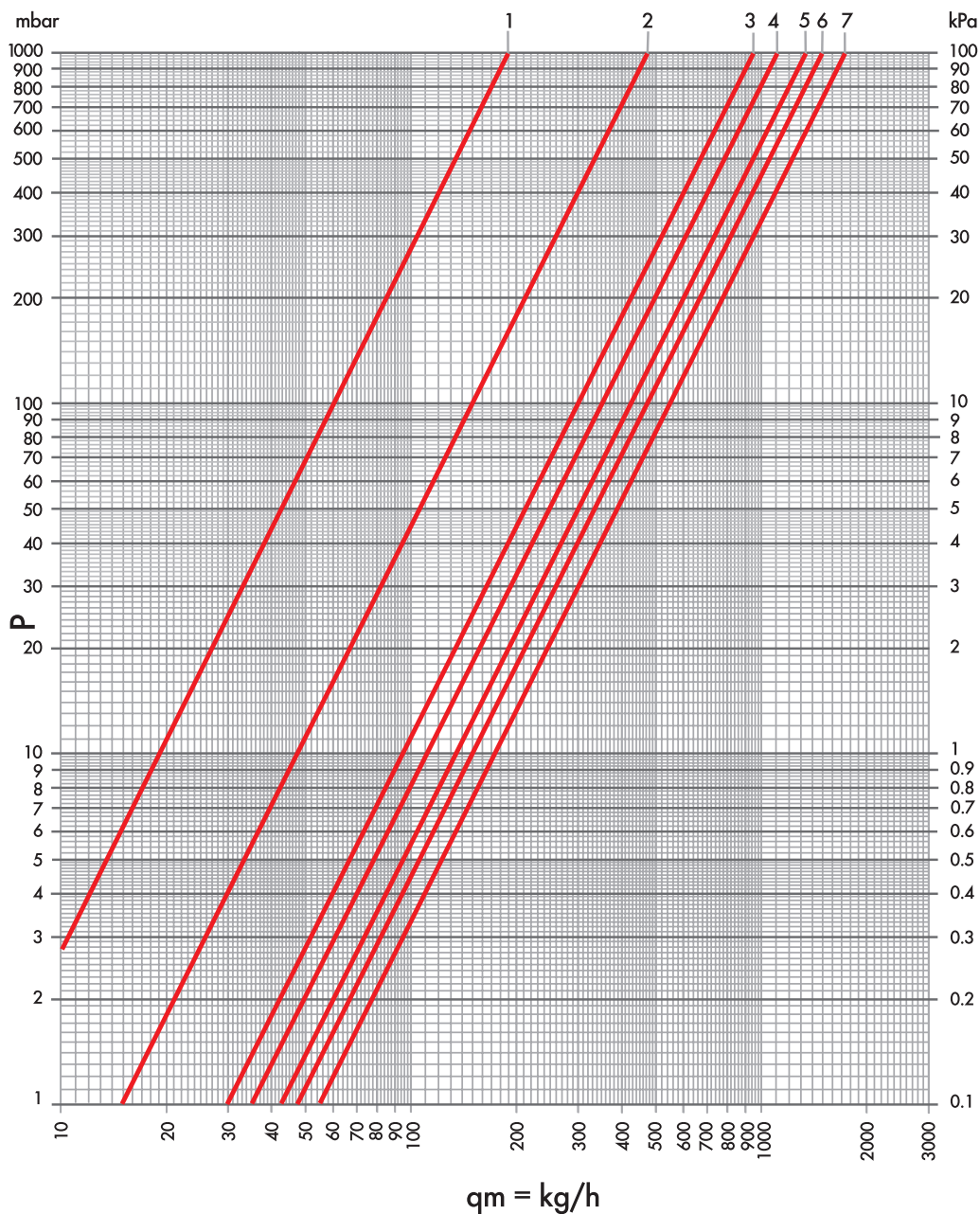

ITEM	LOOP N°	Kv	POS
DS 89/A	1	0,19	1
	1+1/2	0,48	2
	2	0,71	3
	2+1/2	0,92	4
	3	1,06	5
	3+1/2	1,18	6
	all open	1,29	7



LUXOR®

RADIATOR VALVES

1.4 / 50th SERIES

50th SERIES RADIATOR VALVES



The screw of 50th Series valves allows to preset the flow thanks to a shaped acetal ring. The thermostatic screw enables to replace one of the o-rings on the control stem without draining the system.



The tightness of 50th Series lockshields is ensured by an o-ring on the obturator and, if necessary, by a further o-ring between the body and the plug. When in closed position, the tightness is granted by an o-ring and a conical metal collar. The lockshields are available in chrome plated or white/chrome plated version. All lockshields allow for flow adjustment by limiting the lift of the obturator.



The 50th Series manual valve features a fixed stem, whose tightness is ensured by two o-rings. When in closed position, the tightness is granted by a flat gasket. The valves are available in chrome plated and white/chrome plated version. Valves and lockshields must be opened with a differential pressure lower than 1 bar.

TECHNICAL DATA



DN
15



Max temperature
120 °C



Max pressure
10 bar



Max differential pressure (thermostatic valves)
0,6 bar



Max differential pressure
1 bar



Materials
CW617N
UNI EN
12165:2016



Knob
Plated ABS
white ABS
RAL 9016



Stem
AISI 316

SYSTEM CONNECTIONS

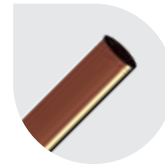

Copper pipe
G 3/4 EK - TR 91/AC

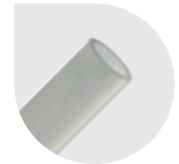

Plastic pipe
G 3/4 EK - TP 98/C



Multilayer pipe
G 3/4 EK - TP 99/C

RADIATOR CONNECTION



Cylindrical thread with soft sealing
G 1/2

FINISH



chrome



white



white-chrome



black

HOW TO SELECT THE CORRECT COAXIAL VALVES

COAXIAL RIGHT THERMOSTATIC KIT



Left lockshield

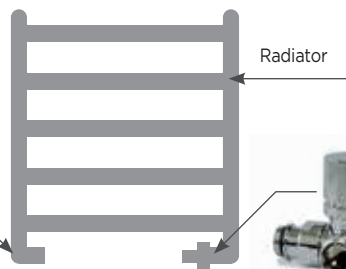

Radiator



Thermostatic valve or right manual

COAXIAL LEFT THERMOSTATIC KIT



Thermostatic valve or left manual

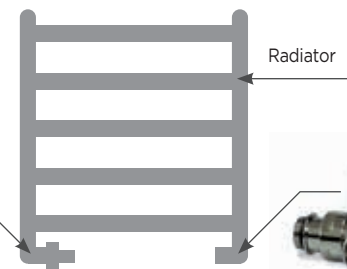

Radiator



Right lockshield

The characteristics of the fluid in the system must be compliant with the UNI 8065: 2019 directive.

FLOW ADJUSTMENT

To adjust the maximum flow rate, proceed as follows:

- align the reference mark on the stainless steel stem with one of the positions marked on the valve.

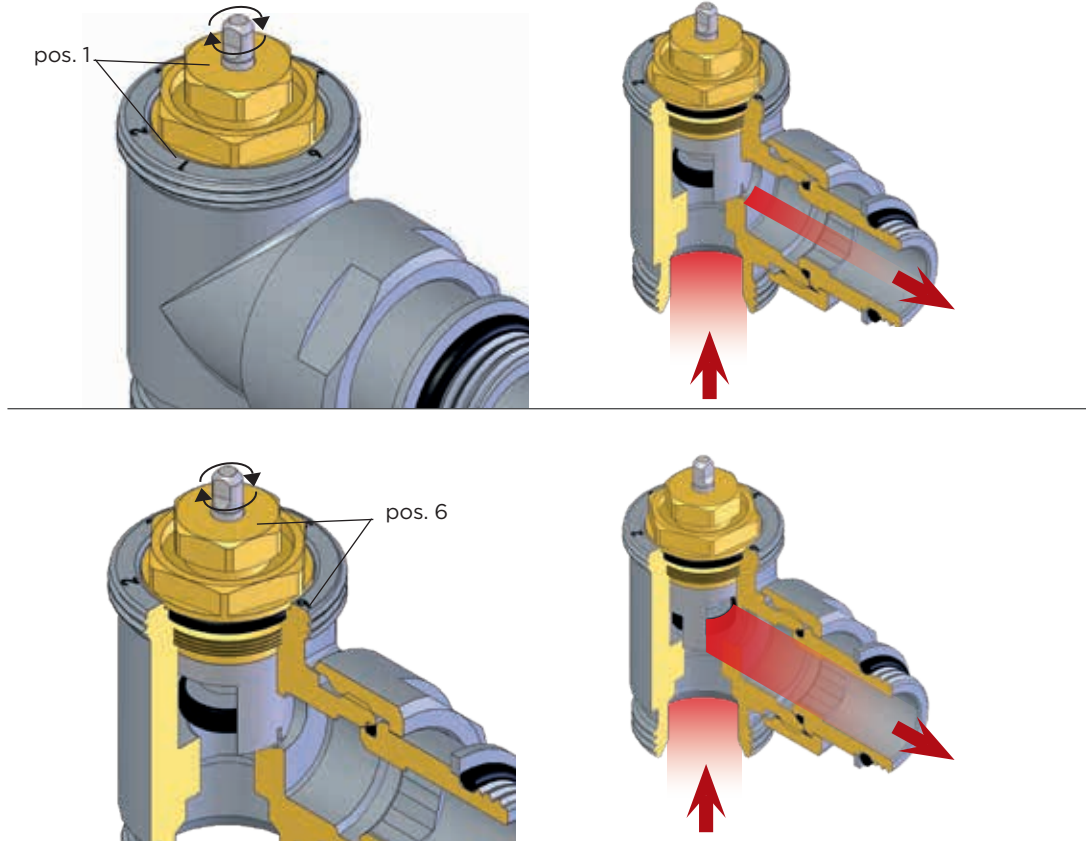

TIGHTNESS ON THE STEM

The tightening system can be easily replaced without draining the system:

- unscrew the hexagonal collar with a 13 mm wrench key;

- remove the o-ring "art. 582 - code 3424602", clean the stainless steel stem, insert a new o-ring "art. 582";
- assemble the collar screwing tight.



REPLACEMENT OF THE SCREW

Thanks to article CH 111- code 67822719 the screw can be replaced while the system is operating and without draining it.

THERMOSTATIC KIT: CONNECTION FOR COPPER AND PLASTIC PIPE G3/4 EUROKONUS









CHROME

 WHITE-CHROME
 ARTICLE DISCONTINUED

WHITE

KT 259/A

Complete angle thermostatic kit for radiator connection. Consisting of RS 259/A + DS 79/A + TT 3000C. Eurokonus connection.

CODE	SIZE	FINISH						
14702703	DN 15 1/2	CHROME	TR 91/AC	TP 98/C	TP 99/C	603	1	12
14702703CB	DN 15 1/2	WHITE-CHROME	TR 91/AC	TP 98/C	TP 99/C	604	1	12
14702703B	DN 15 1/2	WHITE	TR 91/AC	TP 98/C	TP 99/C	604	1	12









CHROME

 WHITE-CHROME
 ARTICLE DISCONTINUED

WHITE

KT 258/A

Complete straight thermostatic kit for radiator connection. Consisting of RD 258/A + DD 78/A + TT 3000C. Eurokonus connection.

CODE	SIZE	FINISH						
14902703	DN 15 1/2	CHROME	TR 91/AC	TP 98/C	TP 99/C	663	1	12
14902703CB	DN 15 1/2	WHITE-CHROME	TR 91/AC	TP 98/C	TP 99/C	664	1	12
14902703B	DN 15 1/2	WHITE	TR 91/AC	TP 98/C	TP 99/C	664	1	12









CHROME

 WHITE-CHROME
 ARTICLE DISCONTINUED

WHITE

KT 269/A

Complete coaxial right thermostatic kit for radiator connection. Consisting of RCD 269/A + DCS 33/A + TT 3000C. Eurokonus connection.

CODE	SIZE	FINISH						
14772703	DN 15 1/2	CHROME	TR 91/AC	TP 98/C	TP 99/C	655	1	12
14772703CB	DN 15 1/2	WHITE-CHROME	TR 91/AC	TP 98/C	TP 99/C	658	1	12
14772703B	DN 15 1/2	WHITE	TR 91/AC	TP 98/C	TP 99/C	658	1	12



CHROME



WHITE-CHROME
ARTICLE DISCONTINUED



WHITE

KT 273/A

Complete coaxial left thermostatic kit for radiator connection. Consisting of RCS 273/A + DCD 29/A + TT 3000C. Eurokonus connection.

CODE	SIZE	FINISH						
14792703	DN 15 1/2	CHROME	TR 91/AC	TP 98/C	TP 99/C	655	1	12
14792703CB	DN 15 1/2	WHITE-CHROME	TR 91/AC	TP 98/C	TP 99/C	658	1	12
14792703B	DN 15 1/2	WHITE	TR 91/AC	TP 98/C	TP 99/C	658	1	12



CHROME



WHITE-CHROME
ARTICLE DISCONTINUED



WHITE



BLACK

KT 2059/A

Complete angle thermostatic kit for radiator connection. Consisting of RS 2059/A + DS 79/A. Eurokonus connection.

CODE	SIZE	FINISH						
14742703	DN 15 1/2	CHROME	TR 91/AC	TP 98/C	TP 99/C	503	1	12
14742703CB	DN 15 1/2	WHITE-CHROME	TR 91/AC	TP 98/C	TP 99/C	507	1	12
14742703B	DN 15 1/2	WHITE	TR 91/AC	TP 98/C	TP 99/C	507	1	12
14742703N	DN 15 1/2	BLACK	TR 91/AC	TP 98/C	TP 99/C	507	1	12

Kit with fittings included.

CODE	SIZE	FINISH			
14010001	DN 15 1/2	CHROME	503	1	12
14010001CB	DN 15 1/2	WHITE-CHROME	507	1	12

	Fitting	Code	Size
2x	TR 91/AC	67761200C	12 mm
2x	TR 91/AC	67761400C	14 mm
2x	TP 99/C	67861612C	16x2

CODE	SIZE	FINISH			
14010001B	DN 15 1/2	WHITE	507	1	12

2x	TR 91/AC	67761200B	12 mm
2x	TR 91/AC	67761400B	14 mm
2x	TP 99/C	67861612B	16x2

CODE	SIZE	FINISH			
14010001N	DN 15 1/2	BLACK	507	1	12

2x	TR 91/AC	67761200N	12 mm
2x	TR 91/AC	67761400N	14 mm
2x	TP 99/C	67861612N	16x2



Fittings for copper pipe



Fittings for plastic pipe



Fittings for multilayer pipe



Fittings: chapter 7



Accessories: chapter 1.A



CHROME



WHITE-CHROME
ARTICLE DISCONTINUED



WHITE

KT 2058/A

Complete straight thermostatic kit for radiator connection. Consisting of RD 2058/A + DD 78/A. Eurokonus connection.

CODE	SIZE	FINISH						
14942703	DN 15 1/2	CHROME	TR 91/AC	TP 98/C	TP 99/C	565	1	12
14942703CB	DN 15 1/2	WHITE-CHROME	TR 91/AC	TP 98/C	TP 99/C	567	1	12
14942703B	DN 15 1/2	WHITE	TR 91/AC	TP 98/C	TP 99/C	567	1	12



CHROME



WHITE-CHROME
ARTICLE DISCONTINUED



WHITE



BLACK

KT 2069/A

Complete coaxial right thermostatic kit for radiator connection. Consisting of RCD 2069/A + DCS 33/A. Eurokonus connection.

CODE	SIZE	FINISH						
14812703	DN 15 1/2	CHROME	TR 91/AC	TP 98/C	TP 99/C	557	1	12
14812703CB	DN 15 1/2	WHITE-CHROME	TR 91/AC	TP 98/C	TP 99/C	561	1	12
14812703B	DN 15 1/2	WHITE	TR 91/AC	TP 98/C	TP 99/C	561	1	12
14812703N	DN 15 1/2	BLACK	TR 91/AC	TP 98/C	TP 99/C	561	1	12

Kit with fittings included.

CODE	SIZE	FINISH			
14010002	DN 15 1/2	CHROME	503	1	12
14010002CB	DN 15 1/2	WHITE-CHROME	507	1	12

CODE	SIZE	FINISH			
14010002B	DN 15 1/2	WHITE	507	1	12

CODE	SIZE	FINISH			
14010002N	DN 15 1/2	BLACK	507	1	12

	Fitting	Code	Size
2x	TR 91/AC	67761200C	12 mm
2x	TR 91/AC	67761400C	14 mm
2x	TP 99/C	67861612C	16x2

2x	TR 91/AC	67761200B	12 mm
2x	TR 91/AC	67761400B	14 mm
2x	TP 99/C	67861612B	16x2

2x	TR 91/AC	67761200N	12 mm
2x	TR 91/AC	67761400N	14 mm
2x	TP 99/C	67861612N	16x2

CHROME

WHITE-CHROME
 ARTICLE DISCONTINUED

WHITE

BLACK
KT 2073/A

Complete coaxial left thermostatic kit for radiator connection. Consisting of RCS 2073/A + DCD 29/A. Eurokonus connection.

CODE	SIZE	FINISH						
14832703	DN 15 1/2	CHROME	TR 91/AC	TP 98/C	TP 99/C	557	1	12
14832703CB	DN 15 1/2	WHITE-CHROME	TR 91/AC	TP 98/C	TP 99/C	561	1	12
14832703B	DN 15 1/2	WHITE	TR 91/AC	TP 98/C	TP 99/C	561	1	12
14832703N	DN 15 1/2	BLACK	TR 91/AC	TP 98/C	TP 99/C	561	1	12

Kit with fittings included.

CODE	SIZE	FINISH			
14010003	DN 15 1/2	CHROME	503	1	12
14010003CB	DN 15 1/2	WHITE-CHROME	507	1	12

CODE	SIZE	FINISH			
14010003B	DN 15 1/2	WHITE	507	1	12

CODE	SIZE	FINISH			
14010003N	DN 15 1/2	BLACK	507	1	12

	Fitting	Code	Size
2x	TR 91/AC	67761200C	12 mm
2x	TR 91/AC	67761400C	14 mm
2x	TP 99/C	67861612C	16x2
2x	TR 91/AC	67761200B	12 mm
2x	TR 91/AC	67761400B	14 mm
2x	TP 99/C	67861612B	16x2
2x	TR 91/AC	67761200N	12 mm
2x	TR 91/AC	67761400N	14 mm
2x	TP 99/C	67861612N	16x2

MANUAL KIT: CONNECTION FOR COPPER AND PLASTIC PIPE G3/4 EUROKONUS

CHROME

WHITE-CHROME
 ARTICLE DISCONTINUED

WHITE

BLACK
KT 59/A

Complete angle manual kit for radiator connection. Consisting of RS 59/A + DS 79/A. Eurokonus connection.

CODE	SIZE	FINISH						
14622703	DN 15 1/2	CHROME	TR 91/AC	TP 98/C	TP 99/C	502	1	12
14622703CB	DN 15 1/2	WHITE-CHROME	TR 91/AC	TP 98/C	TP 99/C	507	1	12
14622703B	DN 15 1/2	WHITE	TR 91/AC	TP 98/C	TP 99/C	507	1	12
14622703N	DN 15 1/2	BLACK	TR 91/AC	TP 98/C	TP 99/C	561	1	12

Kit with fittings included.

CODE	SIZE	FINISH			
14010004	DN 15 1/2	CHROME	503	1	12
14010004CB	DN 15 1/2	WHITE-CHROME	507	1	12

CODE	SIZE	FINISH			
14010004B	DN 15 1/2	WHITE	507	1	12

CODE	SIZE	FINISH			
14010004N	DN 15 1/2	BLACK	507	1	12

	Fitting	Code	Size
2x	TR 91/AC	67761200C	12 mm
2x	TR 91/AC	67761400C	14 mm
2x	TP 99/C	67861612C	16x2
2x	TR 91/AC	67761200B	12 mm
2x	TR 91/AC	67761400B	14 mm
2x	TP 99/C	67861612B	16x2
2x	TR 91/AC	67761200N	12 mm
2x	TR 91/AC	67761400N	14 mm
2x	TP 99/C	67861612N	16x2



Fittings for copper pipe



Fittings for plastic pipe



Fittings for multilayer pipe



Fittings: chapter 7



Accessories: chapter 1.A



CHROME



WHITE-CHROME
ARTICLE DISCONTINUED



WHITE



BLACK

KT 69/A

Complete coaxial right manual kit for radiator connection. Consisting of RCD 69/A + DCS 33/A. Eurokonus connection.

CODE	SIZE	FINISH						
14692703	DN 15 1/2	CHROME	TR 91/AC	TP 98/C	TP 99/C	561	1	12
14692703CB	DN 15 1/2	WHITE-CHROME	TR 91/AC	TP 98/C	TP 99/C	564	1	12
14692703B	DN 15 1/2	WHITE	TR 91/AC	TP 98/C	TP 99/C	564	1	12
14692703N	DN 15 1/2	BLACK	TR 91/AC	TP 98/C	TP 99/C	564	1	12

Kit with fittings included.

CODE	SIZE	FINISH			
14010005	DN 15 1/2	CHROME	503	1	12
14010005CB	DN 15 1/2	WHITE-CHROME	507	1	12

CODE	SIZE	FINISH			
14010005B	DN 15 1/2	WHITE	507	1	12

CODE	SIZE	FINISH			
14010005N	DN 15 1/2	BLACK	507	1	12

	Fitting	Code	Size
2x	TR 91/AC	67761200C	12 mm
2x	TR 91/AC	67761400C	14 mm
2x	TP 99/C	67861612C	16x2
2x	TR 91/AC	67761200B	12 mm
2x	TR 91/AC	67761400B	14 mm
2x	TP 99/C	67861612B	16x2
2x	TR 91/AC	67761200N	12 mm
2x	TR 91/AC	67761400N	14 mm
2x	TP 99/C	67861612N	16x2



CHROME



WHITE-CHROME
ARTICLE DISCONTINUED



WHITE



BLACK

KT 73/A

Complete coaxial left manual kit for radiator connection. Consisting of RCS 73/A + DCD 29/A. Eurokonus connection.

CODE	SIZE	FINISH						
14712703	DN 15 1/2	CHROME	TR 91/AC	TP 98/C	TP 99/C	561	1	12
14712703CB	DN 15 1/2	WHITE-CHROME	TR 91/AC	TP 98/C	TP 99/C	564	1	12
14712703B	DN 15 1/2	WHITE	TR 91/AC	TP 98/C	TP 99/C	564	1	12
14712703N	DN 15 1/2	BLACK	TR 91/AC	TP 98/C	TP 99/C	564	1	12

Kit with fittings included.

CODE	SIZE	FINISH			
14010006	DN 15 1/2	CHROME	503	1	12
14010006CB	DN 15 1/2	WHITE-CHROME	507	1	12

CODE	SIZE	FINISH			
14010006B	DN 15 1/2	WHITE	507	1	12

CODE	SIZE	FINISH			
14010006N	DN 15 1/2	BLACK	507	1	12

	Fitting	Code	Size
2x	TR 91/AC	67761200C	12 mm
2x	TR 91/AC	67761400C	14 mm
2x	TP 99/C	67861612C	16x2
2x	TR 91/AC	67761200B	12 mm
2x	TR 91/AC	67761400B	14 mm
2x	TP 99/C	67861612B	16x2
2x	TR 91/AC	67761200N	12 mm
2x	TR 91/AC	67761400N	14 mm
2x	TP 99/C	67861612N	16x2



Fittings for copper pipe



Fittings for plastic pipe



Fittings for multilayer pipe



Fittings: chapter 7



Accessories: chapter 1.A



CHROME



WHITE-CHROME
ARTICLE DISCONTINUED



WHITE

KT 58/A

Complete straight manual kit for radiator connection. Consisting of RD 58/A + DD 78/A. Eurokonus connection.

CODE	SIZE	FINISH						
14822703	DN 15 1/2	CHROME	TR 91/AC	TP 98/C	TP 99/C	566	1	12
14822703CB	DN 15 1/2	WHITE-CHROME	TR 91/AC	TP 98/C	TP 99/C	570	1	12
14822703B	DN 15 1/2	WHITE	TR 91/AC	TP 98/C	TP 99/C	570	1	12

**THERMOSTATISABLE VALVES WITH PRE-REGULATION:
CONNECTION FOR COPPER AND PLASTIC PIPE G3/4 EUROKONUS**



CHROME



WHITE-CHROME
ARTICLE DISCONTINUED

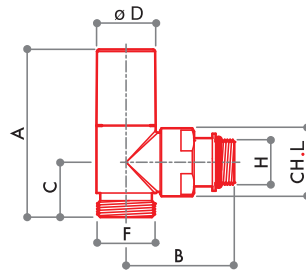

RS 259/A

Angle radiator valve thermostatically or electrically controllable with protection cap. Eurokonus connection.

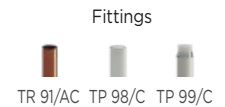

CODE	SIZE	FINISH	A	B	C	D	E	F	G	H	L			
14202703	DN 15 1/2	CHROME	67	50	25	37	-	G 3/4EK	-	G 1/2	28	264	5	60
14202703CB	DN 15 1/2	WHITE-CHROME	67	50	25	37	-	G 3/4EK	-	G 1/2	28	265	5	60



CHROME



WHITE-CHROME
ARTICLE DISCONTINUED

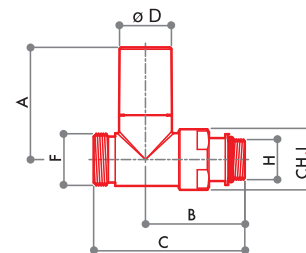

RD 258/A

Straight radiator valve thermostatically or electrically controllable with protection cap. Eurokonus connection.



CODE	SIZE	FINISH	A	B	C	D	E	F	G	H	L			
14402703	DN 15 1/2	CHROME	48	51	78	37	-	G 3/4EK	-	G 1/2	28	292	5	60
14402703CB	DN 15 1/2	WHITE-CHROME	48	51	78	37	-	G 3/4EK	-	G 1/2	28	293	5	60



Fittings for copper pipe



Fittings for plastic pipe



Fittings for multilayer pipe



Fittings: chapter 7



Accessories: chapter 1.A



CHROME



WHITE-CHROME
ARTICLE DISCONTINUED

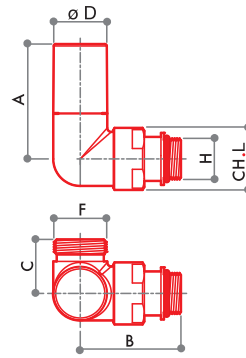

RCD 269/A

Coaxial right radiator valve thermostatically or electrically controllable with protection cap. Eurokonus connection.

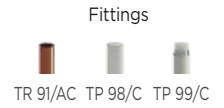

CODE	SIZE	FINISH	A	B	C	D	E	F	G	H	L			
14272703	DN 15 1/2	CHROME	48	51	27	37	-	G3/4EK	-	G1/2	28	287	5	60
14272703CB	DN 15 1/2	WHITE-CHROME	48	51	27	37	-	G3/4EK	-	G1/2	28	289	5	60



CHROME



WHITE-CHROME
ARTICLE DISCONTINUED

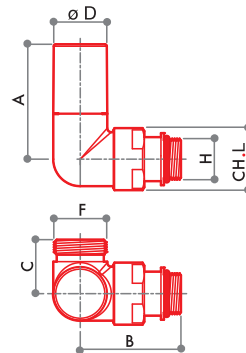

RCS 273/A

Coaxial left radiator valve thermostatically or electrically controllable with protection cap. Eurokonus connection.

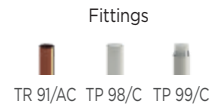

CODE	SIZE	FINISH	A	B	C	D	E	F	G	H	L			
14292703	DN 15 1/2	CHROME	48	51	27	37	-	G3/4EK	-	G1/2	28	287	5	60
14292703CB	DN 15 1/2	WHITE-CHROME	48	51	27	37	-	G3/4EK	-	G1/2	28	289	5	60



CHROME



WHITE-CHROME
ARTICLE DISCONTINUED



WHITE



BLACK

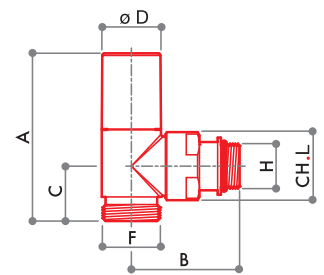

RS 2059/A

Angle radiator valve thermostatically or electrically controllable with manual adjustment knob. Eurokonus connection.



CODE	SIZE	FINISH	A	B	C	D	E	F	G	H	L			
14242703	DN 15 1/2	CHROME	83	50	25	35	-	G 3/4EK	-	G 1/2	28	278	5	60
14242703CB	DN 15 1/2	WHITE-CHROME	83	50	25	35	-	G 3/4EK	-	G 1/2	28	278	5	60
14242703B	DN 15 1/2	WHITE	83	50	25	35	-	G 3/4EK	-	G 1/2	28	278	5	60
14242703N	DN 15 1/2	BLACK	83	50	25	35	-	G 3/4EK	-	G 1/2	28	278	5	60



CHROME



WHITE-CHROME
ARTICLE DISCONTINUED



WHITE



BLACK

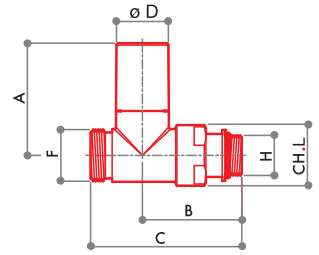

RD 2058/A

Straight radiator valve thermostatically or electrically controllable with manual adjustment knob. Eurokonus connection.

Fittings



CODE	SIZE	FINISH	A	B	C	D	E	F	G	H	L			
14442703	DN 15 1/2	CHROME	64	51	78	35	-	G 3/4EK	-	G 1/2	28	305	5	60
14442703CB	DN 15 1/2	WHITE-CHROME	64	51	78	35	-	G 3/4EK	-	G 1/2	28	306	5	60
14442703B	DN 15 1/2	WHITE	64	51	78	35	-	G 3/4EK	-	G 1/2	28	306	5	60
14442703N	DN 15 1/2	BLACK	64	51	78	35	-	G 3/4EK	-	G 1/2	28	306	5	60



CHROME



WHITE-CHROME
ARTICLE DISCONTINUED



WHITE



BLACK

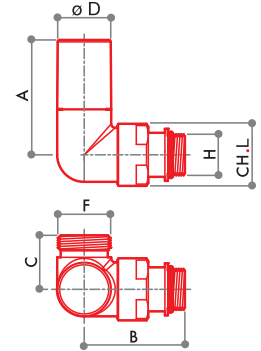

RCD 2069/A

Coaxial right radiator valve thermostatically or electrically controllable with manual adjustment knob. Eurokonus connection.

Fittings



CODE	SIZE	FINISH	A	B	C	D	E	F	G	H	L			
14312703	DN 15 1/2	CHROME	64	51	27	35	-	G3/4EK	-	G1/2	28	300	5	60
14312703CB	DN 15 1/2	WHITE-CHROME	64	51	27	35	-	G3/4EK	-	G1/2	28	303	5	60
14312703B	DN 15 1/2	WHITE	64	51	27	35	-	G3/4EK	-	G1/2	28	303	5	60
14312703N	DN 15 1/2	BLACK	64	51	27	35	-	G3/4EK	-	G1/2	28	303	5	60



CHROME



WHITE-CHROME
ARTICLE DISCONTINUED



WHITE



BLACK

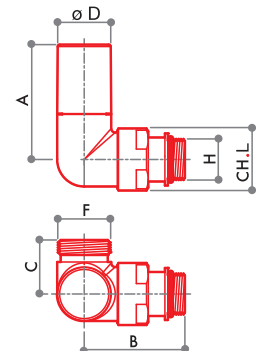

RCS 2073/A

Coaxial left radiator valve thermostatically or electrically controllable with manual adjustment knob. Eurokonus connection.

Fittings



CODE	SIZE	FINISH	A	B	C	D	E	F	G	H	L			
14332703	DN 15 1/2	CHROME	64	51	27	35	-	G3/4EK	-	G1/2	28	300	5	60
14332703CB	DN 15 1/2	WHITE-CHROME	64	51	27	35	-	G3/4EK	-	G1/2	28	303	5	60
14332703B	DN 15 1/2	WHITE	64	51	27	35	-	G3/4EK	-	G1/2	28	303	5	60
14332703N	DN 15 1/2	BLACK	64	51	27	35	-	G3/4EK	-	G1/2	28	303	5	60



Fittings for copper pipe



Fittings for plastic pipe



Fittings for multilayer pipe



Fittings: chapter 7



Accessories: chapter 1.A

MANUAL VALVES: CONNECTION FOR COPPER AND PLASTIC PIPE G3/4 EUROKONUS



CHROME



WHITE-CHROME
ARTICLE DISCONTINUED



WHITE



BLACK

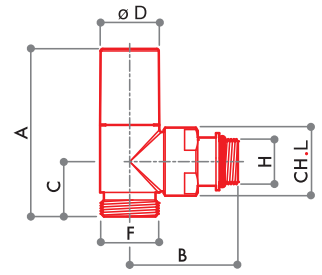

RS 59/A

Single adjustment angle radiator valve.
Eurokonus connection.

Fittings

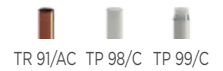

CODE	SIZE	FINISH	A	B	C	D	E	F	G	H	L			
14122703	DN 15 1/2	CHROME	77	50	25	27	-	G 3/4EK	-	G 1/2	28	278	5	60
14122703CB	DN 15 1/2	WHITE-CHROME	77	50	25	27	-	G 3/4EK	-	G 1/2	28	278	5	60
14122703B	DN 15 1/2	WHITE	77	50	25	27	-	G 3/4EK	-	G 1/2	28	278	5	60
14122703N	DN 15 1/2	BLACK	77	50	25	27	-	G 3/4EK	-	G 1/2	28	278	5	60



CHROME



WHITE-CHROME
ARTICLE DISCONTINUED



WHITE



BLACK

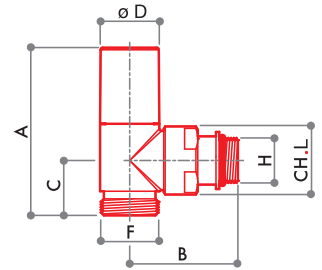

DS 79/A

Angle regulating lockshield.
Eurokonus connection.

Fittings



CODE	SIZE	FINISH	A	B	C	D	E	F	G	H	L			
14162703	DN 15 1/2	CHROME	62	50	25	27	-	G 3/4EK	-	G 1/2	28	224	5	60
14162703CB	DN 15 1/2	WHITE-CHROME	62	50	25	27	-	G 3/4EK	-	G 1/2	28	229	5	60
14162703B	DN 15 1/2	WHITE	62	50	25	27	-	G 3/4EK	-	G 1/2	28	229	5	60
14162703N	DN 15 1/2	BLACK	62	50	25	27	-	G 3/4EK	-	G 1/2	28	229	5	60



CHROME



WHITE-CHROME
ARTICLE DISCONTINUED



WHITE

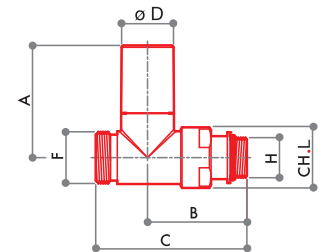

RD 58/A

Single adjustment straight radiator valve.
Eurokonus connection.

Fittings

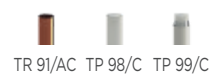

CODE	SIZE	FINISH	A	B	C	D	E	F	G	H	L			
14322703	DN 15 1/2	CHROME	58	51	78	27	-	G 3/4EK	-	G 1/2	28	305	5	60
14322703CB	DN 15 1/2	WHITE-CHROME	58	51	78	27	-	G 3/4EK	-	G 1/2	28	309	5	60
14322703B	DN 15 1/2	WHITE	58	51	78	27	-	G 3/4EK	-	G 1/2	28	309	5	60



CHROME



WHITE-CHROME
ARTICLE DISCONTINUED



WHITE



BLACK

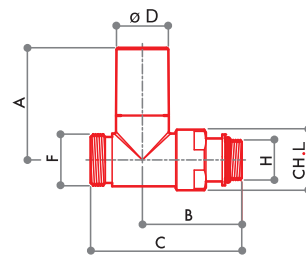

DD 78/A

Straight regulating lockshield.
Eurokonus connection.

Fittings



CODE	SIZE	FINISH	A	B	C	D	E	F	G	H	L			
14362703	DN 15 1/2	CHROME	42	51	78	27	-	G 3/4EK	-	G 1/2	28	260	5	60
14362703CB	DN 15 1/2	WHITE-CHROME	42	51	78	27	-	G 3/4EK	-	G 1/2	28	567	5	60
14362703B	DN 15 1/2	WHITE	42	51	78	27	-	G 3/4EK	-	G 1/2	28	567	5	60
14362703N	DN 15 1/2	BLACK	42	51	78	27	-	G 3/4EK	-	G 1/2	28	567	5	60



CHROME



WHITE-CHROME
ARTICLE DISCONTINUED



WHITE



BLACK

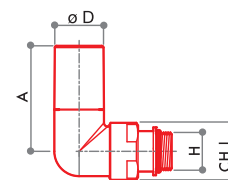

RCD 69/A

Single adjustment coaxial right radiator
valve. Eurokonus connection.

Fittings



CODE	SIZE	FINISH	A	B	C	D	E	F	G	H	L			
14192703	DN 15 1/2	CHROME	58	51	27	27	-	G3/4EK	-	G1/2	28	304	5	60
14192703CB	DN 15 1/2	WHITE-CHROME	58	51	27	27	-	G3/4EK	-	G1/2	28	306	5	60
14192703B	DN 15 1/2	WHITE	58	51	27	27	-	G3/4EK	-	G1/2	28	306	5	60
14192703N	DN 15 1/2	BLACK	58	51	27	27	-	G3/4EK	-	G1/2	28	306	5	60



CHROME



WHITE-CHROME
ARTICLE DISCONTINUED



WHITE



BLACK

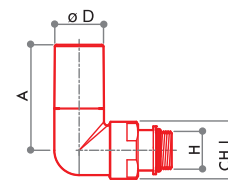

DCS 33/A

Single adjustment coaxial left regulating
lockshield. Eurokonus connection.

Fittings



CODE	SIZE	FINISH	A	B	C	D	E	F	G	H	L			
14252703	DN 15 1/2	CHROME	42	51	27	27	-	G3/4EK	-	G1/2	28	258	5	60
14252703CB	DN 15 1/2	WHITE-CHROME	42	51	27	27	-	G3/4EK	-	G1/2	28	258	5	60
14252703B	DN 15 1/2	WHITE	42	51	27	27	-	G3/4EK	-	G1/2	28	258	5	60
14252703N	DN 15 1/2	BLACK	42	51	27	27	-	G3/4EK	-	G1/2	28	258	5	60



Fittings for copper pipe



Fittings for plastic pipe



Fittings for multilayer pipe



Fittings: chapter 7



Accessories: chapter 1.A



CHROME



WHITE-CHROME
ARTICLE DISCONTINUED



WHITE



BLACK

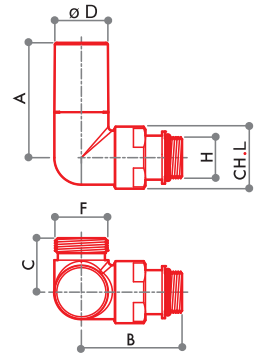

RCS 73/A

Single adjustment coaxial left radiator valve. Eurokonus connection.

Fittings



CODE	SIZE	FINISH	A	B	C	D	E	F	G	H	L			
14212703	DN 15 1/2	CHROME	58	51	27	27	-	G3/4EK	-	G1/2	28	304	5	60
14212703CB	DN 15 1/2	WHITE-CHROME	58	51	27	27	-	G3/4EK	-	G1/2	28	306	5	60
14212703B	DN 15 1/2	WHITE	58	51	27	27	-	G3/4EK	-	G1/2	28	306	5	60
14212703N	DN 15 1/2	BLACK	58	51	27	27	-	G3/4EK	-	G1/2	28	306	5	60



CHROME



WHITE-CHROME
ARTICLE DISCONTINUED



WHITE



BLACK

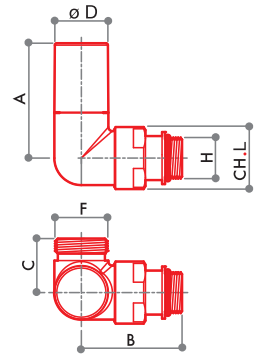

DCD 29/A

Single adjustment coaxial right regulating lockshield. Eurokonus connection.

Fittings



CODE	SIZE	FINISH	A	B	C	D	E	F	G	H	L			
14232703	DN 15 1/2	CHROME	42	51	27	27	-	G3/4EK	-	G1/2	28	258	5	60
14232703CB	DN 15 1/2	WHITE-CHROME	42	51	27	27	-	G3/4EK	-	G1/2	28	258	5	60
14232703B	DN 15 1/2	WHITE	42	51	27	27	-	G3/4EK	-	G1/2	28	258	5	60
14232703N	DN 15 1/2	BLACK	42	51	27	27	-	G3/4EK	-	G1/2	28	258	5	60

SINGLE/DOUBLE PIPE VALVES



CHROME



WHITE



BLACK

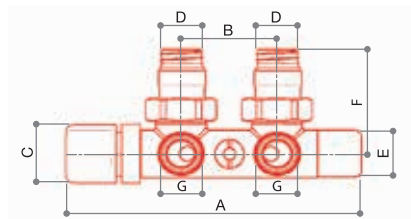

MT 2590/A

Single/double pipe thermostatic valve with manual adjustment knob. Adjustable bypass valve. Eurokonus connection.

Fittings



CODE	SIZE	FINISH	A	B	C	D	E	F	G			
14002703	DN 15 1/2	CHROME	153	50	34	G1/2	26	52	G3/4EK	657	1	10
14002703B	DN 15 1/2	WHITE	153	50	34	G1/2	26	52	G3/4EK	657	1	10
14002703N	DN 15 1/2	BLACK	153	50	34	G1/2	26	52	G3/4EK	657	1	10

TT 3000C

THERMOSTATIC HEAD



TECHNICAL DATA

Max temperature	Max pressure	Max differential pressure
120 °C	10 bar	0,6 bar

Min. adjustment temperature (anti-freeze pos.)

Ts min 6 °C

Max regulation temperature (max position)

Ts max 30 °C (5)

Energy saving conditions

20 °C

Thermostatic element inalterability range

-15 °C ÷ 60 °C

Storage temperature

-20 °C ÷ + 50 °C

Hysteresis

C 0,4 k

Differential pressure influence

D 0,5 k

Water temperature influence

W 0,25 k

Response time

Z 22 min.

Control Accuracy

CA 0,2 K.

VALVE CONNECTION



M 30 x 1,5

**FOR MORE INFORMATION
PLEASE REFER TO CHAPTER
THERMOTEKNA**

CONSTRUCTIVE FEATURES

Thermostatic heads consist of a sensor filled with a highly expandable element. This element, which may be incorporated in the adjustment knob or in the remote sensor, expands or contracts in proportion to room temperature changes, reacting even to the smallest variation. When the surrounding

temperature increases, the element expands and acts on the obturator with an axial thrust movement, thus controlling the valve action. The flow of the heating medium can be adjusted by opening and closing the valve.

THERMOSTATIC HEAD WITH INTEGRATED CONTROL AND SENSOR



CHROME



WHITE-CHROME



BLACK

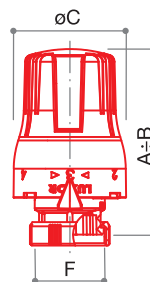

TT 3000

Thermostatic head with integrated control and sensor.

CODE	SIZE	FINISH	A	B	C	D	E	F	G	H	L			
69100000C	M30x1,5	CHROME	75	80	46,5	-	-	M30x1,5	-	-	-	110	1	100
69100000CB	M30x1,5	WHITE-CHROME	75	80	46,5	-	-	M30x1,5	-	-	-	110	1	100
69100000N	M30x1,5	BLACK	75	80	46,5	-	-	M30x1,5	-	-	-	110	1	100

VALVES FLOW RATE CHART

MANUAL VALVE

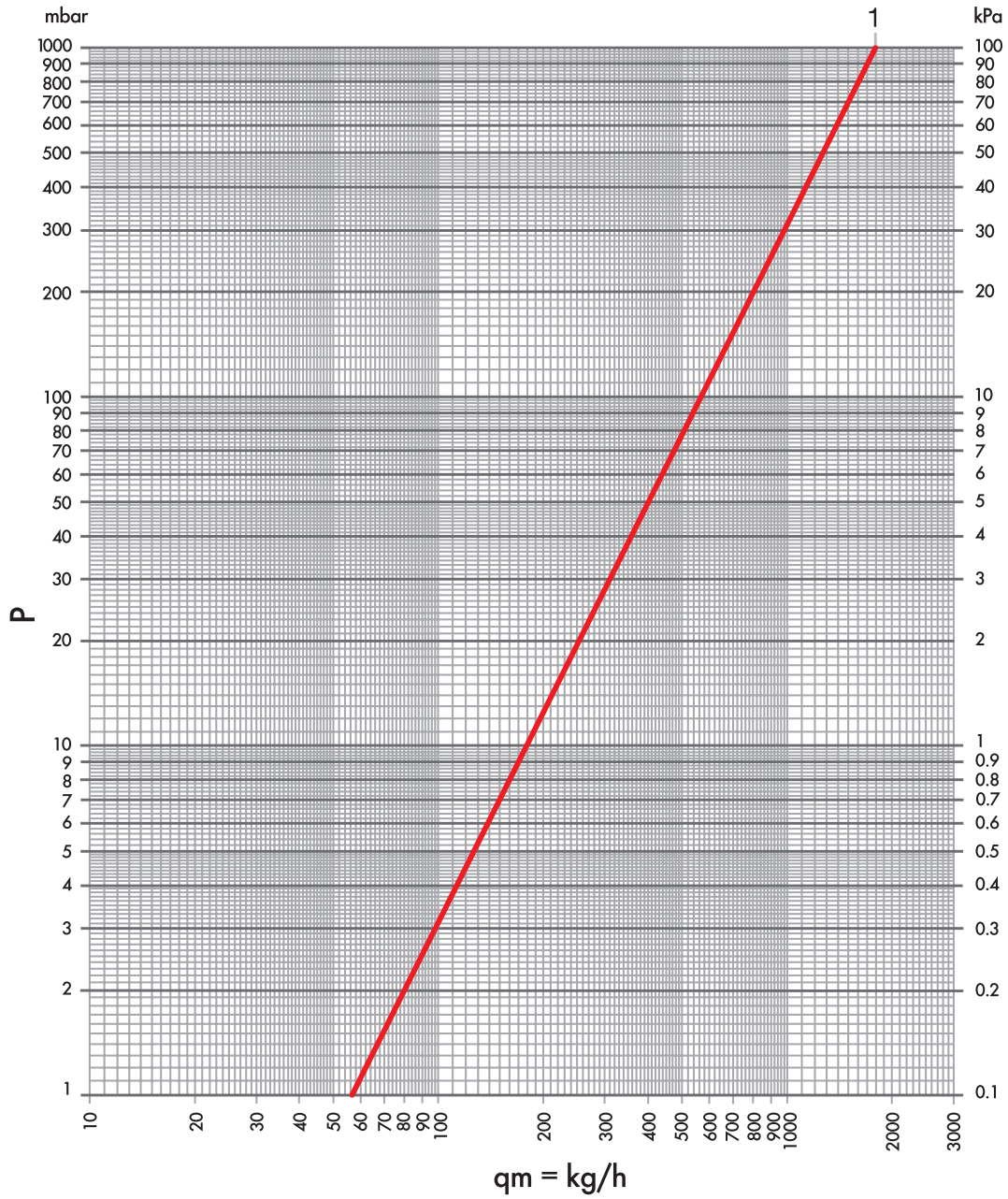

ITEM	LOOP N°	Kv	POS
RD 58/A 1/2 RS 59/A 1/2 RCD 69/A 1/2 RCS 73/A 1/2	1	1,85	1

VALVES FLOW RATE CHART

THERMO VALVES

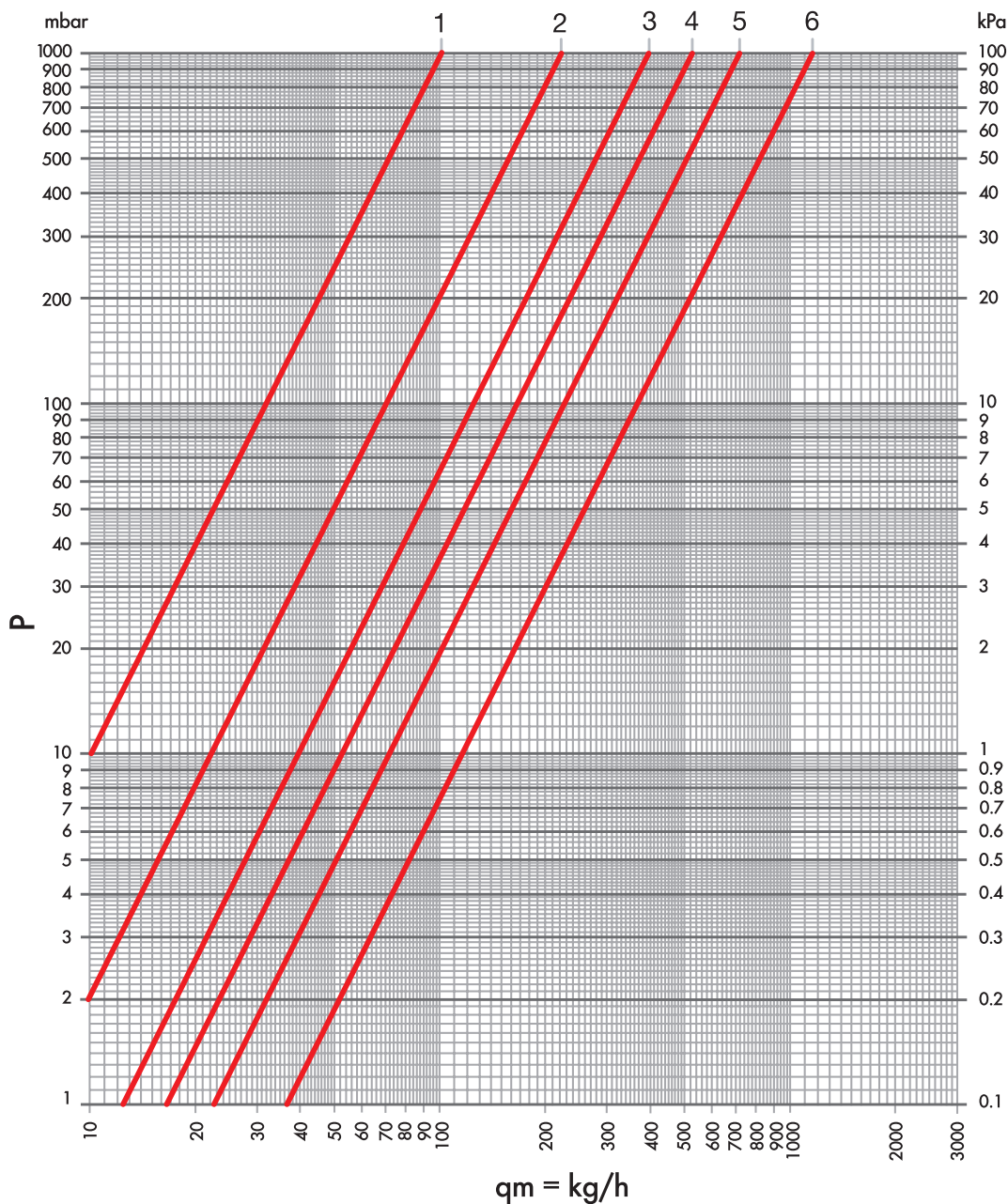

ITEM	Kv	Kv Δt 1 °C	Kv Δt 2 °C	POS
RD 258/A RS 259/A RCD 269/A RCS 273/A RD 2058/A RS 2059/A RCD 2069/A RCS 2073/A	0,10	0,11	0,15	1
	0,22	0,16	0,25	2
	0,39	0,18	0,36	3
	0,52	0,18	0,37	4
	0,71	0,19	0,43	5
	1,25	0,20	0,50	6

LOCKSHIELD FLOW RATE CHART

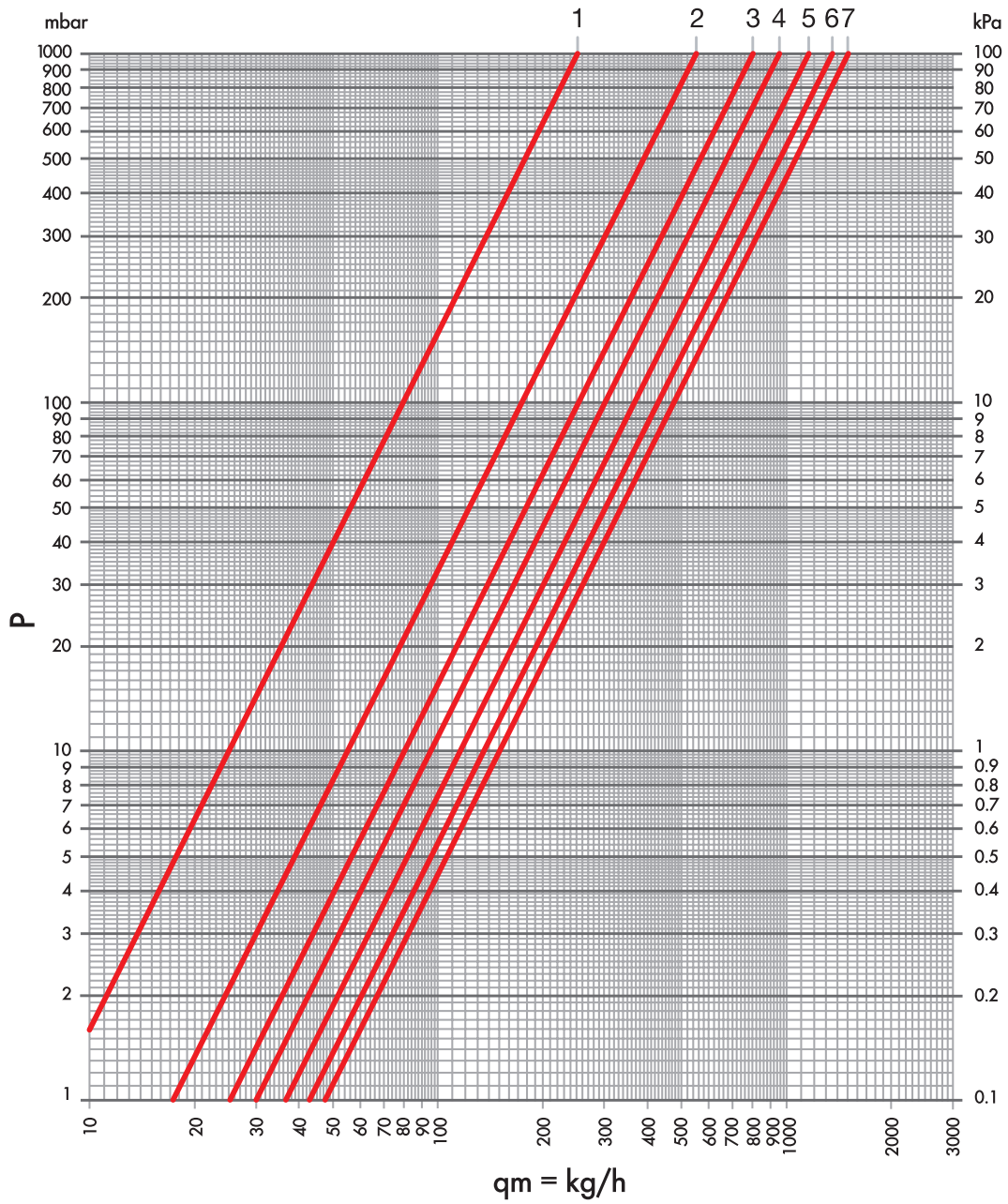

ITEM	LOOP N°	Kv	POS
DD 78/A DS 79/A DCD 29/A DCS 33/A	1	0,25	1
	1+1/2	0,55	2
	2	0,80	3
	2+1/2	0,95	4
	3	1,15	5
	3+1/2	1,35	6
	all open	1,50	7



LUXOR®

RADIATOR VALVES

1.5 / M-MT

M

4-WAY MANUAL VALVES FOR SINGLE PIPE DISTRIBUTION SYSTEM



Single pipe valves feature a fixed stem, whose tightness is ensured by an o-ring and a flat teflon gasket which may be adjusted through a brass stuffing nut. The valves are nickel plated.

TECHNICAL DATA



DN
15
20



Max temperature
120 °C



Max pressure
10 bar



Max differential pressure
1 bar



Materials
CW617N
UNI EN
12165:2016



Knob
white ABS
RAL 9016



Probe
Polyamide

SYSTEM CONNECTIONS

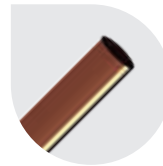

Copper pipe
W 24x19 - TR 91



Plastic pipe
W 24x19 - TP 95



Multilayer pipe
W 24x19 - TP 97

RADIATOR CONNECTION

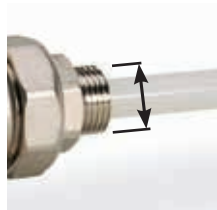

cylindrical thread
G 1/2
G 3/4

CENTRE TO CENTRE DISTANCE



40 mm

PROBE

4-way M valves are provided with a M 523 polyamide probe which enables them to correctly distribute the flow in heating bodies up to 50 cm in length. Should the direction of flow indicated by the arrow on the body not be observed,

or should the heating body be longer than 50 cm, a M 525 polyamide extension must be installed and then cut so that the other end is located 10 cm far from the edge of the heating body.



The characteristics of the fluid in the system must be compliant with the UNI 8065: 2019 directive.

4-WAY MANUAL VALVES FOR SINGLE PIPE DISTRIBUTION SYSTEM M 87

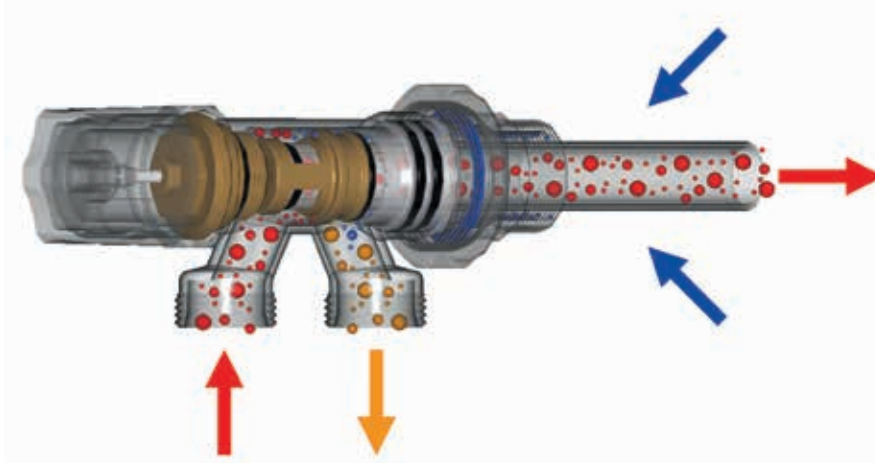

Luxor manufactures 4-way manual valves for single and double pipe systems which easily meet any requirement. All 4-way valves are designed so that the heating medium can flow in and out of the heating body through a single connection. These valves must be installed on the bottom connection of the heating body. 4-way valves for single and double pipe systems are designed to:

- Connect the heating body to the single pipe ring tubing, which can be in copper, plastic or PEX-AL-PEX multilayer;
- Allow for room temperature setting by adjusting the inlet flow;
- Intercept the flow so as to allow for maintenance without affecting the functioning of the remaining heating bodies.

The valve divides the incoming flow into two: one part enters the heating body, while the other flows on to the next heating body through the bypass. The advantage is that the flow coming out of a low temperature heating body mixes with the flow which has passed through the bypass and has a higher temperature; in this way, the flow proceeding towards the next heating body will have a higher thermal input.

M 87 valves are equipped with a fixed bypass allowing 50% of the ring flow rate to enter the heating body.

4-WAY MANUAL VALVES FOR SINGLE/DOUBLE PIPE DISTRIBUTION SYSTEM M 88

When in fully open position, M 88 valves do not divert the flow, so that 100% of the ring flow enters the heating body (see picture above).

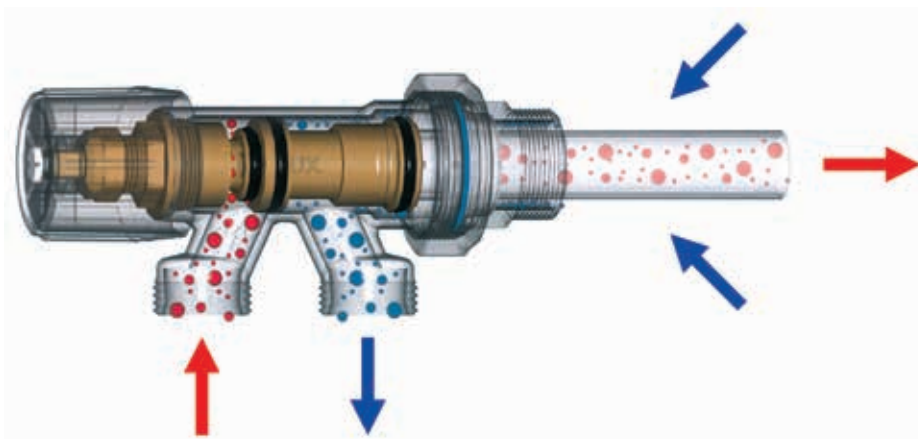

The bypass opens gradually and proportionally to the closure of the obturator (see picture below).

When in fully closed position, the bypass does not allow any liquid to enter the heating body.

The other features are the same as for the manual valve M87 for single pipe distribution system.

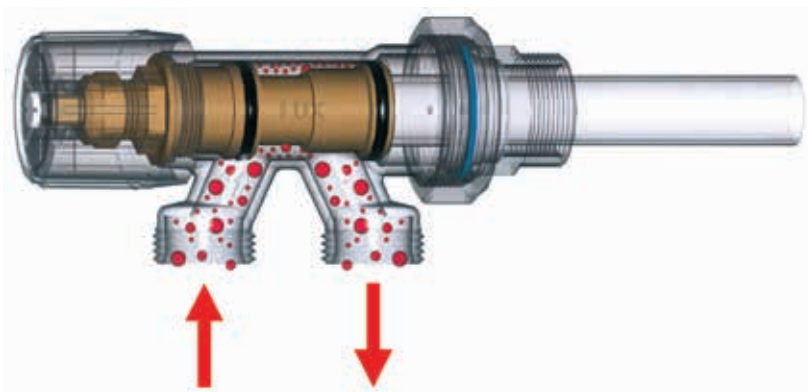

4-WAY VERTICAL MANUAL VALVES FOR SINGLE PIPE DISTRIBUTION SYSTEM M 81-83-85

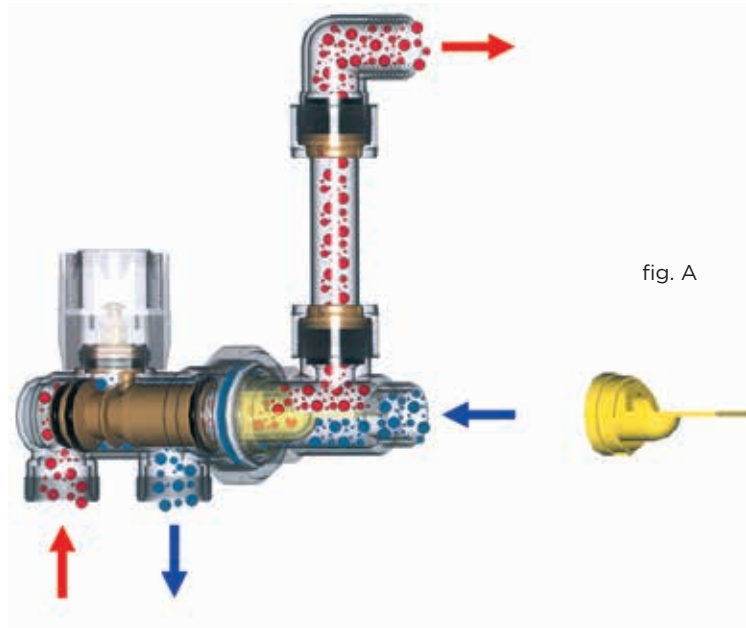

4-way vertical manual valves are available in two versions: single pipe with a 50% bypass or double pipe with 100% of the ring flow rate. The valves must be connected to the system observing the direction indicated by the arrows on the body. In this way, the valves can heat up heating bodies with up to 7-8 elements. Should the flow direction not be respected or should the heating body be composed of more than 8 elements, a M 525 extension must be installed on valves M 81 and M 83.

The extension must then be cut so that the other end is located 10 cm far from the edge of the heating body. If the flow direction is not observed with valves M 85 and M 86, it is necessary to correct it by turning the baffle inside the conveyor body. Use the baffle as shown in fig. A to let the flow enter through the connection as displayed by the arrow.

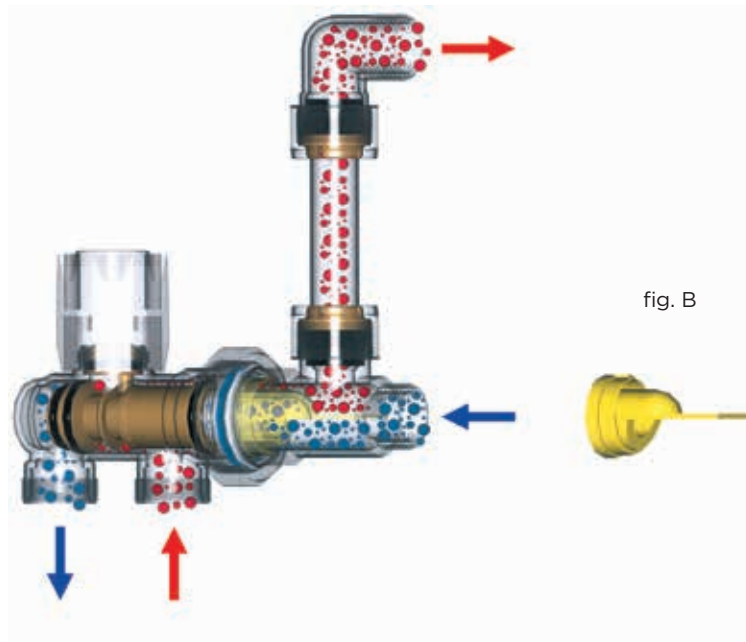

Should the arrow direction not be observed during installation, use the baffle as shown in fig. B.

**4-WAY MANUAL VALVES FOR SINGLE PIPE DISTRIBUTION SYSTEM:
CONNECTION FOR COPPER AND PLASTIC PIPE W24X19**

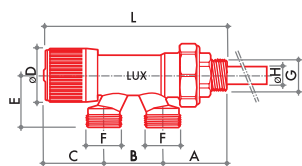

M 87

4-way single adjustment horizontal manual single pipe valve. Maximum flow to radiator: 50% ring flow. Connections for copper and plastic pipe.

Fittings



CODE	SIZE	A	B	C	D	E	F	G	H	L			
68072100	DN 15 1/2	45	40	41	37	35	W24x19	G 1/2	12	126	360	5	40
68072700	DN 20 3/4	45	40	41	37	35	W24x19	G 3/4	16	126	358	5	40

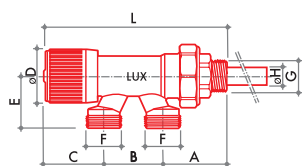

M 88

4-way single adjustment horizontal manual single pipe valve (for double pipe systems). Maximum flow to radiator: 100% ring flow. Connections for copper and plastic pipe.

Fittings

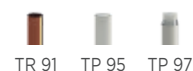

CODE	SIZE	A	B	C	D	E	F	G	H	L			
68072101	DN 15 1/2	45	40	41	37	35	W24x19	G 1/2	12	126	366	5	40
68072701	DN 20 3/4	45	40	41	37	35	W24x19	G 3/4	16	126	363	5	40

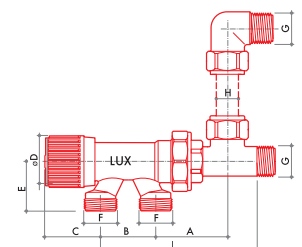

M 86

Single adjustment horizontal straight single pipe valve, with flow conveyor. Maximum flow to radiator: 50% and 100% ring flow. Connections for copper and plastic pipe.

Fittings

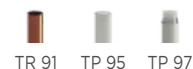

CODE	SIZE	A	B	C	D	E	F	G	H	L			
68072102	DN 15 1/2 50%	52	40	41	37	35	W24x19	G 1/2	15	110	488	5	40
68072103	DN 15 1/2 100%	52	40	41	37	35	W24x19	G 1/2	15	110	490	5	40

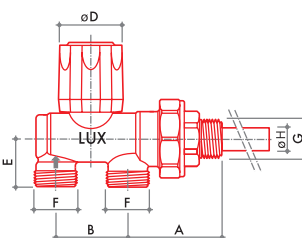

M 81

Single adjustment vertical manual single pipe valve. Maximum flow to radiator: 50% ring flow. Connections for copper and plastic pipe.

Fittings



CODE	SIZE	A	B	C	D	E	F	G	H	L			
68032101	DN 15 1/2	50	40	-	35	27	W24x19	G 1/2	12	-	344	5	40
68032701	DN 20 3/4	50	40	-	35	27	W24x19	G 3/4	16	-	346	5	40



Fittings for copper pipe



Fittings for plastic pipe



Fittings for multilayer pipe



Fittings: chapter 7



Accessories: chapter 1.A

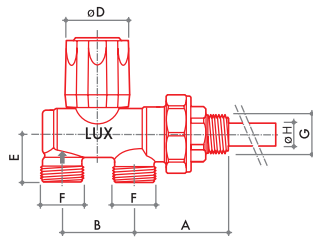

M 83

Single adjustment vertical manual single pipe valve. Maximum flow to radiator: 100% ring flow. Connections for copper and plastic pipe.

Fittings



CODE	SIZE	A	B	C	D	E	F	G	H	L			
68042100	DN 15 1/2	50	40	-	35	27	W24x19	G 1/2	12	-	346	5	40
68042700	DN 20 3/4	50	40	-	35	27	W24x19	G 3/4	16	-	348	5	40

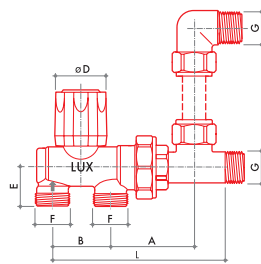

M 85

Single adjustment vertical straight single pipe valve, with flow conveyor. Maximum flow to radiator: 50% and 100% ring flow. Connections for copper and plastic pipe.

Fittings



CODE	SIZE	A	B	C	D	E	F	G	H	L			
68042102	DN 15 1/2 50%	57	40	-	35	27	W24x19	G 1/2	15	114	552	5	40
68042103	DN 15 1/2 100%	57	40	-	35	27	W24x19	G 1/2	15	114	555	5	40

VALVES FLOW RATE CHART

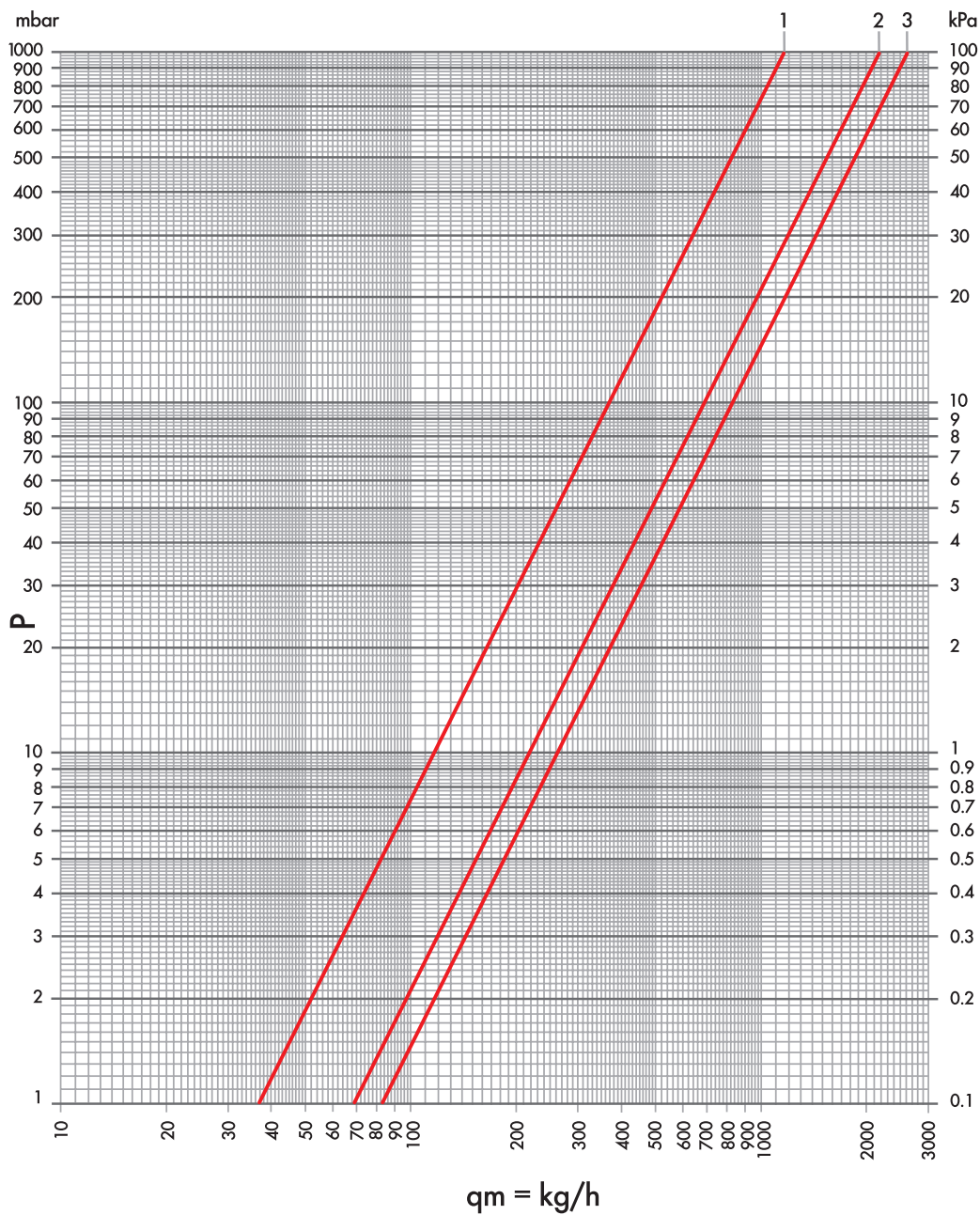

ITEM	Kv	POS
M 88 1/2 M 88 3/4 M 86 1/2 100%	1.61	1
M 83 1/2 M 83 3/4 M 85 1/2 100%	2.16	2
M 87 1/2 M 87 3/4 M 86 1/2 50% M 81 1/2 M 81 3/4 M 85 1/2 50%	2.60	3

MT

4-WAY THERMOSTATIC VALVES FOR SINGLE PIPE DISTRIBUTION SYSTEM



With $\Delta t=2K$ and if coupled with a thermostatic head, thermostatic single pipe valves can supply an heating body with the equivalent of 35% of the system's total flow rate.

The thermostatic screw allows to replace one of the o-rings on the control stem without draining the system. The valves are nickel plated.

TECHNICAL DATA



DN

15
20



Max temperature

120 °C



Max pressure

10 bar



Max differential pressure
1 bar



Materials

CW617N
UNI EN
12165:2016



Knob

white ABS
RAL 9016



Stem

AISI 316



Probe

Polyamide

SYSTEM CONNECTIONS

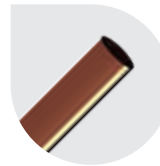

Copper pipe
W 24x19 - TR 91



Plastic pipe
W 24x19 - TP 95



Multilayer pipe
W 24x19 - TP 97

RADIATOR CONNECTION

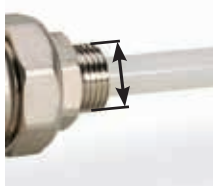

cylindrical thread
G 1/2
G 3/4

CENTRE TO CENTRE DISTANCE



40 mm

PROBE

4-way M valves are provided with a M 523 polyamide probe which enables them to correctly distribute the flow in heating bodies up to 50 cm in length. Should the direction of flow indicated by the arrow on the body not be observed,

or should the heating body be longer than 50 cm, a M 525 polyamide extension must be installed and then cut so that the other end is located 10 cm far from the edge of the heating body.



The characteristics of the fluid in the system must be compliant with the UNI 8065: 2019 directive.

**4-WAY THERMOSTATIC VALVES FOR SINGLE PIPE DISTRIBUTION SYSTEM:
CONNECTION FOR COPPER AND PLASTIC PIPE W24X19**

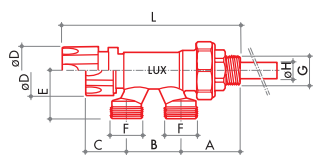

MT 282

4-ways thermostatically or electronically controlled valve with protection cap. Maximum flow to radiator: 35% ring flow ($\Delta t=2K$). Connections for copper and plastic pipe.

Fittings

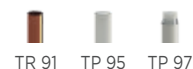

CODE	SIZE	A	B	C	D	E	F	G	H	L			
68010021	DN 15 1/2	46	40	30	37	35	W24x19	G 1/2	12	115	353	5	40
68010027	DN 20 3/4	46	40	30	37	35	W24x19	G 3/4	16	115	351	5	40

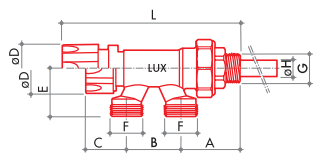

MT 2582

4-ways thermostatically or electronically controlled valve with manual adjustment knob article VT 2600. Maximum flow to radiator: 35% ring flow ($\Delta t=2K$). Connections for copper and plastic pipe.

Fittings



CODE	SIZE	A	B	C	D	E	F	G	H	L			
68010121	DN 15 1/2	46	40	47	35	35	W24x19	G 1/2	12	133	360	5	40
68010127	DN 20 3/4	46	40	47	35	35	W24x19	G 3/4	16	133	360	5	40



Fittings for copper pipe



Fittings for plastic pipe



Fittings for multilayer pipe



Fittings: chapter 7



Accessories: chapter 1.A

VALVES FLOW RATE CHART

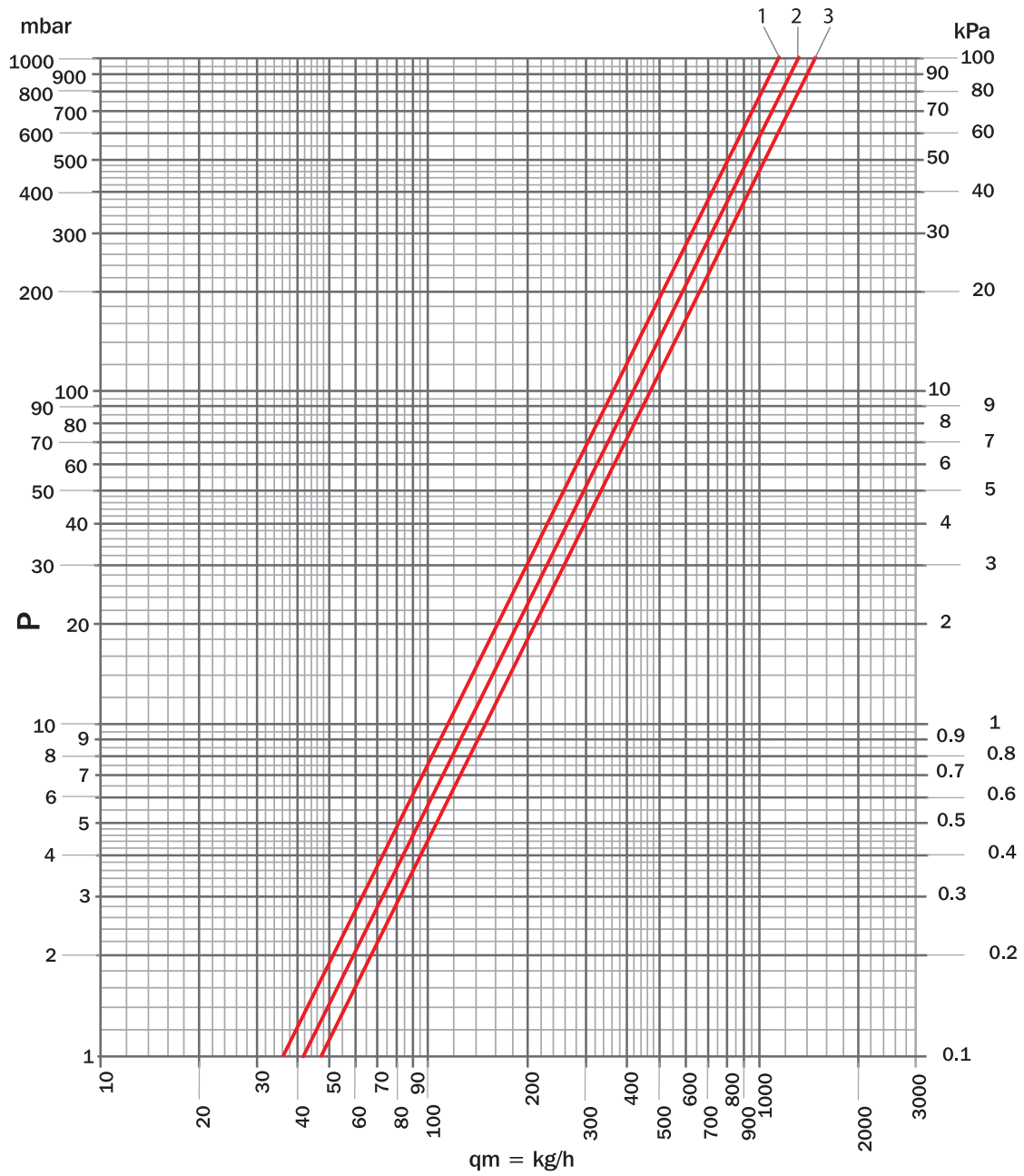

ITEM	SIZE	RA %	URNS N°	Kv	POS
MT 282	DN 15 1/2	0	closed	1,15	1
	DN 20 3/4			1,15	1
	DN 15 1/2	100	all open	1,30	2
	DN 20 3/4			1,45	3
MT 2582	DN 15 1/2	0	closed	1,15	1
	DN 20 3/4			1,15	1
	DN 15 1/2	100	all open	1,30	2
	DN 20 3/4			1,45	3

M

VALVES FOR SINGLE/DOUBLE PIPE DISTRIBUTION SYSTEM



Manual M valves feature a fixed stem, whose tightness is ensured by an o-ring and a flat PTFE gasket which may be adjusted through a brass stuffing nut. When in closed position, the tightness is granted by an o-ring and a conical metal collar. The screw of thermostatic M valves allows to

preset the flow thanks to a shaped acetal ring. The thermostatic screw enables to replace one of the o-rings on the control stem without draining the system. The valves are nickel plated.

TECHNICAL DATA

SYSTEM CONNECTIONS

DN	Max temperature	Max pressure	Max differential pressure (thermostatic valves)	Max differential pressure
15	120 °C	10 bar	0,6 bar	1 bar
Materials	Knob	Stem	Testing	
CW617N UNI EN 12165:2016	white ABS RAL 9016	AISI 316	100%	

Iron pipe G 1/2	Copper pipe W 24x19 - TR 91 G 3/4 EK - TR 91/A
Plastic pipe W 24x19 - TP 95 G 3/4 EK - TP 98	Multilayer pipe W 24x19 - TP 97 G 3/4 EK - TP 99

RADIATOR CONNECTION



conical knurled thread
G 1/2

FLOW ADJUSTMENT AND REVERSE FLOW

To adjust the maximum flow rate, proceed as follows:

- align the reference mark on the stainless steel stem with one of the positions marked on the valve.

Luxor thermostatic valves are now EN 215 approved in reverse flow mode as well. This characteristic allows for installation on the inlet as well as on the outlet of the radiator up to a 0,6 bar differential pressure.



All valves and lockshields are 100% checked with an electronically controlled pneumatic test.

The characteristics of the fluid in the system must be compliant with the UNI 8065: 2019 directive.

**VALVES FOR SINGLE/DOUBLE PIPE DISTRIBUTION SYSTEM:
CONNECTION FOR COPPER AND PLASTIC PIPE W24X19**

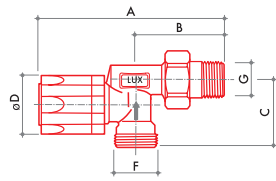

M 300

Single adjustment reverse angle radiator valve. Connection for copper and plastic pipe.

Fittings



CODE	SIZE	A	B	C	D	E	F	G	H	L			
13062100	DN 15 1/2	108	52	39	35	-	W24x19	R 1/2	-	-	215	10	80

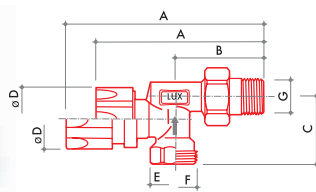

M 320

Reverse angle radiator valve, thermostatically or electronically controlled with protection cap. Connection for copper and plastic pipe.

Fittings



CODE	SIZE	A	B	C	D	E	F	G	H	L			
13102100	DN 15 1/2	95	52	39	37	-	W24x19	R 1/2	-	-	207	10	80

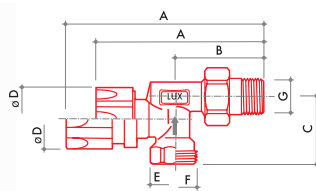

M 330

Reverse angle radiator valve, thermostatically or electronically controlled with manual adjustment knob. Connection for copper and plastic pipe.

Fittings



CODE	SIZE	A	B	C	D	E	F	G	H	L			
13122100	DN 15 1/2	116	52	39	35	-	W24x19	R 1/2	-	-	215	10	80

**VALVES FOR SINGLE/DOUBLE PIPE DISTRIBUTION SYSTEM:
CONNECTION FOR COPPER AND PLASTIC PIPE G3/4 EUROKONUS**

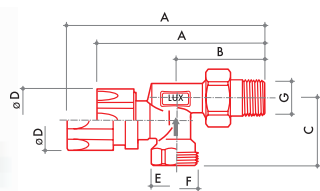

M 320/A

Reverse angle radiator valve, thermostatically or electronically controlled with protection cap. Eurokonus connections.

Fittings



CODE	SIZE	A	B	C	D	E	F	G	H	L			
13102721	DN 15 1/2	95	52	39	37	-	G 3/4 EK	R 1/2	-	-	210	10	80

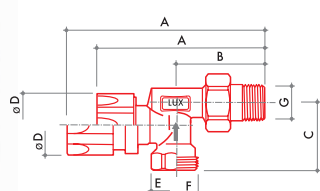

M 330/A

Reverse angle radiator valve, thermostatically or electronically controlled with manual adjustment knob. Eurokonus connections.

Fittings



CODE	SIZE	A	B	C	D	E	F	G	H	L			
13122721	DN 15 1/2	116	52	39	35	-	G 3/4 EK	R 1/2	-	-	217	10	80

**VALVES FOR SINGLE/DOUBLE PIPE DISTRIBUTION SYSTEM:
CONNECTION FOR IRON PIPE**

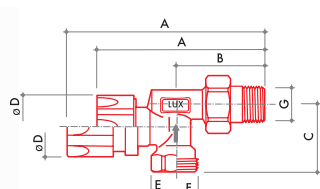

M 322

Reverse angle radiator valve, thermostatically or electronically controlled with protection cap. Connections for iron pipe.

Fittings



CODE	SIZE	A	B	C	D	E	F	G	H	L			
13202100	DN 15 1/2	95	52	40	37	G 1/2	-	R 1/2	-	-	221	10	80

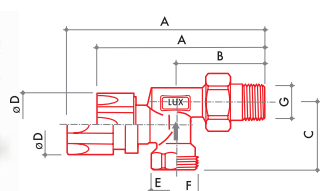

M 332

Reverse angle radiator valve, thermostatically or electronically controlled with manual adjustment knob. Connections for iron pipe.

Fittings



CODE	SIZE	A	B	C	D	E	F	G	H	L			
13222100	DN 15 1/2	116	52	40	35	G 1/2	-	R 1/2	-	-	228	10	80



Fittings for copper pipe



Fittings for plastic pipe



Fittings for multilayer pipe



Fittings: chapter 7



Accessories: chapter 1.A

VALVES FLOW RATE CHART

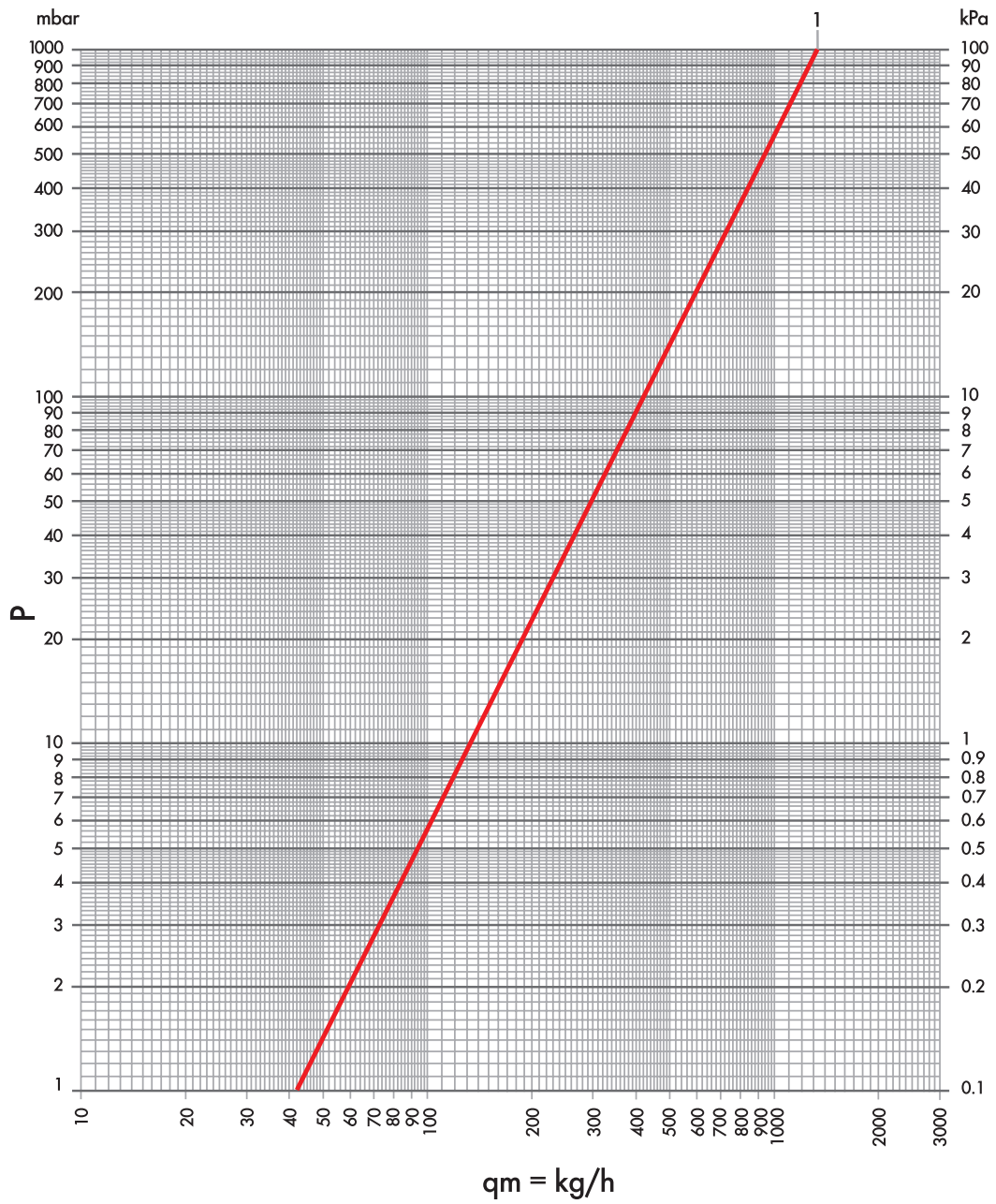

ITEM	Kv	POS
M 300	1.31	1

VALVES FLOW RATE CHART

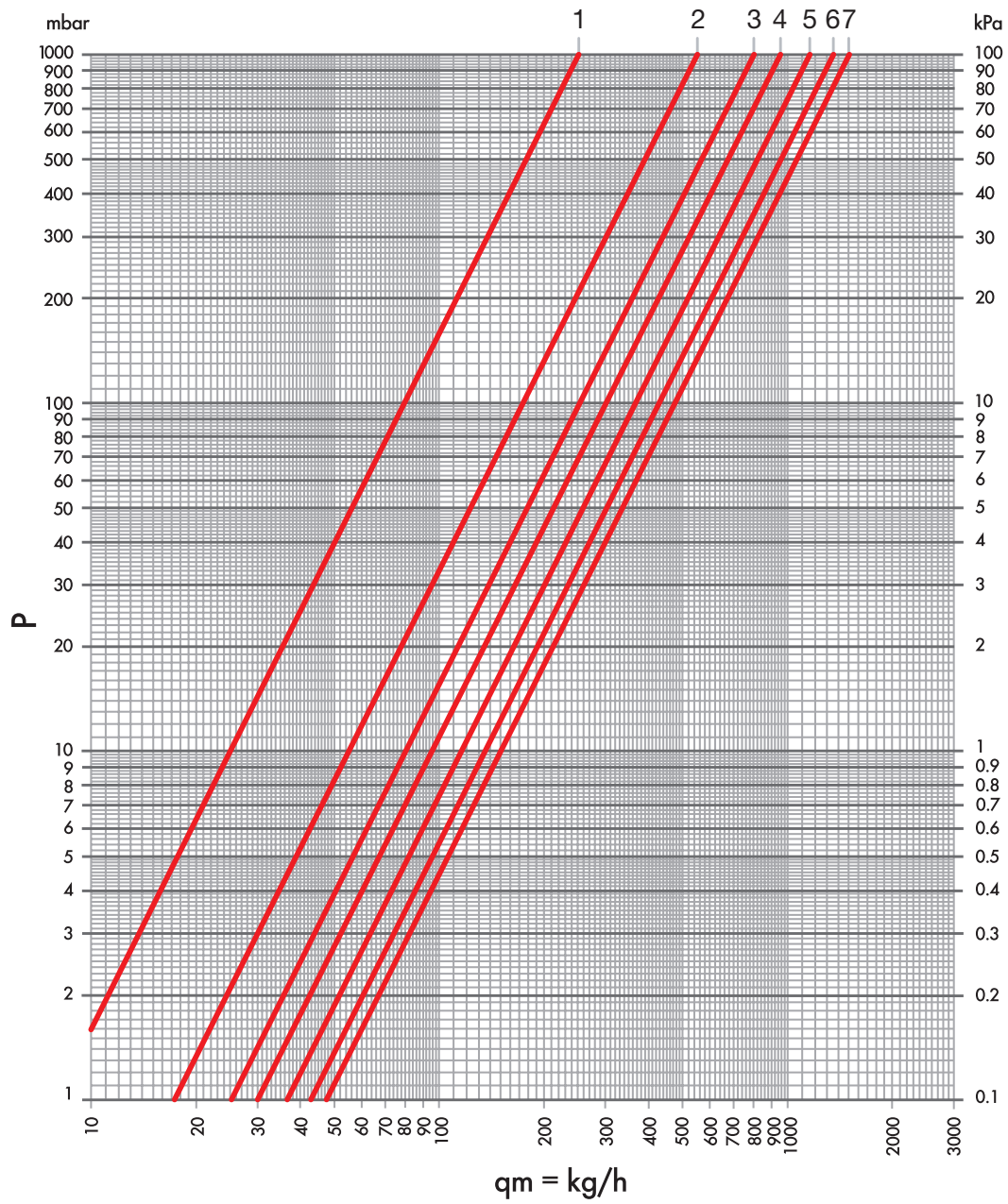

ITEM	TURNS N°	Kv	POS
MD 331/A MS 331/A	1	0,25	1
	1+1/2	0,55	2
	2	0,80	3
	2+1/2	0,95	4
	3	1,15	5
	3+1/2	1,35	6
	all open	1,50	7

VALVES FLOW RATE CHART

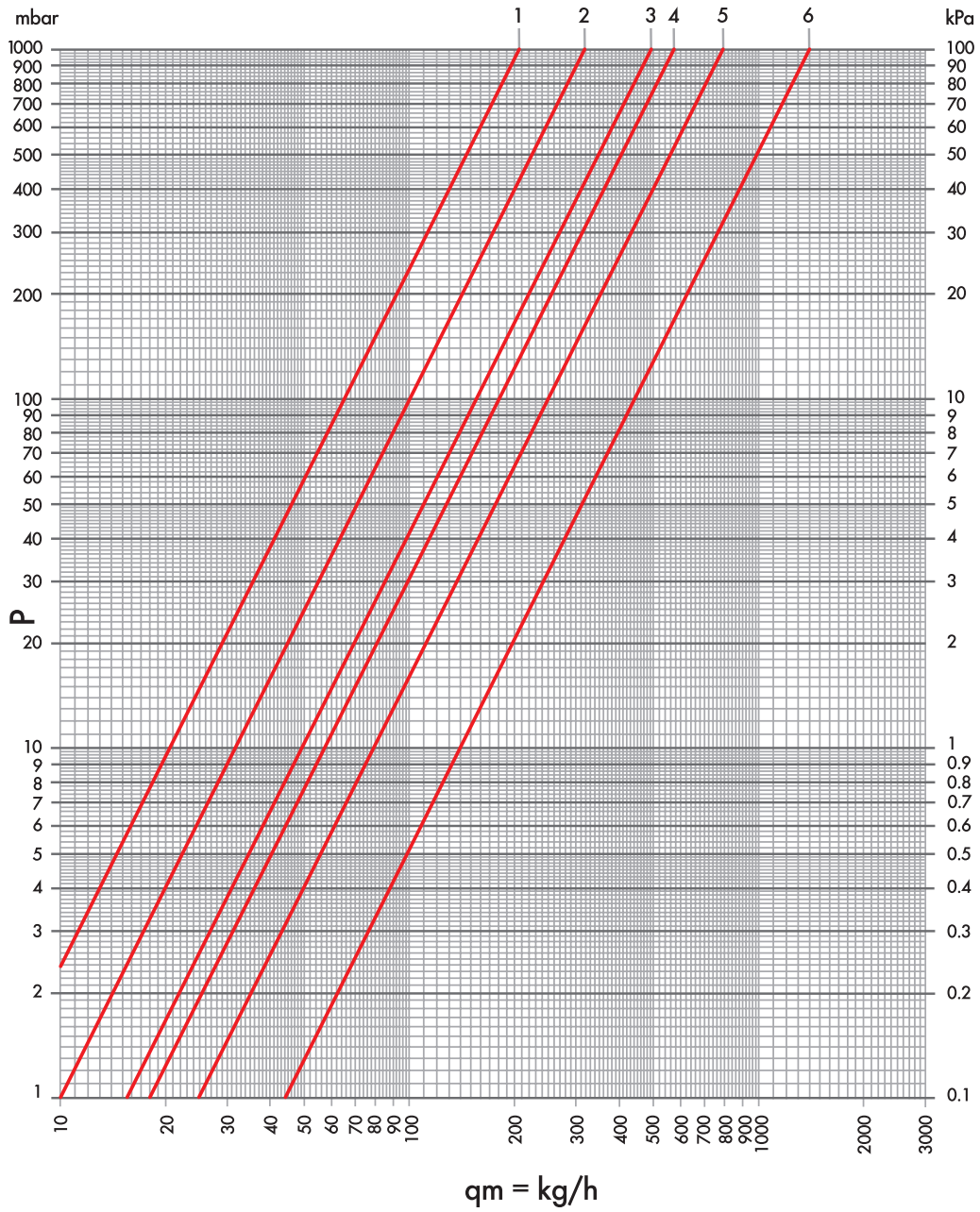

ITEM	Kv	Kv Δt 1 °C	Kv Δt 2 °C	POS
	0.21	0.15	0.19	1
M 320 M 320/A	0.32	0.20	0.25	2
M 330 M 330/A	0.49	0.24	0.36	3
M 322 M 332	0.57	0.24	0.37	4
MD 321/A MS 331/A	0.79	0.24	0.40	5
	1.39	0.32	0.55	6

M

4-WAY DISTRIBUTORS FOR SINGLE/DOUBLE PIPE DISTRIBUTION SYSTEM



The tightness of distributors towards the outside is ensured by an o-ring and a flat gasket inside the plug. When in closed position, the tightness is granted by an o-ring. The

distributors are nickel plated. All distributors allow for flow adjustment by limiting the lift of the obturator.

TECHNICAL DATA



DN

15



Max temperature

120 °C



Max pressure

10 bar



Max differential pressure

1 bar



Materials

CW617N
UNI EN
12165:2016



Knob

white ABS
RAL 9016

SYSTEM CONNECTIONS

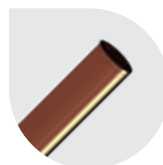

Copper pipe

W 24x19 - TR 91



Plastic pipe

W 24x19 - TP 95



Multilayer pipe

W 24x19 - TP 97

RADIATOR CONNECTION



conical knurled thread
G 1/2

CENTRE TO CENTRE DISTANCE

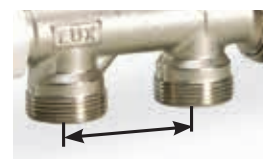

40 mm

INSTALLATION WITH REVERSE VALVE BODY

M distributors must be installed observing scrupulously the flow direction indicated by the arrow on the body.

4-way distributors can have the connection to the system from floor or wall.

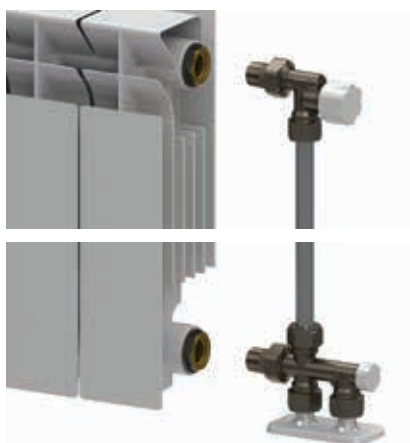

The characteristics of the fluid in the system must be compliant with the UNI 8065: 2019 directive.

**4-WAY DISTRIBUTORS FOR SINGLE/DOUBLE PIPE DISTRIBUTION SYSTEM:
CONNECTION FOR COPPER AND PLASTIC PIPE W24X19**

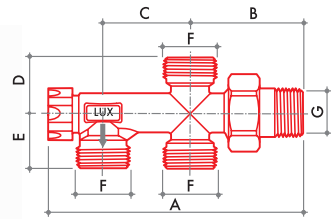

M 341

4-way distributor with floor connections. Maximum flow to radiator: 50% ring flow. Connections for copper and plastic pipe.

Fittings



CODE	SIZE	A	B	C	D	E	F	G	H	L			
13142100	DN 15 1/2	118	52	40	25	25	W24x19	R 1/2	-	-	243	10	80

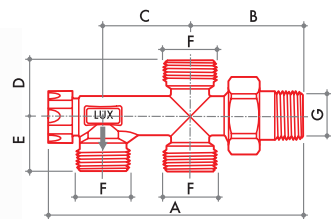

M 351

4-way distributor with floor connections. Maximum flow to radiator: 100% ring flow. Connections for copper and plastic pipe.

Fittings



CODE	SIZE	A	B	C	D	E	F	G	H	L			
13152100	DN 15 1/2	118	52	40	25	25	W24x19	R 1/2	-	-	244	10	80

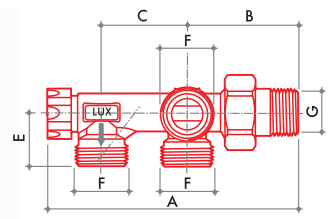

M 361

4-way distributor with wall connections. Maximum flow to radiator: 50% ring flow. Connections for copper and plastic pipe.

Fittings



CODE	SIZE	A	B	C	D	E	F	G	H	L			
13242100	DN 15 1/2	118	52	40	-	25	W24x19	R 1/2	-	-	308	6	48

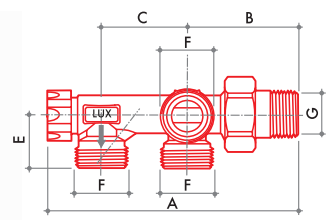

M 371

4-way distributor with wall connections. Maximum flow to radiator: 100% ring flow. Connections for copper and plastic pipe.

Fittings



CODE	SIZE	A	B	C	D	E	F	G	H	L			
13252100	DN 15 1/2	118	52	40	-	25	W24x19	R 1/2	-	-	309	6	48

**4-WAY DISTRIBUTORS FOR SINGLE/DOUBLE PIPE DISTRIBUTION SYSTEM:
CONNECTION FOR COPPER AND PLASTIC PIPE G3/4 EUROKONUS**

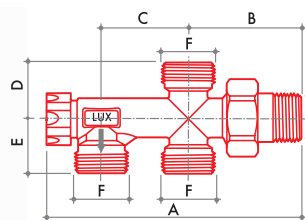

M 341/A

4-way distributor with floor connections. Maximum flow to radiator: 50% ring flow. Eurokonus connection.

Fittings



CODE	SIZE	A	B	C	D	E	F	G	H	L			
13142721	DN 15 1/2	118	52	40	25	25	G 3/4 EK	R 1/2	-	-	245	10	80

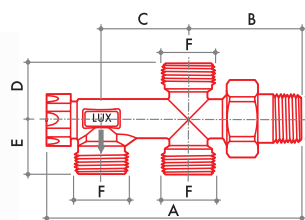

M 351/A

4-way distributor with floor connections. Maximum flow to radiator: 100% ring flow. Eurokonus connection.

Fittings



CODE	SIZE	A	B	C	D	E	F	G	H	L			
13152721	DN 15 1/2	118	52	40	25	25	G 3/4 EK	R 1/2	-	-	256	10	80

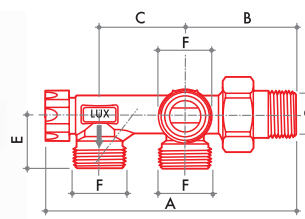

M 361/A

4-way distributor with wall connections. Maximum flow to radiator: 50% ring flow. Eurokonus connection.

Fittings

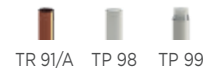

CODE	SIZE	A	B	C	D	E	F	G	H	L			
13242721	DN 15 1/2	118	52	40	-	25	G 3/4 EK	R 1/2	-	-	310	6	48

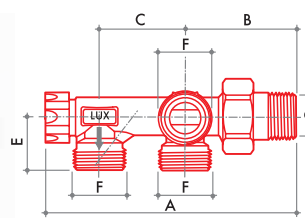

M 371/A

4-way distributor with wall connections. Maximum flow to radiator: 100% ring flow. Eurokonus connection.

Fittings



CODE	SIZE	A	B	C	D	E	F	G	H	L			
13252721	DN 15 1/2	118	52	40	-	25	G 3/4 EK	R 1/2	-	-	320	6	48



Fittings for copper pipe



Fittings for plastic pipe



Fittings for multilayer pipe



Fittings: chapter 7



Accessories: chapter 1.A

DISTRIBUTORS FLOW RATE CHART

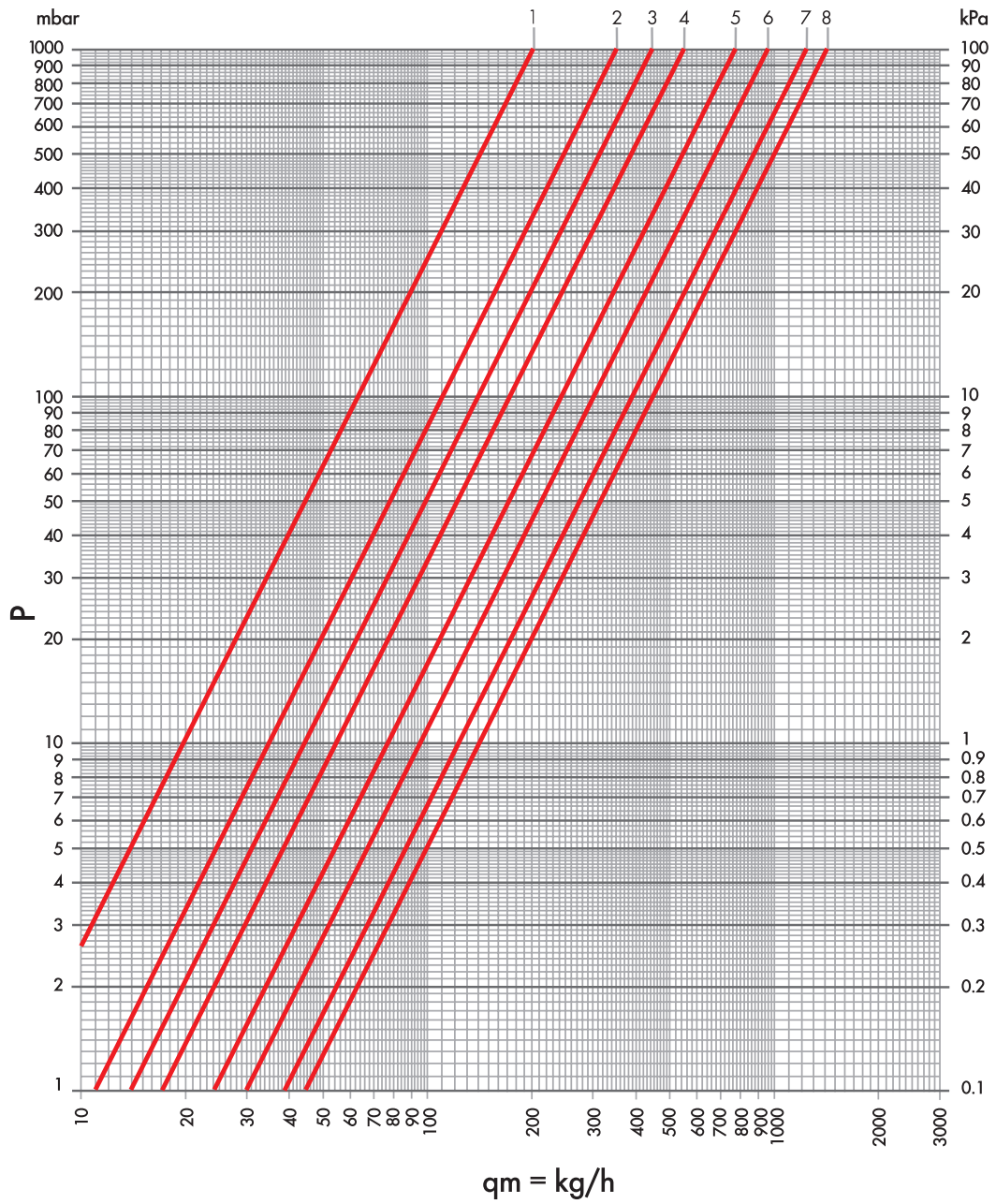

ITEM	TURNS N°	Kv	POS
M 351 M 351/A M 371 M 371/A	1	0.20	1
	1+1/2	0.35	2
	2	0.43	3
	2+1/2	0.55	4
	3	0.78	5
	3+1/2	0.95	6
	4	1.22	7
	all open	1.41	8

DISTRIBUTORS FLOW RATE CHART

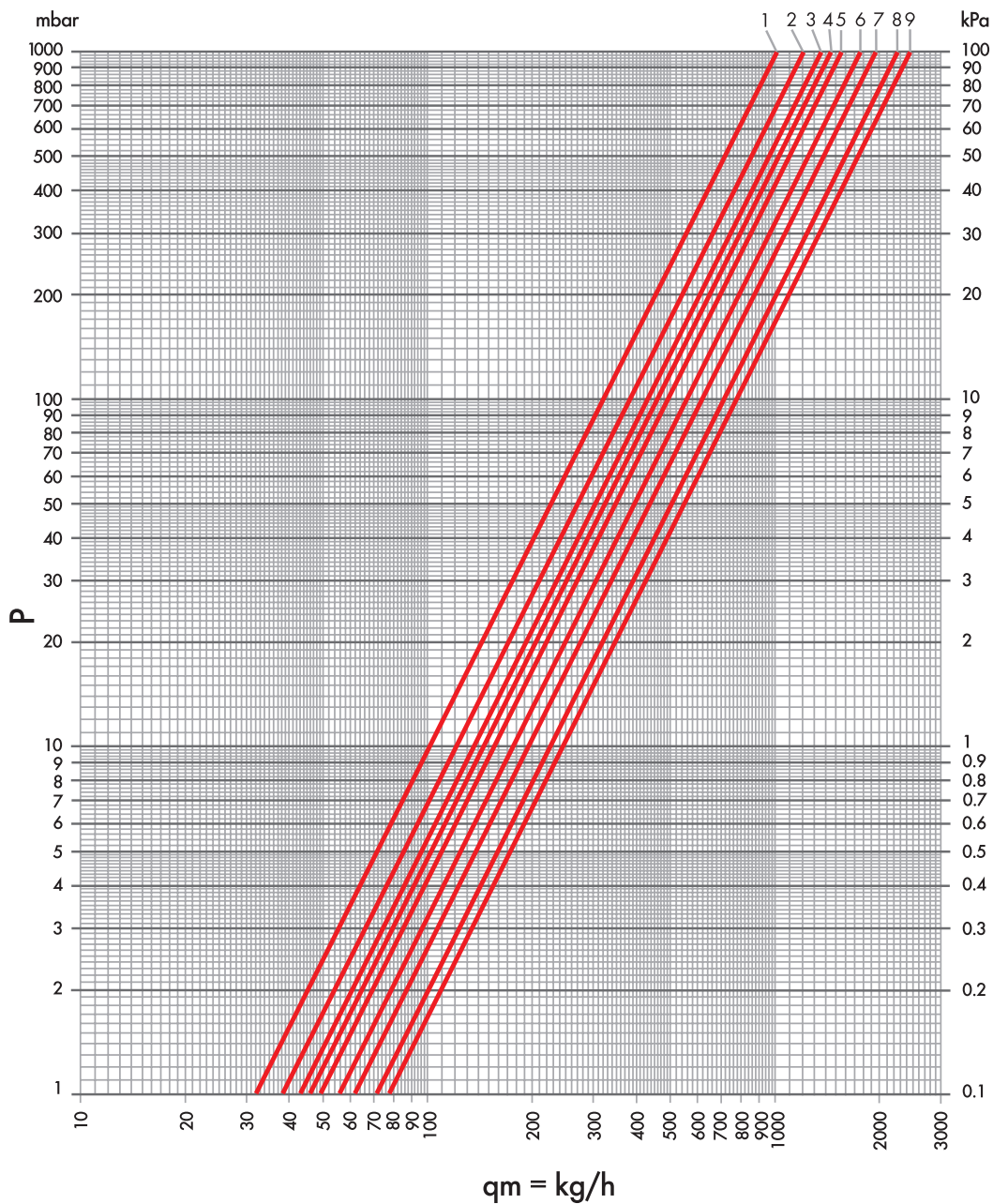

ITEM	TURNS N°	Kv	POS
M 341 M 341/A M 361 M 361/A	closed	1.00	1
	1	1.20	2
	1+1/2	1.35	3
	2	1.43	4
	2+1/2	1.55	5
	3	1.78	6
	3+1/2	1.95	7
	4	2.22	8
	all open	2.41	9

M COAXIAL VALVES



The coaxial valves have a headwork hat allows pre-regulation thanks to a shaped acetal ring. The thermostatic head allows the replacement of one of the sealing o-rings on the control rod without having to empty the system. The valves are produced with a nickel-plated finish.

The seal of the lockshield is ensured by an o-ring on the shutter and, if necessary, by a second o-ring between the body and the cap.

The seal in closing with the shutter is ensured by an o-ring and a metal conical seal. The lockshield are made with a nickel-plated finish. All lockshield can adjust the flow rate by limiting the shutter lift.

TECHNICAL DATA



DN

15



Max temperature

120 °C



Max pressure

10 bar



Max differential pressure (thermostatic valves)

0,6 bar



Max differential pressure

1 bar



Materials

CW617N
UNI EN
12165:2016



Knob

white ABS
RAL 9016



Stem

AISI 316

SYSTEM CONNECTIONS

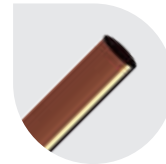

Copper pipe
G 3/4 EK - TR 91/A

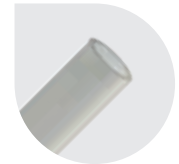

Plastic pipe
G 3/4 EK - TP 98



Multilayer pipe
G 3/4 EK - TP 99

RADIATOR CONNECTION



conical knurled thread
G 1/2

HOW TO SELECT THE CORRECT COAXIAL VALVES

COAXIAL RIGHT THERMOSTATIC KIT

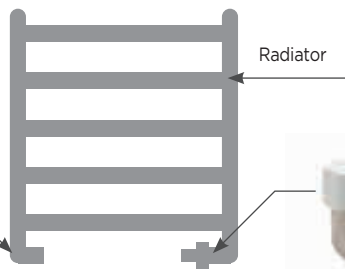

Thermostatic valve or right manual

COAXIAL LEFT THERMOSTATIC KIT

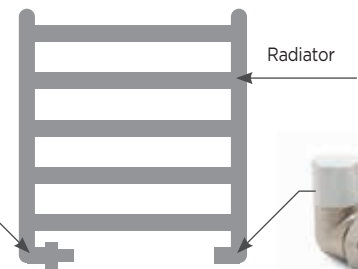

Right lockshield

The characteristics of the fluid in the system must be compliant with the UNI 8065: 2019 directive.

COAXIAL VALVES: CONNECTION FOR COPPER AND PLASTIC PIPE G3/4 EUROKONUS

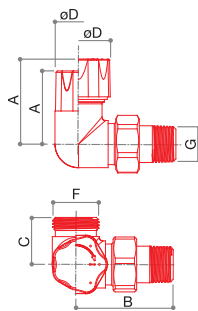

MD 321/A

Coaxial right radiator valve, thermostatically or electronically controlled with protection cap. Eurokonus connections.

Fittings



CODE	SIZE	A	B	C	D	E	F	G	H	L			
13272722	DN 15 1/2	49	56	27	37	-	G 3/4 EK	R 1/2	-	-	287	10	80

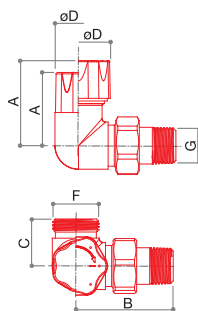

MS 331/A

Coaxial left regulating lockshield. Eurokonus connections.

Fittings



CODE	SIZE	A	B	C	D	E	F	G	H	L			
13252722	DN 15 1/2	42	56	27	30	-	G 3/4 EK	R 1/2	-	-	258	10	80

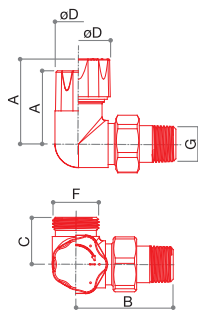

MS 321/A

Coaxial left radiator valve, thermostatically or electronically controlled with protection cap. Eurokonus connections.

Fittings



CODE	SIZE	A	B	C	D	E	F	G	H	L			
13292722	DN 15 1/2	49	56	27	37	-	G 3/4 EK	R 1/2	-	-	287	10	80

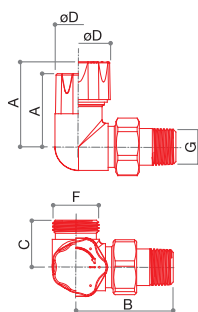

MD 331/A

Coaxial right regulating lockshield. Eurokonus connections.

Fittings



CODE	SIZE	A	B	C	D	E	F	G	H	L			
13232722	DN 15 1/2	42	56	27	30	-	G 3/4 EK	R 1/2	-	-	258	10	80



Fittings for copper pipe



Fittings for plastic pipe



Fittings for multilayer pipe



Fittings: chapter 7



Accessories: chapter 1.A

M

SINGLE/DOUBLE PIPE SYSTEM DISTRIBUTORS FOR HEATING BODY WITH BUILT-IN VALVE



The tightness of distributors is ensured by an o-ring and a flat gasket inside the plug. When in closed position, the tightness is granted by an o-ring and a conical metal collar.

The distributors are nickel plated. All distributors allow for flow adjustment by limiting the lift of the obturator.

TECHNICAL DATA



DN

15



Max temperature

120 °C



Max pressure

10 bar



Max differential pressure
1 bar



Materials

CW617N
UNI EN
12165:2016



Knob

white ABS
RAL 9016

SYSTEM CONNECTIONS

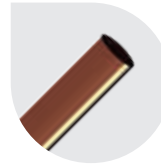

Copper pipe

W 24x19 - TR 91
G 3/4 EK - TR 91/A

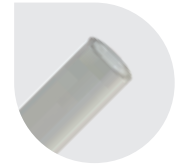

Plastic pipe

W 24x19 - TP 95
G 3/4 EK - TP 98



Multilayer pipe

W 24x19 - TP 97
G 3/4 EK - TP 99

CENTRE DISTANCE



50 mm

RADIATOR CONNECTION

M distributors are designed to be installed on heating bodies with G 3/4 eurokonus connections.

In case of G 1/2 F connections, it is possible to install a M 532 adaptor.



The characteristics of the fluid in the system must be compliant with the UNI 8065: 2019 directive.

SINGLE/DOUBLE PIPE SYSTEM DISTRIBUTORS FOR HEATING BODY WITH BUILT-IN VALVE: CONNECTION FOR COPPER AND PLASTIC PIPE W24X19

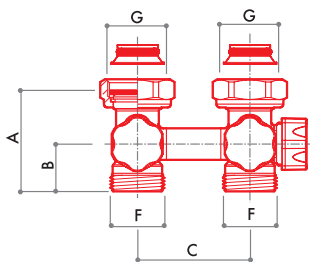

M 171

Single / double pipe distributor

- radiator connections 3/4 female swivel nut
- floor connections 24x19 for copper and plastic pipe.

Fittings



CODE	SIZE	A	B	C	D	E	F	G	H	L			
13462100	-	45	21	50	-	-	W24x19	G 3/4	-	-	315	6	48

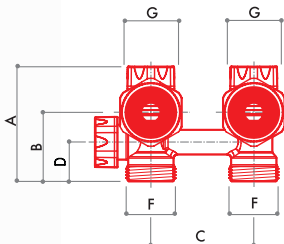

M 173

Single / double pipe distributor

- radiator connections 3/4 female swivel nut
- wall connection 24x19 for copper and plastic pipe.

Fittings



CODE	SIZE	A	B	C	D	E	F	G	H	L			
13462101	-	57	34	50	19	-	W24x19	G 3/4	-	-	310	6	48

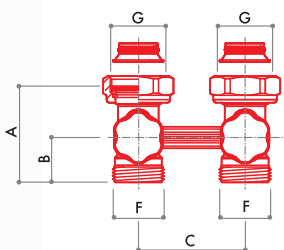

M 175

Double pipe distributor

- radiator connections 3/4 female swivel nut
- floor connections 24x19 for copper and plastic pipe.

Fittings



CODE	SIZE	A	B	C	D	E	F	G	H	L			
13472100	-	45	21	50	-	-	W24x19	G 3/4	-	-	245	6	48

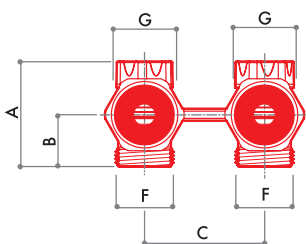

M 177

Double pipe distributor

- radiator connections 3/4 female swivel nut
- wall connections 24x19 for copper and plastic pipe.

Fittings



CODE	SIZE	A	B	C	D	E	F	G	H	L			
13472101	-	44	22	50	-	-	W24x19	G 3/4	-	-	255	6	48



Fittings for copper pipe



Fittings for plastic pipe



Fittings for multilayer pipe



Fittings: chapter 7



Accessories: chapter 1.A

**SINGLE/DOUBLE PIPE SYSTEM DISTRIBUTORS FOR HEATING BODY WITH BUILT-IN VALVE:
CONNECTION FOR COPPER AND PLASTIC PIPE G3/4 EUROKONUS**

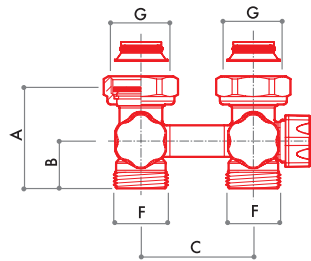

M 172

Single / double pipe distributor

- radiator connections 3/4 female swivel nut
- floor connections eurokonus type for copper and plastic pipe.

Fittings



CODE	SIZE	A	B	C	D	E	F	G	H	L			
13462700	-	45	21	50	-	-	G 3/4 EK	G 3/4	-	-	325	6	48

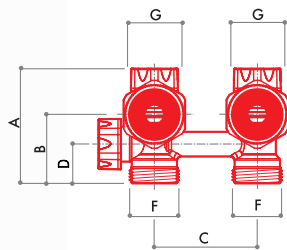

M 174

Single / double pipe distributor

- radiator connections 3/4 female swivel nut
- wall connections eurokonus type for copper and plastic pipe.

Fittings



CODE	SIZE	A	B	C	D	E	F	G	H	L			
13462701	-	57	34	50	19	-	G 3/4 EK	G 3/4	-	-	320	6	48

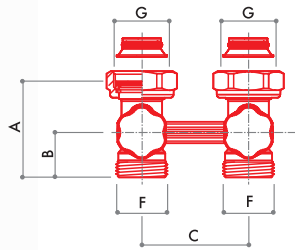

M 176

Double pipe distributor

- radiator connections 3/4 female swivel nut
- floor connections eurokonus type for copper and plastic pipe.

Fittings



CODE	SIZE	A	B	C	D	E	F	G	H	L			
13472700	-	45	21	50	-	-	G 3/4 EK	G 3/4	-	-	255	6	48

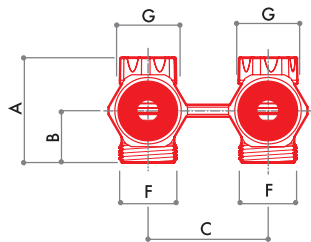

M 178

Double pipe distributor

- radiator connections 3/4 female swivel nut
- wall connections eurokonus type for copper and plastic pipe.

Fittings



CODE	SIZE	A	B	C	D	E	F	G	H	L			
13472701	-	44	22	50	-	-	G 3/4 EK	G 3/4	-	-	260	6	48

DISTRIBUTORS FLOW RATE CHART

BYPASS ADJUSTMENT FLOW CHART

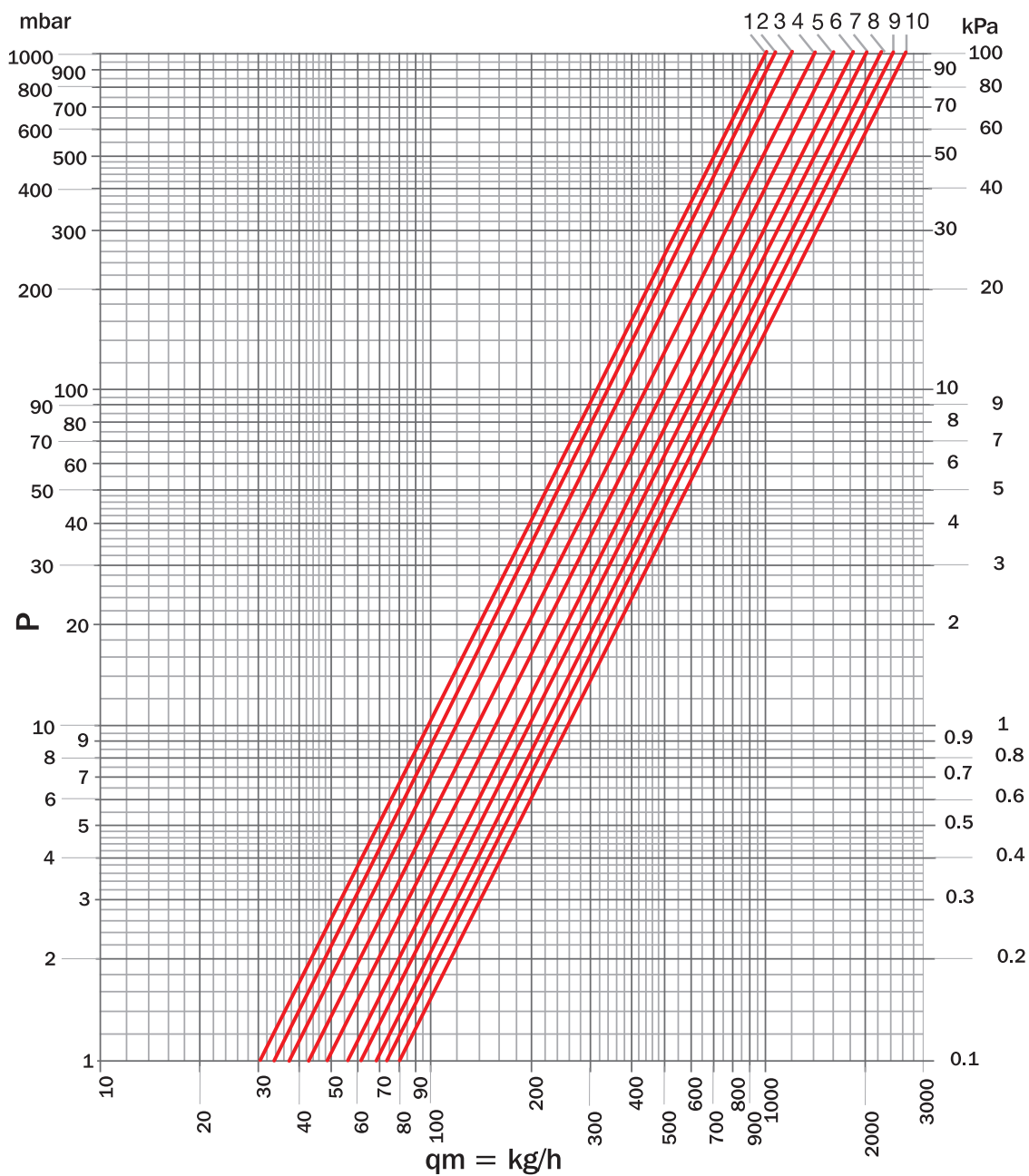

ITEM	TURNS N°	Kv bypass	Kvs	POS
M 171 M 172 M 173 M 174	0	0	1,00	1
	1/4	0,13	1,13	2
	1/2	0,22	1,22	3
	3/4	0,43	1,43	4
	1	0,65	1,65	5
	1+1/4	0,80	1,80	6
	1+1/2	0,97	1,97	7
	2	1,20	2,20	8
	2+1/2	1,38	2,38	9
	3	1,60	2,60	10

DISTRIBUTORS FLOW RATE CHART

ADJUSTMENT FLOW CHART

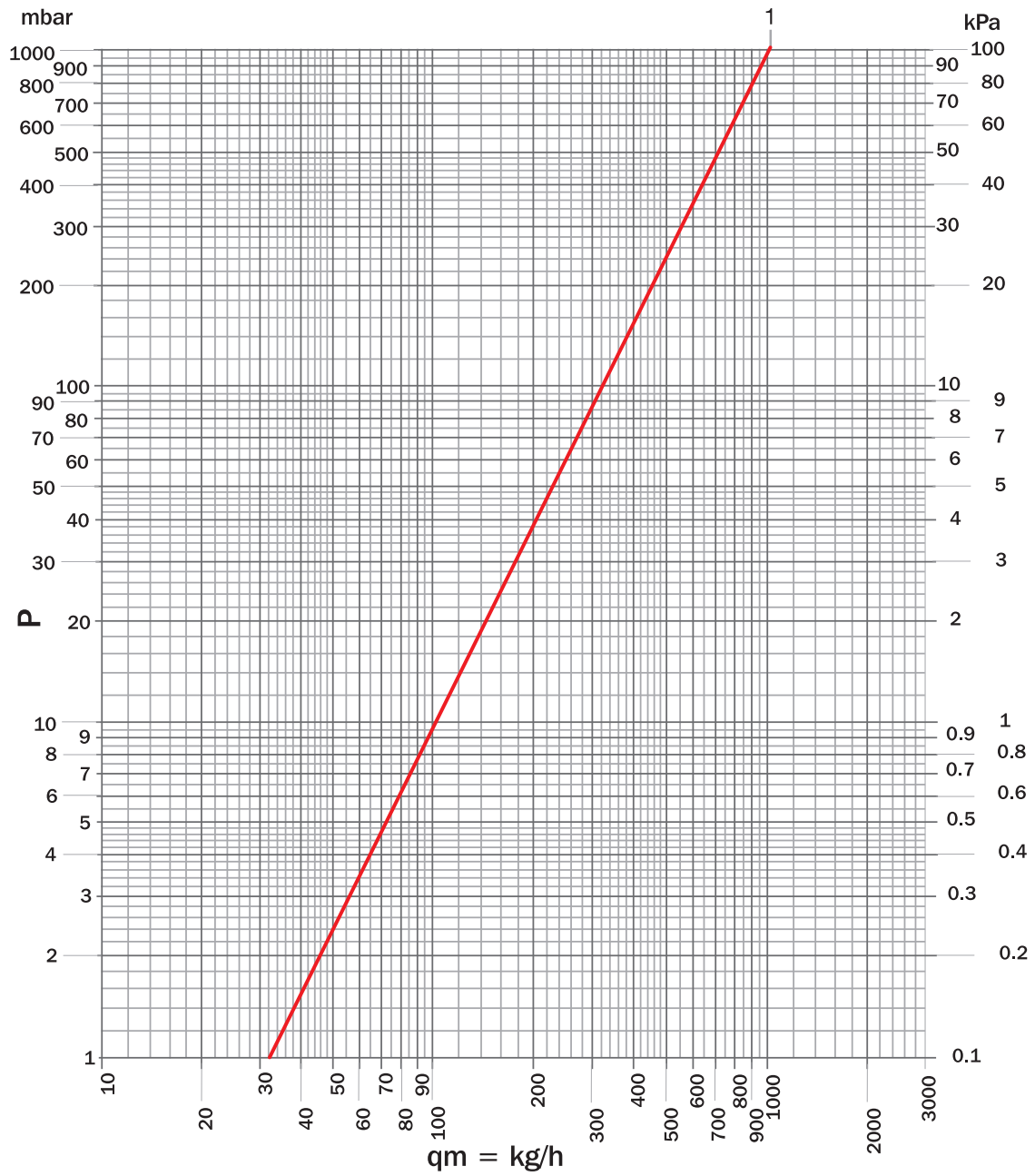

ITEM	RA %	TURNS N°	Kvs	POS
M 175 M 176 M 177 M 178	100%	all open	1	1



LUXOR®

RADIATOR VALVES



1.A / ACCESSORIES

ACCESSORIES FOR VALVES, LOCKSHIELDS, 4-WAY VALVES AND DISTRIBUTORS LUXOR



507



Brass nut for fittings with spherical seat, for valves, lockshields and M valves (1/2 for 90° elbow fittings of straight M valves).

CODE	SIZE			
1946672	G 5/8 - DN 10 3/8	28	-	-
1946676LN	G 3/4 - DN 15 1/2	25	-	-
1946682	G 1" - DN 20 3/4	45	-	-



508

Brass fitting with spherical seat and o-ring, conical gas thread for valves and lockshields.

CODE	SIZE			
67891700	DN 10 3/8	24	50	400
67892100	DN 15 1/2	37	50	400
67892700	DN 20 3/4	64	30	240



508/B



Brass special fitting with spherical seat and double o-ring for valves and lockshields.

CODE	SIZE			
67001700	DN 3/8	39	40	320



509



EPDM o-ring washer for fittings with spherical seat.

CODE	SIZE			
3424650	DN 10 3/8	-	-	-
3424662	DN 15 1/2	-	-	-
3424693	DN 20 3/4	-	-	-



CR 498



Nickel plated brass nut and fitting with o-ring to connect regulating valves and lockshields.

CODE	SIZE			
67901700	DN 10 3/8	60	50	400
67902100	DN 15 1/2	72	50	400
67902700	DN 20 3/4	120	20	160



517



PP (polypropylene) universal wall cover with snap opening, white coloured.

CODE	SIZE			
67790220	8÷22 mm	6	25	500



518

PP (polypropylene) wall cover with snap opening, white coloured.



CODE	SIZE			
67790217	G 3/8-18 mm	6	25	500
67790221	G 1/2	6	25	500
67790227	G 3/4	6	25	500
67790210	10 mm	6	25	500
67790212	12 mm	6	25	500
67790214	14 mm	6	25	500
67790216	16 mm	6	25	500



M 529

Interlocking ABS wall cover, white coloured.

ARTICLE DISCONTINUED.

CODE	SIZE			
67790265	Ø15÷16 mm	8	200	1200



M 530

Double interlocking ABS wall cover, white coloured (RAL 9016).



ARTICLE DISCONTINUED.

CODE	SIZE	INTERAXIS			
67790238	Ø15÷16 mm	38 mm	17	50	300



M 531

Universal double interlocking ABS wall cover, white coloured (RAL 9016).

CODE	SIZE	INTERAXIS			
67790240	Ø10÷16 mm	40 mm	12	100	600

ACCESSORIES FOR EASY AND SMART SERIES



574

ABS manual adjustment knob for valve series Easy, white coloured (RAL 9016).

CODE	SIZE			
4761915	-	12	-	-



505

Flat fasit 205 washer for plug article 578.

CODE	SIZE			
3405850	-	1	-	-



578

ABS plug for lockshield series Easy, white coloured (RAL 9016).

CODE	SIZE			
8761935	W19x19	2	-	-

ACCESSORIES FOR TEKNA SERIES



580

Brass screw for manual adjustment knob for Tekna valves.

CODE	SIZE			
9346615	-	1	-	-



576

ABS plug for Tekna lockshields, white coloured (RAL 9016).

CODE	SIZE			
8761923	M23x19	6	-	-

ACCESSORIES FOR THERMOTEKNA SERIES



VT 2600

Manual adjustment knob for ThermoTekna valves. Knob and fastening ring nut in white ABS (RAL 9016).

CODE	SIZE			
69010104	M30x1.5	16	30	240



TM 245

ABS protection cap for ThermoTekna valves, white coloured (RAL 9016).

CODE	SIZE			
8761904	M30x1.5	8	50	400



515

Thermostatic screw with pre-regulation for ThermoTekna valves.

CODE	SIZE			
67980006	-	24	-	-



CH 112

Key for the flow rate adjustment while the system is working.

CODE	SIZE			
67822717	-	10	100	-



CH 111

Key for screw replacement with the system operating, for ThermoTekna valves.

CODE	SIZE			
67822720	-	2097	1	-









583

EPDM o-ring for thermostatic screw series ThermoTekna.

CODE	SIZE			
3424704	-	-	-	-



ACCESSORIES FOR 50th SERIES**GS 1995**

Single in-wall 90° elbow fitting, blue or red coloured, without bracket, with brass plug and o-ring.

CODE	SIZE						
66004100B	G 1/2 x (W24x19)	TR 91	TP 95	TP 97	122	8	64
66004100R	G 1/2 x (W24x19)	TR 91	TP 95	TP 97	122	8	64
66004102B	G 1/2 x G 3/4 EK	TR 91/A	TP 98	TP 99	127	8	64
66004102R	G 1/2 x G 3/4 EK	TR 91/A	TP 98	TP 99	127	8	64

**M 528**

Chrome-plated copper connection pipe with soft sealing for distribution boxes.

CODE	SIZE			
67510015	G 1/2 x (Ø 15 x 140)	72	35	280
67520015	G 1/2 x (Ø 15 x 175)	86	30	240

**535**

Universal interlocking ABS wall cover, chrome plated.

CODE	SIZE			
67790224C	10 ÷ 22 mm	6	100	-

**536**

Universal interlocking ABS wall cover, chrome plated, full covering.

CODE	SIZE			
67790225C	10 ÷ 18 mm	18	25	-

**KT 502**

Pipe cover kit ø 12-14-16mm.
Chrome-plated wall cover and tube.

CODE	SIZE			
67790200CCA	Wall cover size: ø 55 mm Pipe size: L 70 mm	92	1	30

ACCESSORIES FOR M-MT SERIES

**M 525**

PA 6 (polyamide) extension for probe for 4-way single pipe valves.

CODE	SIZE			
67790230	400 mm	16	50	500
67790299	1000 mm	40	-	-

**513**

Cylindrical washer PTFE for piston rod of valves series M 87 and M 88.

CODE	SIZE			
3489805	-	1	-	-

**584**

Brass radiator connection for 4-way single pipe valves M 85 and M 86.

CODE	SIZE			
0746810M	-	155	25	200

**M 520**

Brass nut for radiator connection of 4-ways valves.

CODE	SIZE			
1946803	-	52	-	-

**586**

PA 6 probe with flow diverter for single pipe valves M 85 and M 86.

CODE	SIZE			
7761810	-	4	-	-

**M 521**

Brass radiator connection for 4-way single pipe valves.

CODE	SIZE			
7146803	DN 15 1/2	41	-	-
7146805	DN 20 3/4	38	-	-

**500**

ABS manual adjustment knob for valves M 87 and M 88, white coloured (RAL 9016).

CODE	SIZE			
4761603	-	11	-	-

**M 522**

PA 6 (polyamide) counterprobe with flow diverter for M 4-way single pipe valves.

CODE	SIZE			
7761811	-	3	-	-

**512**

Brass stuffing nut for stem PTFE cylindrical gasket, valves M 87 and M 88.

CODE	SIZE			
1946602	-	7	-	-

**M 523**

PA 6 (polyamide) probe with flow diverter for 4-way single pipe valves.

CODE	SIZE			
7761803	DN 15 1/2	7	-	-
7761805	DN 20 3/4	7	-	-

**M 524**

Fasit omnia flat washer for radiator connection for 4-way single pipe valves.

CODE	SIZE			
3405855	-	2	-	-



M 526

Chrome plated soft steel pipe to connect single pipe groups with double connection (reverse valves and straight valves with 90° fitting connected to distributors M 340, M 340/A, M 350, M 350/A, M 360, M 360/A, M 370 and M 370/A).

CODE	SIZE	LENGHT			
67500115	Ø 15 mm	500 mm	172	-	-
67500215	Ø 15 mm	600 mm	208	-	-
67500315	Ø 15 mm	800 mm	278	-	-
67500015	Ø 15 mm	1000 mm	348	-	-



M 532

Brass adapter with o-ring for single / double pipe distributors.

CODE	SIZE			
69190000	3/4 M x 1/2 M	30	100	800



M 533

Brass eurokonus adapter with o-ring for single / double pipe distributors.

CODE	SIZE			
69190200	-	10	100	800



LUXOR®

SIMPLE MANIFOLDS

2.1 / CP SERIES

CP SIMPLE MODULAR MANIFOLDS



*In compliance with
D.M. 174/2004

CP manifolds are machined after the nickel plating phase, so as to comply with Italian regulation D.M. 174/2004 about the transport of drinking water.

All manifolds undergo a post weld heat treatment to eliminate any tension caused from processing.

TECHNICAL DATA



Max temperature

120 °C



Max pressure

10 bar



Materials

CW617N
UNI EN
12165:2016

SYSTEM CONNECTIONS

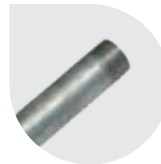

Iron pipe
G 1/2

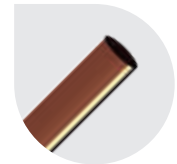

Copper pipe
W 24x19 - TR 91
G 3/4 EK - TR 91/A
G 1/2 - TR 890



Plastic pipe
W 24x19 - TP 95
G 3/4 EK - TP 98
G 1/2 - TP 93



Multilayer pipe
W 24x19 - TP 97
G 3/4 EK - TP 99
G 1/2 - TP 96

**MAIN
BODY
CONNECTION**

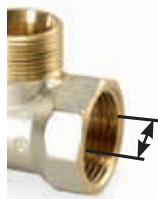

G 3/4
G 1"

**CENTRE TO
CENTRE
DISTANCE**

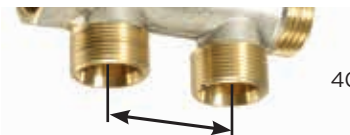

40 mm

The characteristics of the fluid in the system must be compliant with the UNI 8065: 2019 directive.

**SIMPLE MODULAR MANIFOLDS:
CONNECTION FOR COPPER AND PLASTIC PIPE W24X19**

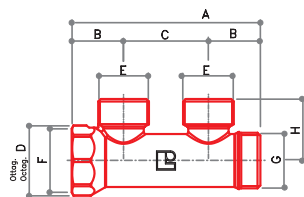

CP 402

Manifolds with two lateral male connections (W24x19). In compliance with D.M. 174/2004.



Fittings



CODE	SIZE	A	B	C	D	E	F	G	H	L			
68522700	G 3/4 x (W24x19)	89	24,5	40	31	W24x19	G 3/4	G 3/4	29	-	180	15	120
68523400	G 1" x (W24x19)	89	24,5	40	38	W24x19	G 1"	G 1"	32,5	-	210	12	96

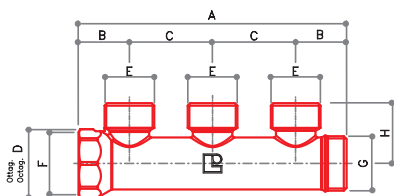

CP 403

Manifolds with three lateral male connections (W24x19). In compliance with D.M. 174/2004.



Fittings



CODE	SIZE	A	B	C	D	E	F	G	H	L			
68532700	G 3/4 x (W24x19)	129	24,5	40	31	W24x19	G 3/4	G 3/4	29	-	240	12	96
68533400	G 1" x (W24x19)	129	24,5	40	38	W24x19	G 1"	G 1"	32,5	-	290	8	64

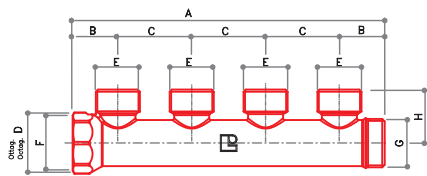

CP 404

Manifolds with four lateral male connections (W24x19). In compliance with D.M. 174/2004.



Fittings



CODE	SIZE	A	B	C	D	E	F	G	H	L			
68542700	G 3/4 x (W24x19)	169	24,5	40	31	W24x19	G 3/4	G 3/4	29	-	303	10	80
68543400	G 1" x (W24x19)	169	24,5	40	38	W24x19	G 1"	G 1"	32,5	-	374	6	48

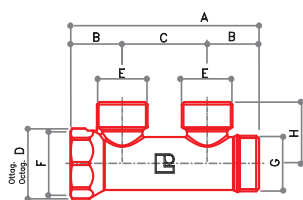

SIMPLE MODULAR MANIFOLDS: CONNECTION FOR COPPER AND PLASTIC PIPE G3/4 EUROKONUS

**CP 412**

Manifolds with two lateral male connections 3/4 eurokonus. In compliance with D.M. 174/2004.

Fittings



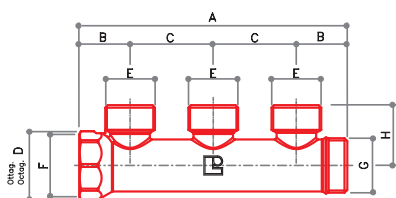

CODE	SIZE	A	B	C	D	E	F	G	H	L			
68522705	G 3/4 x G 3/4 EK	89	24,5	40	31	G 3/4 EK	G 3/4	G 3/4	29	-	170	15	120
68523405	G 1" x G 3/4 EK	89	24,5	40	38	G 3/4 EK	G 1"	G 1"	32,5	-	210	12	96

**CP 413**

Manifolds with three lateral male connections 3/4 eurokonus. In compliance with D.M. 174/2004.

Fittings



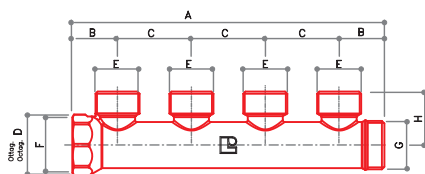

CODE	SIZE	A	B	C	D	E	F	G	H	L			
68532705	G 3/4 x G 3/4 EK	129	24,5	40	31	G 3/4 EK	G 3/4	G 3/4	29	-	230	12	96
68533405	G 1" x G 3/4 EK	129	24,5	40	38	G 3/4 EK	G 1"	G 1"	32,5	-	280	8	64

**CP 414**

Manifolds with four lateral male connections 3/4 eurokonus. In compliance with D.M. 174/2004.

Fittings



CODE	SIZE	A	B	C	D	E	F	G	H	L			
68542705	G 3/4 x G 3/4 EK	169	24,5	40	31	G 3/4 EK	G 3/4	G 3/4	29	-	303	10	80
68543405	G 1" x G 3/4 EK	169	24,5	40	38	G 3/4 EK	G 1"	G 1"	32,5	-	340	6	48

**SIMPLE MODULAR MANIFOLDS:
CONNECTION FOR COPPER AND PLASTIC PIPE G1/2**

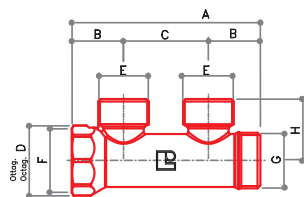

CP 422

Manifolds with two lateral male connections 1/2. In compliance with D.M. 174/2004.



Fittings

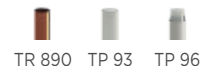

CODE	SIZE	A	B	C	D	E	F	G	H	L			
68522701	G 3/4 x G 1/2	89	24,5	40	31	G 1/2	G 3/4	G 3/4	29	-	164	15	120
68523401	G 1" x G 1/2	89	24,5	40	38	G 1/2	G 1"	G 1"	32,5	-	210	12	96

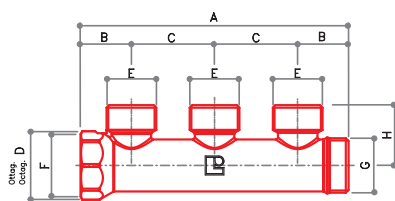

CP 423

Manifolds with three lateral male connections 1/2. In compliance with D.M. 174/2004.



Fittings



CODE	SIZE	A	B	C	D	E	F	G	H	L			
68532701	G 3/4 x G 1/2	129	24,5	40	31	G 1/2	G 3/4	G 3/4	29	-	225	12	96
68533401	G 1" x G 1/2	129	24,5	40	38	G 1/2	G 1"	G 1"	32,5	-	275	8	64

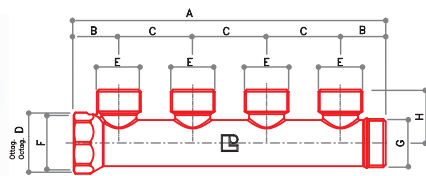

CP 424

Manifolds with four lateral male connections 1/2. In compliance with D.M. 174/2004.



Fittings



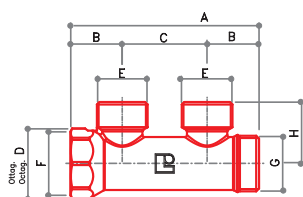

CODE	SIZE	A	B	C	D	E	F	G	H	L			
68542701	G 3/4 x G 1/2	169	24,5	40	31	G 1/2	G 3/4	G 3/4	29	-	300	10	80
68543401	G 1" x G 1/2	169	24,5	40	38	G 1/2	G 1"	G 1"	32,5	-	350	6	48

SIMPLE MODULAR MANIFOLDS: CONNECTION FOR IRON PIPE G1/2

**CP 442**

Manifolds with two lateral female connections 1/2.
In compliance with D.M. 174/2004.



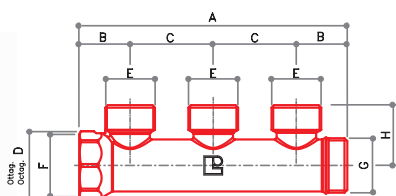

CODE	SIZE	A	B	C	D	E	F	G	H	L			
68522702	G 3/4 x G 1/2	89	24,5	40	31	G 1/2	G 3/4	G 3/4	29	-	170	15	120
68523402	G 1" x G 1/2	89	24,5	40	38	G 1/2	G 1"	G 1"	32,5	-	235	12	96

**CP 443**

Manifolds with three lateral female connections 1/2.
In compliance with D.M. 174/2004.



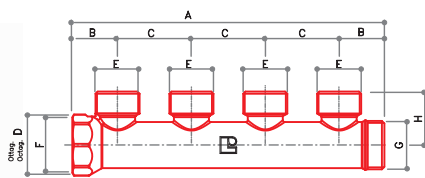

CODE	SIZE	A	B	C	D	E	F	G	H	L			
68532702	G 3/4 x G 1/2	129	24,5	40	31	G 1/2	G 3/4	G 3/4	29	-	230	12	96
68533402	G 1" x G 1/2	129	24,5	40	38	G 1/2	G 1"	G 1"	32,5	-	300	8	64

**CP 444**

Manifolds with four lateral female connections 1/2.
In compliance with D.M. 174/2004.



CODE	SIZE	A	B	C	D	E	F	G	H	L			
68542702	G 3/4 x G 1/2	169	24,5	40	31	G 1/2	G 3/4	G 3/4	29	-	303	10	80
68543402	G 1" x G 1/2	169	24,5	40	38	G 1/2	G 1"	G 1"	32,5	-	420	6	48

MANIFOLDS FLOW RATE CHART

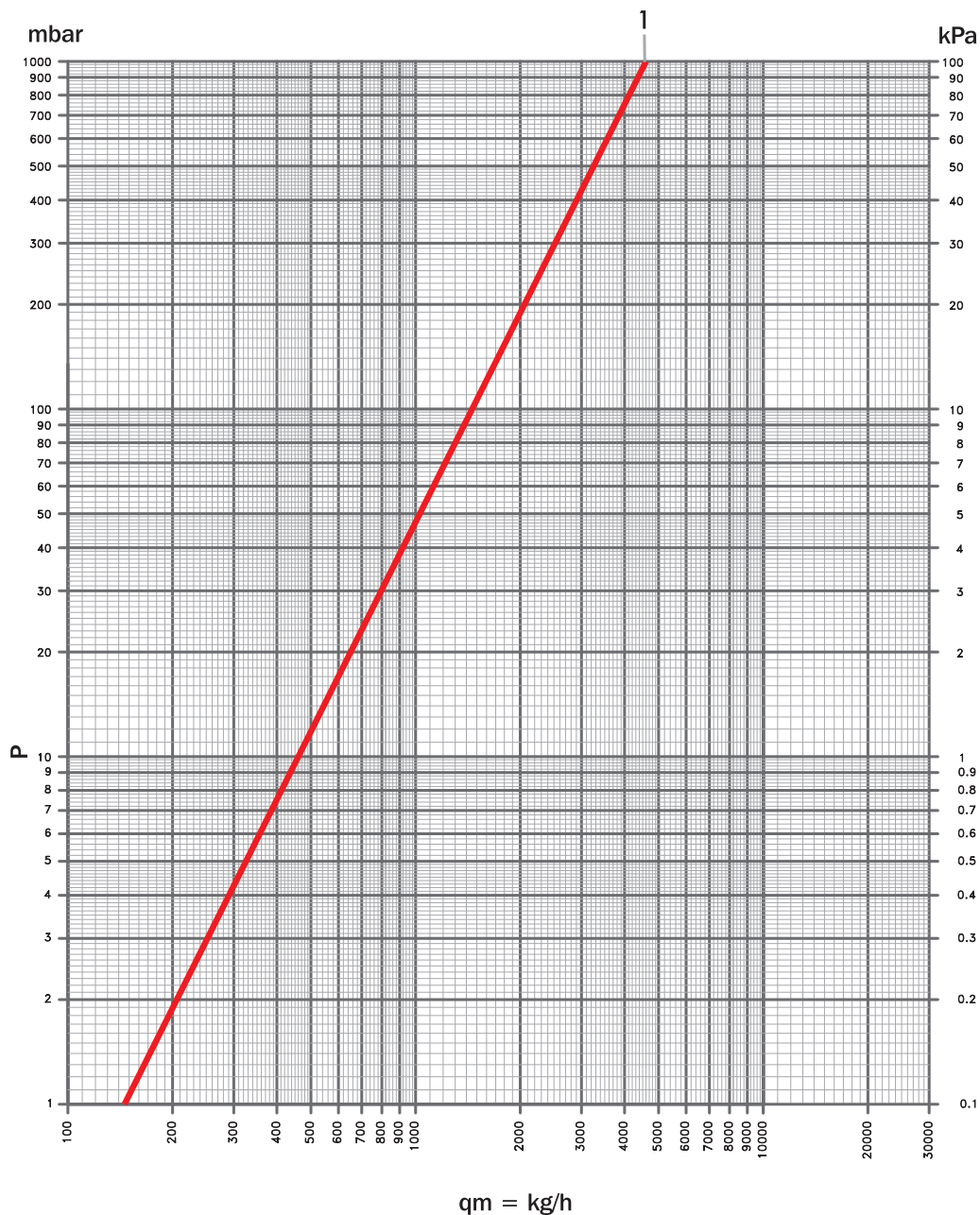

ITEM	SIZE	Kvs	POS
CP 402	G 3/4	4,6	1
CP 403			
CP 404			
CP 412			
CP 413			
CP 414			
CP 422	G 1"	4,6	1
CP 423			
CP 424			
CP 442			
CP 443			
CP 444			

CP

SIMPLE MODULAR MANIFOLDS WITH SHUT-OFF VALVES







*In compliance with D.M. 174/2004

CP manifolds feature a fixed stem whose tightness is ensured by two o-rings, and by a flat gasket when in closed position. All manifolds are supplied with labels indicating the various utilities.

CP manifolds are machined after the nickel plating phase, so as to comply with Italian regulation D.M. 174/2004 about the transport of drinking water. **All manifolds undergo a post weld heat treatment to eliminate any tension caused from processing.**

SYSTEM CONNECTIONS

	
Max temperature	Max pressure
120 °C	10 bar
	
Materials	Knob
CW617N UNI EN 12165:2016	white ABS RAL 9016

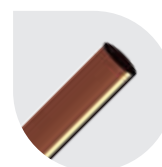

Copper pipe
W 24x19 - TR 91
G 3/4 EK - TR 91/A
G 1/2 - TR 890



Plastic pipe
W 24x19 - TP 95
G 3/4 EK - TP 98
G 1/2 - TP 93



Multilayer pipe
W 24x19 - TP 97
G 3/4 EK - TP 99
G 1/2 - TP 96

MAIN BODY CONNECTION



G 3/4
G 1"

CENTRE TO CENTRE DISTANCE



40 mm



The outlets are 4mm offset to facilitate the installation of the fittings inside the cabinet.

The characteristics of the fluid in the system must be compliant with the UNI 8065: 2019 directive.

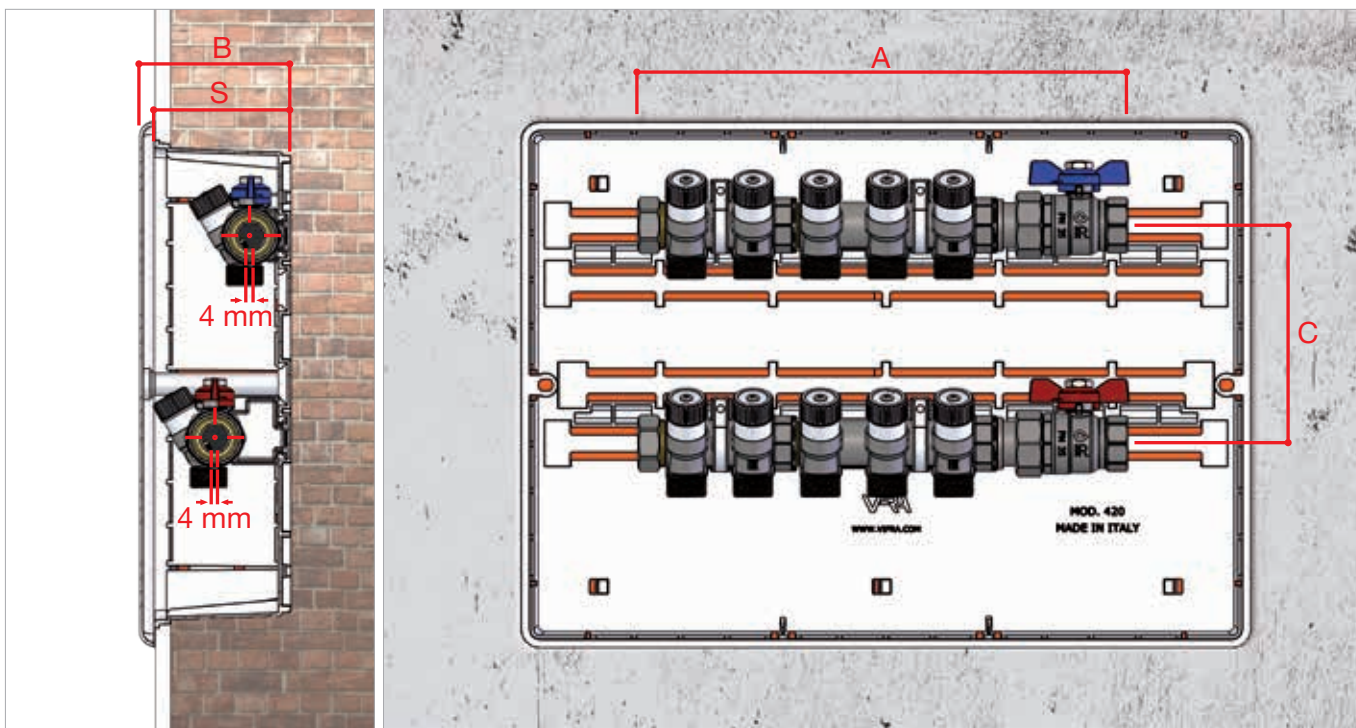

The chart below shows the overall dimensions for the combination of two simple modular manifolds and a full-flow ball valve.

With these sizes, considering to allow 50 mm free space on the side of the ball valve, it is possible to choose the plastic wall cabinet with the fixing structures and brackets whose external sizes are listed below.

		CF 477						CF 479				
OUTLETS N°	Ø	A	B	C	S	CABINETS	WALL CABINETS DIMENSIONS	B	C	S	CABINETS	WALL CABINETS DIMENSIONS
2	G 3/4	175	100	110	86	68560432	272 x 332 x 86	98	140	88	68560332	290 x 330 x 88
3	G 3/4	215	100	110	86	68560432	272 x 332 x 86	98	140	88	68560332	290 x 330 x 88
4	G 3/4	255	100	110	86	68560432	272 x 332 x 86	98	140	88	68560332	290 x 330 x 88
3 + 2	G 3/4	295	100	110	86	68560440	272 x 412 x 86	98	130	88	68560342	310 x 430 x 88
3 + 3	G 3/4	335	100	110	86	68560440	272 x 412 x 86	98	130	88	68560342	310 x 430 x 88
3 + 4	G 3/4	375	100	110	86	68560450	272 x 512 x 86	98	150	88	68560352	330 x 530 x 88
4 + 4	G 3/4	415	100	110	86	68560450	272 x 512 x 86	98	150	88	68560352	330 x 530 x 88
2	G 1"	175	100	110	86	68560432	272 x 332 x 86	98	140	88	68560332	290 x 330 x 88
3	G 1"	215	100	110	86	68560432	272 x 332 x 86	98	140	88	68560332	290 x 330 x 88
4	G 1"	255	100	110	86	68560440	272 x 412 x 86	98	130	88	68560342	310 x 430 x 88
3 + 2	G 1"	295	100	110	86	68560440	272 x 412 x 86	98	130	88	68560342	310 x 430 x 88
3 + 3	G 1"	335	100	110	86	68560440	272 x 412 x 86	98	130	88	68560342	310 x 430 x 88
3 + 4	G 1"	375	100	110	86	68560450	272 x 512 x 86	98	150	88	68560352	330 x 530 x 88
4 + 4	G 1"	415	100	110	86	68560450	272 x 512 x 86	98	150	88	68560352	330 x 530 x 88

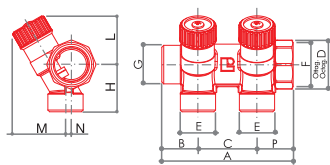

SIMPLE MODULAR MANIFOLDS WITH SHUT-OFF VALVES: CONNECTION FOR COPPER AND PLASTIC PIPE W24X19

**CP 432**

2-way simple modular manifold with shut-off valves. Connection for copper and plastic pipe (W24x19). In compliance with D.M. 174/2004.

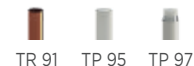
Fittings



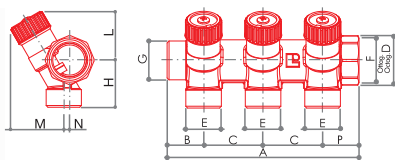

CODE	SIZE	A	B	C	D	E	F	G	H	L	M	N	P			
68512702	G 3/4 x (W24x19)	91,5	25	40	31	W24x19	G 3/4	G 3/4	32	34	36	4	26,5	300	6	48
68513402	G 1" x (W24x19)	91	24,5	40	38	W24x19	G 1"	G 1"	34	36	40	3	26,5	320	5	40

**CP 433**

3-way simple modular manifold with shut-off valves. Connection for copper and plastic pipe (W24x19). In compliance with D.M. 174/2004.

Fittings





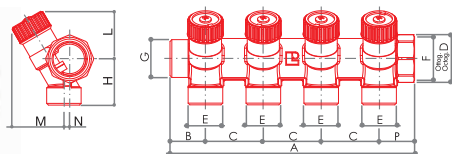

CODE	SIZE	A	B	C	D	E	F	G	H	L	M	N	P			
68512703	G 3/4 x (W24x19)	131,5	25	40	31	W24x19	G 3/4	G 3/4	32	34	36	4	26,5	432	5	40
68513403	G 1" x (W24x19)	131	24,5	40	38	W24x19	G 1"	G 1"	34	36	40	3	26,5	458	4	32

**CP 434**

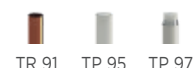
4-way simple modular manifold with shut-off valves. Connection for copper and plastic pipe (W24x19). In compliance with D.M. 174/2004.

Fittings



CODE	SIZE	A	B	C	D	E	F	G	H	L	M	N	P			
68512704	G 3/4 x (W24x19)	171,5	25	40	31	W24x19	G 3/4	G 3/4	32	34	36	4	26,5	562	4	32
68513404	G 1" x (W24x19)	171	24,5	40	38	W24x19	G 1"	G 1"	34	36	40	3	26,5	640	3	24

**SIMPLE MODULAR MANIFOLDS WITH SHUT-OFF VALVES:
CONNECTION FOR COPPER AND PLASTIC PIPE G 3/4 EUROKONUS**

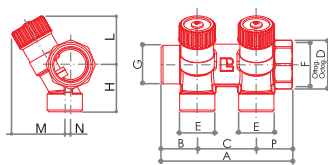

CP 452

2-way simple modular manifold with shut-off valves. Connection for copper and plastic pipe G 3/4 EK. In compliance with D.M. 174/2004.

Fittings



CODE	SIZE	A	B	C	D	E	F	G	H	L	M	N	P			
68512802	G 3/4 x G 3/4 EK	91,5	25	40	31	G 3/4 EK	G 3/4	G 3/4	32	34	36	4	26,5	309	6	48
68513502	G 1" x G 3/4 EK	91	24,5	40	38	G 3/4 EK	G 1"	G 1"	34	36	40	3	26,5	337	5	40

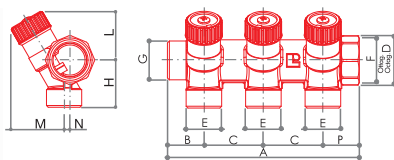

CP 453

3-way simple modular manifold with shut-off valves. Connection for copper and plastic pipe G 3/4 EK. In compliance with D.M. 174/2004.

Fittings



CODE	SIZE	A	B	C	D	E	F	G	H	L	M	N	P			
68512803	G 3/4 x G 3/4 EK	131,5	25	40	31	G 3/4 EK	G 3/4	G 3/4	32	34	36	4	26,5	430	5	40
68513503	G 1" x G 3/4 EK	131	24,5	40	38	G 3/4 EK	G 1"	G 1"	34	36	40	3	26,5	490	4	32

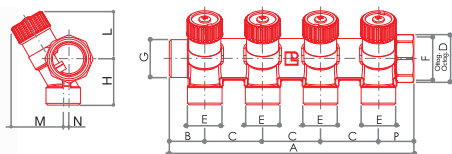

CP 454

4-way simple modular manifold with shut-off valves. Connection for copper and plastic pipe G 3/4 EK. In compliance with D.M. 174/2004.

Fittings



CODE	SIZE	A	B	C	D	E	F	G	H	L	M	N	P			
68512804	G 3/4 x G 3/4 EK	171,5	25	40	31	G 3/4 EK	G 3/4	G 3/4	32	34	36	4	26,5	562	4	32
68513504	G 1" x G 3/4 EK	171	24,5	40	38	G 3/4 EK	G 1"	G 1"	34	36	40	3	26,5	640	3	24

SIMPLE MODULAR MANIFOLDS WITH SHUT-OFF VALVES: CONNECTION FOR COPPER AND PLASTIC PIPE G1/2

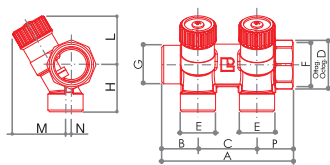

CP 462

2-way simple modular manifold with shut-off valves. Connection for copper and plastic pipe G 1/2. In compliance with D.M. 174/2004.

Fittings



CODE	SIZE	A	B	C	D	E	F	G	H	L	M	N	P			
68512602	G 3/4 x G 1/2	91,5	25	40	31	G 1/2	G 3/4	G 3/4	32	34	36	4	26,5	309	6	48
68513302	G 1" x G 1/2	91	24,5	40	38	G 1/2	G 1"	G 1"	34	36	40	3	26,5	335	5	40

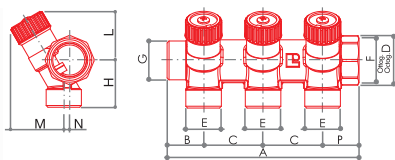

CP 463

3-way simple modular manifold with shut-off valves. Connection for copper and plastic pipe G 1/2. In compliance with D.M. 174/2004.

Fittings



CODE	SIZE	A	B	C	D	E	F	G	H	L	M	N	P			
68512603	G 3/4 x G 1/2	131,5	25	40	31	G 1/2	G 3/4	G 3/4	32	34	36	4	26,5	430	5	40
68513303	G 1" x G 1/2	131	24,5	40	38	G 1/2	G 1"	G 1"	34	36	40	3	26,5	487	4	32

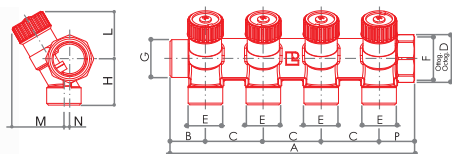

CP 464

4-way simple modular manifold with shut-off valves. Connection for copper and plastic pipe G 1/2. In compliance with D.M. 174/2004.

Fittings



CODE	SIZE	A	B	C	D	E	F	G	H	L	M	N	P			
68512604	G 3/4 x G 1/2	171,5	25	40	31	G 1/2	G 3/4	G 3/4	32	34	36	4	26,5	562	4	32
68513304	G 1" x G 1/2	171	24,5	40	38	G 1/2	G 1"	G 1"	34	36	40	3	26,5	636	3	24

REPLACEMENTS



IU 436

Label indicating connected devices for sanitary manifolds.

CODE	SIZE			
ETICHCS	-	-	-	-



IU 437

Pair of red/blue aluminium discs and indication of utilities for sanitary manifolds.

CODE	SIZE			
6801615	-	1	-	-



571

ABS manual adjustment knob for CP manifolds, white coloured (RAL 9016).

CODE	SIZE			
4761624	-	4	-	-



580

Brass screw for manual adjustment knob for Tekna valves.

CODE	SIZE			
9346615	-	1	-	-

MANIFOLDS FLOW RATE CHART

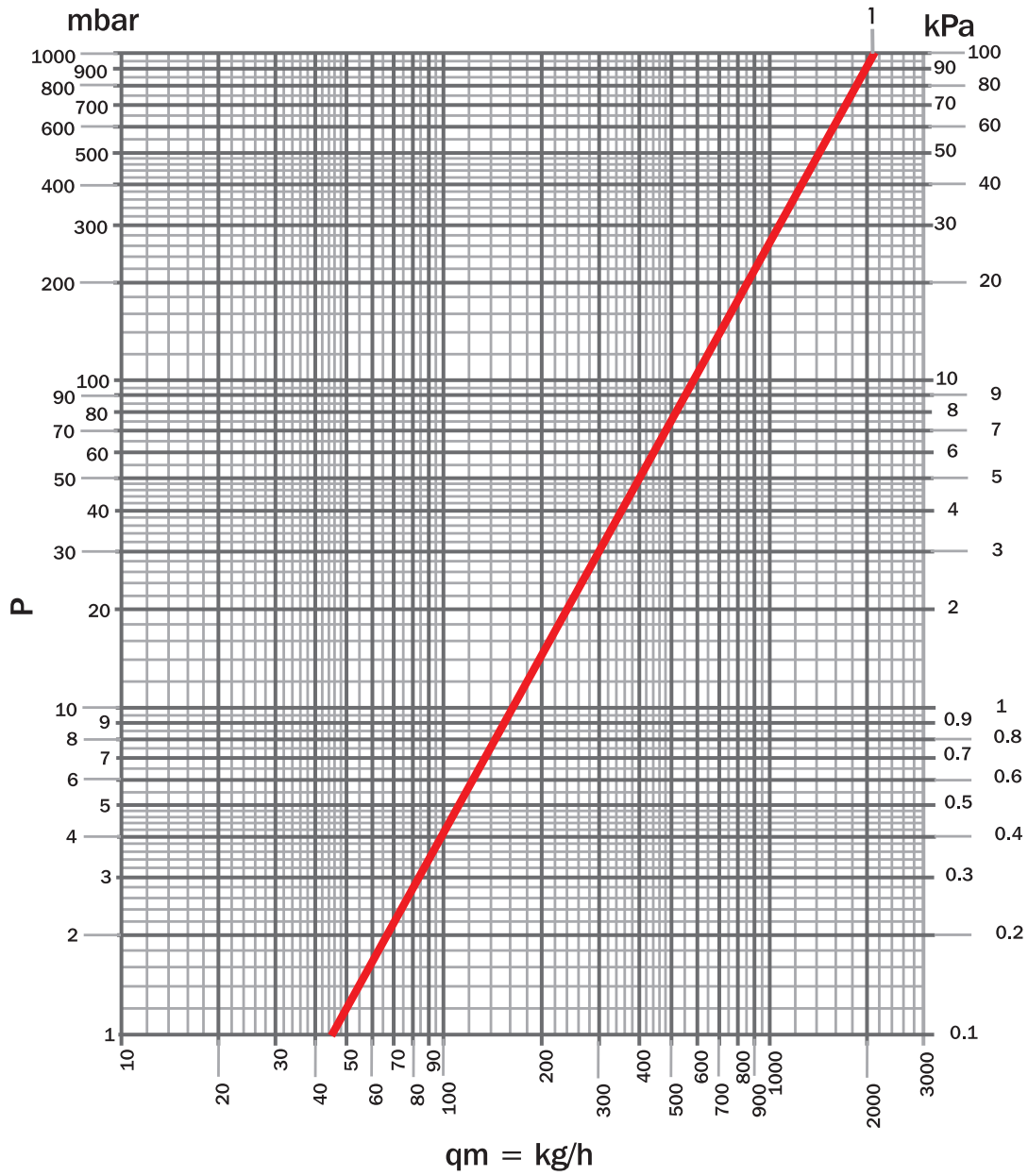

ITEM	SIZE	TURNS N°	Kvs	POS
CP 432 CP 433 CP 434 CP 452 CP 453 CP 454 CP 462 CP 463 CP 464	G 3/4	all open	2,1	1
	G 1"			

CP

SIMPLE MODULAR MANIFOLDS WITH AUTOMATIC ALIGNMENT AND SHUT-OFF VALVES



*In compliance with
D.M. 174/2004

CP manifolds feature a fixed stem whose tightness is ensured by two O rings, and by a flat gasket when in closed position. All manifolds are supplied with labels indicating the various utilities.

CP manifolds are machined after the nickel plating phase, so

as to comply with Italian regulation D.M. 174/2004 about the transport of drinking water.

All manifolds undergo a post weld heat treatment to eliminate any tension caused from processing.

TECHNICAL DATA



Max temperature

120 °C



Max pressure

10 bar



Materials

CW617N
UNI EN
12165:2016



Knob

white ABS
RAL 9016

SYSTEM CONNECTIONS

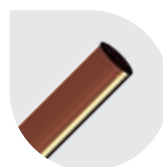

Copper pipe

W 24x19 - TR 91
G 3/4 EK - TR 91/A
G 1/2 - TR 890



Plastic pipe

W 24x19 - TP 95
G 3/4 EK - TP 98
G 1/2 - TP 93



Multilayer pipe

W 24x19 - TP 97
G 3/4 EK - TP 99
G 1/2 - TP 96

MAIN BODY CONNECTION



G 3/4
G 1"

CENTRE TO CENTRE DISTANCE



40 mm



The outlets are 4mm offset to facilitate the installation of the fittings inside the cabinet.

AUTOMATIC ALIGNMENT

Manifolds CP series with special threads can be connected in a very easy and intuitive way. Thanks to their special threads manifolds CP series are always aligned and their tightness is guaranteed by an O-ring. Therefore these manifolds do not require any other intermediate sealing element (PTFE, hemp, etc.) and their installation is quicker.

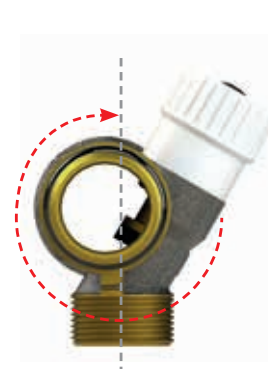
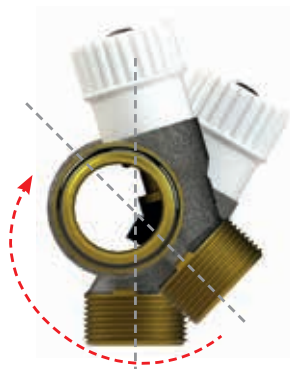

The characteristics of the fluid in the system must be compliant with the UNI 8065: 2019 directive.

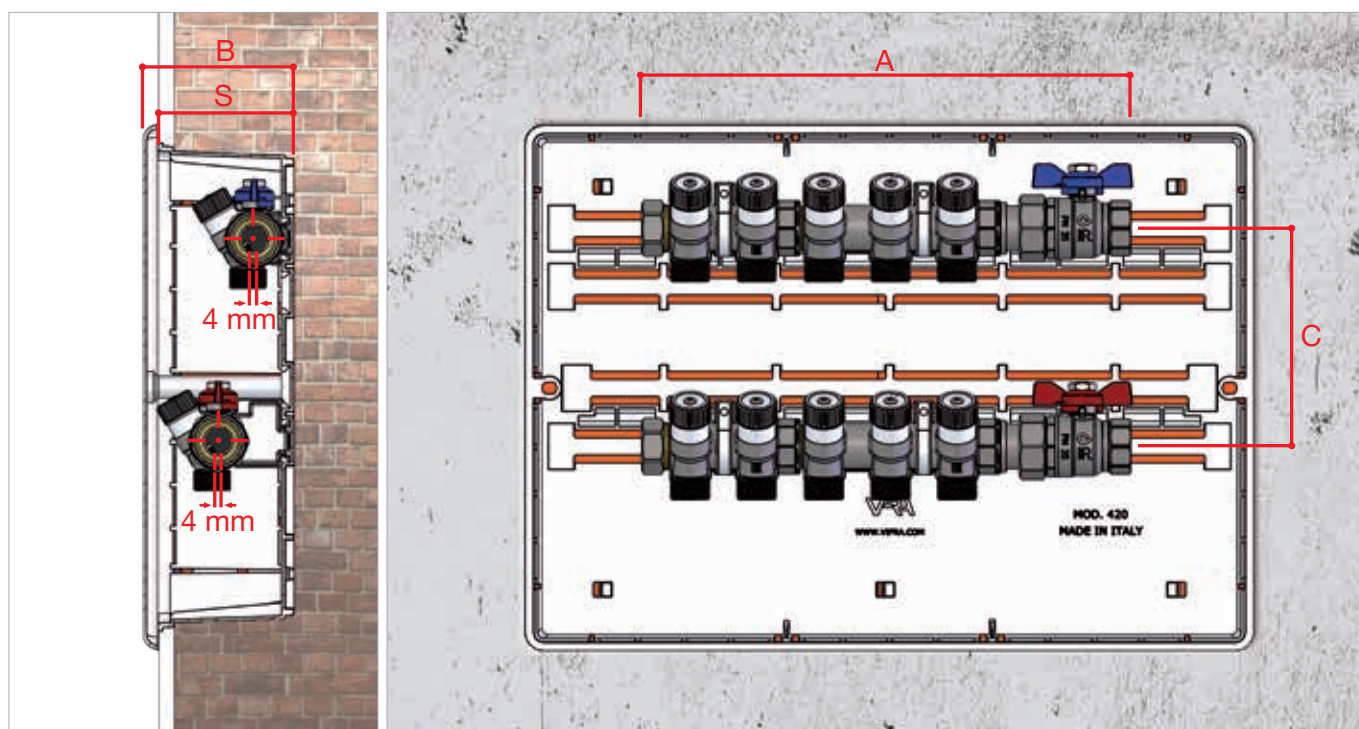

The chart below shows the overall dimensions for the combination of two simple modular manifolds and a full-flow ball valve.

With these sizes, considering to allow 50 mm free space on the side of the ball valve, it is possible to choose the plastic wall cabinet with the fixing structures and brackets whose external sizes are listed below.

		CF 477						CF 479				
OUTLETS N°	Ø	A	B	C	S	CABINETS	WALL CABINETS DIMENSIONS	B	C	S	CABINETS	WALL CABINETS DIMENSIONS
2	G 3/4	175	100	110	86	68560432	272 x 332 x 86	98	140	88	68560332	290 x 330 x 88
3	G 3/4	215	100	110	86	68560432	272 x 332 x 86	98	140	88	68560332	290 x 330 x 88
4	G 3/4	255	100	110	86	68560432	272 x 332 x 86	98	140	88	68560332	290 x 330 x 88
3 + 2	G 3/4	295	100	110	86	68560440	272 x 412 x 86	98	130	88	68560342	310 x 430 x 88
3 + 3	G 3/4	335	100	110	86	68560440	272 x 412 x 86	98	130	88	68560342	310 x 430 x 88
3 + 4	G 3/4	375	100	110	86	68560450	272 x 512 x 86	98	150	88	68560352	330 x 530 x 88
4 + 4	G 3/4	415	100	110	86	68560450	272 x 512 x 86	98	150	88	68560352	330 x 530 x 88
2	G 1"	175	100	110	86	68560432	272 x 332 x 86	98	140	88	68560332	290 x 330 x 88
3	G 1"	215	100	110	86	68560432	272 x 332 x 86	98	140	88	68560332	290 x 330 x 88
4	G 1"	255	100	110	86	68560440	272 x 412 x 86	98	130	88	68560342	310 x 430 x 88
3 + 2	G 1"	295	100	110	86	68560440	272 x 412 x 86	98	130	88	68560342	310 x 430 x 88
3 + 3	G 1"	335	100	110	86	68560440	272 x 412 x 86	98	130	88	68560342	310 x 430 x 88
3 + 4	G 1"	375	100	110	86	68560450	272 x 512 x 86	98	150	88	68560352	330 x 530 x 88
4 + 4	G 1"	415	100	110	86	68560450	272 x 512 x 86	98	150	88	68560352	330 x 530 x 88

**SIMPLE MODULAR MANIFOLDS WITH AUTOMATIC ALIGNMENT AND SHUT-OFF VALVES:
CONNECTION FOR COPPER AND PLASTIC PIPE W24X19**

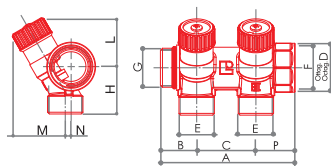

CP 432/FR

2-way simple modular manifold with automatic alignment and shut-off valves. Connection for copper and plastic pipe (W24x19). In compliance with D.M. 174/2004.

Fittings



CODE	SIZE	A	B	C	D	E	F	G	H	L	M	N	P			
68512702FR	G 3/4 x (W24x19)	91	24,5	40	31	W24x19	G 3/4	G 3/4	32	34	36	4	26,5	305	6	48
68513402FR	G 1" x (W24x19)	91,5	24,5	40	38	W24x19	G 1"	G 1"	34	36	40	3	27	325	5	40

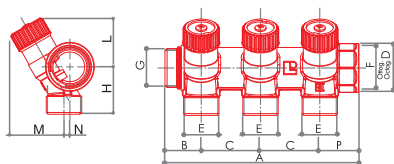

CP 433/FR

3-way simple modular manifold with automatic alignment and shut-off valves. Connection for copper and plastic pipe (W24x19). In compliance with D.M. 174/2004.

Fittings

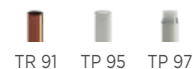

CODE	SIZE	A	B	C	D	E	F	G	H	L	M	N	P			
68512703FR	G 3/4 x (W24x19)	131	24,5	40	31	W24x19	G 3/4	G 3/4	32	34	36	4	26,5	437	5	40
68513403FR	G 1" x (W24x19)	131,5	24,5	40	38	W24x19	G 1"	G 1"	34	36	40	3	27	463	4	32

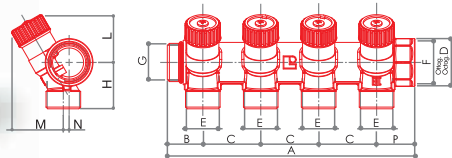

CP 434/FR

4-way simple modular manifold with automatic alignment and shut-off valves. Connection for copper and plastic pipe (W24x19). In compliance with D.M. 174/2004.

Fittings

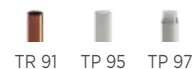

CODE	SIZE	A	B	C	D	E	F	G	H	L	M	N	P			
68512704FR	G 3/4 x (W24x19)	171	24,5	40	31	W24x19	G 3/4	G 3/4	32	34	36	4	26,5	567	4	32
68513404FR	G 1" x (W24x19)	171,5	24,5	40	38	W24x19	G 1"	G 1"	34	36	40	3	27	645	3	24

SIMPLE MODULAR MANIFOLDS WITH AUTOMATIC ALIGNMENT AND SHUT-OFF VALVES: CONNECTION FOR COPPER AND PLASTIC PIPE G3/4 EUROKONUS

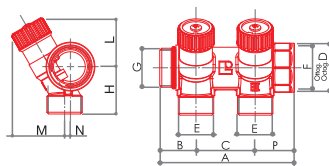



CP 452/FR

2-way simple modular manifold with automatic alignment and shut-off valves. Connection for copper and plastic pipe G 3/4 EK. In compliance with D.M. 174/2004.

Fittings



CODE	SIZE	A	B	C	D	E	F	G	H	L	M	N	P			
68512802FR	G 3/4 x G 3/4 EK	91	24,5	40	31	G 3/4 EK	G 3/4	G 3/4	32	34	36	4	26,5	325	6	48
68513502FR	G 1" x G 3/4 EK	91,5	24,5	40	38	G 3/4 EK	G 1"	G 1"	34	36	40	3	27	342	5	40

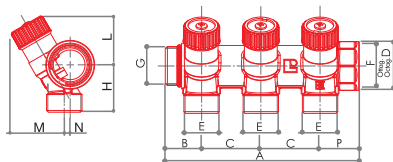



CP 453/FR

3-way simple modular manifold with automatic alignment and shut-off valves. Connection for copper and plastic pipe G 3/4 EK. In compliance with D.M. 174/2004.

Fittings



CODE	SIZE	A	B	C	D	E	F	G	H	L	M	N	P			
68512803FR	G 3/4 x G 3/4 EK	131	24,5	40	31	G 3/4 EK	G 3/4	G 3/4	32	34	36	4	26,5	435	5	40
68513503FR	G 1" x G 3/4 EK	131,5	24,5	40	38	G 3/4 EK	G 1"	G 1"	34	36	40	3	27	495	4	32

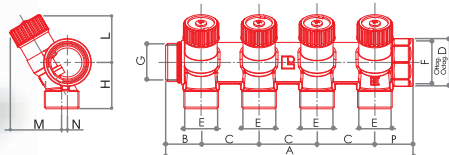



CP 454/FR

4-way simple modular manifold with automatic alignment and shut-off valves. Connection for copper and plastic pipe G 3/4 EK. In compliance with D.M. 174/2004.

Fittings



CODE	SIZE	A	B	C	D	E	F	G	H	L	M	N	P			
68512804FR	G 3/4 x G 3/4 EK	171	24,5	40	31	G 3/4 EK	G 3/4	G 3/4	32	34	36	4	26,5	567	4	32
68513504FR	G 1" x G 3/4 EK	171,5	24,5	40	38	G 3/4 EK	G 1"	G 1"	34	36	40	3	27	645	3	24

**SIMPLE MODULAR MANIFOLDS WITH AUTOMATIC ALIGNMENT AND SHUT-OFF VALVES:
CONNECTION FOR COPPER AND PLASTIC PIPE G1/2**

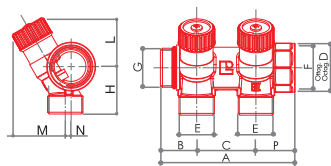

CP 462/FR

2-way simple modular manifold with automatic alignment and shut-off valves. Connection for copper and plastic pipe G 1/2. In compliance with D.M. 174/2004.

Fittings

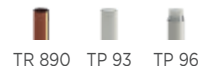

CODE	SIZE	A	B	C	D	E	F	G	H	L	M	N	P			
68512602FR	G 3/4 x G 1/2	91	24,5	40	31	G 1/2	G 3/4	G 3/4	32	34	36	4	26,5	314	6	48
68513302FR	G 1" x G 1/2	91,5	24,5	40	38	G 1/2	G 1"	G 1"	34	36	40	3	27	340	5	40

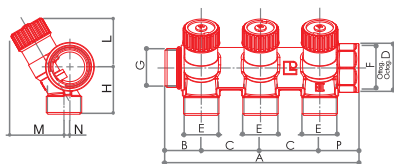

CP 463/FR

3-way simple modular manifold with automatic alignment and shut-off valves. Connection for copper and plastic pipe G 1/2. In compliance with D.M. 174/2004.

Fittings



CODE	SIZE	A	B	C	D	E	F	G	H	L	M	N	P			
68512603FR	G 3/4 x G 1/2	131	24,5	40	31	G 1/2	G 3/4	G 3/4	32	34	36	4	26,5	435	5	40
68513303FR	G 1" x G 1/2	131,5	24,5	40	38	G 1/2	G 1"	G 1"	34	36	40	3	27	492	4	32

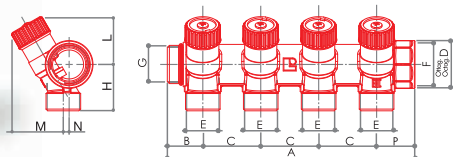

CP 464/FR

4-way simple modular manifold with automatic alignment and shut-off valves. Connection for copper and plastic pipe G 1/2. In compliance with D.M. 174/2004.

Fittings

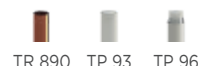

CODE	SIZE	A	B	C	D	E	F	G	H	L	M	N	P			
68512604FR	G 3/4 x G 1/2	171	24,5	40	31	G 1/2	G 3/4	G 3/4	32	34	36	4	26,5	567	4	32
68513304FR	G 1" x G 1/2	171,5	24,5	40	38	G 1/2	G 1"	G 1"	34	36	40	3	27	641	3	24

REPLACEMENTS



IU 436

Label indicating connected devices for sanitary manifolds.

CODE	SIZE			
ETICHCS	-	-	-	-



IU 437

Pair of red/blue aluminium discs and indication of utilities for sanitary manifolds.

CODE	SIZE			
6801615	-	1	-	-



571

ABS manual adjustment knob for CP manifolds, white coloured (RAL 9016).

CODE	SIZE			
4761624	-	4	-	-



580

Brass screw for manual adjustment knob for Tekna valves.

CODE	SIZE			
9346615	-	1	-	-

MANIFOLDS FLOW RATE CHART

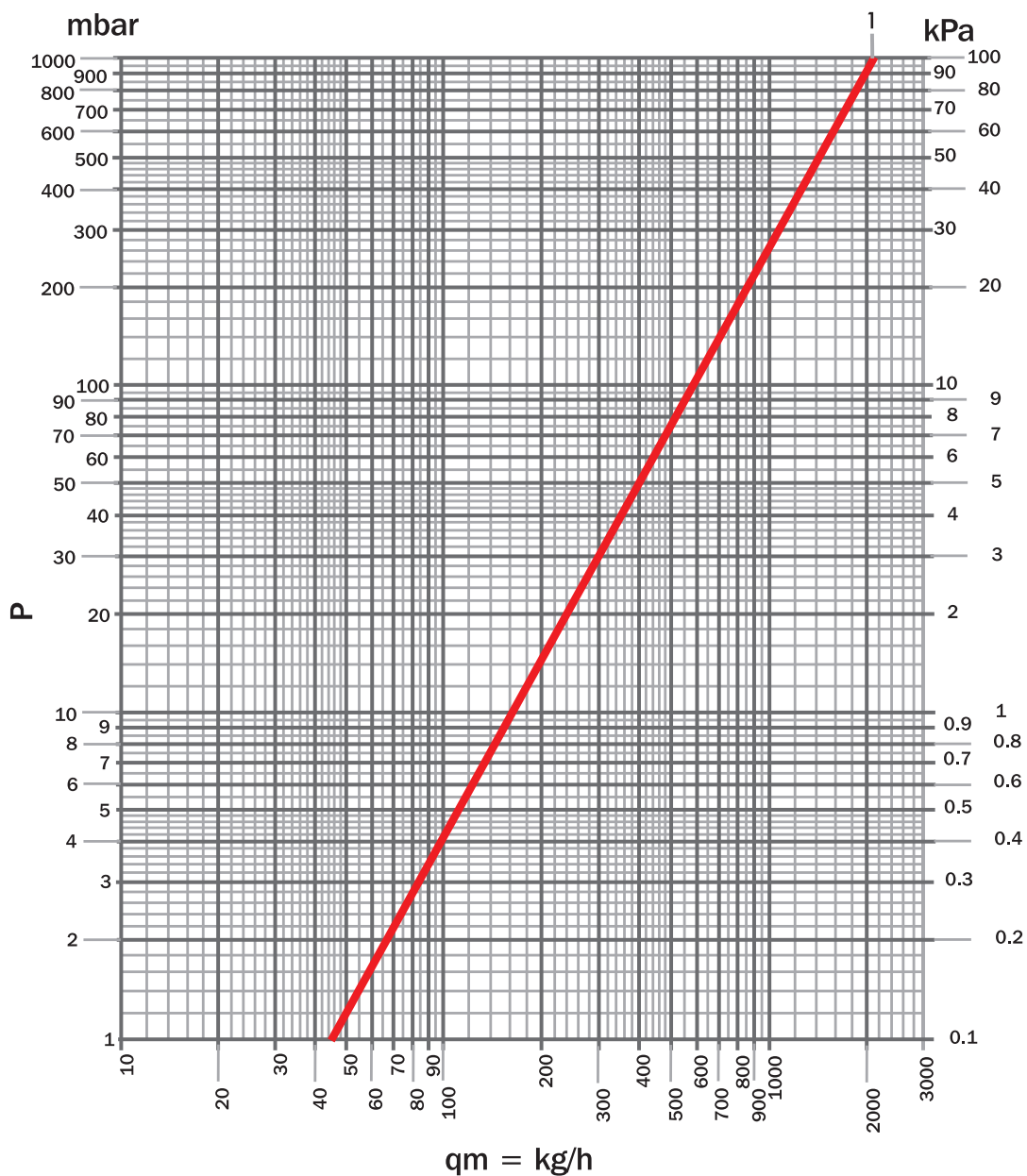

ITEM	SIZE	TURNS N°	Kvs	POS
CP 432/FR CP 433/FR CP 434/FR CP 452/FR CP 453/FR CP 454/FR CP 462/FR CP 463/FR CP 464/FR	G 3/4	all open	2,1	1
	G 1"			



LUXOR®

MODULAR MANIFOLDS WITH FRONT VALVES

2.2 / CV SERIES

CV

MODULAR MANIFOLDS WITH FRONT VALVES



The modular manifolds with front shut-off valves are simply and easily connected to each other. The various utilities are independent from each other thanks to the shut off valves

and can be easily identified using the two silk-screened disks. The CV series manifold allow to adjust and balance each single users. Models with 2 to 4 outlets available.

TECHNICAL DATA



Max temperature
120 °C



Max working pressure
16 bar



Max differential pressure
1 bar



Body materials
CB753S
UNI EN
1982:2017



Shutter materials
CW614N
DW UNI EN
12164:2016



Gaskets material
EPDM
peroxide



Stem o-ring material
NBR



Knob
Nylon PA6
RAL 9016



Testing
100%



Finishing
Chrome

SYSTEM CONNECTIONS

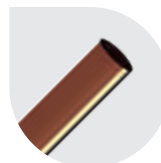

Copper pipe
W 24x19 - TR 91
G 3/4 EK - TR 91/A



Plastic pipe
W 24x19 - TP 95
G 3/4 EK - TP 98



Multilayer pipe
W 24x19 - TP 97
G 3/4 EK - TP 99

MAIN BODY CONNECTION

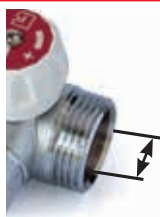

G 3/4
G 1"

CENTRE TO CENTRE DISTANCE



45 mm

The characteristics of the fluid in the system must be compliant with the UNI 8065: 2019 directive.

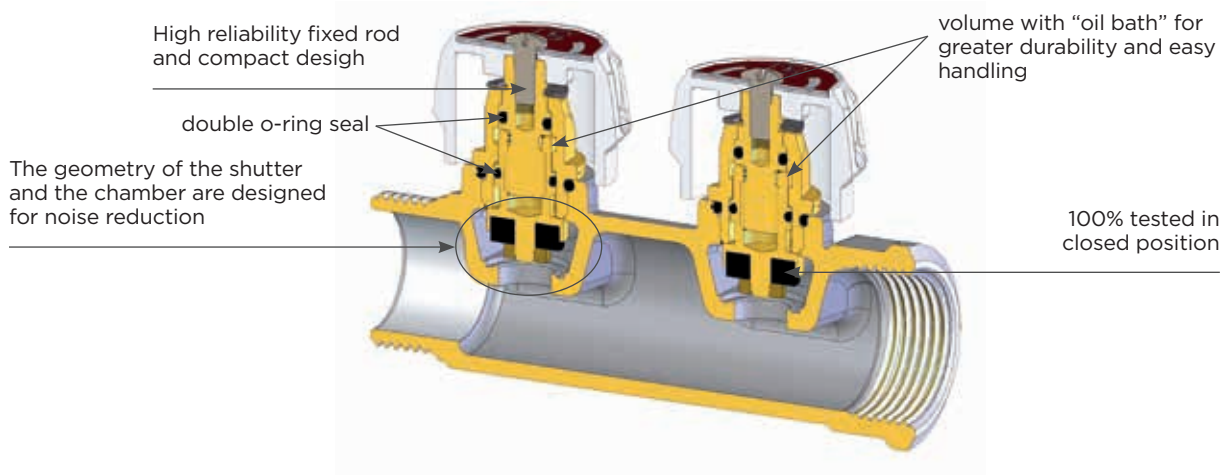

OPERATING INSTRUCTIONS



It is possible to use the aluminium discs supplied with the manifolds to identify the utilities.

For correct assembly of the utilities disks, choose whether to leave the blue side or the red side of the disc visible. The plate is equipped with a window from which it is possible to read the user being served by the manifold. Place the silk-screened metal disc before the red or blue plate so that the name of the delivery terminal is visible from the window, as shown in the image.

Once the indicator has been positioned, fix the metal plate to the knob with the screw on the knob itself.

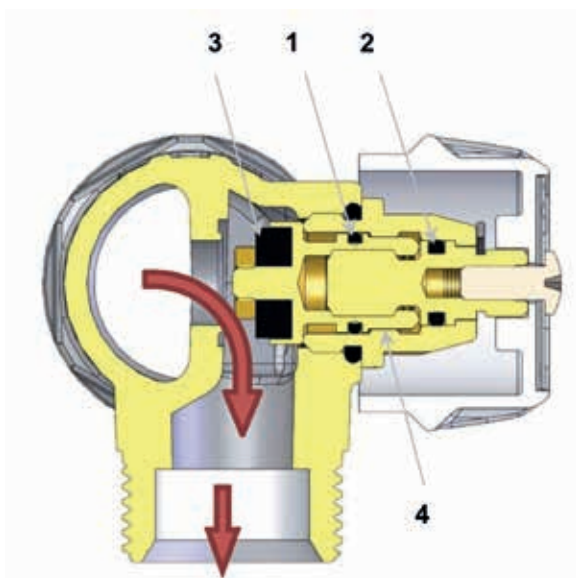

The modular manifold with front shut-off valves must be installed with the inlet water flow as shown in the image on the side.

The manifold headwork is safe and reliable as it has a fixed rod whose seal is guaranteed by two EPDM peroxide o-rings (1-2) while the sealing, when closed with the obturator, is guaranteed by a flat gasket in NBR (3).

A sealed chamber (4) is created inside the valve where lubricating grease is deposited. In this way, the smooth opening and closing movement is guaranteed over time.

The construction of the screw allows the adjustment and balancing of each single user (outlet)

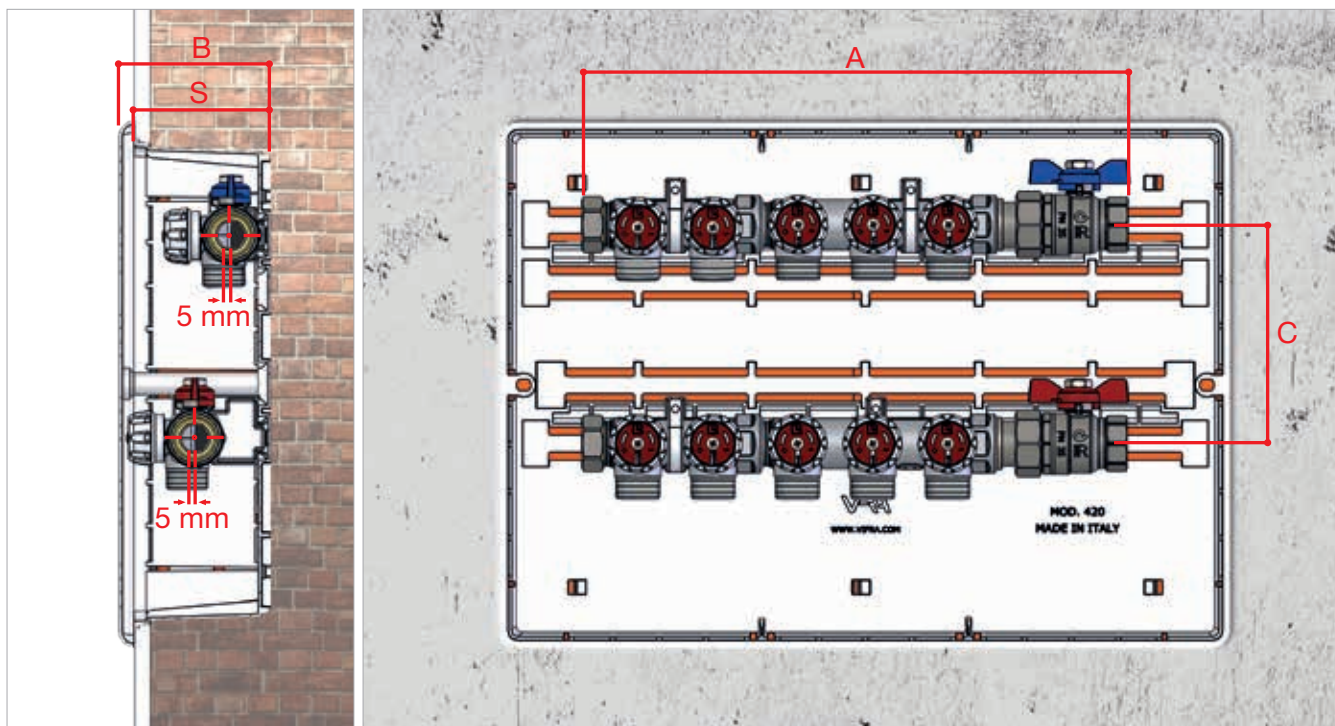

The chart below shows the overall dimensions for the combination of two modular manifolds and a full-flow ball valve.

With these sizes, considering to allow 50 mm free space on the side of the ball valve, it is possible to choose the plastic wall cabinet with the fixing structures and brackets whose external sizes are listed below.

		CF 477						CF 479				
OUTLETS N°	Ø	A	B	C	S	CABINETS	WALL CABINETS DIMENSIONS	B	C	S	CABINETS	WALL CABINETS DIMENSIONS
2	G 3/4	190	100	110	86	68560432	272 x 332 x 86	98	140	88	68560332	290 x 330 x 88
3	G 3/4	235	100	110	86	68560432	272 x 332 x 86	98	140	88	68560332	290 x 330 x 88
4	G 3/4	280	100	110	86	68560432	272 x 332 x 86	98	140	88	68560332	290 x 330 x 88
2 + 3	G 3/4	330	100	110	86	68560440	272 x 412 x 86	98	130	88	68560342	310 x 430 x 88
3 + 3	G 3/4	375	100	110	86	68560440	272 x 412 x 86	98	130	88	68560342	310 x 430 x 88
3 + 4	G 3/4	420	100	110	86	68560450	272 x 512 x 86	98	150	88	68560352	330 x 530 x 88
4 + 4	G 3/4	465	100	110	86	68560450	272 x 512 x 86	98	150	88	68560352	330 x 530 x 88
2	G 1"	192	100	110	86	68560432	272 x 332 x 86	98	140	88	68560332	290 x 330 x 88
3	G 1"	238	100	110	86	68560432	272 x 332 x 86	98	140	88	68560332	290 x 330 x 88
4	G 1"	283	100	110	86	68560432	272 x 332 x 86	98	140	88	68560332	290 x 330 x 88
2 + 3	G 1"	337	100	110	86	68560440	272 x 412 x 86	98	130	88	68560342	310 x 430 x 88
3 + 3	G 1"	382	100	110	86	68560440	272 x 412 x 86	98	130	88	68560342	310 x 430 x 88
3 + 4	G 1"	427	100	110	86	68560450	272 x 512 x 86	98	150	88	68560352	330 x 530 x 88
4 + 4	G 1"	472	100	110	86	68560450	272 x 512 x 86	98	150	88	68560352	330 x 530 x 88

**MODULAR MANIFOLDS WITH FRONT VALVES:
CONNECTION FOR COPPER AND PLASTIC PIPE W24X19**

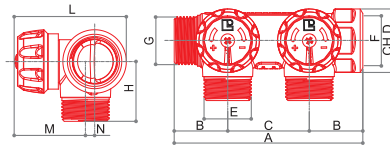

CV 532

2-way modular manifold with shut-off valves. Connection for copper and plastic pipe (W24x19).

Fittings



CODE	SIZE	A	B	C	D	E	F	G	H	L	M	N			
68202702	G 3/4 x (W24x19)	104	29,5	45	32	W24x19	G 3/4	G 3/4	33	61	38,5	5	470	1	45
68203402	G 1" x (W24x19)	108	31,5	45	37	W24x19	G 1"	G 1"	36	63	38,5	5	565	1	45

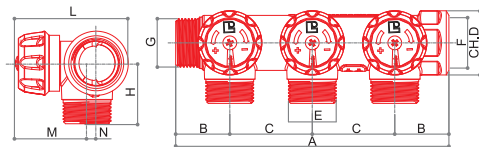

CV 533

3-way modular manifold with shut-off valves. Connection for copper and plastic pipe (W24x19).

Fittings



CODE	SIZE	A	B	C	D	E	F	G	H	L	M	N			
68202703	G 3/4 x (W24x19)	149	29,5	45	32	W24x19	G 3/4	G 3/4	33	61	38,5	5	690	1	34
68203403	G 1" x (W24x19)	153	31,5	45	37	W24x19	G 1"	G 1"	36	63	38,5	5	810	1	34

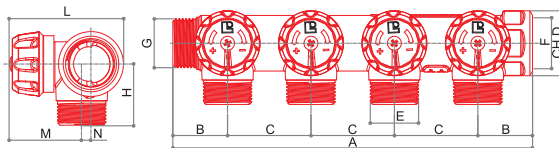

CV 534

4-way modular manifold with shut-off valves. Connection for copper and plastic pipe (W24x19).

Fittings



CODE	SIZE	A	B	C	D	E	F	G	H	L	M	N			
68202704	G 3/4 x (W24x19)	194	29,5	45	32	W24x19	G 3/4	G 3/4	33	61	38,5	5	890	1	25
68203404	G 1" x (W24x19)	198	31,5	45	37	W24x19	G 1"	G 1"	36	63	38,5	5	980	1	25



Raccordi per tubo rame



Raccordi per tubo plastica



Raccordi per tubo multistrato



Raccordi: capitolo 7



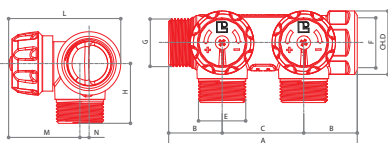

Accessori: capitolo 2.A

**MODULAR MANIFOLDS WITH FRONT VALVES:
COPPER AND PLASTIC PIPE G3/4 EUROKONUS**
**CV 552**

2-way modular manifold
with shut-off valves.
G3/4 Euroconus male
connections.

Fittings



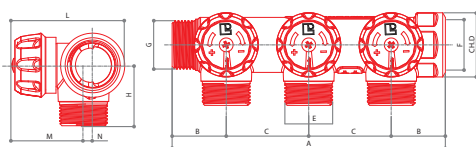

CODE	SIZE	A	B	C	D	E	F	G	H	L	M	N			
68202802	G 3/4 X G 3/4 EK	104	29,5	45	32	G 3/4 EK	G 3/4	G 3/4	33	61	38,5	5	470	1	45
68203502	G 1" X G 3/4 EK	108	31,5	45	37	G 3/4 EK	G 1"	G 1"	36	63	38,5	5	565	1	45

**CV 553**

3-way modular manifold
with shut-off valves.
G3/4 Euroconus male
connections.

Fittings



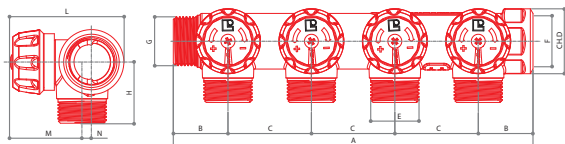

CODE	SIZE	A	B	C	D	E	F	G	H	L	M	N			
68202803	G 3/4 X G 3/4 EK	149	29,5	45	32	G 3/4 EK	G 3/4	G 3/4	33	61	38,5	5	690	1	34
68203503	G 1" X G 3/4 EK	153	31,5	45	37	G 3/4 EK	G 1"	G 1"	36	63	38,5	5	810	1	34

**CV 554**

4-way modular manifold
with shut-off valves. G3/4
Euroconus male connections.

Fittings





CODE	SIZE	A	B	C	D	E	F	G	H	L	M	N			
68202804	G 3/4 X G 3/4 EK	194	29,5	45	32	G 3/4 EK	G 3/4	G 3/4	33	61	38,5	5	890	1	25
68203504	G 1" X G 3/4 EK	198	31,5	45	37	G 3/4 EK	G 1"	G 1"	36	63	38,5	5	980	1	25

REPLACEMENTS



IU 438

Couple of red/blue aluminium discs and indication of utilities for sanitary manifolds for CV series.

CODE	SIZE			
6801617	-	1	-	-



573

ABS manual adjustment knob for CV series manifolds, white coloured (RAL 9016).

CODE	SIZE			
4761632	-	7	-	-



580

Brass screw for manual adjustment knob for Tekna valves.

CODE	SIZE			
9346615	-	1	-	-

MANIFOLDS FLOW RATE CHART

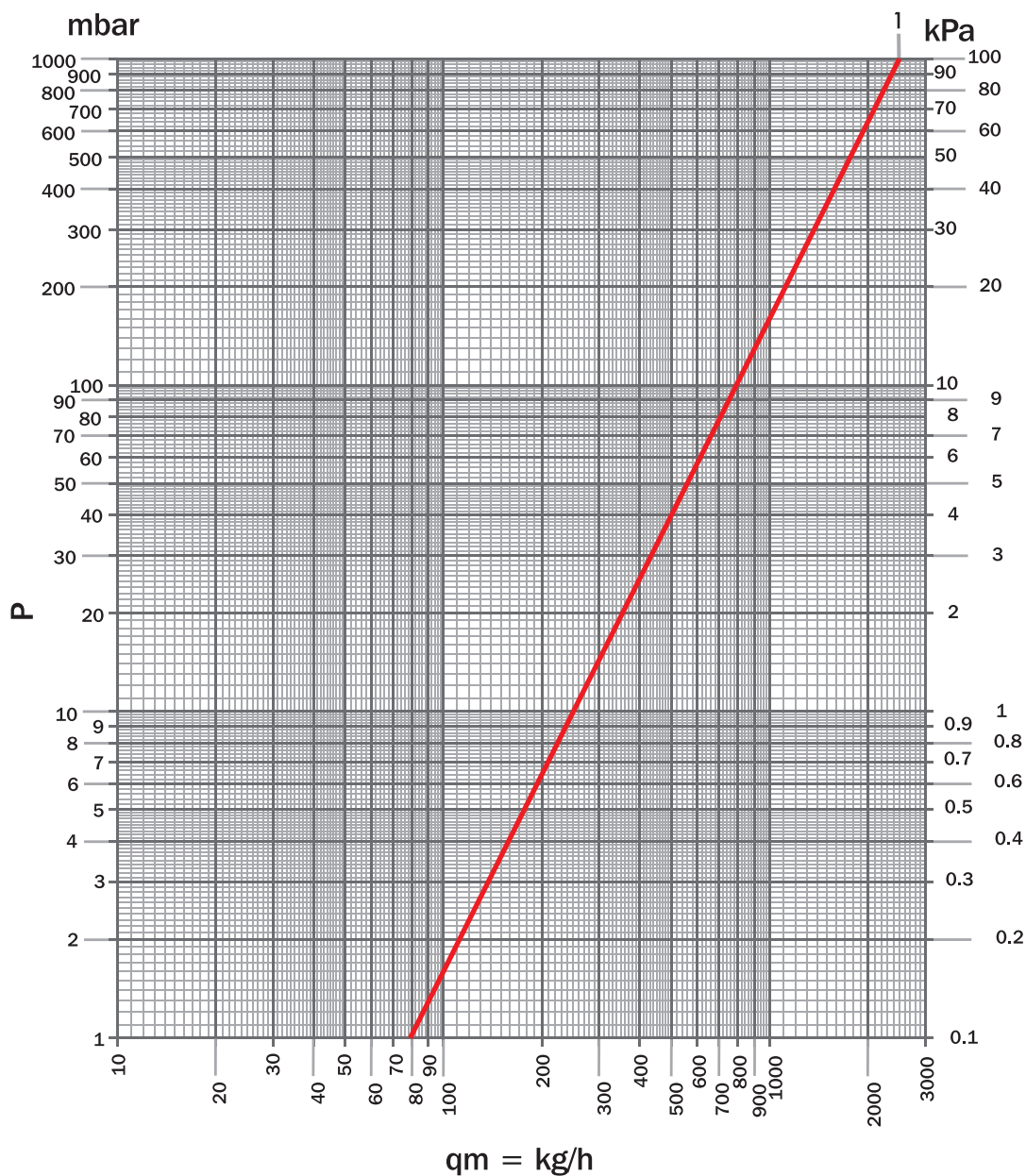

ITEM	SIZE	TURNS N°	Kvs	POS
CV 552 CV 553 CV 554	G 3/4	all open	2,5	1
	G 1"			



LUXOR®

COPLANAR MANIFOLDS

2.3 / CC SERIES

CC COPLANAR MANIFOLDS



All CC manifolds and their accessories are nickel-plated. Manifold bodies are produced by casting from EN 1982 brass with limited lead content.

The internal circuits connections enable the transport of high flow rates with very little noise.

TECHNICAL DATA



Max temperature

120 °C



Max pressure

10 bar



Materials

EN 1982

SYSTEM CONNECTIONS

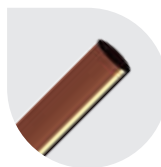

Copper pipe
W 24x19 - TR 91
G 3/4 EK - TR 91/A



Plastic pipe
W 24x19 - TP 95
G 3/4 EK - TP 98



Multilayer pipe
W 24x19 - TP 97
G 3/4 EK - TP 99

MAIN BODY CONNECTION

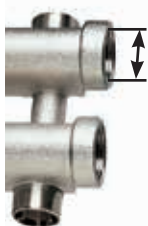

G 3/4
G 1"

CENTRE TO CENTRE DISTANCE

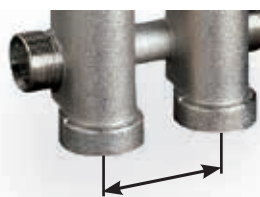

G 1" 50 mm
G 1 1/4" 55 mm



38 mm

DISTRIBUTION

Coplanar manifolds are suitable for water distribution in radial heating systems with horizontal distribution. In fact, the inlet and outlet connections to the circuits are staggered: this allows to easily connect the circuits without any inlet and outlet pipes overlapping.

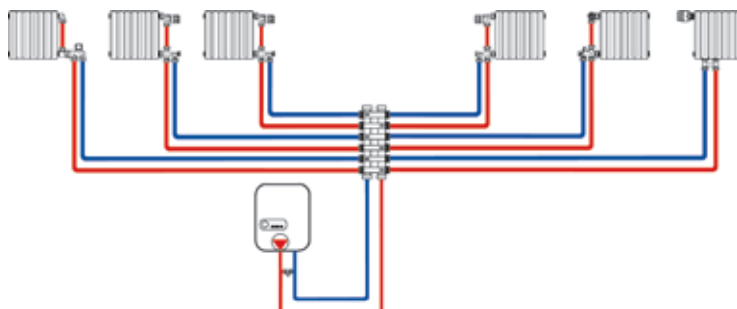

The characteristics of the fluid in the system must be compliant with the UNI 8065: 2019 directive.

COPLANAR MANIFOLDS

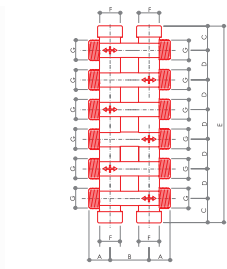

CC 414

Coplanar manifold with lateral male connections (W24x19).

Fittings



CODE	SIZE	OUTLETS N°	A	B	C	D	E	F	G	H	L			
68542704	G 3/4 x (W24x19)	4 + 4	27	50	26	38	166	G 3/4	W24x19	-	-	1300	1	18
68542706		6 + 6	27	50	26	38	242	G 3/4	W24x19	-	-	2030	1	12
68542708		8 + 8	27	50	26	38	318	G 3/4	W24x19	-	-	2408	1	9

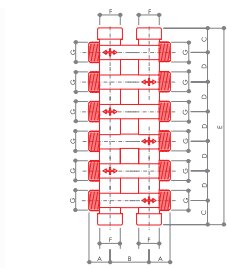

CC 416

Coplanar manifold with lateral male connections 3/4 eurokonus.

Fittings



CODE	SIZE	OUTLETS N°	A	B	C	D	E	F	G	H	L			
68542714	G 3/4 x G 3/4 EK	4 + 4	27	50	26	38	166	G 3/4	G 3/4 EK	-	-	1300	1	18
68542716		6 + 6	27	50	26	38	242	G 3/4	G 3/4 EK	-	-	2030	1	12
68542718		8 + 8	27	50	26	38	318	G 3/4	G 3/4 EK	-	-	2408	1	9

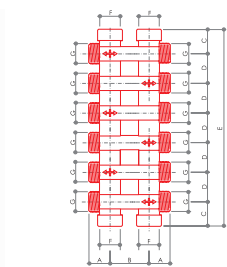

CC 413

Coplanar manifold with lateral male connections (W24x19).

Fittings



CODE	SIZE	OUTLETS N°	A	B	C	D	E	F	G	H	L			
68543406	G 1" x (W24x19)	6 + 6	30	55	30	38	250	G 1"	W24x19	-	-	2330	1	12
68543408		8 + 8	30	55	30	38	326	G 1"	W24x19	-	-	3248	1	9
68543410		10 + 10	30	55	30	38	402	G 1"	W24x19	-	-	4026	1	8

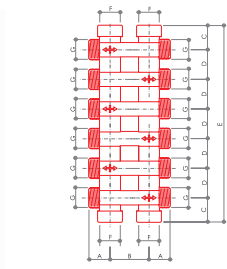

CC 415

Coplanar manifold with lateral male connections 3/4 eurokonus.

Fittings



CODE	SIZE	OUTLETS N°	A	B	C	D	E	F	G	H	L			
68543416	G 1" x G 3/4 EK	6 + 6	30	55	30	38	250	G 1"	G 3/4 EK	-	-	2330	1	12
68543418		8 + 8	30	55	30	38	326	G 1"	G 3/4 EK	-	-	3248	1	9
68543420		10 + 10	30	55	30	38	402	G 1"	G 3/4 EK	-	-	4026	1	8

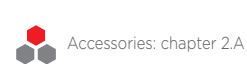
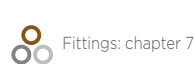
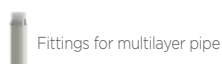
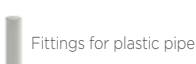
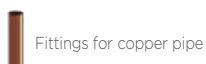

MANIFOLDS FLOW RATE CHART

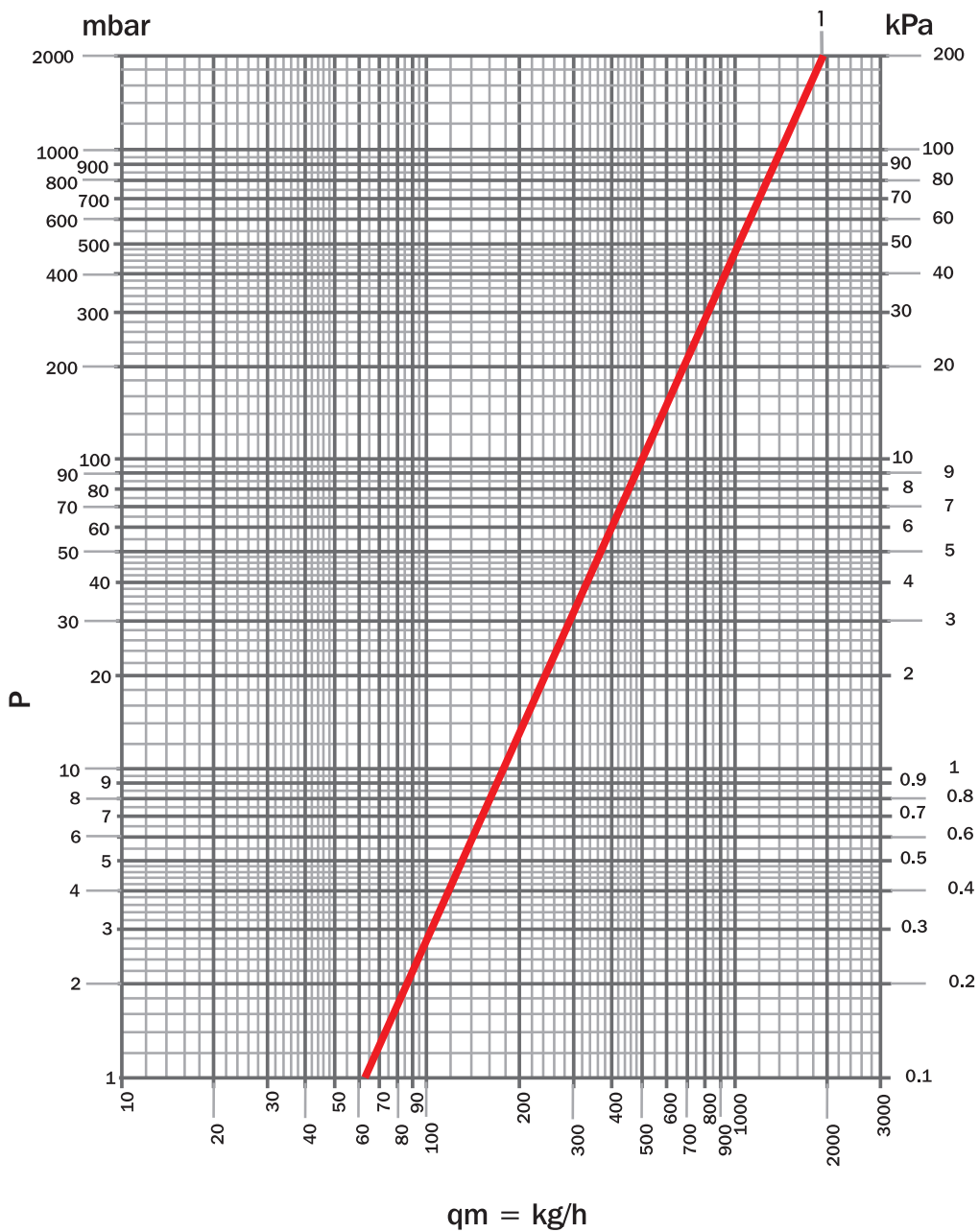

ITEM	SIZE	OUTLETS N°	Kvs	POS
CC 414 CC 416	G 3/4"	4 + 4	1,96	1
		6 + 6		
		8 + 8		
CC 413 CC 415	G 1"	6 + 6		
		8 + 8		
		10 + 10		



LUXOR®

DISTRIBUTION MANIFOLDS

2.4 / CD SERIES

CD DISTRIBUTION MANIFOLDS FOR HEATING SYSTEMS



*In compliance with
D.M. 174/2004

The CD series manifolds are obtained from drawn brass bar with yellow or nickel-plated finish.

All manifolds undergo a post weld heat treatment to eliminate any tension caused from processing. Do only use Luxor manifolds with Luxor accessories with soft o-ring sealing.

All of Luxor fittings and accessories for manifolds (such as drain valves, plugs, etc.) are provided with this kind of sealing and do not require the use of any intermediate element (PTFE, hemp, etc.), which could result in cracks.

We recommend to tighten the fittings to a maximum torque of 60 Nm.

TECHNICAL DATA



Max temperature
120 °C



Max pressure
10 bar



Materials
CW617N
UNI EN
12165:2016



Knob
white ABS
RAL 9016



Stem
AISI 316



Testing
100%

TECHNICAL SPECIFICATIONS WITH FLOW REGULATORS ART. TM 4012



Max temperature
70 °C



Max pressure
6 bar

SYSTEM CONNECTIONS

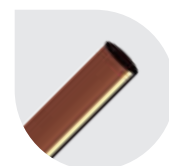

Copper pipe
W 24x19 - TR 91
G 3/4 EK - TR 91/A



Plastic pipe
W 24x19 - TP 95
G 3/4 EK - TP 98

MAIN BODY CONNECTION

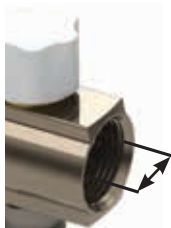

G 3/4
G 1"
G 1 1/4

CENTRE TO CENTRE DISTANCE

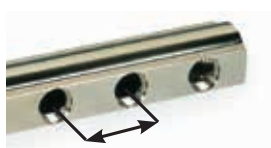

G 3/4 40 mm
G 1" 50 mm
G 1 1/4 50 mm



Multilayer pipe
W 24x19 - TP 97
G 3/4 EK - TP 98

FLOW REGULATORS AND HOLDERS



With regulators and flow meters TM 4012, adjusting and balancing manifolds allow for an immediate verification of the system's balance by reading the flow rate. This adjustment can be locked through a block cap. The glass and the measuring spring can be disassembled for maintenance and cleaned while the system is operating. This kind of manifold must be installed on the inlet.

LOCKSHIELD VALVE



Adjusting and balancing manifolds (lockshield type) feature a double micrometric adjustment with memory of position in case of temporary shutdowns and can be mounted both on inlets and outlets of the system.



CONVERTIBLE HEADWORK

The tightening device on the stem of the manifolds with built-in valves for thermo-electric adjustment can be inspected and replaced while the system is operating. The control stem is in AISI 316 stainless steel and its tightness is ensured by two peroxide cured EPDM o-rings.

All manifolds CD series are 100% tested with electronically controlled pneumatic seal test.

The characteristics of the fluid in the system must be compliant with the UNI 8065: 2019 directive.

DISTRIBUTION MANIFOLDS FOR HEATING SYSTEMS WITH INLET REGULATOR / FLOW METERS

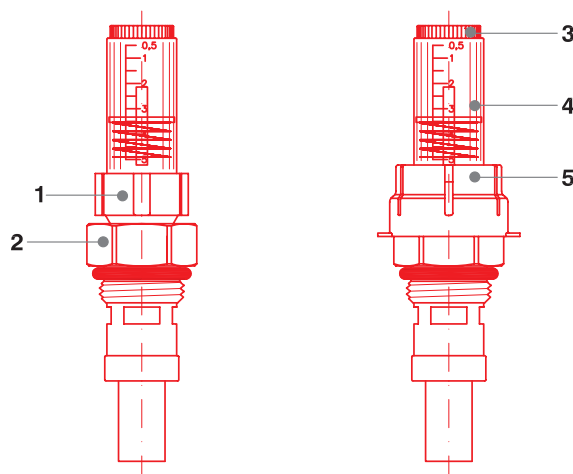

1. Adjusting collar
2. Fixing collar
3. Glass collar
4. Glass
5. Block cap

ADJUSTMENT INSTRUCTIONS FOR MANIFOLDS WITH INLET REGULATOR/FLOW METERS

BALANCING OF THE HYDRAULIC CIRCUITS

The theoretical flow rate of a hydraulic circuit, assigned by a technician, is given by the adjustment carried out through the regulator/flow meters TM 4012 (code 69000010) assembled on the flow inlet.

The adjustment must be carried out with the valve on the return circuit fully open.

Since the flow rates of each heating ring affect each other, each single heating ring has to be adjusted until the values in litres/minute laid down in the project are satisfactorily reached.

SECURING HYDRAULIC BALANCE AGAINST TAMPERING

The regulator/flow meters adjustment can be secured through a block cap.

If needed, the caps can be sealed with iron wire and lead.

CLEANING

The glass and the measuring spring can be disassembled for maintenance and cleaned. This can be done as follows even while the system is operating:

- close the top meter and the screw placed on the return manifold;
- unscrew the glass applying strength on the collar and take it out - be careful not to lose the measuring spring;
- during this operation, a negligible water leakage will appear;
- if necessary, the glass can now be easily cleaned;
- to reassemble, follow the above instructions in reverse.

PRESSURE DROP

The total pressure drop of the heating circuit is made up by various pressure drops: water return valve, pipes and regulator/flow meters.

DISTRIBUTION MANIFOLDS FOR HEATING SYSTEMS WITH BUILT-IN LOCKSHIELDS

ADJUSTMENT INSTRUCTIONS FOR MANIFOLDS WITH LOCKSHIELDS

Unscrew the plug (1). Screw the obturator with a hex key until it reaches the closed position.

After these operations the lockshield is ready to be set.

The relation between the Kv value, the position of the obturator and the corresponding curve, are described in the differential pressure diagram chart. This means that by unscrewing the obturator for a certain number of turns, it is possible to obtain the required Kv value.

EXAMPLE

- Curve n. 1: 1/2 turn of the screw - Kv 0,09
- Curve n. 3: 1+1/2 turn of the screw - Kv 0,76

Using the collar code 33466656 (supplied separately) it is possible to create a mechanical stop of the obturator.

Once the flow rate has been set through the obturator, the regulating collar must be screwed to the obturator.

It is now possible to open and close the obturator without losing the position of the previously set regulation.

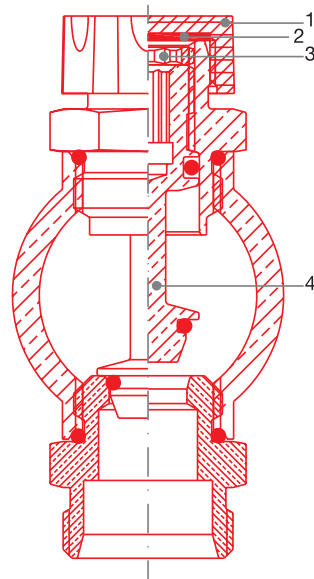

- 1. ABS plug
- 2. Gasket
- 3. Adjusting collar, code 3346656
- 4. Obturator

In case of water leakage from the screw stem, the sealing assembly can be tightened until the flow comes to a full stop. Should the leakage continue, the whole sealing assembly can be replaced by following the instructions below while the group is operating.

- Remove the protection cap, the knob, the thermostatic head or the thermoelectric head;
- Unscrew the sealing assembly with a 9mm key blocking the screw body with a 19mm key;
- Replace the part with article code 67980200 screwing it in with a 9mm key;
- Replace the protection cap, the knob, the thermostatic head or the thermoelectric head.

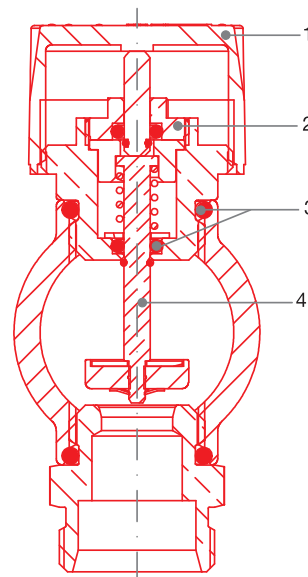

- 1. ABS plug or manual knob
- 2. Sealing assembly item 516
- 3. Gasket
- 4. Obturator

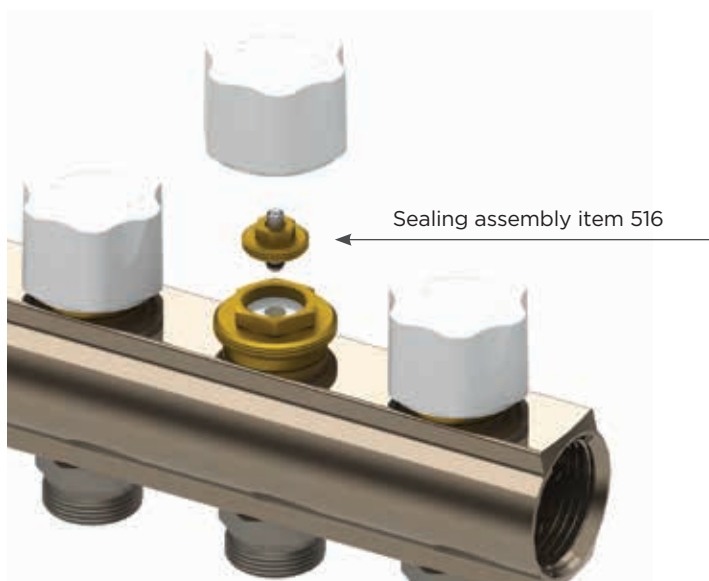

G 1"

HOW TO CHOOSE THE RIGHT CABINET

G 1" MANIFOLD

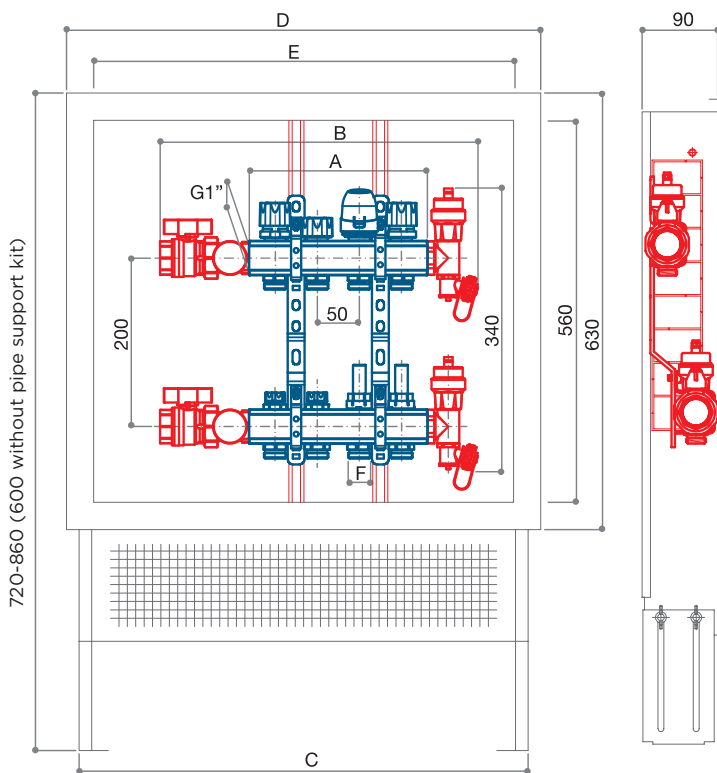

							CABINETS	
OUTLETS	A	B	C	D	E	F	ITEM	CODE
2	112	276	500	560	490	W24x19 - G 3/4 EK	CF 490	68561405
3	162	326						
4	212	376						
5	262	426	700	760	690		CF 490	68561407
6	312	476						
7	362	526						
8	412	576	850	910	840		CF 490	68561408
9	462	626						
10	512	676						
11	562	726	1000	1060	990		CF 490	68561410
12	612	776						
13	662	826						

G 1" MANIFOLD WITH DRAIN

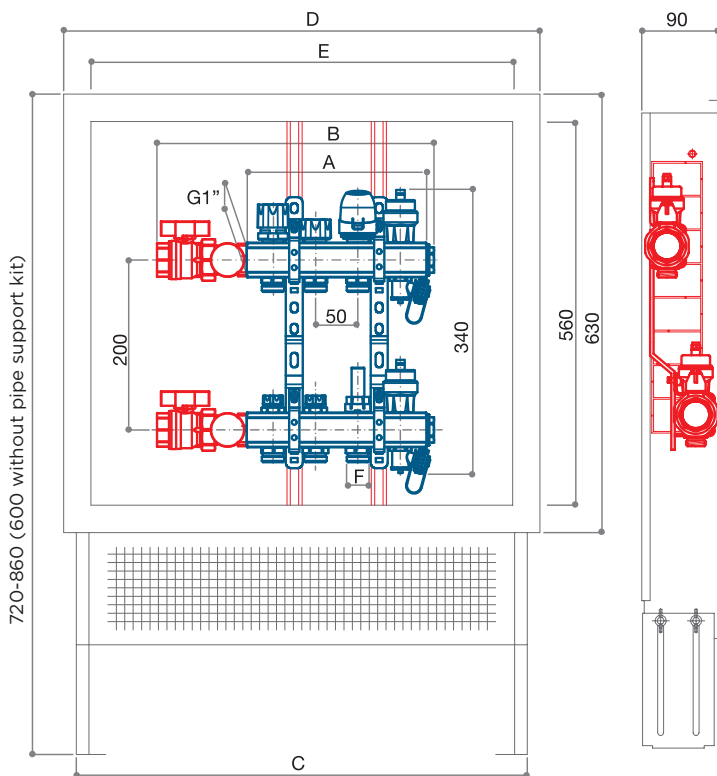

							CABINETS	
OUTLETS	A	B	C	D	E	F	ART.	CODE
2	162	276	500	560	490	W24x19 - G 3/4 EK	CF 490	68561405
3	212	326						
4	262	376						
5	312	426	700	760	690		CF 490	68561407
6	362	476						
7	412	526						
8	462	576	850	910	840		CF 490	68561408
9	512	626						
10	562	676						
11	612	726	776					
12	662							

G 1 1/4

HOW TO CHOOSE THE RIGHT CABINET

G 1 1/4 MANIFOLD

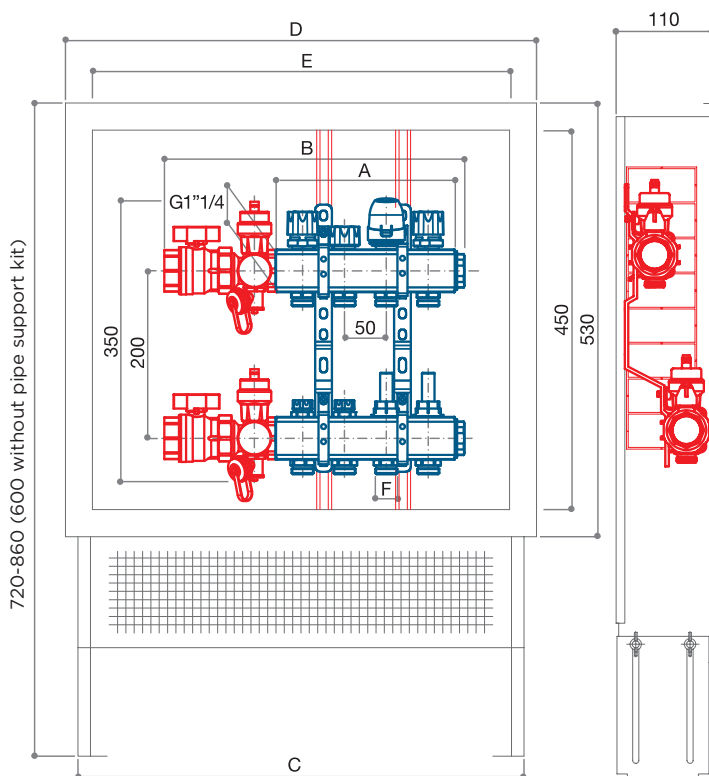

							CABINETS	
OUTLETS	A	B	C	D	E	F	ITEM	CODE
2	114	260	500	565	490	W24x19 - G 3/4 EK	CF 485	68560705
3	164	310						
4	214	360						
5	264	410	700	765	690		CF 485	68560707
6	314	460						
7	364	510						
8	414	560	850	915	840		CF 485	68560708
9	464	610						
10	514	660						
11	564	710	1000	1065	990		CF 485	68560710
12	614	760						
13	664	810						

G 1 1/4 MANIFOLD WITH DRAIN

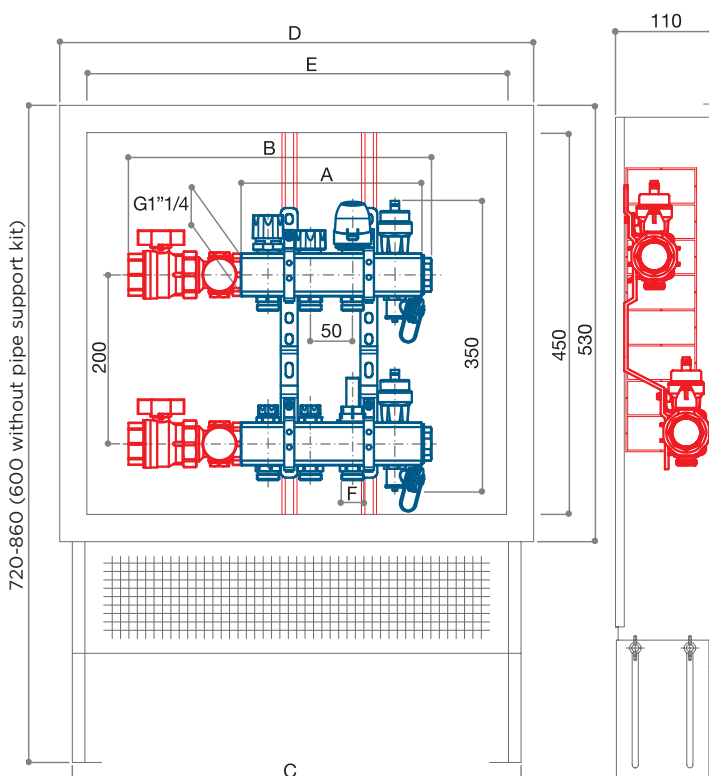

							CABINETS	
OUTLETS	A	B	C	D	E	F	ITEM	CODE
2	164	310	500	565	490	W24x19 - G 3/4 EK	CF 485	68560705
3	214	360						
4	264	410						
5	314	460	700	765	690		CF 485	68560707
6	364	510						
7	414	560						
8	464	610	850	915	840		CF 485	68560708
9	514	660						
10	564	710						
11	614	760	1000	1065	990		CF 485	68560710
12	664	810						

DISTRIBUTION MANIFOLDS FOR HEATING SYSTEMS

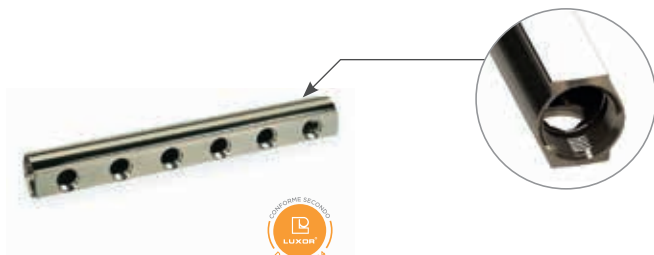

Distribution manifold.

CD 451
Interaxis
40 mm

yellow surface	nickel plated									
CODE	CODE	SIZE	OUTLETS N°							
17012102	17012102N	G 3/4 x G 1/2	2	-	-	-	0,298	-	60	
17012103	17012103N		3	-	-	-	0,448	-	40	
17012104	17012104N		4	-	-	-	0,596	-	30	
17012105	17012105N		5	-	-	-	0,746	-	25	
17012106	17012106N		6	-	-	-	0,894	-	25	
17012107	17012107N		7	-	-	-	1,044	-	20	
17012108	17012108N		8	-	-	-	1,192	-	20	
17012109	17012109N		9	-	-	-	1,342	-	20	
17012110	17012110N		10	-	-	-	1,490	-	15	

CD 456
Interaxis
50 mm

yellow surface	nickel plated									
CODE	CODE	SIZE	OUTLETS N°							
15012102	15012102N	G 1" x G 1/2	2	-	-	-	0,420	-	50	
15012103	15012103N		3	-	-	-	0,630	-	35	
15012104	15012104N		4	-	-	-	0,840	-	24	
15012105	15012105N		5	-	-	-	1,050	-	20	
15012106	15012106N		6	-	-	-	1,260	-	18	
15012107	15012107N		7	-	-	-	1,470	-	15	
15012108	15012108N		8	-	-	-	1,680	-	15	
15012109	15012109N		9	-	-	-	1,890	-	15	
15012110	15012110N		10	-	-	-	2,100	-	15	
15012111	15012111N		11	-	-	-	2,310	-	10	
15012112	15012112N		12	-	-	-	2,520	-	10	

CD 860
Interaxis
50 mm



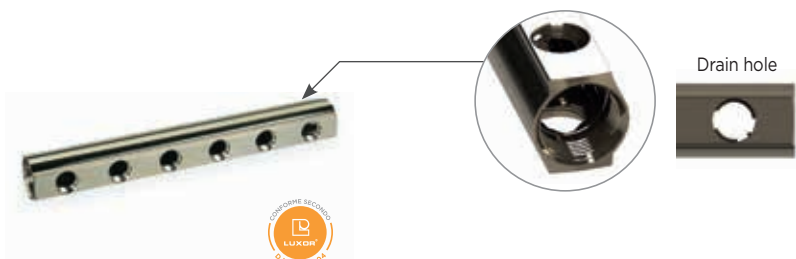



yellow surface	nickel plated									
CODE	CODE	SIZE	OUTLETS N°							
16012102	16012102N	G 1 1/4 x G 1/2	2	-	-	-	0,590	-	30	
16012103	16012103N		3	-	-	-	0,866	-	20	
16012104	16012104N		4	-	-	-	1,140	-	15	
16012105	16012105N		5	-	-	-	1,416	-	12	
16012106	16012106N		6	-	-	-	1,690	-	10	
16012107	16012107N		7	-	-	-	1,966	-	10	
16012108	16012108N		8	-	-	-	2,240	-	10	
16012109	16012109N		9	-	-	-	2,516	-	10	
16012110	16012110N		10	-	-	-	2,790	-	10	
16012111	16012111N		11	-	-	-	3,066	-	5	
16012112	16012112N		12	-	-	-	3,340	-	5	









Drain hole

Distribution manifold with 1/2 drain hole.

CD 457

yellow surface	nickel plated	SIZE	OUTLETS N°						
CODE	CODE								
15022102	15022102N	G 1" x G 1/2	2	-	-	-	0,420	-	50
15022103	15022103N		3	-	-	-	0,630	-	35
15022104	15022104N		4	-	-	-	0,840	-	24
15022105	15022105N		5	-	-	-	1,050	-	20
15022106	15022106N		6	-	-	-	1,260	-	18
15022107	15022107N		7	-	-	-	1,470	-	15
15022108	15022108N		8	-	-	-	1,700	-	15
15022109	15022109N		9	-	-	-	1,900	-	15
15022110	15022110N		10	-	-	-	2,110	-	15
15022111	15022111N		11	-	-	-	2,320	-	10
15022112	15022112N		12	-	-	-	2,510	-	10

CD 861

yellow surface	nickel plated	SIZE	OUTLETS N°						
CODE	CODE								
16022102	16022102N	G 1 1/4 x G 1/2	2	-	-	-	0,570	-	30
16022103	16022103N		3	-	-	-	0,860	-	20
16022104	16022104N		4	-	-	-	1,130	-	15
16022105	16022105N		5	-	-	-	1,390	-	12
16022106	16022106N		6	-	-	-	1,680	-	10
16022107	16022107N		7	-	-	-	1,940	-	10
16022108	16022108N		8	-	-	-	2,210	-	10
16022109	16022109N		9	-	-	-	2,470	-	10
16022110	16022110N		10	-	-	-	2,760	-	10
16022111	16022111N		11	-	-	-	3,040	-	5
16022112	16022112N		12	-	-	-	3,290	-	5



Distribution manifold with pre-assembled fittings article RD 900.



CD 459

yellow surface		nickel plated	SIZE	OUTLETS N°						
CODE	CODE	CODE								
15032402	15032402N	15032402N	G 1" x (W24x19)	2	TR 91	TP 95	TP 97	0,496	-	30
15032403	15032403N	15032403N		3	TR 91	TP 95	TP 97	0,744	-	20
15032404	15032404N	15032404N		4	TR 91	TP 95	TP 97	0,992	-	15
15032405	15032405N	15032405N		5	TR 91	TP 95	TP 97	1,240	-	12
15032406	15032406N	15032406N		6	TR 91	TP 95	TP 97	1,488	-	12
15032407	15032407N	15032407N		7	TR 91	TP 95	TP 97	1,736	-	10
15032408	15032408N	15032408N		8	TR 91	TP 95	TP 97	1,984	-	12
15032409	15032409N	15032409N		9	TR 91	TP 95	TP 97	2,232	-	10
15032410	15032410N	15032410N		10	TR 91	TP 95	TP 97	2,480	-	10
15032411	15032411N	15032411N		11	TR 91	TP 95	TP 97	2,728	-	10
15032412	15032412N	15032412N		12	TR 91	TP 95	TP 97	2,976	-	10

CD 461

yellow surface		nickel plated	SIZE	OUTLETS N°						
CODE	CODE	CODE								
15032702	15032702N	15032702N	G 1" x G 3/4 EK	2	TR 91/A	TP 98	TP 99	0,520	-	30
15032703	15032703N	15032703N		3	TR 91/A	TP 98	TP 99	0,780	-	20
15032704	15032704N	15032704N		4	TR 91/A	TP 98	TP 99	1,040	-	15
15032705	15032705N	15032705N		5	TR 91/A	TP 98	TP 99	1,300	-	12
15032706	15032706N	15032706N		6	TR 91/A	TP 98	TP 99	1,560	-	12
15032707	15032707N	15032707N		7	TR 91/A	TP 98	TP 99	1,820	-	10
15032708	15032708N	15032708N		8	TR 91/A	TP 98	TP 99	2,080	-	12
15032709	15032709N	15032709N		9	TR 91/A	TP 98	TP 99	2,340	-	10
15032710	15032710N	15032710N		10	TR 91/A	TP 98	TP 99	2,600	-	10
15032711	15032711N	15032711N		11	TR 91/A	TP 98	TP 99	2,860	-	10
15032712	15032712N	15032712N		12	TR 91/A	TP 98	TP 99	3,120	-	10

CD 862

yellow surface		nickel plated	SIZE	OUTLETS N°						
CODE	CODE	CODE								
16032402	16032402N	16032402N	G 1"1/4 x (W24x19)	2	TR 91	TP 95	TP 97	0,666	-	20
16032403	16032403N	16032403N		3	TR 91	TP 95	TP 97	0,980	-	12
16032404	16032404N	16032404N		4	TR 91	TP 95	TP 97	1,292	-	10
16032405	16032405N	16032405N		5	TR 91	TP 95	TP 97	1,606	-	10
16032406	16032406N	16032406N		6	TR 91	TP 95	TP 97	1,918	-	10
16032407	16032407N	16032407N		7	TR 91	TP 95	TP 97	2,232	-	10
16032408	16032408N	16032408N		8	TR 91	TP 95	TP 97	2,544	-	8
16032409	16032409N	16032409N		9	TR 91	TP 95	TP 97	2,858	-	8
16032410	16032410N	16032410N		10	TR 91	TP 95	TP 97	3,170	-	8
16032411	16032411N	16032411N		11	TR 91	TP 95	TP 97	3,484	-	8
16032412	16032412N	16032412N		12	TR 91	TP 95	TP 97	3,796	-	8





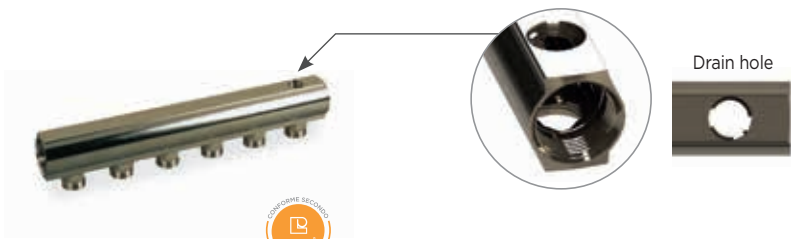

CD 864

yellow surface		nickel plated	SIZE	OUTLETS N°						
CODE	CODE	CODE								
16032702	16032702N	16032702N	G 1"1/4 x G 3/4 EK	2	TR 91/A	TP 98	TP 99	0,690	-	20
16032703	16032703N	16032703N		3	TR 91/A	TP 98	TP 99	1,019	-	12
16032704	16032704N	16032704N		4	TR 91/A	TP 98	TP 99	1,340	-	10
16032705	16032705N	16032705N		5	TR 91/A	TP 98	TP 99	1,666	-	10
16032706	16032706N	16032706N		6	TR 91/A	TP 98	TP 99	1,990	-	10
16032707	16032707N	16032707N		7	TR 91/A	TP 98	TP 99	2,316	-	10
16032708	16032708N	16032708N		8	TR 91/A	TP 98	TP 99	2,640	-	8
16032709	16032709N	16032709N		9	TR 91/A	TP 98	TP 99	2,966	-	8
16032710	16032710N	16032710N		10	TR 91/A	TP 98	TP 99	3,290	-	8
16032711	16032711N	16032711N		11	TR 91/A	TP 98	TP 99	3,616	-	8
16032712	16032712N	16032712N		12	TR 91/A	TP 98	TP 99	3,940	-	8









Distribution manifold with 1/2 drain hole and pre-assembled fittings article RD 900.







**CD 460**

yellow surface	nickel plated	SIZE	OUTLETS N°						
CODE	CODE								
15042402	15042402N	G 1" x (W24x19)	2	TR 91	TP 95	TP 97	0,486	-	30
15042403	15042403N		3	TR 91	TP 95	TP 97	0,734	-	20
15042404	15042404N		4	TR 91	TP 95	TP 97	0,982	-	15
15042405	15042405N		5	TR 91	TP 95	TP 97	1,230	-	12
15042406	15042406N		6	TR 91	TP 95	TP 97	1,478	-	12
15042407	15042407N		7	TR 91	TP 95	TP 97	1,726	-	10
15042408	15042408N		8	TR 91	TP 95	TP 97	1,974	-	12
15042409	15042409N		9	TR 91	TP 95	TP 97	2,222	-	10
15042410	15042410N		10	TR 91	TP 95	TP 97	2,470	-	10
15042411	15042411N		11	TR 91	TP 95	TP 97	2,718	-	10
15042412	15042412N		12	TR 91	TP 95	TP 97	2,966	-	10







CD 462

yellow surface	nickel plated	SIZE	OUTLETS N°						
CODE	CODE								
15042702	15042702N	G 1" x G 3/4 EK	2	TR 91/A	TP 98	TP 99	0,510	-	30
15042703	15042703N		3	TR 91/A	TP 98	TP 99	0,770	-	20
15042704	15042704N		4	TR 91/A	TP 98	TP 99	1,030	-	15
15042705	15042705N		5	TR 91/A	TP 98	TP 99	1,290	-	12
15042706	15042706N		6	TR 91/A	TP 98	TP 99	1,550	-	12
15042707	15042707N		7	TR 91/A	TP 98	TP 99	1,810	-	10
15042708	15042708N		8	TR 91/A	TP 98	TP 99	2,070	-	12
15042709	15042709N		9	TR 91/A	TP 98	TP 99	2,330	-	10
15042710	15042710N		10	TR 91/A	TP 98	TP 99	2,590	-	10
15042711	15042711N		11	TR 91/A	TP 98	TP 99	2,850	-	10
15042712	15042712N		12	TR 91/A	TP 98	TP 99	3,110	-	10

CD 863

yellow surface	nickel plated	SIZE	OUTLETS N°						
CODE	CODE								
16042402	16042402N	G 1 1/4 x (W24x19)	2	TR 91	TP 95	TP 97	0,656	-	20
16042403	16042403N		3	TR 91	TP 95	TP 97	0,970	-	12
16042404	16042404N		4	TR 91	TP 95	TP 97	1,282	-	10
16042405	16042405N		5	TR 91	TP 95	TP 97	1,596	-	10
16042406	16042406N		6	TR 91	TP 95	TP 97	1,908	-	10
16042407	16042407N		7	TR 91	TP 95	TP 97	2,222	-	10
16042408	16042408N		8	TR 91	TP 95	TP 97	2,534	-	8
16042409	16042409N		9	TR 91	TP 95	TP 97	2,848	-	8
16042410	16042410N		10	TR 91	TP 95	TP 97	3,160	-	8
16042411	16042411N		11	TR 91	TP 95	TP 97	3,474	-	8
16042412	16042412N		12	TR 91	TP 95	TP 97	3,786	-	8

CD 865

yellow surface	nickel plated	SIZE	OUTLETS N°						
CODE	CODE								
16042702	16042702N	G 1 1/4 x G 3/4 EK	2	TR 91/A	TP 98	TP 99	0,680	-	20
16042703	16042703N		3	TR 91/A	TP 98	TP 99	1,009	-	12
16042704	16042704N		4	TR 91/A	TP 98	TP 99	1,330	-	10
16042705	16042705N		5	TR 91/A	TP 98	TP 99	1,656	-	10
16042706	16042706N		6	TR 91/A	TP 98	TP 99	1,980	-	10
16042707	16042707N		7	TR 91/A	TP 98	TP 99	2,306	-	10
16042708	16042708N		8	TR 91/A	TP 98	TP 99	2,630	-	8
16042709	16042709N		9	TR 91/A	TP 98	TP 99	2,956	-	8
16042710	16042710N		10	TR 91/A	TP 98	TP 99	3,280	-	8
16042711	16042711N		11	TR 91/A	TP 98	TP 99	3,606	-	8
16042712	16042712N		12	TR 91/A	TP 98	TP 99	3,930	-	8



Pre-assembled distribution manifold with built-in valves set for thermoelectric adjustment and protection caps.

CD 1466

yellow surface	nickel plated	SIZE	OUTLETS N°						
CODE	CODE								
15112402	15112402N	G 1" x (W24x19)	2	TR 91	TP 95	TP 97	0,644	-	20
15112403	15112403N		3	TR 91	TP 95	TP 97	0,956	-	15
15112404	15112404N		4	TR 91	TP 95	TP 97	1,268	-	12
15112405	15112405N		5	TR 91	TP 95	TP 97	1,580	-	10
15112406	15112406N		6	TR 91	TP 95	TP 97	1,892	-	9
15112407	15112407N		7	TR 91	TP 95	TP 97	2,204	-	8
15112408	15112408N		8	TR 91	TP 95	TP 97	2,516	-	8
15112409	15112409N		9	TR 91	TP 95	TP 97	2,828	-	8
15112410	15112410N		10	TR 91	TP 95	TP 97	3,140	-	8
15112411	15112411N		11	TR 91	TP 95	TP 97	3,452	-	8
15112412	15112412N		12	TR 91	TP 95	TP 97	3,764	-	8

CD 1446

yellow surface	nickel plated	SIZE	OUTLETS N°						
CODE	CODE								
15112702	15112702N	G 1" x G 3/4 EK	2	TR 91/A	TP 98	TP 99	0,664	-	20
15112703	15112703N		3	TR 91/A	TP 98	TP 99	0,986	-	15
15112704	15112704N		4	TR 91/A	TP 98	TP 99	1,308	-	12
15112705	15112705N		5	TR 91/A	TP 98	TP 99	1,630	-	10
15112706	15112706N		6	TR 91/A	TP 98	TP 99	1,952	-	10
15112707	15112707N		7	TR 91/A	TP 98	TP 99	2,274	-	8
15112708	15112708N		8	TR 91/A	TP 98	TP 99	2,596	-	8
15112709	15112709N		9	TR 91/A	TP 98	TP 99	2,918	-	8
15112710	15112710N		10	TR 91/A	TP 98	TP 99	3,240	-	8
15112711	15112711N		11	TR 91/A	TP 98	TP 99	3,562	-	8
15112712	15112712N		12	TR 91/A	TP 98	TP 99	3,884	-	8

CD 875

yellow surface	nickel plated	SIZE	OUTLETS N°						
CODE	CODE								
16112402	16112402N	G 1"1/4 x (W24x19)	2	TR 91	TP 95	TP 97	0,794	-	15
16112403	16112403N		3	TR 91	TP 95	TP 97	1,166	-	12
16112404	16112404N		4	TR 91	TP 95	TP 97	1,538	-	10
16112405	16112405N		5	TR 91	TP 95	TP 97	1,960	-	8
16112406	16112406N		6	TR 91	TP 95	TP 97	2,282	-	8
16112407	16112407N		7	TR 91	TP 95	TP 97	2,654	-	8
16112408	16112408N		8	TR 91	TP 95	TP 97	3,026	-	6
16112409	16112409N		9	TR 91	TP 95	TP 97	3,398	-	6
16112410	16112410N		10	TR 91	TP 95	TP 97	3,770	-	6
16112411	16112411N		11	TR 91	TP 95	TP 97	4,142	-	6
16112412	16112412N		12	TR 91	TP 95	TP 97	4,514	-	6

CD 876

yellow surface	nickel plated	SIZE	OUTLETS N°						
CODE	CODE								
16112702	16112702N	G 1"1/4 x G 3/4 EK	2	TR 91/A	TP 98	TP 99	0,814	-	15
16112703	16112703N		3	TR 91/A	TP 98	TP 99	1,196	-	12
16112704	16112704N		4	TR 91/A	TP 98	TP 99	1,578	-	10
16112705	16112705N		5	TR 91/A	TP 98	TP 99	1,960	-	8
16112706	16112706N		6	TR 91/A	TP 98	TP 99	2,342	-	8
16112707	16112707N		7	TR 91/A	TP 98	TP 99	2,724	-	8
16112708	16112708N		8	TR 91/A	TP 98	TP 99	3,106	-	6
16112709	16112709N		9	TR 91/A	TP 98	TP 99	3,488	-	6
16112710	16112710N		10	TR 91/A	TP 98	TP 99	3,870	-	6
16112711	16112711N		11	TR 91/A	TP 98	TP 99	4,252	-	6
16112712	16112712N		12	TR 91/A	TP 98	TP 99	4,634	-	6



Fittings for copper pipe



Fittings for plastic pipe



Fittings for multilayer pipe



Fittings: chapter 7



Accessories: chapter 2.A

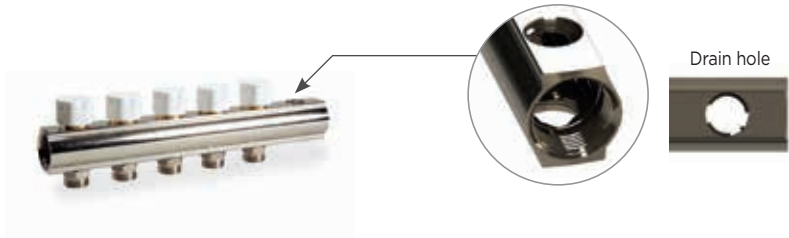

Pre-assembled distribution manifold with two 1/2 drain holes and built-in valves set for thermoelectric adjustment and protection caps.

CD 3466

yellow surface	nickel plated	SIZE	OUTLETS N°						
CODE	CODE								
15122402	15122402N	G 1" x (W24x19)	2	TR 91	TP 95	TP 97	0,834	-	15
15122403	15122403N		3	TR 91	TP 95	TP 97	1,146	-	12
15122404	15122404N		4	TR 91	TP 95	TP 97	1,458	-	10
15122405	15122405N		5	TR 91	TP 95	TP 97	1,770	-	9
15122406	15122406N		6	TR 91	TP 95	TP 97	2,082	-	8
15122407	15122407N		7	TR 91	TP 95	TP 97	2,394	-	8
15122408	15122408N		8	TR 91	TP 95	TP 97	2,706	-	8
15122409	15122409N		9	TR 91	TP 95	TP 97	3,018	-	8
15122410	15122410N		10	TR 91	TP 95	TP 97	3,330	-	8
15122411	15122411N		11	TR 91	TP 95	TP 97	3,642	-	8
15122412	15122412N		12	TR 91	TP 95	TP 97	3,954	-	8

CD 3446

yellow surface	nickel plated	SIZE	OUTLETS N°						
CODE	CODE								
15122702	15122702N	G 1" x G 3/4 EK	2	TR 91/A	TP 98	TP 99	0,854	-	15
15122703	15122703N		3	TR 91/A	TP 98	TP 99	1,176	-	12
15122704	15122704N		4	TR 91/A	TP 98	TP 99	1,498	-	10
15122705	15122705N		5	TR 91/A	TP 98	TP 99	1,820	-	9
15122706	15122706N		6	TR 91/A	TP 98	TP 99	2,142	-	8
15122707	15122707N		7	TR 91/A	TP 98	TP 99	2,464	-	8
15122708	15122708N		8	TR 91/A	TP 98	TP 99	2,786	-	8
15122709	15122709N		9	TR 91/A	TP 98	TP 99	3,108	-	8
15122710	15122710N		10	TR 91/A	TP 98	TP 99	3,430	-	8
15122711	15122711N		11	TR 91/A	TP 98	TP 99	3,752	-	8
15122712	15122712N		12	TR 91/A	TP 98	TP 99	4,074	-	8

CD 877

yellow surface	nickel plated	SIZE	OUTLETS N°						
CODE	CODE								
16122402	16122402N	G 1 1/4 x (W24x19)	2	TR 91	TP 95	TP 97	1,044	-	12
16122403	16122403N		3	TR 91	TP 95	TP 97	1,416	-	10
16122404	16122404N		4	TR 91	TP 95	TP 97	1,788	-	8
16122405	16122405N		5	TR 91	TP 95	TP 97	2,160	-	8
16122406	16122406N		6	TR 91	TP 95	TP 97	2,532	-	6
16122407	16122407N		7	TR 91	TP 95	TP 97	2,904	-	6
16122408	16122408N		8	TR 91	TP 95	TP 97	3,276	-	6
16122409	16122409N		9	TR 91	TP 95	TP 97	3,648	-	6
16122410	16122410N		10	TR 91	TP 95	TP 97	4,020	-	6
16122411	16122411N		11	TR 91	TP 95	TP 97	4,392	-	6
16122412	16122412N		12	TR 91	TP 95	TP 97	4,764	-	6

CD 878

yellow surface	nickel plated	SIZE	OUTLETS N°						
CODE	CODE								
16122702	16122702N	G 1 1/4 x G 3/4 EK	2	TR 91/A	TP 98	TP 99	1,064	-	12
16122703	16122703N		3	TR 91/A	TP 98	TP 99	1,446	-	10
16122704	16122704N		4	TR 91/A	TP 98	TP 99	1,828	-	8
16122705	16122705N		5	TR 91/A	TP 98	TP 99	2,210	-	8
16122706	16122706N		6	TR 91/A	TP 98	TP 99	2,592	-	6
16122707	16122707N		7	TR 91/A	TP 98	TP 99	2,974	-	6
16122708	16122708N		8	TR 91/A	TP 98	TP 99	3,356	-	6
16122709	16122709N		9	TR 91/A	TP 98	TP 99	3,738	-	6
16122710	16122710N		10	TR 91/A	TP 98	TP 99	4,120	-	6
16122711	16122711N		11	TR 91/A	TP 98	TP 99	4,502	-	6
16122712	16122712N		12	TR 91/A	TP 98	TP 99	4,884	-	6



Pre-assembled distribution manifold with built-in valves set for thermoelectric adjustment and manual control knob.

CD 466

yellow surface	nickel plated								
CODE	CODE	SIZE	OUTLETS N°						
15152402	15152402N	G 1" x (W24x19)	2	TR 91	TP 95	TP 97	0,664	-	10
15152403	15152403N		3	TR 91	TP 95	TP 97	0,986	-	10
15152404	15152404N		4	TR 91	TP 95	TP 97	1,308	-	8
15152405	15152405N		5	TR 91	TP 95	TP 97	1,630	-	8
15152406	15152406N		6	TR 91	TP 95	TP 97	1,952	-	6
15152407	15152407N		7	TR 91	TP 95	TP 97	2,274	-	6
15152408	15152408N		8	TR 91	TP 95	TP 97	2,596	-	6
15152409	15152409N		9	TR 91	TP 95	TP 97	2,918	-	6
15152410	15152410N		10	TR 91	TP 95	TP 97	3,240	-	6
15152411	15152411N		11	TR 91	TP 95	TP 97	3,562	-	6
15152412	15152412N		12	TR 91	TP 95	TP 97	3,884	-	6

CD 446

yellow surface	nickel plated								
CODE	CODE	SIZE	OUTLETS N°						
15152702	15152702N	G 1" x G 3/4 EK	2	TR 91/A	TP 98	TP 99	0,684	-	10
15152703	15152703N		3	TR 91/A	TP 98	TP 99	1,016	-	10
15152704	15152704N		4	TR 91/A	TP 98	TP 99	1,348	-	8
15152705	15152705N		5	TR 91/A	TP 98	TP 99	1,680	-	8
15152706	15152706N		6	TR 91/A	TP 98	TP 99	2,012	-	6
15152707	15152707N		7	TR 91/A	TP 98	TP 99	2,344	-	6
15152708	15152708N		8	TR 91/A	TP 98	TP 99	2,676	-	6
15152709	15152709N		9	TR 91/A	TP 98	TP 99	3,008	-	6
15152710	15152710N		10	TR 91/A	TP 98	TP 99	3,340	-	6
15152711	15152711N		11	TR 91/A	TP 98	TP 99	3,672	-	6
15152712	15152712N		12	TR 91/A	TP 98	TP 99	4,004	-	6

CD 871

yellow surface	nickel plated								
CODE	CODE	SIZE	OUTLETS N°						
16152402	16152402N	G 1 1/4 x (W24x19)	2	TR 91	TP 95	TP 97	0,814	-	8
16152403	16152403N		3	TR 91	TP 95	TP 97	1,196	-	8
16152404	16152404N		4	TR 91	TP 95	TP 97	1,578	-	6
16152405	16152405N		5	TR 91	TP 95	TP 97	1,960	-	6
16152406	16152406N		6	TR 91	TP 95	TP 97	2,342	-	4
16152407	16152407N		7	TR 91	TP 95	TP 97	2,724	-	4
16152408	16152408N		8	TR 91	TP 95	TP 97	3,106	-	4
16152409	16152409N		9	TR 91	TP 95	TP 97	3,488	-	4
16152410	16152410N		10	TR 91	TP 95	TP 97	3,870	-	4
16152411	16152411N		11	TR 91	TP 95	TP 97	4,252	-	4
16152412	16152412N		12	TR 91	TP 95	TP 97	4,634	-	4

CD 872

yellow surface	nickel plated								
CODE	CODE	SIZE	OUTLETS N°						
16152702	16152702N	G 1 1/4 x G 3/4 EK	2	TR 91/A	TP 98	TP 99	0,834	-	8
16152703	16152703N		3	TR 91/A	TP 98	TP 99	1,226	-	8
16152704	16152704N		4	TR 91/A	TP 98	TP 99	1,618	-	6
16152705	16152705N		5	TR 91/A	TP 98	TP 99	2,010	-	6
16152706	16152706N		6	TR 91/A	TP 98	TP 99	2,402	-	4
16152707	16152707N		7	TR 91/A	TP 98	TP 99	2,794	-	4
16152708	16152708N		8	TR 91/A	TP 98	TP 99	3,186	-	4
16152709	16152709N		9	TR 91/A	TP 98	TP 99	3,578	-	4
16152710	16152710N		10	TR 91/A	TP 98	TP 99	3,970	-	4
16152711	16152711N		11	TR 91/A	TP 98	TP 99	4,362	-	4
16152712	16152712N		12	TR 91/A	TP 98	TP 99	4,754	-	4



Fittings for copper pipe



Fittings for plastic pipe



Fittings for multilayer pipe



Fittings: chapter 7



Accessories: chapter 2.A

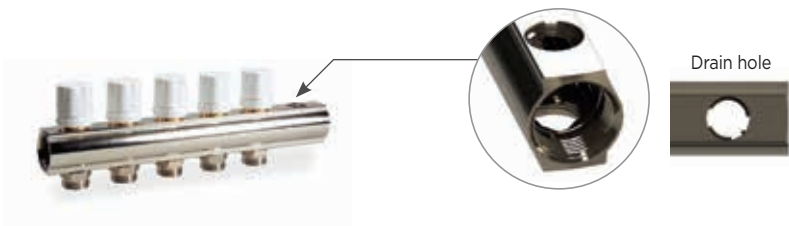

Pre-assembled distribution manifold with two 1/2 drain holes and built-in valves set for thermoelectric adjustment and manual control knob.

CD 2466

yellow surface	nickel plated	CODE	SIZE	OUTLETS N°	TR 91	TP 95	TP 97	kg	box	box
CODE	CODE									
15162402	15162402N	G 1" x (W24x19)	2	TR 91	TP 95	TP 97	0,854	-	10	
15162403	15162403N		3	TR 91	TP 95	TP 97	1,176	-	8	
15162404	15162404N		4	TR 91	TP 95	TP 97	1,498	-	8	
15162405	15162405N		5	TR 91	TP 95	TP 97	1,820	-	6	
15162406	15162406N		6	TR 91	TP 95	TP 97	2,142	-	6	
15162407	15162407N		7	TR 91	TP 95	TP 97	2,464	-	6	
15162408	15162408N		8	TR 91	TP 95	TP 97	2,785	-	6	
15162409	15162409N		9	TR 91	TP 95	TP 97	3,108	-	6	
15162410	15162410N		10	TR 91	TP 95	TP 97	3,430	-	6	
15162411	15162411N		11	TR 91	TP 95	TP 97	3,752	-	6	
15162412	15162412N		12	TR 91	TP 95	TP 97	4,074	-	6	

CD 2446

yellow surface	nickel plated	CODE	SIZE	OUTLETS N°	TR 91/A	TP 98	TP 99	kg	box	box
CODE	CODE									
15162702	15162702N	G 1" x G 3/4 EK	2	TR 91/A	TP 98	TP 99	0,874	-	10	
15162703	15162703N		3	TR 91/A	TP 98	TP 99	1,206	-	8	
15162704	15162704N		4	TR 91/A	TP 98	TP 99	1,538	-	8	
15162705	15162705N		5	TR 91/A	TP 98	TP 99	1,870	-	6	
15162706	15162706N		6	TR 91/A	TP 98	TP 99	2,202	-	6	
15162707	15162707N		7	TR 91/A	TP 98	TP 99	2,534	-	6	
15162708	15162708N		8	TR 91/A	TP 98	TP 99	2,866	-	6	
15162709	15162709N		9	TR 91/A	TP 98	TP 99	3,198	-	6	
15162710	15162710N		10	TR 91/A	TP 98	TP 99	3,530	-	6	
15162711	15162711N		11	TR 91/A	TP 98	TP 99	3,862	-	6	
15162712	15162712N		12	TR 91/A	TP 98	TP 99	4,194	-	6	

CD 873

yellow surface	nickel plated	CODE	SIZE	OUTLETS N°	TR 91	TP 95	TP 97	kg	box	box
CODE	CODE									
16162402	16162402N	G 1 1/4 x (W24x19)	2	TR 91	TP 95	TP 97	1,064	-	8	
16162403	16162403N		3	TR 91	TP 95	TP 97	1,446	-	6	
16162404	16162404N		4	TR 91	TP 95	TP 97	1,828	-	6	
16162405	16162405N		5	TR 91	TP 95	TP 97	2,210	-	6	
16162406	16162406N		6	TR 91	TP 95	TP 97	2,592	-	6	
16162407	16162407N		7	TR 91	TP 95	TP 97	2,974	-	6	
16162408	16162408N		8	TR 91	TP 95	TP 97	3,356	-	6	
16162409	16162409N		9	TR 91	TP 95	TP 97	3,738	-	6	
16162410	16162410N		10	TR 91	TP 95	TP 97	4,120	-	6	
16162411	16162411N		11	TR 91	TP 95	TP 97	4,502	-	6	
16162412	16162412N		12	TR 91	TP 95	TP 97	4,884	-	6	

CD 874

yellow surface	nickel plated	CODE	SIZE	OUTLETS N°	TR 91/A	TP 98	TP 99	kg	box	box
CODE	CODE									
16162702	16162702N	G 1 1/4 x G 3/4 EK	2	TR 91/A	TP 98	TP 99	1,084	-	8	
16162703	16162703N		3	TR 91/A	TP 98	TP 99	1,476	-	6	
16162704	16162704N		4	TR 91/A	TP 98	TP 99	1,868	-	6	
16162705	16162705N		5	TR 91/A	TP 98	TP 99	2,260	-	6	
16162706	16162706N		6	TR 91/A	TP 98	TP 99	2,652	-	6	
16162707	16162707N		7	TR 91/A	TP 98	TP 99	3,044	-	6	
16162708	16162708N		8	TR 91/A	TP 98	TP 99	3,436	-	6	
16162709	16162709N		9	TR 91/A	TP 98	TP 99	3,828	-	6	
16162710	16162710N		10	TR 91/A	TP 98	TP 99	4,220	-	6	
16162711	16162711N		11	TR 91/A	TP 98	TP 99	4,612	-	6	
16162712	16162712N		12	TR 91/A	TP 98	TP 99	5,004	-	6	



Pre-assembled distribution manifold with built in lockshields fit for double regulation.

CD 449

yellow surface	nickel plated								
CODE	CODE	SIZE	OUTLETS N°						
15212402	15212402N	G 1" x (W24x19)	2	TR 91	TP 95	TP 97	0,620	-	25
15212403	15212403N		3	TR 91	TP 95	TP 97	0,920	-	20
15212404	15212404N		4	TR 91	TP 95	TP 97	1,220	-	15
15212405	15212405N		5	TR 91	TP 95	TP 97	1,520	-	15
15212406	15212406N		6	TR 91	TP 95	TP 97	1,820	-	10
15212407	15212407N		7	TR 91	TP 95	TP 97	2,120	-	10
15212408	15212408N		8	TR 91	TP 95	TP 97	2,420	-	10
15212409	15212409N		9	TR 91	TP 95	TP 97	2,720	-	10
15212410	15212410N		10	TR 91	TP 95	TP 97	3,020	-	10
15212411	15212411N		11	TR 91	TP 95	TP 97	3,320	-	10
15212412	15212412N		12	TR 91	TP 95	TP 97	3,620	-	10

CD 448

yellow surface	nickel plated								
CODE	CODE	SIZE	OUTLETS N°						
15212702	15212702N	G 1" x G 3/4 EK	2	TR 91/A	TP 98	TP 99	0,640	-	25
15212703	15212703N		3	TR 91/A	TP 98	TP 99	0,950	-	20
15212704	15212704N		4	TR 91/A	TP 98	TP 99	1,260	-	15
15212705	15212705N		5	TR 91/A	TP 98	TP 99	1,570	-	15
15212706	15212706N		6	TR 91/A	TP 98	TP 99	1,880	-	10
15212707	15212707N		7	TR 91/A	TP 98	TP 99	2,190	-	10
15212708	15212708N		8	TR 91/A	TP 98	TP 99	2,500	-	10
15212709	15212709N		9	TR 91/A	TP 98	TP 99	2,810	-	10
15212710	15212710N		10	TR 91/A	TP 98	TP 99	3,120	-	10
15212711	15212711N		11	TR 91/A	TP 98	TP 99	3,430	-	10
15212712	15212712N		12	TR 91/A	TP 98	TP 99	3,740	-	10

CD 879

yellow surface	nickel plated								
CODE	CODE	SIZE	OUTLETS N°						
16212402	16212402N	G 1"1/4 x (W24x19)	2	TR 91	TP 95	TP 97	0,770	-	15
16212403	16212403N		3	TR 91	TP 95	TP 97	1,130	-	12
16212404	16212404N		4	TR 91	TP 95	TP 97	1,490	-	10
16212405	16212405N		5	TR 91	TP 95	TP 97	1,850	-	10
16212406	16212406N		6	TR 91	TP 95	TP 97	2,210	-	8
16212407	16212407N		7	TR 91	TP 95	TP 97	2,570	-	8
16212408	16212408N		8	TR 91	TP 95	TP 97	2,930	-	8
16212409	16212409N		9	TR 91	TP 95	TP 97	3,290	-	8
16212410	16212410N		10	TR 91	TP 95	TP 97	3,650	-	8
16212411	16212411N		11	TR 91	TP 95	TP 97	4,010	-	8
16212412	16212412N		12	TR 91	TP 95	TP 97	4,370	-	8

CD 880





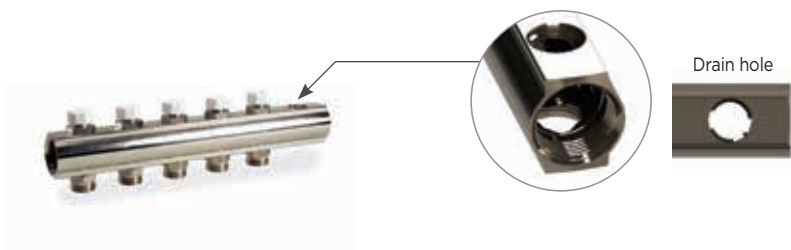

yellow surface	nickel plated								
CODE	CODE	SIZE	OUTLETS N°						
16212702	16212702N	G 1"1/4 x G 3/4 EK	2	TR 91/A	TP 98	TP 99	0,790	-	15
16212703	16212703N		3	TR 91/A	TP 98	TP 99	1,160	-	12
16212704	16212704N		4	TR 91/A	TP 98	TP 99	1,530	-	10
16212705	16212705N		5	TR 91/A	TP 98	TP 99	1,900	-	10
16212706	16212706N		6	TR 91/A	TP 98	TP 99	2,270	-	8
16212707	16212707N		7	TR 91/A	TP 98	TP 99	2,640	-	8
16212708	16212708N		8	TR 91/A	TP 98	TP 99	3,010	-	8
16212709	16212709N		9	TR 91/A	TP 98	TP 99	3,380	-	8
16212710	16212710N		10	TR 91/A	TP 98	TP 99	3,750	-	8
16212711	16212711N		11	TR 91/A	TP 98	TP 99	4,120	-	8
16212712	16212712N		12	TR 91/A	TP 98	TP 99	4,490	-	8











Pre-assembled distribution manifold with 2 1/2" drain holes, with built in lockshields fit for double regulation.







CD 1449

yellow surface	nickel plated	SIZE	OUTLETS N°						
CODE	CODE								
15222402	15222402N	G 1" x (W24x19)	2	TR 91	TP 95	TP 97	0,810	-	20
15222403	15222403N		3	TR 91	TP 95	TP 97	1,110	-	15
15222404	15222404N		4	TR 91	TP 95	TP 97	1,410	-	15
15222405	15222405N		5	TR 91	TP 95	TP 97	1,710	-	10
15222406	15222406N		6	TR 91	TP 95	TP 97	2,010	-	10
15222407	15222407N		7	TR 91	TP 95	TP 97	2,310	-	10
15222408	15222408N		8	TR 91	TP 95	TP 97	2,610	-	10
15222409	15222409N		9	TR 91	TP 95	TP 97	2,910	-	10
15222410	15222410N		10	TR 91	TP 95	TP 97	3,210	-	10
15222411	15222411N		11	TR 91	TP 95	TP 97	3,510	-	10
15222412	15222412N		12	TR 91	TP 95	TP 97	3,810	-	10







CD 1448

yellow surface	nickel plated	SIZE	OUTLETS N°						
CODE	CODE								
15222702	15222702N	G 1" x G 3/4 EK	2	TR 91/A	TP 98	TP 99	0,830	-	20
15222703	15222703N		3	TR 91/A	TP 98	TP 99	1,140	-	15
15222704	15222704N		4	TR 91/A	TP 98	TP 99	1,450	-	15
15222705	15222705N		5	TR 91/A	TP 98	TP 99	1,760	-	10
15222706	15222706N		6	TR 91/A	TP 98	TP 99	2,070	-	10
15222707	15222707N		7	TR 91/A	TP 98	TP 99	2,380	-	10
15222708	15222708N		8	TR 91/A	TP 98	TP 99	2,690	-	10
15222709	15222709N		9	TR 91/A	TP 98	TP 99	3,000	-	10
15222710	15222710N		10	TR 91/A	TP 98	TP 99	3,310	-	10
15222711	15222711N		11	TR 91/A	TP 98	TP 99	3,620	-	10
15222712	15222712N		12	TR 91/A	TP 98	TP 99	3,930	-	10

CD 881

yellow surface	nickel plated	SIZE	OUTLETS N°						
CODE	CODE								
16222402	16222402N	G 1 1/4 x (W24x19)	2	TR 91	TP 95	TP 97	1,020	-	12
16222403	16222403N		3	TR 91	TP 95	TP 97	1,380	-	10
16222404	16222404N		4	TR 91	TP 95	TP 97	1,740	-	10
16222405	16222405N		5	TR 91	TP 95	TP 97	2,100	-	8
16222406	16222406N		6	TR 91	TP 95	TP 97	2,460	-	8
16222407	16222407N		7	TR 91	TP 95	TP 97	2,820	-	6
16222408	16222408N		8	TR 91	TP 95	TP 97	3,180	-	6
16222409	16222409N		9	TR 91	TP 95	TP 97	3,540	-	6
16222410	16222410N		10	TR 91	TP 95	TP 97	3,900	-	6
16222411	16222411N		11	TR 91	TP 95	TP 97	4,260	-	6
16222412	16222412N		12	TR 91	TP 95	TP 97	4,620	-	6

CD 882

yellow surface	nickel plated	SIZE	OUTLETS N°						
CODE	CODE								
16222702	16222702N	G 1 1/4 x G 3/4 EK	2	TR 91/A	TP 98	TP 99	1,040	-	12
16222703	16222703N		3	TR 91/A	TP 98	TP 99	1,410	-	10
16222704	16222704N		4	TR 91/A	TP 98	TP 99	1,780	-	10
16222705	16222705N		5	TR 91/A	TP 98	TP 99	2,150	-	8
16222706	16222706N		6	TR 91/A	TP 98	TP 99	2,520	-	8
16222707	16222707N		7	TR 91/A	TP 98	TP 99	2,890	-	6
16222708	16222708N		8	TR 91/A	TP 98	TP 99	3,260	-	6
16222709	16222709N		9	TR 91/A	TP 98	TP 99	3,630	-	6
16222710	16222710N		10	TR 91/A	TP 98	TP 99	4,000	-	6
16222711	16222711N		11	TR 91/A	TP 98	TP 99	4,370	-	6
16222712	16222712N		12	TR 91/A	TP 98	TP 99	4,740	-	6





Pre-assembled distribution manifold with regulator/flow meters.

CD 1474

yellow surface	nickel plated	CODE	CODE	SIZE	OUTLETS N°						
		15252402	15252402N	G 1" x (W24x19)	2	TR 91	TP 95	TP 97	0,678	-	18
		15252403	15252403N		3	TR 91	TP 95	TP 97	0,992	-	12
		15252404	15252404N		4	TR 91	TP 95	TP 97	1,316	-	7
		15252405	15252405N		5	TR 91	TP 95	TP 97	1,680	-	7
		15252406	15252406N		6	TR 91	TP 95	TP 97	1,984	-	6
		15252407	15252407N		7	TR 91	TP 95	TP 97	2,308	-	5
		15252408	15252408N		8	TR 91	TP 95	TP 97	2,642	-	4
		15252409	15252409N		9	TR 91	TP 95	TP 97	2,956	-	4
		15252410	15252410N		10	TR 91	TP 95	TP 97	3,280	-	5
		15252411	15252411N		11	TR 91	TP 95	TP 97	3,604	-	5
		15252412	15252412N		12	TR 91	TP 95	TP 97	3,908	-	5

CD 474

yellow surface	nickel plated	CODE	CODE	SIZE	OUTLETS N°						
		15252702	15252702N	G 1" x G 3/4 EK	2	TR 91/A	TP 98	TP 99	0,688	-	18
		15252703	15252703N		3	TR 91/A	TP 98	TP 99	1,007	-	12
		15252704	15252704N		4	TR 91/A	TP 98	TP 99	1,336	-	7
		15252705	15252705N		5	TR 91/A	TP 98	TP 99	1,705	-	7
		15252706	15252706N		6	TR 91/A	TP 98	TP 99	2,014	-	6
		15252707	15252707N		7	TR 91/A	TP 98	TP 99	2,343	-	5
		15252708	15252708N		8	TR 91/A	TP 98	TP 99	2,682	-	4
		15252709	15252709N		9	TR 91/A	TP 98	TP 99	3,008	-	4
		15252710	15252710N		10	TR 91/A	TP 98	TP 99	3,330	-	5
		15252711	15252711N		11	TR 91/A	TP 98	TP 99	3,659	-	5
		15252712	15252712N		12	TR 91/A	TP 98	TP 99	3,968	-	5

CD 868

yellow surface	nickel plated	CODE	CODE	SIZE	OUTLETS N°						
		16252402	16252402N	G 1"1/4 x (W24x19)	2	TR 91	TP 95	TP 97	0,854	-	14
		16252403	16252403N		3	TR 91	TP 95	TP 97	1,261	-	10
		16252404	16252404N		4	TR 91	TP 95	TP 97	1,658	-	6
		16252405	16252405N		5	TR 91	TP 95	TP 97	2,055	-	6
		16252406	16252406N		6	TR 91	TP 95	TP 97	2,462	-	5
		16252407	16252407N		7	TR 91	TP 95	TP 97	2,859	-	5
		16252408	16252408N		8	TR 91	TP 95	TP 97	3,236	-	4
		16252409	16252409N		9	TR 91	TP 95	TP 97	3,663	-	4
		16252410	16252410N		10	TR 91	TP 95	TP 97	4,060	-	5
		16252411	16252411N		11	TR 91	TP 95	TP 97	4,497	-	5
		16252412	16252412N		12	TR 91	TP 95	TP 97	4,874	-	5

CD 867

yellow surface	nickel plated	CODE	CODE	SIZE	OUTLETS N°						
		16252702	16252702N	G 1"1/4 x G 3/4 EK	2	TR 91/A	TP 98	TP 99	0,864	-	14
		16252703	16252703N		3	TR 91/A	TP 98	TP 99	1,276	-	10
		16252704	16252704N		4	TR 91/A	TP 98	TP 99	1,678	-	6
		16252705	16252705N		5	TR 91/A	TP 98	TP 99	2,080	-	6
		16252706	16252706N		6	TR 91/A	TP 98	TP 99	2,492	-	5
		16252707	16252707N		7	TR 91/A	TP 98	TP 99	2,894	-	5
		16252708	16252708N		8	TR 91/A	TP 98	TP 99	3,276	-	4
		16252709	16252709N		9	TR 91/A	TP 98	TP 99	3,708	-	4
		16252710	16252710N		10	TR 91/A	TP 98	TP 99	4,110	-	5
		16252711	16252711N		11	TR 91/A	TP 98	TP 99	4,552	-	5
		16252712	16252712N		12	TR 91/A	TP 98	TP 99	4,934	-	5



Fittings for copper pipe



Fittings for plastic pipe



Fittings for multilayer pipe



Fittings: chapter 7



Accessories: chapter 2.A









Drain hole









Pre-assembled distribution manifold with two 1/2 drain holes with regulator/flow meters.







CD 3474

yellow surface	nickel plated	SIZE	OUTLETS N°						
CODE	CODE								
15262402	15262402N	G 1" x (W24x19)	2	TR 91	TP 95	TP 97	0,858	-	12
15262403	15262403N		3	TR 91	TP 95	TP 97	1,182	-	7
15262404	15262404N		4	TR 91	TP 95	TP 97	1,546	-	7
15262405	15262405N		5	TR 91	TP 95	TP 97	1,850	-	6
15262406	15262406N		6	TR 91	TP 95	TP 97	2,174	-	5
15262407	15262407N		7	TR 91	TP 95	TP 97	2,508	-	4
15262408	15262408N		8	TR 91	TP 95	TP 97	2,822	-	4
15262409	15262409N		9	TR 91	TP 95	TP 97	3,146	-	5
15262410	15262410N		10	TR 91	TP 95	TP 97	3,470	-	5
15262411	15262411N		11	TR 91	TP 95	TP 97	3,774	-	5
15262412	15262412N		12	TR 91	TP 95	TP 97	4,128	-	4







CD 2474

yellow surface	nickel plated	SIZE	OUTLETS N°						
CODE	CODE								
15262702	15262702N	G 1" x G 3/4 EK	2	TR 91/A	TP 98	TP 99	0,868	-	12
15262703	15262703N		3	TR 91/A	TP 98	TP 99	1,197	-	7
15262704	15262704N		4	TR 91/A	TP 98	TP 99	1,566	-	7
15262705	15262705N		5	TR 91/A	TP 98	TP 99	1,875	-	6
15262706	15262706N		6	TR 91/A	TP 98	TP 99	2,204	-	5
15262707	15262707N		7	TR 91/A	TP 98	TP 99	2,543	-	4
15262708	15262708N		8	TR 91/A	TP 98	TP 99	2,862	-	4
15262709	15262709N		9	TR 91/A	TP 98	TP 99	3,191	-	5
15262710	15262710N		10	TR 91/A	TP 98	TP 99	3,520	-	5
15262711	15262711N		11	TR 91/A	TP 98	TP 99	3,829	-	5
15262712	15262712N		12	TR 91/A	TP 98	TP 99	4,188	-	4

CD 870

yellow surface	nickel plated	SIZE	OUTLETS N°						
CODE	CODE								
16262402	16262402N	G 1"1/4 x (W24x19)	2	TR 91	TP 95	TP 97	1,114	-	10
16262403	16262403N		3	TR 91	TP 95	TP 97	1,511	-	6
16262404	16262404N		4	TR 91	TP 95	TP 97	1,908	-	6
16262405	16262405N		5	TR 91	TP 95	TP 97	2,315	-	5
16262406	16262406N		6	TR 91	TP 95	TP 97	2,712	-	5
16262407	16262407N		7	TR 91	TP 95	TP 97	3,089	-	4
16262408	16262408N		8	TR 91	TP 95	TP 97	3,516	-	4
16262409	16262409N		9	TR 91	TP 95	TP 97	3,913	-	5
16262410	16262410N		10	TR 91	TP 95	TP 97	4,350	-	5
16262411	16262411N		11	TR 91	TP 95	TP 97	4,727	-	5
16262412	16262412N		12	TR 91	TP 95	TP 97	5,104	-	4

CD 869

yellow surface	nickel plated	SIZE	OUTLETS N°						
CODE	CODE								
16262702	16262702N	G 1"1/4 x G 3/4 EK	2	TR 91/A	TP 98	TP 99	1,124	-	10
16262703	16262703N		3	TR 91/A	TP 98	TP 99	1,526	-	6
16262704	16262704N		4	TR 91/A	TP 98	TP 99	1,928	-	6
16262705	16262705N		5	TR 91/A	TP 98	TP 99	2,340	-	5
16262706	16262706N		6	TR 91/A	TP 98	TP 99	2,742	-	5
16262707	16262707N		7	TR 91/A	TP 98	TP 99	3,124	-	4
16262708	16262708N		8	TR 91/A	TP 98	TP 99	3,556	-	4
16262709	16262709N		9	TR 91/A	TP 98	TP 99	3,958	-	5
16262710	16262710N		10	TR 91/A	TP 98	TP 99	4,400	-	5
16262711	16262711N		11	TR 91/A	TP 98	TP 99	4,782	-	5
16262712	16262712N		12	TR 91/A	TP 98	TP 99	5,164	-	4





Pre-assembled distribution manifold with manual valves and aluminium discs indicating connected devices.



CD 101

yellow surface		nickel plated		SIZE	OUTLETS N°	TR	TP	TP	kg	-	24
CODE	CODE										
15312402	15312402N	G 1" x (W24x19)	2	TR 91	TP 95	TP 97	0,642	-	24		
15312403	15312403N		3	TR 91	TP 95	TP 97	0,933	-	18		
15312404	15312404N		4	TR 91	TP 95	TP 97	1,244	-	12		
15312405	15312405N		5	TR 91	TP 95	TP 97	1,555	-	10		
15312406	15312406N		6	TR 91	TP 95	TP 97	1,866	-	9		
15312407	15312407N		7	TR 91	TP 95	TP 97	2,177	-	8		
15312408	15312408N		8	TR 91	TP 95	TP 97	2,468	-	8		
15312409	15312409N		9	TR 91	TP 95	TP 97	2,809	-	8		
15312410	15312410N		10	TR 91	TP 95	TP 97	3,090	-	8		
15312411	15312411N		11	TR 91	TP 95	TP 97	3,401	-	8		
15312412	15312412N		12	TR 91	TP 95	TP 97	3,692	-	8		

CD 100







yellow surface		nickel plated		SIZE	OUTLETS N°	TR	TP	TP	kg	-	24
CODE	CODE										
15312702	15312702N	G 1" x G 3/4 EK	2	TR 91/A	TP 98	TP 99	0,660	-	24		
15312703	15312703N		3	TR 91/A	TP 98	TP 99	0,960	-	18		
15312704	15312704N		4	TR 91/A	TP 98	TP 99	1,280	-	12		
15312705	15312705N		5	TR 91/A	TP 98	TP 99	1,600	-	10		
15312706	15312706N		6	TR 91/A	TP 98	TP 99	1,920	-	9		
15312707	15312707N		7	TR 91/A	TP 98	TP 99	2,240	-	8		
15312708	15312708N		8	TR 91/A	TP 98	TP 99	2,540	-	8		
15312709	15312709N		9	TR 91/A	TP 98	TP 99	2,890	-	8		
15312710	15312710N		10	TR 91/A	TP 98	TP 99	3,180	-	8		
15312711	15312711N		11	TR 91/A	TP 98	TP 99	3,500	-	8		
15312712	15312712N		12	TR 91/A	TP 98	TP 99	3,800	-	8		









Distribution manifold consisting of:

- 2 manifolds with pre-assembled RD900 fittings
- 2 metal brackets.







**CD 3459**

yellow surface	nickel plated	SIZE	OUTLETS N°							
CODE	CODE									
15412402	15412402N	G 1" x (W24x19)	2	TR 91	TP 95	TP 97	1,512	1	-	
15412403	15412403N		3	TR 91	TP 95	TP 97	2,008	1	-	
15412404	15412404N		4	TR 91	TP 95	TP 97	2,504	1	-	
15412405	15412405N		5	TR 91	TP 95	TP 97	3,000	1	-	
15412406	15412406N		6	TR 91	TP 95	TP 97	3,496	1	-	
15412407	15412407N		7	TR 91	TP 95	TP 97	3,992	1	-	
15412408	15412408N		8	TR 91	TP 95	TP 97	4,488	1	-	
15412409	15412409N		9	TR 91	TP 95	TP 97	4,984	1	-	
15412410	15412410N		10	TR 91	TP 95	TP 97	5,480	1	-	
15412411	15412411N		11	TR 91	TP 95	TP 97	5,976	1	-	
15412412	15412412N		12	TR 91	TP 95	TP 97	6,472	1	-	







CD 3461

yellow surface	nickel plated	SIZE	OUTLETS N°							
CODE	CODE									
15412702	15412702N	G 1" x G 3/4 EK	2	TR 91/A	TP 98	TP 99	1,560	1	-	
15412703	15412703N		3	TR 91/A	TP 98	TP 99	2,080	1	-	
15412704	15412704N		4	TR 91/A	TP 98	TP 99	2,600	1	-	
15412705	15412705N		5	TR 91/A	TP 98	TP 99	3,130	1	-	
15412706	15412706N		6	TR 91/A	TP 98	TP 99	3,640	1	-	
15412707	15412707N		7	TR 91/A	TP 98	TP 99	4,160	1	-	
15412708	15412708N		8	TR 91/A	TP 98	TP 99	4,680	1	-	
15412709	15412709N		9	TR 91/A	TP 98	TP 99	5,200	1	-	
15412710	15412710N		10	TR 91/A	TP 98	TP 99	5,720	1	-	
15412711	15412711N		11	TR 91/A	TP 98	TP 99	6,240	1	-	
15412712	15412712N		12	TR 91/A	TP 98	TP 99	6,760	1	-	

CD 3862

yellow surface	nickel plated	SIZE	OUTLETS N°							
CODE	CODE									
16412402	16412402N	G 1 1/4 x (W24x19)	2	TR 91	TP 95	TP 97	1,912	1	-	
16412403	16412403N		3	TR 91	TP 95	TP 97	2,540	1	-	
16412404	16412404N		4	TR 91	TP 95	TP 97	3,164	1	-	
16412405	16412405N		5	TR 91	TP 95	TP 97	3,792	1	-	
16412406	16412406N		6	TR 91	TP 95	TP 97	4,416	1	-	
16412407	16412407N		7	TR 91	TP 95	TP 97	5,044	1	-	
16412408	16412408N		8	TR 91	TP 95	TP 97	5,680	1	-	
16412409	16412409N		9	TR 91	TP 95	TP 97	6,296	1	-	
16412410	16412410N		10	TR 91	TP 95	TP 97	6,920	1	-	
16412411	16412411N		11	TR 91	TP 95	TP 97	7,548	1	-	
16412412	16412412N		12	TR 91	TP 95	TP 97	8,172	1	-	

CD 3864

yellow surface	nickel plated	SIZE	OUTLETS N°							
CODE	CODE									
16412702	16412702N	G 1 1/4 x G 3/4 EK	2	TR 91/A	TP 98	TP 99	1,960	1	-	
16412703	16412703N		3	TR 91/A	TP 98	TP 99	2,618	1	-	
16412704	16412704N		4	TR 91/A	TP 98	TP 99	3,260	1	-	
16412705	16412705N		5	TR 91/A	TP 98	TP 99	3,912	1	-	
16412706	16412706N		6	TR 91/A	TP 98	TP 99	4,560	1	-	
16412707	16412707N		7	TR 91/A	TP 98	TP 99	5,212	1	-	
16412708	16412708N		8	TR 91/A	TP 98	TP 99	5,860	1	-	
16412709	16412709N		9	TR 91/A	TP 98	TP 99	6,512	1	-	
16412710	16412710N		10	TR 91/A	TP 98	TP 99	7,160	1	-	
16412711	16412711N		11	TR 91/A	TP 98	TP 99	7,812	1	-	
16412712	16412712N		12	TR 91/A	TP 98	TP 99	8,460	1	-	

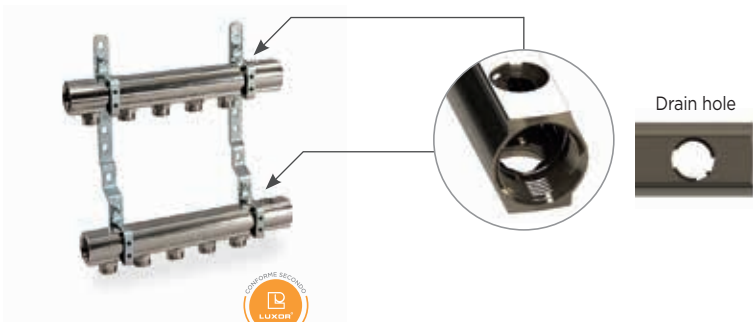

Distribution manifold with 2 1/2" drain holes consisting of:

- 2 manifolds with pre-assembled RD900 fittings
- 2 metal brackets.

CD 3460

yellow surface		nickel plated		SIZE	OUTLETS N°	TR 91	TP 95	TP 97	kg	📦	📦
CODE	CODE	CODE	CODE								
15422402	15422402N			G 1" x (W24x19)	2	TR 91	TP 95	TP 97	1,450	1	-
15422403	15422403N				3	TR 91	TP 95	TP 97	1,946	1	-
15422404	15422404N				4	TR 91	TP 95	TP 97	2,442	1	-
15422405	15422405N				5	TR 91	TP 95	TP 97	2,938	1	-
15422406	15422406N				6	TR 91	TP 95	TP 97	3,434	1	-
15422407	15422407N				7	TR 91	TP 95	TP 97	3,930	1	-
15422408	15422408N				8	TR 91	TP 95	TP 97	4,426	1	-
15422409	15422409N				9	TR 91	TP 95	TP 97	4,922	1	-
15422410	15422410N				10	TR 91	TP 95	TP 97	5,418	1	-
15422411	15422411N				11	TR 91	TP 95	TP 97	5,914	1	-
15422412	15422412N				12	TR 91	TP 95	TP 97	6,410	1	-

CD 3462

yellow surface		nickel plated		SIZE	OUTLETS N°	TR 91/A	TP 98	TP 99	kg	📦	📦
CODE	CODE	CODE	CODE								
15422702	15422702N			G 1" x G 3/4 EK	2	TR 91/A	TP 98	TP 99	1,489	1	-
15422703	15422703N				3	TR 91/A	TP 98	TP 99	2,009	1	-
15422704	15422704N				4	TR 91/A	TP 98	TP 99	2,529	1	-
15422705	15422705N				5	TR 91/A	TP 98	TP 99	3,049	1	-
15422706	15422706N				6	TR 91/A	TP 98	TP 99	3,569	1	-
15422707	15422707N				7	TR 91/A	TP 98	TP 99	4,089	1	-
15422708	15422708N				8	TR 91/A	TP 98	TP 99	4,609	1	-
15422709	15422709N				9	TR 91/A	TP 98	TP 99	5,129	1	-
15422710	15422710N				10	TR 91/A	TP 98	TP 99	5,649	1	-
15422711	15422711N				11	TR 91/A	TP 98	TP 99	6,169	1	-
15422712	15422712N				12	TR 91/A	TP 98	TP 99	6,689	1	-

CD 3863

yellow surface		nickel plated		SIZE	OUTLETS N°	TR 91	TP 95	TP 97	kg	📦	📦
CODE	CODE	CODE	CODE								
16422402	16422402N			G 1"1/4 x (W24x19)	2	TR 91	TP 95	TP 97	1,850	1	-
16422403	16422403N				3	TR 91	TP 95	TP 97	2,478	1	-
16422404	16422404N				4	TR 91	TP 95	TP 97	3,102	1	-
16422405	16422405N				5	TR 91	TP 95	TP 97	3,730	1	-
16422406	16422406N				6	TR 91	TP 95	TP 97	4,354	1	-
16422407	16422407N				7	TR 91	TP 95	TP 97	4,982	1	-
16422408	16422408N				8	TR 91	TP 95	TP 97	5,606	1	-
16422409	16422409N				9	TR 91	TP 95	TP 97	6,234	1	-
16422410	16422410N				10	TR 91	TP 95	TP 97	6,858	1	-
16422411	16422411N				11	TR 91	TP 95	TP 97	7,486	1	-
16422412	16422412N				12	TR 91	TP 95	TP 97	8,110	1	-

CD 3865

yellow surface		nickel plated		SIZE	OUTLETS N°	TR 91/A	TP 98	TP 99	kg	📦	📦
CODE	CODE	CODE	CODE								
16422702	16422702N			G 1"1/4 x G 3/4 EK	2	TR 91/A	TP 98	TP 99	1,889	1	-
16422703	16422703N				3	TR 91/A	TP 98	TP 99	2,547	1	-
16422704	16422704N				4	TR 91/A	TP 98	TP 99	3,189	1	-
16422705	16422705N				5	TR 91/A	TP 98	TP 99	3,841	1	-
16422706	16422706N				6	TR 91/A	TP 98	TP 99	4,489	1	-
16422707	16422707N				7	TR 91/A	TP 98	TP 99	5,141	1	-
16422708	16422708N				8	TR 91/A	TP 98	TP 99	5,789	1	-
16422709	16422709N				9	TR 91/A	TP 98	TP 99	6,441	1	-
16422710	16422710N				10	TR 91/A	TP 98	TP 99	7,089	1	-
16422711	16422711N				11	TR 91/A	TP 98	TP 99	7,741	1	-
16422712	16422712N				12	TR 91/A	TP 98	TP 99	8,389	1	-



Pre-assembled distribution manifold consisting of:

- 1 return manifold with built-in valves set for thermoelectric adjustment and protection caps
- 1 inlet manifold with built in lockshields fit for double regulation
- 2 metal brackets.

CD 2465

yellow surface	nickel plated								
CODE	CODE	SIZE	OUTLETS N°						
15512402	15512402N	G 1" x (W24x19)	2	TR 91	TP 95	TP 97	1,830	1	-
15512403	15512403N		3	TR 91	TP 95	TP 97	2,442	1	-
15512404	15512404N		4	TR 91	TP 95	TP 97	3,053	1	-
15512405	15512405N		5	TR 91	TP 95	TP 97	3,665	1	-
15512406	15512406N		6	TR 91	TP 95	TP 97	4,278	1	-
15512407	15512407N		7	TR 91	TP 95	TP 97	4,890	1	-
15512408	15512408N		8	TR 91	TP 95	TP 97	5,502	1	-
15512409	15512409N		9	TR 91	TP 95	TP 97	6,114	1	-
15512410	15512410N		10	TR 91	TP 95	TP 97	6,726	1	-
15512411	15512411N		11	TR 91	TP 95	TP 97	7,338	1	-
15512412	15512412N		12	TR 91	TP 95	TP 97	7,950	1	-
15512413	15512413N		13	TR 91	TP 95	TP 97	8,562	1	-

CD 2468

yellow surface	nickel plated								
CODE	CODE	SIZE	OUTLETS N°						
15512702	15512702N	G 1" x G 3/4 EK	2	TR 91/A	TP 98	TP 99	1,870	1	-
15512703	15512703N		3	TR 91/A	TP 98	TP 99	2,502	1	-
15512704	15512704N		4	TR 91/A	TP 98	TP 99	3,134	1	-
15512705	15512705N		5	TR 91/A	TP 98	TP 99	3,766	1	-
15512706	15512706N		6	TR 91/A	TP 98	TP 99	4,398	1	-
15512707	15512707N		7	TR 91/A	TP 98	TP 99	5,030	1	-
15512708	15512708N		8	TR 91/A	TP 98	TP 99	5,662	1	-
15512709	15512709N		9	TR 91/A	TP 98	TP 99	6,294	1	-
15512710	15512710N		10	TR 91/A	TP 98	TP 99	6,926	1	-
15512711	15512711N		11	TR 91/A	TP 98	TP 99	7,558	1	-
15512712	15512712N		12	TR 91/A	TP 98	TP 99	8,190	1	-
15512713	15512713N		13	TR 91/A	TP 98	TP 99	8,822	1	-

CD 2865

yellow surface	nickel plated								
CODE	CODE	SIZE	OUTLETS N°						
16512402	16512402N	G 1 1/4 x (W24x19)	2	TR 91	TP 95	TP 97	2,174	1	-
16512403	16512403N		3	TR 91	TP 95	TP 97	2,906	1	-
16512404	16512404N		4	TR 91	TP 95	TP 97	3,638	1	-
16512405	16512405N		5	TR 91	TP 95	TP 97	4,370	1	-
16512406	16512406N		6	TR 91	TP 95	TP 97	5,102	1	-
16512407	16512407N		7	TR 91	TP 95	TP 97	5,834	1	-
16512408	16512408N		8	TR 91	TP 95	TP 97	6,566	1	-
16512409	16512409N		9	TR 91	TP 95	TP 97	7,298	1	-
16512410	16512410N		10	TR 91	TP 95	TP 97	8,030	1	-
16512411	16512411N		11	TR 91	TP 95	TP 97	8,762	1	-
16512412	16512412N		12	TR 91	TP 95	TP 97	9,494	1	-
16512413	16512413N		13	TR 91	TP 95	TP 97	10,226	1	-

CD 2868

yellow surface	nickel plated								
CODE	CODE	SIZE	OUTLETS N°						
16512702	16512702N	G 1 1/4 x G 3/4 EK	2	TR 91/A	TP 98	TP 99	2,214	1	-
16512703	16512703N		3	TR 91/A	TP 98	TP 99	2,966	1	-
16512704	16512704N		4	TR 91/A	TP 98	TP 99	3,718	1	-
16512705	16512705N		5	TR 91/A	TP 98	TP 99	4,470	1	-
16512706	16512706N		6	TR 91/A	TP 98	TP 99	5,222	1	-
16512707	16512707N		7	TR 91/A	TP 98	TP 99	5,974	1	-
16512708	16512708N		8	TR 91/A	TP 98	TP 99	6,726	1	-
16512709	16512709N		9	TR 91/A	TP 98	TP 99	7,478	1	-
16512710	16512710N		10	TR 91/A	TP 98	TP 99	8,230	1	-
16512711	16512711N		11	TR 91/A	TP 98	TP 99	8,982	1	-
16512712	16512712N		12	TR 91/A	TP 98	TP 99	9,734	1	-
16512713	16512713N		13	TR 91/A	TP 98	TP 99	10,486	1	-

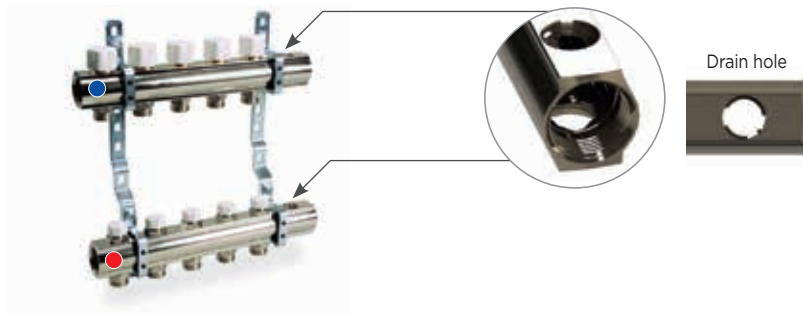

Pre-assembled distribution manifold with two 1/2 drain holes consisting of:

- 1 return manifold with built-in valves set for thermoelectric adjustment and protection caps
- 1 inlet manifold with built-in lockshields fit for double regulation
- 2 metal brackets.

CD 2467

yellow surface	nickel plated	CODE	CODE	SIZE	OUTLETS N°						
		15522402	15522402N	G 1" x (W24x19)	2	TR 91	TP 95	TP 97	2,210	1	-
		15522403	15522403N		3	TR 91	TP 95	TP 97	2,822	1	-
		15522404	15522404N		4	TR 91	TP 95	TP 97	3,434	1	-
		15522405	15522405N		5	TR 91	TP 95	TP 97	4,046	1	-
		15522406	15522406N		6	TR 91	TP 95	TP 97	4,658	1	-
		15522407	15522407N		7	TR 91	TP 95	TP 97	5,270	1	-
		15522408	15522408N		8	TR 91	TP 95	TP 97	5,882	1	-
		15522409	15522409N		9	TR 91	TP 95	TP 97	6,494	1	-
		15522410	15522410N		10	TR 91	TP 95	TP 97	7,106	1	-
		15522411	15522411N		11	TR 91	TP 95	TP 97	7,718	1	-
		15522412	15522412N		12	TR 91	TP 95	TP 97	8,330	1	-

CD 2469

yellow surface	nickel plated	CODE	CODE	SIZE	OUTLETS N°						
		15522702	15522702N	G 1" x G 3/4 EK	2	TR 91/A	TP 98	TP 99	2,250	1	-
		15522703	15522703N		3	TR 91/A	TP 98	TP 99	2,882	1	-
		15522704	15522704N		4	TR 91/A	TP 98	TP 99	3,514	1	-
		15522705	15522705N		5	TR 91/A	TP 98	TP 99	4,146	1	-
		15522706	15522706N		6	TR 91/A	TP 98	TP 99	4,778	1	-
		15522707	15522707N		7	TR 91/A	TP 98	TP 99	5,410	1	-
		15522708	15522708N		8	TR 91/A	TP 98	TP 99	6,042	1	-
		15522709	15522709N		9	TR 91/A	TP 98	TP 99	6,674	1	-
		15522710	15522710N		10	TR 91/A	TP 98	TP 99	7,306	1	-
		15522711	15522711N		11	TR 91/A	TP 98	TP 99	7,938	1	-
		15522712	15522712N		12	TR 91/A	TP 98	TP 99	8,570	1	-

CD 2867

yellow surface	nickel plated	CODE	CODE	SIZE	OUTLETS N°						
		16522402	16522402N	G 1"1/4 x (W24x19)	2	TR 91	TP 95	TP 97	2,674	1	-
		16522403	16522403N		3	TR 91	TP 95	TP 97	3,406	1	-
		16522404	16522404N		4	TR 91	TP 95	TP 97	4,138	1	-
		16522405	16522405N		5	TR 91	TP 95	TP 97	4,870	1	-
		16522406	16522406N		6	TR 91	TP 95	TP 97	5,602	1	-
		16522407	16522407N		7	TR 91	TP 95	TP 97	6,334	1	-
		16522408	16522408N		8	TR 91	TP 95	TP 97	7,066	1	-
		16522409	16522409N		9	TR 91	TP 95	TP 97	7,798	1	-
		16522410	16522410N		10	TR 91	TP 95	TP 97	8,530	1	-
		16522411	16522411N		11	TR 91	TP 95	TP 97	9,262	1	-
		16522412	16522412N		12	TR 91	TP 95	TP 97	9,994	1	-

CD 2869

yellow surface	nickel plated	CODE	CODE	SIZE	OUTLETS N°						
		16522702	16522702	G 1"1/4 x G 3/4 EK	2	TR 91/A	TP 98	TP 99	2,714	1	-
		16522703	16522703		3	TR 91/A	TP 98	TP 99	3,466	1	-
		16522704	16522704		4	TR 91/A	TP 98	TP 99	4,218	1	-
		16522705	16522705		5	TR 91/A	TP 98	TP 99	4,970	1	-
		16522706	16522706		6	TR 91/A	TP 98	TP 99	5,722	1	-
		16522707	16522707		7	TR 91/A	TP 98	TP 99	6,474	1	-
		16522708	16522708		8	TR 91/A	TP 98	TP 99	7,226	1	-
		16522709	16522709		9	TR 91/A	TP 98	TP 99	7,978	1	-
		16522710	16522710		10	TR 91/A	TP 98	TP 99	8,730	1	-
		16522711	16522711		11	TR 91/A	TP 98	TP 99	9,482	1	-
		16522712	16522712		12	TR 91/A	TP 98	TP 99	10,234	1	-



Fittings for copper pipe



Fittings for plastic pipe



Fittings for multilayer pipe



Fittings: chapter 7





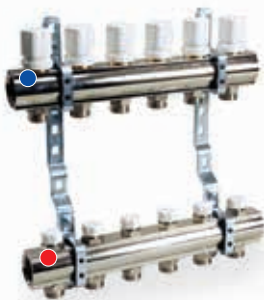



Accessories: chapter 2.A









Pre-assembled distribution manifold consisting of:

- 1 return manifold with built-in valves set for thermoelectric adjustment and manual control knob
- 1 inlet manifold with built in lockshields fit for double regulation
- 2 metal brackets.







CD 465

yellow surface	nickel plated	SIZE	OUTLETS N°						
CODE	CODE								
15552402	15552402N	G 1" x (W24x19)	2	TR 91	TP 95	TP 97	1,850	1	-
15552403	15552403N		3	TR 91	TP 95	TP 97	2,472	1	-
15552404	15552404N		4	TR 91	TP 95	TP 97	3,094	1	-
15552405	15552405N		5	TR 91	TP 95	TP 97	3,716	1	-
15552406	15552406N		6	TR 91	TP 95	TP 97	4,338	1	-
15552407	15552407N		7	TR 91	TP 95	TP 97	4,960	1	-
15552408	15552408N		8	TR 91	TP 95	TP 97	5,582	1	-
15552409	15552409N		9	TR 91	TP 95	TP 97	6,204	1	-
15552410	15552410N		10	TR 91	TP 95	TP 97	6,826	1	-
15552411	15552411N		11	TR 91	TP 95	TP 97	7,448	1	-
15552412	15552412N		12	TR 91	TP 95	TP 97	8,070	1	-
15552413	15552413N		13	TR 91	TP 95	TP 97	8,692	1	-







CD 468

yellow surface	nickel plated	SIZE	OUTLETS N°						
CODE	CODE								
15552702	15552702N	G 1" x G 3/4 EK	2	TR 91/A	TP 98	TP 99	1,890	1	-
15552703	15552703N		3	TR 91/A	TP 98	TP 99	2,532	1	-
15552704	15552704N		4	TR 91/A	TP 98	TP 99	3,174	1	-
15552705	15552705N		5	TR 91/A	TP 98	TP 99	3,816	1	-
15552706	15552706N		6	TR 91/A	TP 98	TP 99	4,458	1	-
15552707	15552707N		7	TR 91/A	TP 98	TP 99	5,100	1	-
15552708	15552708N		8	TR 91/A	TP 98	TP 99	5,742	1	-
15552709	15552709N		9	TR 91/A	TP 98	TP 99	6,384	1	-
15552710	15552710N		10	TR 91/A	TP 98	TP 99	7,026	1	-
15552711	15552711N		11	TR 91/A	TP 98	TP 99	7,668	1	-
15552712	15552712N		12	TR 91/A	TP 98	TP 99	8,310	1	-
15552713	15552713N		13	TR 91/A	TP 98	TP 99	8,952	1	-

CD 1865

yellow surface	nickel plated	SIZE	OUTLETS N°						
CODE	CODE								
16552402	16552402N	G 1 1/4 x (W24x19)	2	TR 91	TP 95	TP 97	2,194	1	-
16552403	16552403N		3	TR 91	TP 95	TP 97	2,936	1	-
16552404	16552404N		4	TR 91	TP 95	TP 97	3,678	1	-
16552405	16552405N		5	TR 91	TP 95	TP 97	4,420	1	-
16552406	16552406N		6	TR 91	TP 95	TP 97	5,162	1	-
16552407	16552407N		7	TR 91	TP 95	TP 97	5,904	1	-
16552408	16552408N		8	TR 91	TP 95	TP 97	6,646	1	-
16552409	16552409N		9	TR 91	TP 95	TP 97	7,388	1	-
16552410	16552410N		10	TR 91	TP 95	TP 97	8,130	1	-
16552411	16552411N		11	TR 91	TP 95	TP 97	8,872	1	-
16552412	16552412N		12	TR 91	TP 95	TP 97	9,614	1	-
16552413	16552413N		13	TR 91	TP 95	TP 97	10,356	1	-

CD 1868

yellow surface	nickel plated	SIZE	OUTLETS N°						
CODE	CODE								
16552702	16552702N	G 1 1/4 x G 3/4 EK	2	TR 91/A	TP 98	TP 99	2,234	1	-
16552703	16552703N		3	TR 91/A	TP 98	TP 99	2,996	1	-
16552704	16552704N		4	TR 91/A	TP 98	TP 99	3,758	1	-
16552705	16552705N		5	TR 91/A	TP 98	TP 99	4,520	1	-
16552706	16552706N		6	TR 91/A	TP 98	TP 99	5,282	1	-
16552707	16552707N		7	TR 91/A	TP 98	TP 99	6,044	1	-
16552708	16552708N		8	TR 91/A	TP 98	TP 99	6,806	1	-
16552709	16552709N		9	TR 91/A	TP 98	TP 99	7,568	1	-
16552710	16552710N		10	TR 91/A	TP 98	TP 99	8,330	1	-
16552711	16552711N		11	TR 91/A	TP 98	TP 99	9,092	1	-
16552712	16552712N		12	TR 91/A	TP 98	TP 99	9,854	1	-
16552713	16552713N		13	TR 91/A	TP 98	TP 99	10,616	1	-





- Pre-assembled distribution manifold with two 1/2 drain holes consisting of:
- 1 return manifold with built-in valves set for thermoelectric adjustment and manual control knob
 - 1 inlet manifold with built-in lockshields fit for double regulation
 - 2 metal brackets.

CD 467

yellow surface	nickel plated	SIZE	OUTLETS N°						
CODE	CODE								
15562402	15562402N	G 1" x (W24x19)	2	TR 91	TP 95	TP 97	2,230	1	-
15562403	15562403N		3	TR 91	TP 95	TP 97	2,852	1	-
15562404	15562404N		4	TR 91	TP 95	TP 97	3,474	1	-
15562405	15562405N		5	TR 91	TP 95	TP 97	4,096	1	-
15562406	15562406N		6	TR 91	TP 95	TP 97	4,718	1	-
15562407	15562407N		7	TR 91	TP 95	TP 97	5,340	1	-
15562408	15562408N		8	TR 91	TP 95	TP 97	5,962	1	-
15562409	15562409N		9	TR 91	TP 95	TP 97	6,584	1	-
15562410	15562410N		10	TR 91	TP 95	TP 97	7,206	1	-
15562411	15562411N		11	TR 91	TP 95	TP 97	7,828	1	-
15562412	15562412N		12	TR 91	TP 95	TP 97	8,450	1	-

CD 469

yellow surface	nickel plated	SIZE	OUTLETS N°						
CODE	CODE								
15562702	15562702N	G 1" x G 3/4 EK	2	TR 91/A	TP 98	TP 99	2,270	1	-
15562703	15562703N		3	TR 91/A	TP 98	TP 99	2,912	1	-
15562704	15562704N		4	TR 91/A	TP 98	TP 99	3,554	1	-
15562705	15562705N		5	TR 91/A	TP 98	TP 99	4,196	1	-
15562706	15562706N		6	TR 91/A	TP 98	TP 99	4,838	1	-
15562707	15562707N		7	TR 91/A	TP 98	TP 99	5,480	1	-
15562708	15562708N		8	TR 91/A	TP 98	TP 99	6,122	1	-
15562709	15562709N		9	TR 91/A	TP 98	TP 99	6,764	1	-
15562710	15562710N		10	TR 91/A	TP 98	TP 99	7,406	1	-
15562711	15562711N		11	TR 91/A	TP 98	TP 99	8,048	1	-
15562712	15562712N		12	TR 91/A	TP 98	TP 99	8,690	1	-

CD 1867

yellow surface	nickel plated	SIZE	OUTLETS N°						
CODE	CODE								
16562402	16562402N	G 1 1/4 x (W24x19)	2	TR 91	TP 95	TP 97	2,694	1	-
16562403	16562403N		3	TR 91	TP 95	TP 97	3,436	1	-
16562404	16562404N		4	TR 91	TP 95	TP 97	4,178	1	-
16562405	16562405N		5	TR 91	TP 95	TP 97	4,920	1	-
16562406	16562406N		6	TR 91	TP 95	TP 97	5,662	1	-
16562407	16562407N		7	TR 91	TP 95	TP 97	6,404	1	-
16562408	16562408N		8	TR 91	TP 95	TP 97	7,146	1	-
16562409	16562409N		9	TR 91	TP 95	TP 97	7,888	1	-
16562410	16562410N		10	TR 91	TP 95	TP 97	8,630	1	-
16562411	16562411N		11	TR 91	TP 95	TP 97	9,372	1	-
16562412	16562412N		12	TR 91	TP 95	TP 97	10,114	1	-

CD 1869

yellow surface	nickel plated	SIZE	OUTLETS N°						
CODE	CODE								
16562702	16562702N	G 1 1/4 x G 3/4 EK	2	TR 91/A	TP 98	TP 99	2,734	1	-
16562703	16562703N		3	TR 91/A	TP 98	TP 99	3,496	1	-
16562704	16562704N		4	TR 91/A	TP 98	TP 99	4,258	1	-
16562705	16562705N		5	TR 91/A	TP 98	TP 99	5,020	1	-
16562706	16562706N		6	TR 91/A	TP 98	TP 99	5,782	1	-
16562707	16562707N		7	TR 91/A	TP 98	TP 99	6,544	1	-
16562708	16562708N		8	TR 91/A	TP 98	TP 99	7,306	1	-
16562709	16562709N		9	TR 91/A	TP 98	TP 99	8,068	1	-
16562710	16562710N		10	TR 91/A	TP 98	TP 99	8,830	1	-
16562711	16562711N		11	TR 91/A	TP 98	TP 99	9,592	1	-
16562712	16562712N		12	TR 91/A	TP 98	TP 99	10,354	1	-



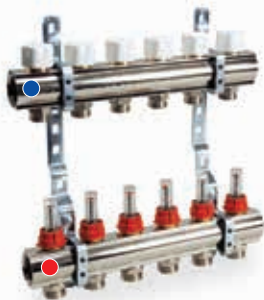













Pre-assembled distribution manifold consisting of:

- 1 return manifold with built-in valves set for thermoelectric adjustment and protection caps
- 1 inlet manifold with regulator/flow meters
- 2 metal brackets.







CD 2478

yellow surface	nickel plated	CODE	SIZE	OUTLETS N°						
CODE	CODE									
15612402	15612402N	G 1" x (W24x19)	2	TR 91	TP 95	TP 97	1,562	1	-	
15612403	15612403N		3	TR 91	TP 95	TP 97	2,188	1	-	
15612404	15612404N		4	TR 91	TP 95	TP 97	2,824	1	-	
15612405	15612405N		5	TR 91	TP 95	TP 97	3,500	1	-	
15612406	15612406N		6	TR 91	TP 95	TP 97	4,116	1	-	
15612407	15612407N		7	TR 91	TP 95	TP 97	4,752	1	-	
15612408	15612408N		8	TR 91	TP 95	TP 97	5,398	1	-	
15612409	15612409N		9	TR 91	TP 95	TP 97	6,024	1	-	
15612410	15612410N		10	TR 91	TP 95	TP 97	6,660	1	-	
15612411	15612411N		11	TR 91	TP 95	TP 97	7,296	1	-	
15612412	15612412N		12	TR 91	TP 95	TP 97	7,912	1	-	
15612413	15612413N		13	TR 91	TP 95	TP 97	8,528	1	-	







CD 2473

yellow surface	nickel plated	CODE	SIZE	OUTLETS N°						
CODE	CODE									
15612702	15612702N	G 1" x G 3/4 EK	2	TR 91/A	TP 98	TP 99	1,592	1	-	
15612703	15612703N		3	TR 91/A	TP 98	TP 99	2,233	1	-	
15612704	15612704N		4	TR 91/A	TP 98	TP 99	2,884	1	-	
15612705	15612705N		5	TR 91/A	TP 98	TP 99	3,575	1	-	
15612706	15612706N		6	TR 91/A	TP 98	TP 99	4,206	1	-	
15612707	15612707N		7	TR 91/A	TP 98	TP 99	4,857	1	-	
15612708	15612708N		8	TR 91/A	TP 98	TP 99	5,518	1	-	
15612709	15612709N		9	TR 91/A	TP 98	TP 99	6,159	1	-	
15612710	15612710N		10	TR 91/A	TP 98	TP 99	6,810	1	-	
15612711	15612711N		11	TR 91/A	TP 98	TP 99	7,461	1	-	
15612712	15612712N		12	TR 91/A	TP 98	TP 99	8,092	1	-	
15612713	15612713N		13	TR 91/A	TP 98	TP 99	8,723	1	-	

CD 2878

yellow surface	nickel plated	CODE	SIZE	OUTLETS N°						
CODE	CODE									
16612402	16612402N	G 1 1/4 x (W24x19)	2	TR 91	TP 95	TP 97	1,928	1	-	
16612403	16612403N		3	TR 91	TP 95	TP 97	2,707	1	-	
16612404	16612404N		4	TR 91	TP 95	TP 97	3,476	1	-	
16612405	16612405N		5	TR 91	TP 95	TP 97	4,295	1	-	
16612406	16612406N		6	TR 91	TP 95	TP 97	5,024	1	-	
16612407	16612407N		7	TR 91	TP 95	TP 97	5,793	1	-	
16612408	16612408N		8	TR 91	TP 95	TP 97	6,542	1	-	
16612409	16612409N		9	TR 91	TP 95	TP 97	7,341	1	-	
16612410	16612410N		10	TR 91	TP 95	TP 97	8,110	1	-	
16612411	16612411N		11	TR 91	TP 95	TP 97	9,189	1	-	
16612412	16612412N		12	TR 91	TP 95	TP 97	9,668	1	-	
16612413	16612413N		13	TR 91	TP 95	TP 97	10,147	1	-	

CD 2873

yellow surface	nickel plated	CODE	SIZE	OUTLETS N°						
CODE	CODE									
16612702	16612702N	G 1 1/4 x G 3/4 EK	2	TR 91/A	TP 98	TP 99	1,958	1	-	
16612703	16612703N		3	TR 91/A	TP 98	TP 99	2,752	1	-	
16612704	16612704N		4	TR 91/A	TP 98	TP 99	3,536	1	-	
16612705	16612705N		5	TR 91/A	TP 98	TP 99	4,320	1	-	
16612706	16612706N		6	TR 91/A	TP 98	TP 99	5,114	1	-	
16612707	16612707N		7	TR 91/A	TP 98	TP 99	5,898	1	-	
16612708	16612708N		8	TR 91/A	TP 98	TP 99	6,662	1	-	
16612709	16612709N		9	TR 91/A	TP 98	TP 99	7,476	1	-	
16612710	16612710N		10	TR 91/A	TP 98	TP 99	8,260	1	-	
16612711	16612711N		11	TR 91/A	TP 98	TP 99	9,084	1	-	
16612712	16612712N		12	TR 91/A	TP 98	TP 99	9,848	1	-	
16612713	16612713N		13	TR 91/A	TP 98	TP 99	10,612	1	-	



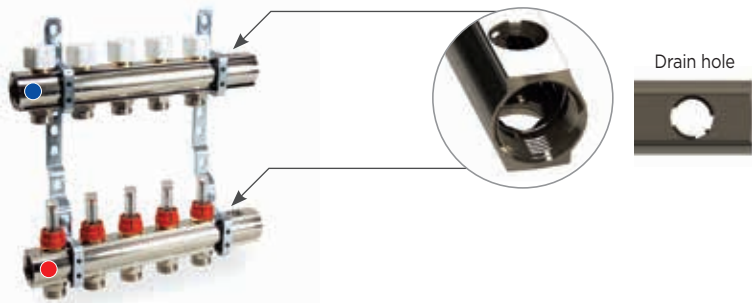

Pre-assembled distribution manifold with 2 1/2" drain holes consisting of:

- 1 return manifold with built-in valves set for thermoelectric adjustment and protection caps
- 1 inlet manifold with regulator/flow meters
- 2 metal brackets.

CD 2479

yellow surface	nickel plated	SIZE	OUTLETS N°						
CODE	CODE								
15622402	15622402N	G 1" x (W24x19)	2	TR 91	TP 95	TP 97	1,932	1	-
15622403	15622403N		3	TR 91	TP 95	TP 97	2,568	1	-
15622404	15622404N		4	TR 91	TP 95	TP 97	3,244	1	-
15622405	15622405N		5	TR 91	TP 95	TP 97	3,860	1	-
15622406	15622406N		6	TR 91	TP 95	TP 97	4,496	1	-
15622407	15622407N		7	TR 91	TP 95	TP 97	5,142	1	-
15622408	15622408N		8	TR 91	TP 95	TP 97	5,768	1	-
15622409	15622409N		9	TR 91	TP 95	TP 97	6,404	1	-
15622410	15622410N		10	TR 91	TP 95	TP 97	7,040	1	-
15622411	15622411N		11	TR 91	TP 95	TP 97	7,656	1	-
15622412	15622412N		12	TR 91	TP 95	TP 97	8,322	1	-

CD 2477

yellow surface	nickel plated	SIZE	OUTLETS N°						
CODE	CODE								
15622702	15622702N	G 1" x G 3/4 EK	2	TR 91/A	TP 98	TP 99	1,962	1	-
15622703	15622703N		3	TR 91/A	TP 98	TP 99	2,613	1	-
15622704	15622704N		4	TR 91/A	TP 98	TP 99	3,304	1	-
15622705	15622705N		5	TR 91/A	TP 98	TP 99	3,935	1	-
15622706	15622706N		6	TR 91/A	TP 98	TP 99	4,586	1	-
15622707	15622707N		7	TR 91/A	TP 98	TP 99	5,247	1	-
15622708	15622708N		8	TR 91/A	TP 98	TP 99	5,888	1	-
15622709	15622709N		9	TR 91/A	TP 98	TP 99	6,539	1	-
15622710	15622710N		10	TR 91/A	TP 98	TP 99	7,190	1	-
15622711	15622711N		11	TR 91/A	TP 98	TP 99	7,821	1	-
15622712	15622712N		12	TR 91/A	TP 98	TP 99	8,502	1	-

CD 2879

yellow surface	nickel plated	SIZE	OUTLETS N°						
CODE	CODE								
16622402	16622402N	G 1 1/4" x (W24x19)	2	TR 91	TP 95	TP 97	2,438	1	-
16622403	16622403N		3	TR 91	TP 95	TP 97	3,207	1	-
16622404	16622404N		4	TR 91	TP 95	TP 97	3,976	1	-
16622405	16622405N		5	TR 91	TP 95	TP 97	4,755	1	-
16622406	16622406N		6	TR 91	TP 95	TP 97	5,524	1	-
16622407	16622407N		7	TR 91	TP 95	TP 97	6,273	1	-
16622408	16622408N		8	TR 91	TP 95	TP 97	7,072	1	-
16622409	16622409N		9	TR 91	TP 95	TP 97	7,841	1	-
16622410	16622410N		10	TR 91	TP 95	TP 97	8,650	1	-
16622411	16622411N		11	TR 91	TP 95	TP 97	9,399	1	-
16622412	16622412N		12	TR 91	TP 95	TP 97	10,148	1	-

CD 2877

yellow surface	nickel plated	SIZE	OUTLETS N°						
CODE	CODE								
16622702	16622702N	G 1 1/4" x G 3/4 EK	2	TR 91/A	TP 98	TP 99	2,468	1	-
16622703	16622703N		3	TR 91/A	TP 98	TP 99	3,252	1	-
16622704	16622704N		4	TR 91/A	TP 98	TP 99	4,036	1	-
16622705	16622705N		5	TR 91/A	TP 98	TP 99	4,830	1	-
16622706	16622706N		6	TR 91/A	TP 98	TP 99	5,614	1	-
16622707	16622707N		7	TR 91/A	TP 98	TP 99	6,378	1	-
16622708	16622708N		8	TR 91/A	TP 98	TP 99	7,192	1	-
16622709	16622709N		9	TR 91/A	TP 98	TP 99	7,976	1	-
16622710	16622710N		10	TR 91/A	TP 98	TP 99	8,800	1	-
16622711	16622711N		11	TR 91/A	TP 98	TP 99	9,564	1	-
16622712	16622712N		12	TR 91/A	TP 98	TP 99	10,328	1	-



Fittings for copper pipe



Fittings for plastic pipe



Fittings for multilayer pipe



Fittings: chapter 7









Accessories: chapter 2.A









Pre-assembled distribution manifold consisting of:

- 1 return manifold with built-in valves set for thermoelectric adjustment and manual control knob
- 1 inlet manifold with regulator/flow meters
- 2 metal brackets.







CD 478

yellow surface	nickel plated								
CODE	CODE	SIZE	OUTLETS N°						
15652402	15652402N	G 1" x (W24x19)	2	TR 91	TP 95	TP 97	1,582	1	-
15652403	15652403N		3	TR 91	TP 95	TP 97	2,218	1	-
15652404	15652404N		4	TR 91	TP 95	TP 97	2,864	1	-
15652405	15652405N		5	TR 91	TP 95	TP 97	3,550	1	-
15652406	15652406N		6	TR 91	TP 95	TP 97	4,176	1	-
15652407	15652407N		7	TR 91	TP 95	TP 97	4,822	1	-
15652408	15652408N		8	TR 91	TP 95	TP 97	5,478	1	-
15652409	15652409N		9	TR 91	TP 95	TP 97	6,114	1	-
15652410	15652410N		10	TR 91	TP 95	TP 97	6,760	1	-
15652411	15652411N		11	TR 91	TP 95	TP 97	7,406	1	-
15652412	15652412N		12	TR 91	TP 95	TP 97	8,032	1	-
15652413	15652413N		13	TR 91	TP 95	TP 97	8,658	1	-







CD 473

yellow surface	nickel plated								
CODE	CODE	SIZE	OUTLETS N°						
15652702	15652702N	G 1" x G 3/4 EK	2	TR 91/A	TP 98	TP 99	1,612	1	-
15652703	15652703N		3	TR 91/A	TP 98	TP 99	2,263	1	-
15652704	15652704N		4	TR 91/A	TP 98	TP 99	2,924	1	-
15652705	15652705N		5	TR 91/A	TP 98	TP 99	3,625	1	-
15652706	15652706N		6	TR 91/A	TP 98	TP 99	4,266	1	-
15652707	15652707N		7	TR 91/A	TP 98	TP 99	4,927	1	-
15652708	15652708N		8	TR 91/A	TP 98	TP 99	5,598	1	-
15652709	15652709N		9	TR 91/A	TP 98	TP 99	6,249	1	-
15652710	15652710N		10	TR 91/A	TP 98	TP 99	6,910	1	-
15652711	15652711N		11	TR 91/A	TP 98	TP 99	7,571	1	-
15652712	15652712N		12	TR 91/A	TP 98	TP 99	8,212	1	-
15652713	15652713N		13	TR 91/A	TP 98	TP 99	8,853	1	-

CD 1878

yellow surface	nickel plated								
CODE	CODE	SIZE	OUTLETS N°						
16652402	16652402N	G 1 1/4 x (W24x19)	2	TR 91	TP 95	TP 97	1,948	1	-
16652403	16652403N		3	TR 91	TP 95	TP 97	2,737	1	-
16652404	16652404N		4	TR 91	TP 95	TP 97	3,516	1	-
16652405	16652405N		5	TR 91	TP 95	TP 97	4,295	1	-
16652406	16652406N		6	TR 91	TP 95	TP 97	5,084	1	-
16652407	16652407N		7	TR 91	TP 95	TP 97	5,863	1	-
16652408	16652408N		8	TR 91	TP 95	TP 97	6,622	1	-
16652409	16652409N		9	TR 91	TP 95	TP 97	7,431	1	-
16652410	16652410N		10	TR 91	TP 95	TP 97	8,210	1	-
16652411	16652411N		11	TR 91	TP 95	TP 97	9,029	1	-
16652412	16652412N		12	TR 91	TP 95	TP 97	9,788	1	-
16652413	16652413N		13	TR 91	TP 95	TP 97	10,547	1	-

CD 1873

yellow surface	nickel plated								
CODE	CODE	SIZE	OUTLETS N°						
16652702	16652702N	G 1 1/4 x G 3/4 EK	2	TR 91/A	TP 98	TP 99	1,978	1	-
16652703	16652703N		3	TR 91/A	TP 98	TP 99	2,782	1	-
16652704	16652704N		4	TR 91/A	TP 98	TP 99	3,576	1	-
16652705	16652705N		5	TR 91/A	TP 98	TP 99	4,370	1	-
16652706	16652706N		6	TR 91/A	TP 98	TP 99	5,174	1	-
16652707	16652707N		7	TR 91/A	TP 98	TP 99	5,968	1	-
16652708	16652708N		8	TR 91/A	TP 98	TP 99	6,742	1	-
16652709	16652709N		9	TR 91/A	TP 98	TP 99	7,566	1	-
16652710	16652710N		10	TR 91/A	TP 98	TP 99	8,360	1	-
16652711	16652711N		11	TR 91/A	TP 98	TP 99	9,194	1	-
16652712	16652712N		12	TR 91/A	TP 98	TP 99	9,968	1	-
16652713	16652713N		13	TR 91/A	TP 98	TP 99	10,742	1	-



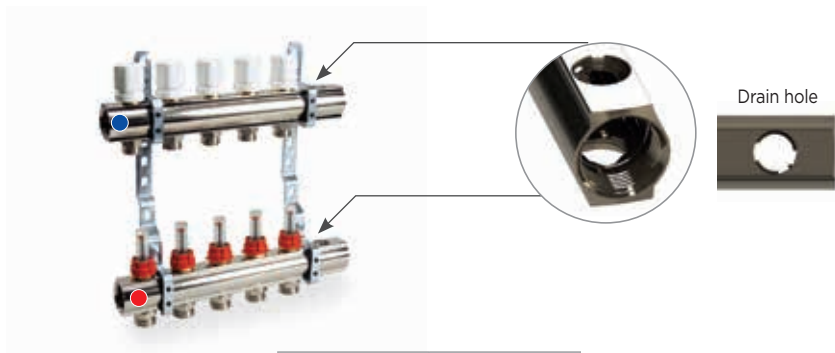

- Pre-assembled distribution manifold with 2 1/2" drain holes consisting of:
- 1 return manifold with built-in valves set for thermoelectric adjustment and manual control knob
 - 1 inlet manifold with regulator/flow meters
 - 2 metal brackets.

CD 479

yellow surface	nickel plated	SIZE	OUTLETS N°						
CODE	CODE								
15662402	15662402N	G 1" x (W24x19)	2	TR 91	TP 95	TP 97	1,952	1	-
15662403	15662403N		3	TR 91	TP 95	TP 97	2,598	1	-
15662404	15662404N		4	TR 91	TP 95	TP 97	3,284	1	-
15662405	15662405N		5	TR 91	TP 95	TP 97	3,910	1	-
15662406	15662406N		6	TR 91	TP 95	TP 97	4,556	1	-
15662407	15662407N		7	TR 91	TP 95	TP 97	5,212	1	-
15662408	15662408N		8	TR 91	TP 95	TP 97	5,848	1	-
15662409	15662409N		9	TR 91	TP 95	TP 97	6,494	1	-
15662410	15662410N		10	TR 91	TP 95	TP 97	7,140	1	-
15662411	15662411N		11	TR 91	TP 95	TP 97	7,766	1	-
15662412	15662412N		12	TR 91	TP 95	TP 97	8,442	1	-

CD 477

yellow surface	nickel plated	SIZE	OUTLETS N°						
CODE	CODE								
15662702	15662702N	G 1" x G 3/4 EK	2	TR 91/A	TP 98	TP 99	1,982	1	-
15662703	15662703N		3	TR 91/A	TP 98	TP 99	2,643	1	-
15662704	15662704N		4	TR 91/A	TP 98	TP 99	3,344	1	-
15662705	15662705N		5	TR 91/A	TP 98	TP 99	3,985	1	-
15662706	15662706N		6	TR 91/A	TP 98	TP 99	4,646	1	-
15662707	15662707N		7	TR 91/A	TP 98	TP 99	5,317	1	-
15662708	15662708N		8	TR 91/A	TP 98	TP 99	5,968	1	-
15662709	15662709N		9	TR 91/A	TP 98	TP 99	6,629	1	-
15662710	15662710N		10	TR 91/A	TP 98	TP 99	7,290	1	-
15662711	15662711N		11	TR 91/A	TP 98	TP 99	7,931	1	-
15662712	15662712N		12	TR 91/A	TP 98	TP 99	8,622	1	-

CD 1879

yellow surface	nickel plated	SIZE	OUTLETS N°						
CODE	CODE								
16662402	16662402N	G 1"1/4 x (W24x19)	2	TR 91	TP 95	TP 97	2,458	1	-
16662403	16662403N		3	TR 91	TP 95	TP 97	3,237	1	-
16662404	16662404N		4	TR 91	TP 95	TP 97	4,016	1	-
16662405	16662405N		5	TR 91	TP 95	TP 97	4,805	1	-
16662406	16662406N		6	TR 91	TP 95	TP 97	5,584	1	-
16662407	16662407N		7	TR 91	TP 95	TP 97	6,343	1	-
16662408	16662408N		8	TR 91	TP 95	TP 97	7,152	1	-
16662409	16662409N		9	TR 91	TP 95	TP 97	7,931	1	-
16662410	16662410N		10	TR 91	TP 95	TP 97	8,750	1	-
16662411	16662411N		11	TR 91	TP 95	TP 97	9,509	1	-
16662412	16662412N		12	TR 91	TP 95	TP 97	10,268	1	-

CD 1877

yellow surface	nickel plated	SIZE	OUTLETS N°						
CODE	CODE								
16662702	16662702N	G 1"1/4 x G 3/4 EK	2	TR 91/A	TP 98	TP 99	2,488	1	-
16662703	16662703N		3	TR 91/A	TP 98	TP 99	3,282	1	-
16662704	16662704N		4	TR 91/A	TP 98	TP 99	4,076	1	-
16662705	16662705N		5	TR 91/A	TP 98	TP 99	4,880	1	-
16662706	16662706N		6	TR 91/A	TP 98	TP 99	5,674	1	-
16662707	16662707N		7	TR 91/A	TP 98	TP 99	6,448	1	-
16662708	16662708N		8	TR 91/A	TP 98	TP 99	7,272	1	-
16662709	16662709N		9	TR 91/A	TP 98	TP 99	8,066	1	-
16662710	16662710N		10	TR 91/A	TP 98	TP 99	8,900	1	-
16662711	16662711N		11	TR 91/A	TP 98	TP 99	9,674	1	-
16662712	16662712N		12	TR 91/A	TP 98	TP 99	10,448	1	-





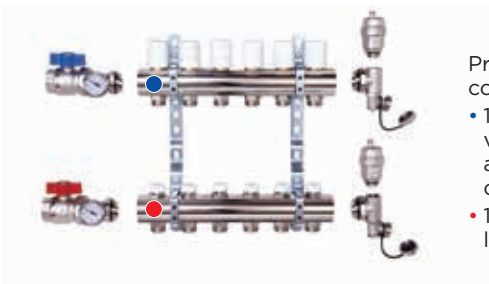



PRE-ASSEMBLED MANIFOLDS WITH INSTALLATION ACCESSORIES









Pre-assembled distribution manifold consisting of:

- 1 return manifold with built-in valves set for thermoelectric adjustment and manual control knob
- 1 inlet manifold with built-in lockshields fit for double regulation.

CD 465M

CODE	SIZE	OUTLETS N°						
15552402MN	G 1" x (W24x19)	2	TR 91	TP 95	TP 97	4,172	1	-
15552403MN		3	TR 91	TP 95	TP 97	4,794	1	-
15552404MN		4	TR 91	TP 95	TP 97	5,416	1	-
15552405MN		5	TR 91	TP 95	TP 97	6,038	1	-
15552406MN		6	TR 91	TP 95	TP 97	6,660	1	-
15552407MN		7	TR 91	TP 95	TP 97	7,282	1	-
15552408MN		8	TR 91	TP 95	TP 97	7,904	1	-
15552409MN		9	TR 91	TP 95	TP 97	8,526	1	-
15552410MN		10	TR 91	TP 95	TP 97	9,148	1	-
15552411MN		11	TR 91	TP 95	TP 97	9,770	1	-
15552412MN		12	TR 91	TP 95	TP 97	10,392	1	-
15552413MN		13	TR 91	TP 95	TP 97	11,014	1	-

CD 468M

CODE	SIZE	OUTLETS N°						
15552702MN	G 1" x G 3/4 EK	2	TR 91/A	TP 98	TP 99	4,212	1	-
15552703MN		3	TR 91/A	TP 98	TP 99	4,854	1	-
15552704MN		4	TR 91/A	TP 98	TP 99	5,496	1	-
15552705MN		5	TR 91/A	TP 98	TP 99	6,138	1	-
15552706MN		6	TR 91/A	TP 98	TP 99	6,780	1	-
15552707MN		7	TR 91/A	TP 98	TP 99	7,422	1	-
15552708MN		8	TR 91/A	TP 98	TP 99	8,064	1	-
15552709MN		9	TR 91/A	TP 98	TP 99	8,706	1	-
15552710MN		10	TR 91/A	TP 98	TP 99	9,348	1	-
15552711MN		11	TR 91/A	TP 98	TP 99	9,990	1	-
15552712MN		12	TR 91/A	TP 98	TP 99	10,632	1	-
15552713MN		13	TR 91/A	TP 98	TP 99	11,274	1	-



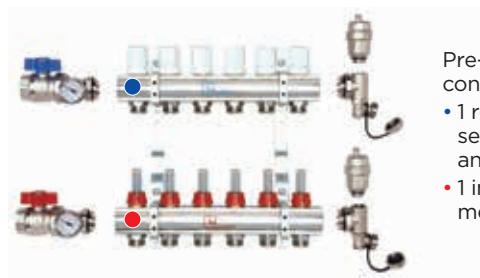

Pre-assembled distribution manifold consisting of:

- 1 return manifold with built-in valves set for thermoelectric adjustment and manual control knob
- 1 inlet manifold with regulator/flow meters.

CD 478M

CODE	SIZE	OUTLETS N°						
15652402MN	G 1" x (W24x19)	2	TR 91	TP 95	TP 97	3,904	1	-
15652403MN		3	TR 91	TP 95	TP 97	4,540	1	-
15652404MN		4	TR 91	TP 95	TP 97	5,186	1	-
15652405MN		5	TR 91	TP 95	TP 97	5,872	1	-
15652406MN		6	TR 91	TP 95	TP 97	6,498	1	-
15652407MN		7	TR 91	TP 95	TP 97	7,144	1	-
15652408MN		8	TR 91	TP 95	TP 97	7,800	1	-
15652409MN		9	TR 91	TP 95	TP 97	8,436	1	-
15652410MN		10	TR 91	TP 95	TP 97	9,082	1	-
15652411MN		11	TR 91	TP 95	TP 97	9,728	1	-
15652412MN		12	TR 91	TP 95	TP 97	10,354	1	-
15652413MN		13	TR 91	TP 95	TP 97	10,98	1	-

CD 473M

CODE	SIZE	OUTLETS N°						
15652702MN	G 1" x G 3/4 EK	2	TR 91/A	TP 98	TP 99	3,934	1	-
15652703MN		3	TR 91/A	TP 98	TP 99	4,585	1	-
15652704MN		4	TR 91/A	TP 98	TP 99	5,246	1	-
15652705MN		5	TR 91/A	TP 98	TP 99	5,947	1	-
15652706MN		6	TR 91/A	TP 98	TP 99	6,588	1	-
15652707MN		7	TR 91/A	TP 98	TP 99	7,249	1	-
15652708MN		8	TR 91/A	TP 98	TP 99	7,920	1	-
15652709MN		9	TR 91/A	TP 98	TP 99	8,571	1	-
15652710MN		10	TR 91/A	TP 98	TP 99	9,232	1	-
15652711MN		11	TR 91/A	TP 98	TP 99	9,893	1	-
15652712MN		12	TR 91/A	TP 98	TP 99	10,534	1	-
15652713MN		13	TR 91/A	TP 98	TP 99	11,175	1	-



Fittings for copper pipe



Fittings for plastic pipe



Fittings for multilayer pipe



Fittings: chapter 7



Accessories: chapter 2.A

MANIFOLDS FLOW RATE CHART

DISTRIBUTION MANIFOLDS WITH FEMALE G 1/2 THREAD

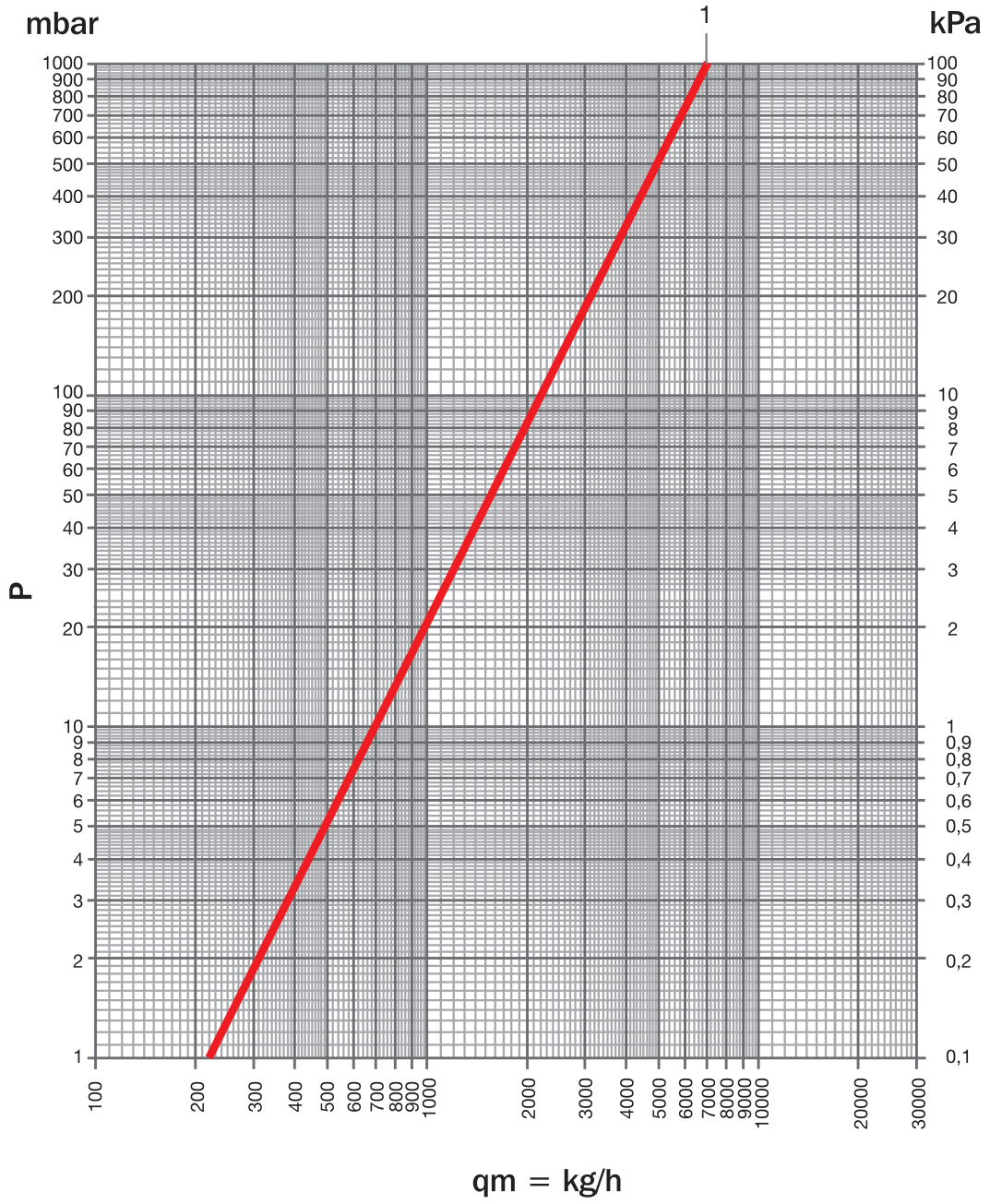

ITEM	SIZE	DRAIN HOLE	Kvs	POS
CD 451	G 3/4	NO	7.00	1
CD 456	G 1"			
CD 860	G 1 1/4			
CD 457	G 1"	YES		
CD 861	G 1 1/4			

MAX SUGGESTED FLOW RATE	
G 3/4	2250 l/h
G 1"	3900 l/h
G 1 1/4	6600 l/h

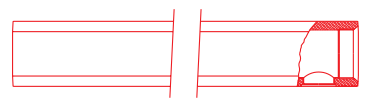

MANIFOLDS FLOW RATE CHART

DISTRIBUTION MANIFOLDS WITH PRE-ASSEMBLED RD 900 FITTINGS

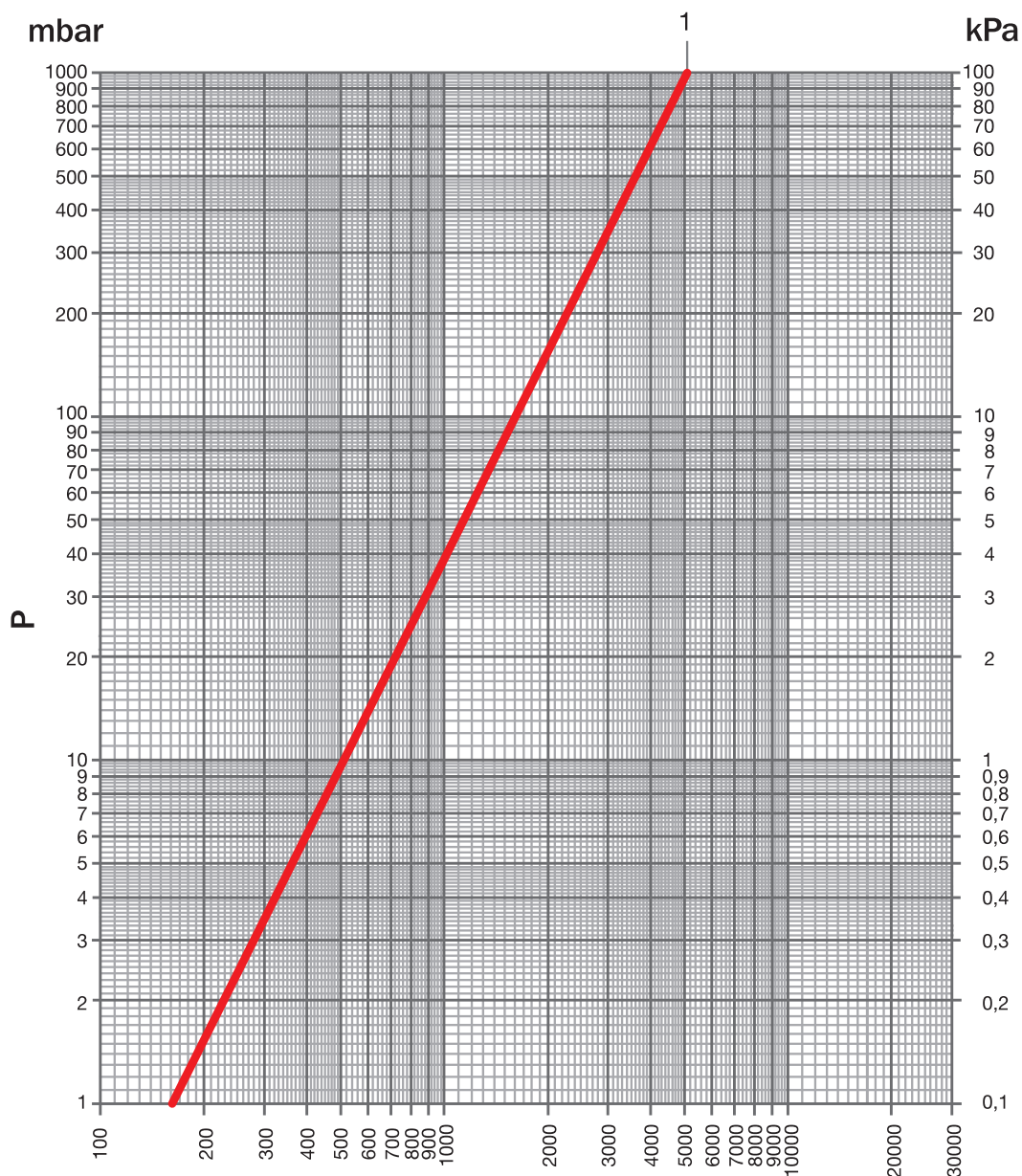

$q_m = \text{kg/h}$

ITEM	SIZE	DRAIN HOLE	Kvs	POS
CD 459	G 1"	NO	5.1	1
CD 461				
CD 862	G 1 1/4"			
CD 864				
CD 460	G 1"	YES	5.1	1
CD 462				
CD 863	G 1 1/4"			
CD 865				

MAX SUGGESTED FLOW RATE	
G 1"	3900 l/h
G 1 1/4"	6600 l/h

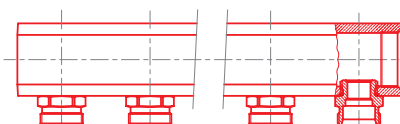

MANIFOLDS FLOW RATE CHART

PRE-ASSEMBLED DISTRIBUTION MANIFOLD WITH MANUAL VALVES

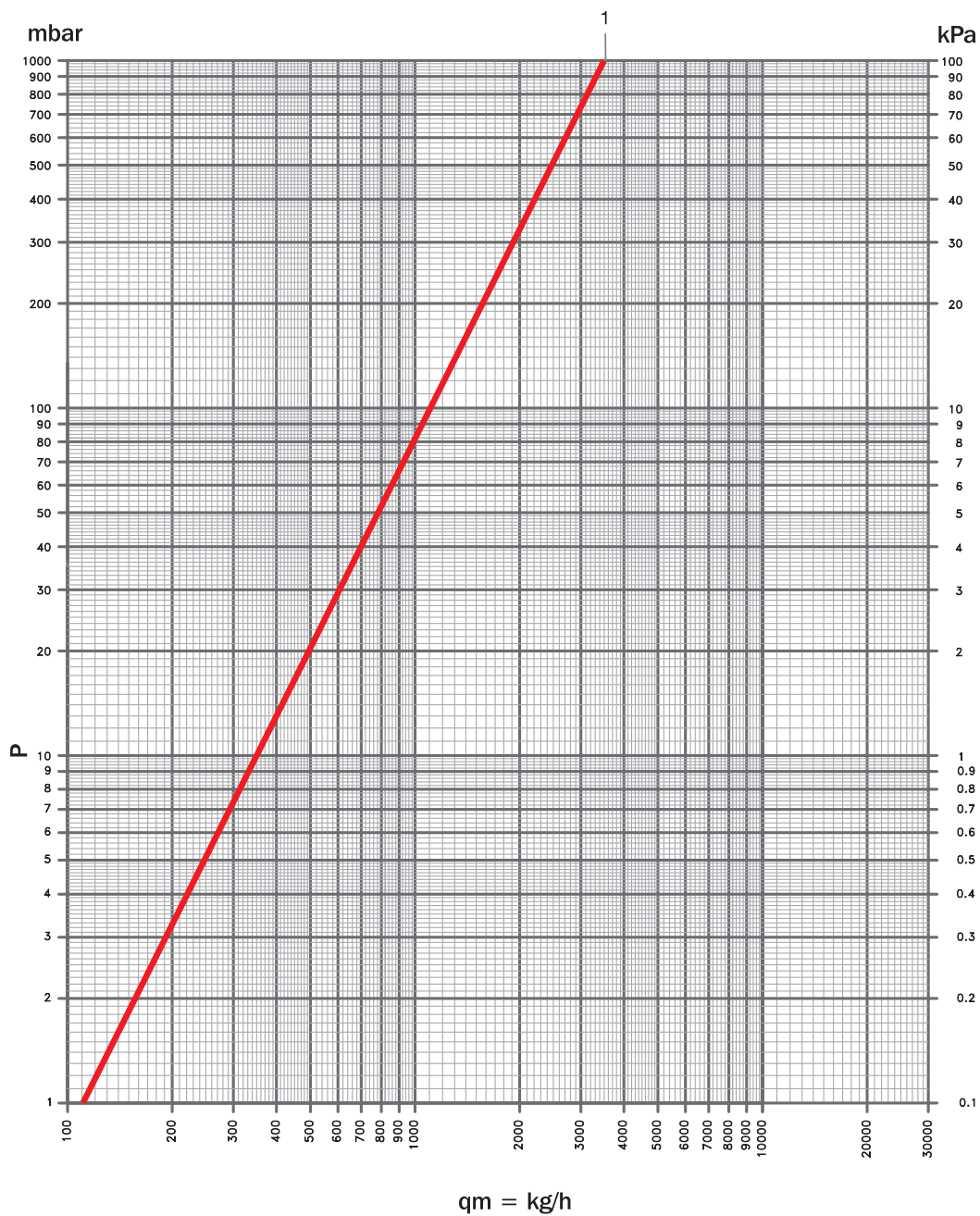

ITEM	SIZE	Kvs	POS
CD 100	G 1"	3.5	1
CD 101			

MAX SUGGESTED FLOW RATE	
G 1"	3900 l/h

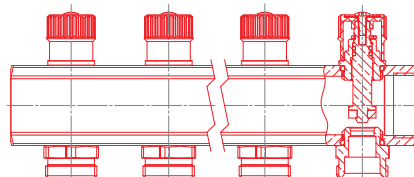

MANIFOLDS FLOW RATE CHART

PRE-ASSEMBLED DISTRIBUTION MANIFOLDS WITH FIT-IN VALVES

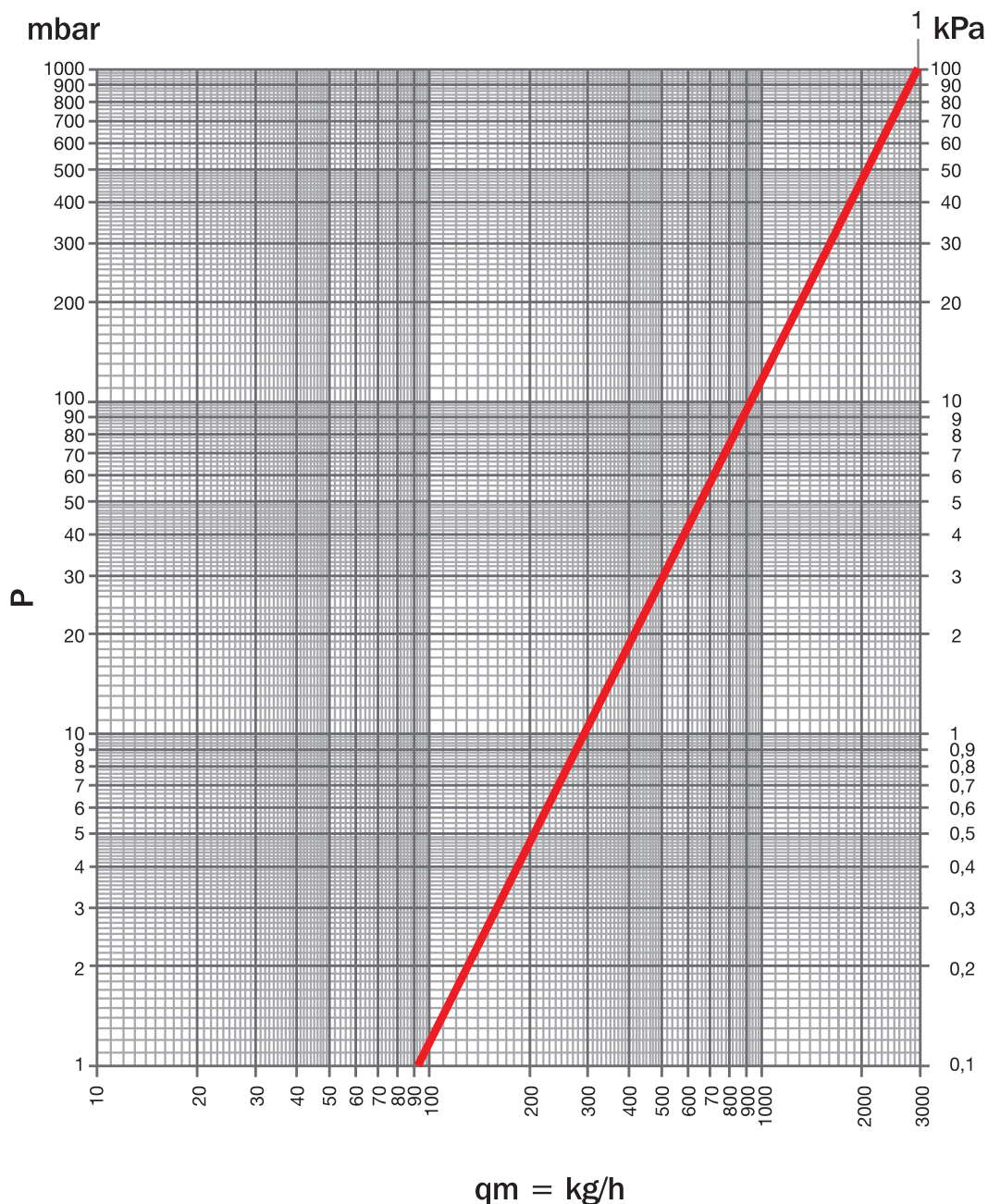

ITEM	SIZE	DRAIN HOLE	Kvs	POS
CD 1466 CD 466 CD 1446 CD 446	G 1"	NO	2.98	1
CD 875 CD 871 CD 876 CD 872	G 1 1/4"			
CD 3466 CD 2466 CD 3446 CD 2446	G 1"	YES		
CD 877 CD 873 CD 878 CD 874	G 1 1/4"			

MAX SUGGESTED FLOW RATE	
G 1"	3900 l/h
G 1 1/4"	6600 l/h

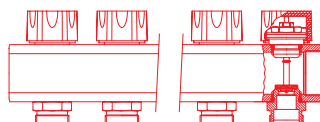

MANIFOLDS FLOW RATE CHART

DISTRIBUTION MANIFOLDS WITH LOCKSHIELDS

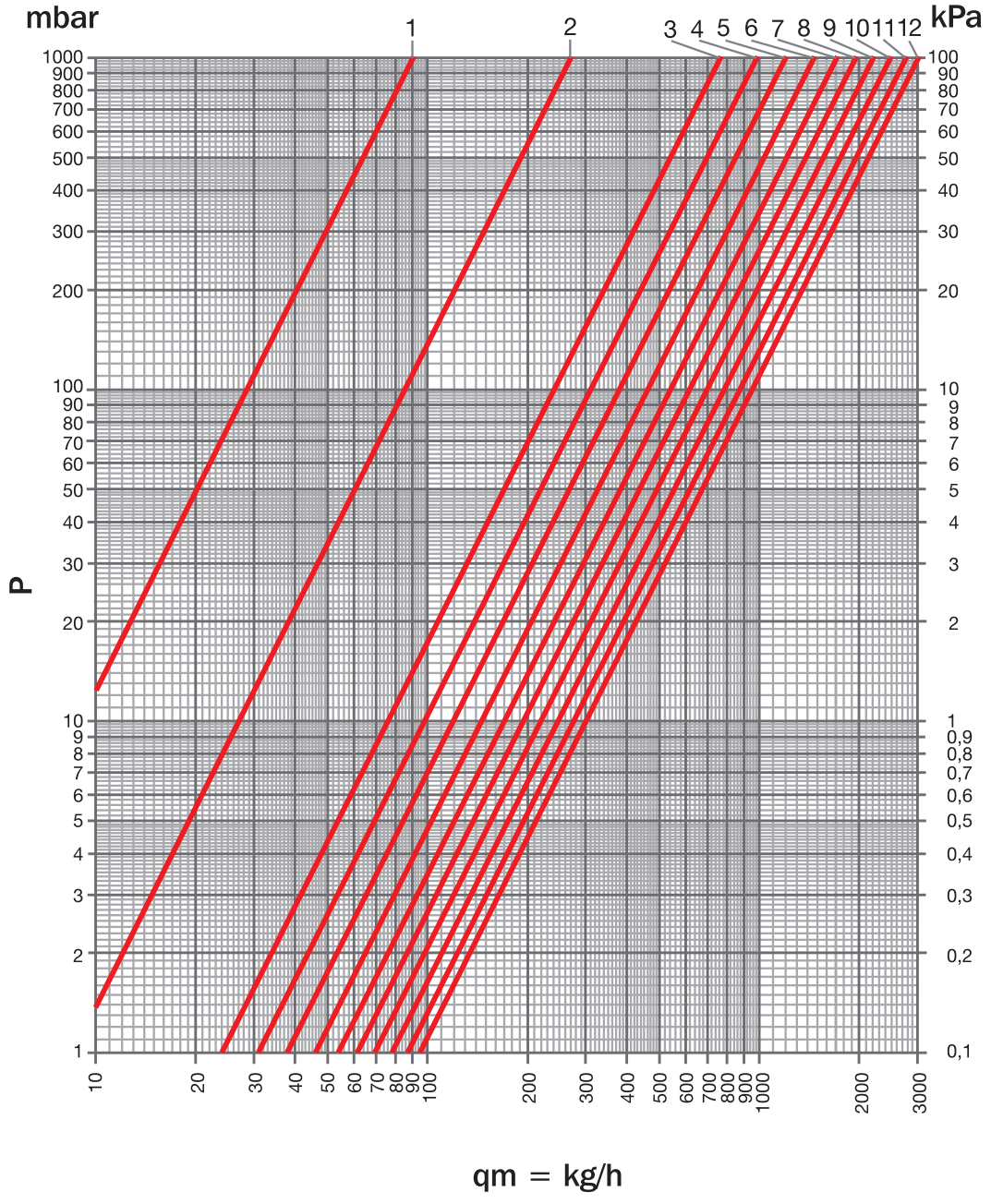

ITEM	SIZE	TURNS N°	DRAIN HOLE	Kvs	POS
CD 449	G 1"	1/2	NO	0,09	1
CD 448	G 1"	1		0,27	2
CD 879	G 1 1/4	1+1/2		0,76	3
		2		0,98	4
CD 880	G 1 1/4	2+1/2		1,20	5
		3	1,46	6	
CD 1449	G 1"	3+1/2	YES	1,70	7
CD 1448	G 1"	4		1,93	8
		4+1/2		2,19	9
CD 881	G 1 1/4	5		2,47	10
		5+1/2		2,75	11
CD 882	G 1 1/4	all open		3,01	12

MAX SUGGESTED FLOW RATE	
G 1"	2400 l/h
G 1 1/4	4200 l/h

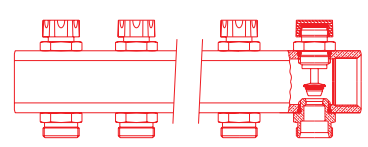

MANIFOLDS FLOW RATE CHART

DISTRIBUTION MANIFOLDS WITH FLOW METER TM

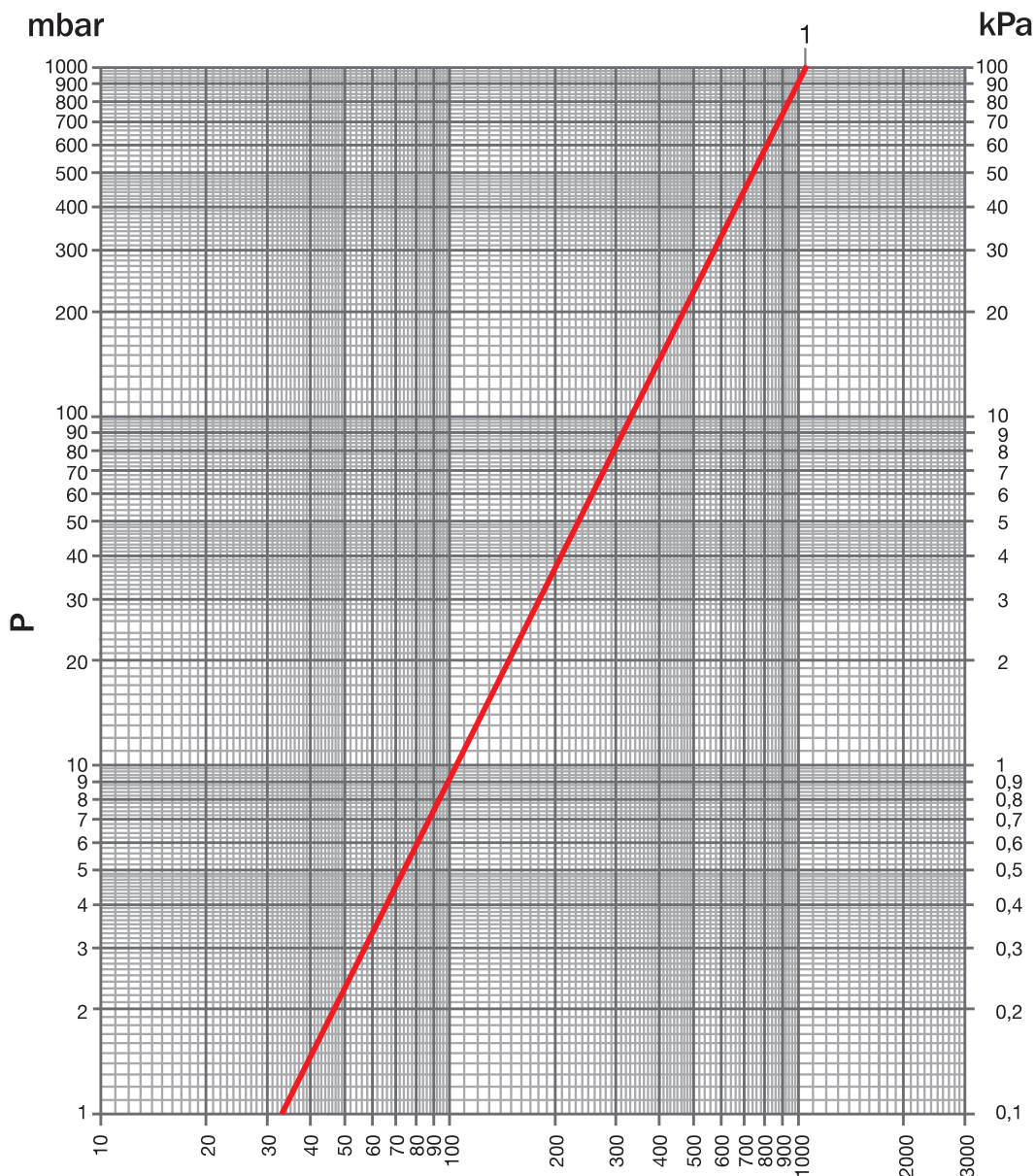

$q_m = \text{kg/h}$

ITEM	SIZE	CD + TM	DRAIN HOLE	Kvs	POS
CD 1474	G 1"	TM 4012	NO	1,05	1
CD 474	G 1"				
CD 868	G 1 1/4"		YES		
CD 867	G 1 1/4"				
CD 3474	G 1"				
CD 2474	G 1"				
CD 870	G 1 1/4"				
CD 869	G 1 1/4"				

MAX SUGGESTED FLOW RATE	
G 1"	1350 l/h
G 1 1/4"	3150 l/h

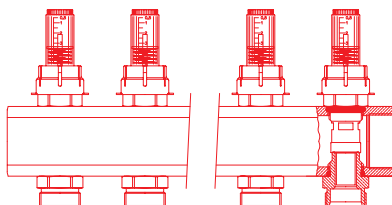

MANIFOLDS FLOW RATE CHART

DISTRIBUTION MANIFOLDS WITH BUILT IN LOCKSHIELDS

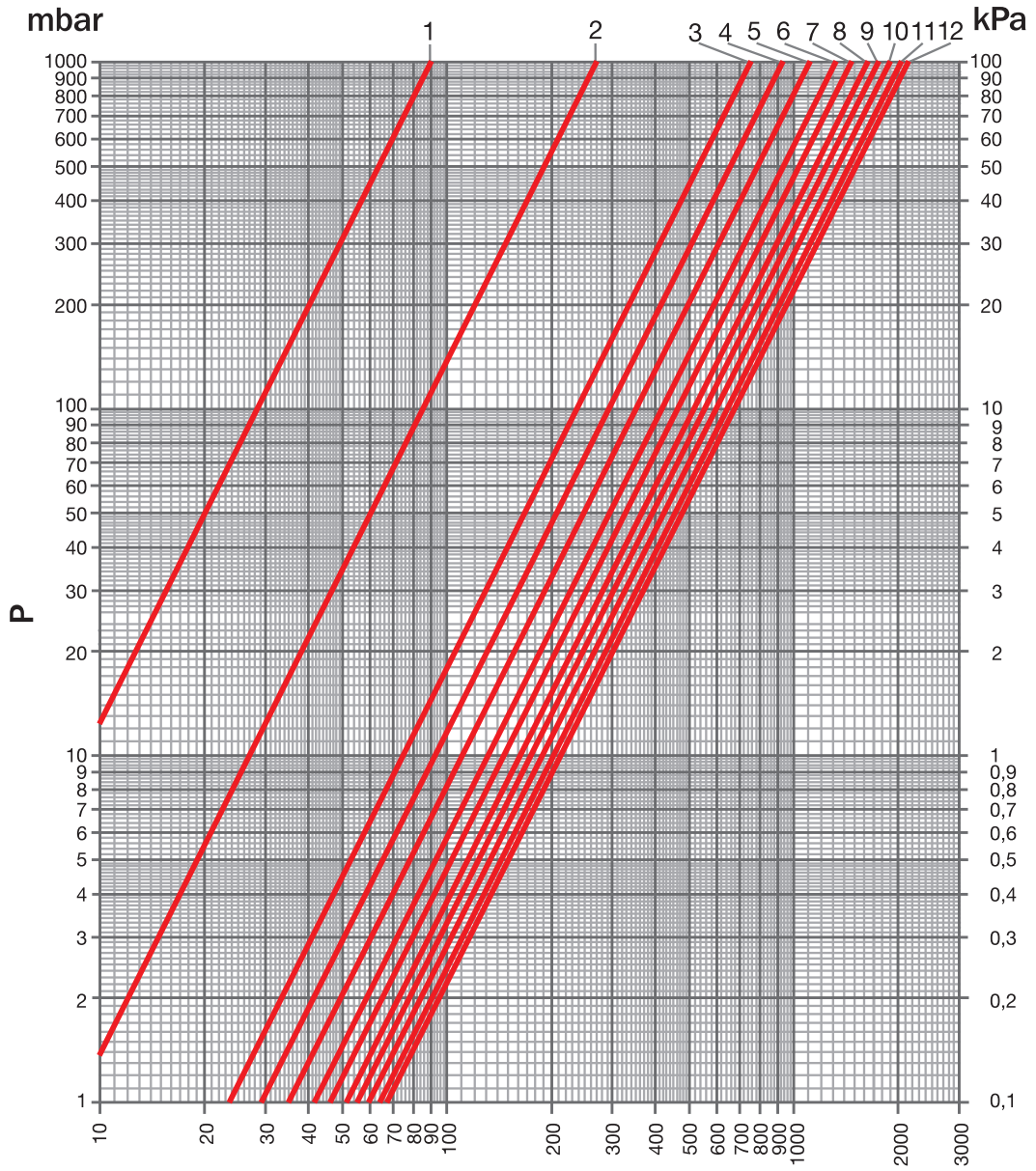

qm = kg/h

ITEM	SIZE	TURNS N°	DRAIN HOLE	Kvs	POS
CD 2465 - CD 2468	G 1"	1/2	NO	0,09	1
CD 2865 - CD 2868	G 1"1/4	1		0,27	2
CD 2467 - CD 2469	G 1"	1+1/2		0,75	3
CD 2867 - CD 2869	G 1"1/4	2	YES	0,93	4
CD 465 - CD 468	G 1"	2+1/2		1,11	5
CD 1865 - CD 1868	G 1"1/4	3		1,31	6
CD 467 - CD 469	G 1"	3+1/2	NO	1,48	7
CD 1867 - CD 1869	G 1"1/4	4		1,62	8
CD 465 - CD 468	G 1"	4+1/2		1,76	9
CD 1865 - CD 1868	G 1"1/4	5	YES	1,90	10
CD 467 - CD 469	G 1"	5+1/2		2,02	11
CD 1867 - CD 1869	G 1"1/4	all open		2,12	12

MAX SUGGESTED FLOW RATE	
G 1"	2400 l/h
G 1"1/4	4200 l/h

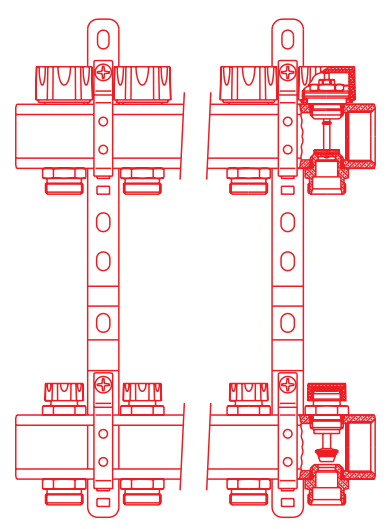

MANIFOLDS FLOW RATE CHART

DISTRIBUTION MANIFOLDS WITH FLOW METER TM

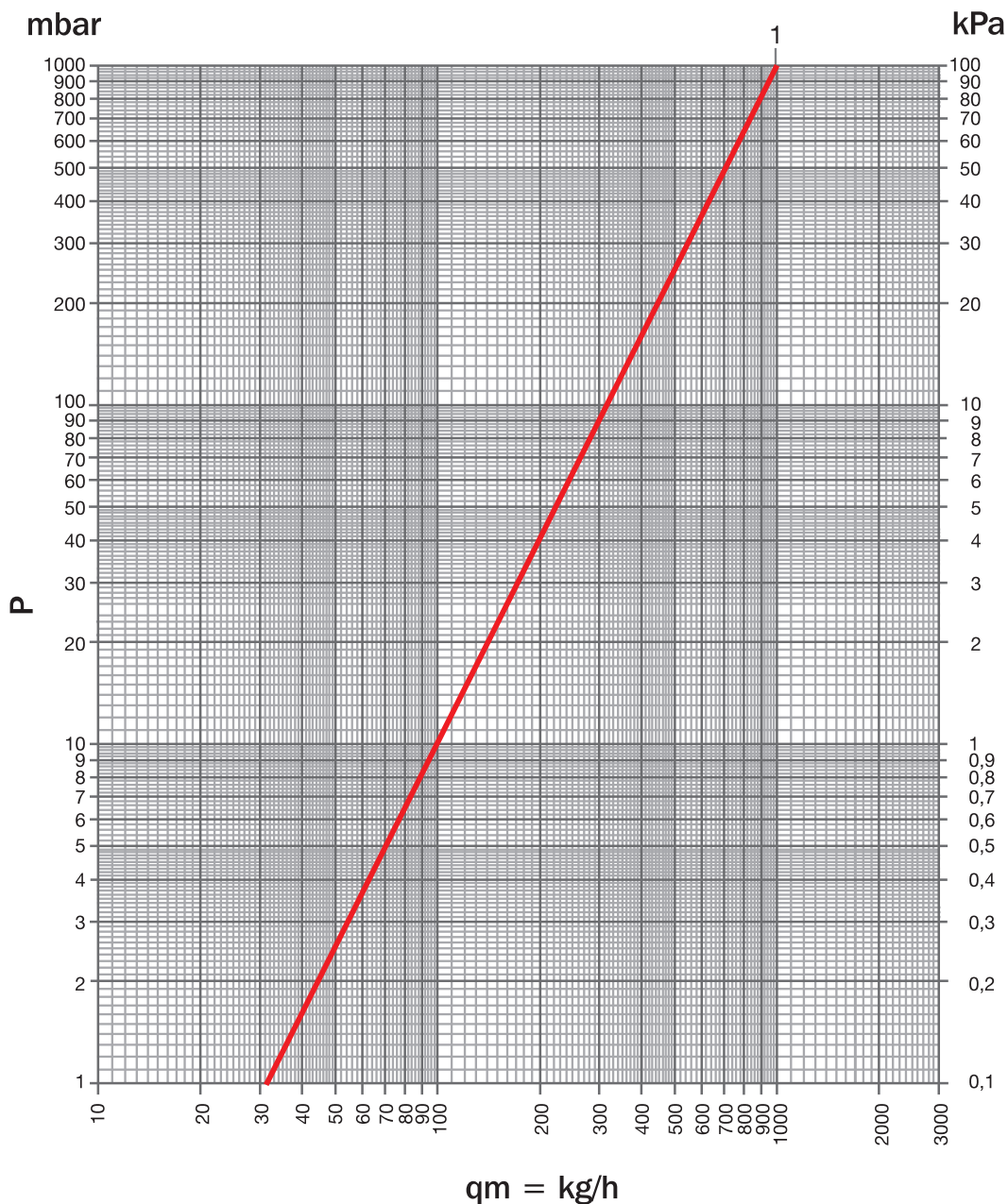

ITEM	SIZE	CD + TM	DRAIN HOLE	Kvs	POS
CD 2478 - CD 2473	G 1"	TM 4012	NO	0,99	1
CD 2878 - CD 2873	G 1 1/4"				
CD 2479 - CD 2477	G 1"		YES		
CD 2879 - CD 2877	G 1 1/4"				
CD 478 - CD 473	G 1"		NO		
CD 1878 - CD 1873	G 1 1/4"				
CD 479 - CD 477	G 1"		YES		
CD 1879 - CD 1877	G 1 1/4"				

MAX SUGGESTED FLOW RATE	
G 1"	1350 l/h
G 1 1/4"	3150 l/h

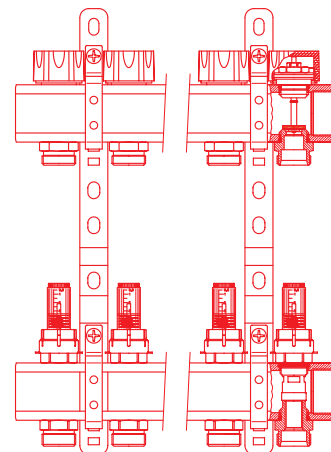



A series of horizontal lines for writing, consisting of 20 evenly spaced lines across the page.



LUXOR®

STAINLESS STEEL DISTRIBUTION MANIFOLDS

2.5 / CX SERIES

CX

STAINLESS STEEL DISTRIBUTION MANIFOLDS



Do only use Luxor manifolds with Luxor accessories with soft o-ring sealing. All of Luxor fittings and accessories for manifolds (such as drain valves, plugs, etc.) are provided with this kind of sealing and do not require any intermedia-

te sealing element (PTFE, hemp, etc.), which could result in cracks.

We recommend to tighten the fittings to a maximum torque of 60 Nm.

TECHNICAL DATA



Max temperature
120 °C



Max pressure
10 bar



Materials
AISI 304



Knob
white ABS
RAL 9016



Stem
AISI 316



Testing
100%

TECHNICAL SPECIFICATIONS WITH FLOW REGULATORS ART. TM 4014



Max temperature
65 °C



Max pressure
6 bar



Working temperature range
0 °C ÷ 100 °C



Room temperature
0 °C ÷ 60 °C



Max relative humidity
80%

TECHNICAL SPECIFICATIONS WITH THERMOELECTRIC HEAD ART. TE

SYSTEM CONNECTIONS

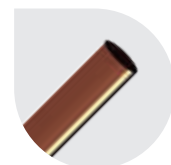

Copper pipe
W 24x19 - TR 91
G 3/4 EK - TR 91/A



Plastic pipe
W 24x19 - TP 95
G 3/4 EK - TP 98

MAIN BODY CONNECTION



G 1"

CENTRE TO CENTRE DISTANCE

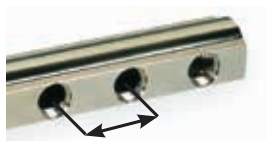

G 1" 50 mm



Multilayer pipe
W 24x19 - TP 97
G 3/4 EK - TP 99

FLOW REGULATORS AND HOLDERS



With regulators and flow meters TM 4012, adjusting and balancing manifolds allow for an immediate verification of the system's balance by reading the flow rate. This adjustment can be locked through a block cap. The glass and the measuring spring can be disassembled for maintenance and cleaned while the system is operating. This kind of manifold must be installed on the inlet.

LOCKSHIELD VALVE



Adjusting and balancing manifolds (lockshield type) feature a double micrometric adjustment with memory of position in case of temporary shutdowns and can be mounted both on inlets and outlets of the system.



CONVERTIBLE HEADWORK

The tightening device on the stem of the manifolds with built-in valves for thermoelectric adjustment can be inspected and replaced while the system is operating. The control stem is in AISI 316 stainless steel and its tightness is ensured by two peroxide cured EPDM o-rings.

All manifolds CX series are 100% checked with an electronically controlled pneumatic test.

The characteristics of the fluid in the system must be compliant with the UNI 8065: 2019 directive.

DISTRIBUTION MANIFOLDS FOR HEATING SYSTEMS WITH INLET REGULATOR / FLOW METERS

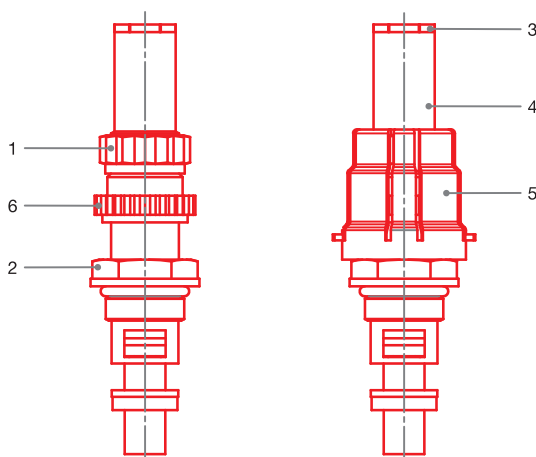

- 1. Adjusting collar
- 2. Fixing collar
- 3. Glass collar
- 4. Glass
- 5. Block cap
- 6. Memory ferrule

ADJUSTMENT INSTRUCTIONS FOR MANIFOLDS WITH INLET REGULATOR/FLOW METERS

BALANCING OF THE HYDRAULIC CIRCUITS

The theoretical flow rate of a hydraulic circuit, assigned by a technician, is given by the adjustment carried out through the regulator/flow meters TM 4014 (code 69000017) assembled on the flow inlet.

The adjustment must be carried out with the valve on the return circuit fully open.

Since the flow rates of each heating ring affect each other, each single heating ring has to be adjusted until the values in litres/minute laid down in the project are satisfactorily reached.

FLOWMETER "MEMORY-STOP" FUNCTION

Blocking system of the opening grade of the flowmeter which allows, once the system is reopened, the stopping of the run at its initial setting (project value).

- 1) Set the Flowmeter control to the design value. The control wheel must be removed during this operation;
- 2) Turn the "Memory stop" ferrule anticlockwise (left-hand thread) to the end of its travel;
- 3) Put the control wheel back on. The individual circuit can be closed by turning the wheel clockwise. By turning it the other way up to the stop it is possible to reopen the circuit to the set design value;

Using the two holes in the control wheel it is possible to seal the Flowmeter so as to prevent tampering with the setting.

Warning: do NOT use any tools to turn/manipulate the Flowmeter, as to do so could stop it working properly.

CLEANING

The glass and the measuring spring can be disassembled for maintenance and cleaned.

This can be done as follows even while the system is operating:

- close the top meter and the screw placed on the return manifold;
- unscrew the glass applying strength on the collar and take it out - be careful not to lose the measuring spring;
- during this operation, a negligible water leakage will appear;
- if necessary, the glass can now be easily cleaned;
- to reassemble, follow the above instructions in reverse.

PRESSURE DROP

The total pressure drop of the heating circuit is made up by various pressure drops: water return valve, pipes and regulator/flow meters.

TM 4014 FLOWMETER 0,5 L

ΔP Pa	ΔP Kpa	Q l/h
10	0,01	8
100	0,1	25
500	0,5	60
1000	1	82
5000	5	185
10000	10	260
20000	20	365
30000	30	450
40000	40	520
50000	50	585
60000	60	640
70000	70	690
80000	80	740
90000	90	785
100000	100	825

FLUID DYNAMIC CHARACTERISTICS

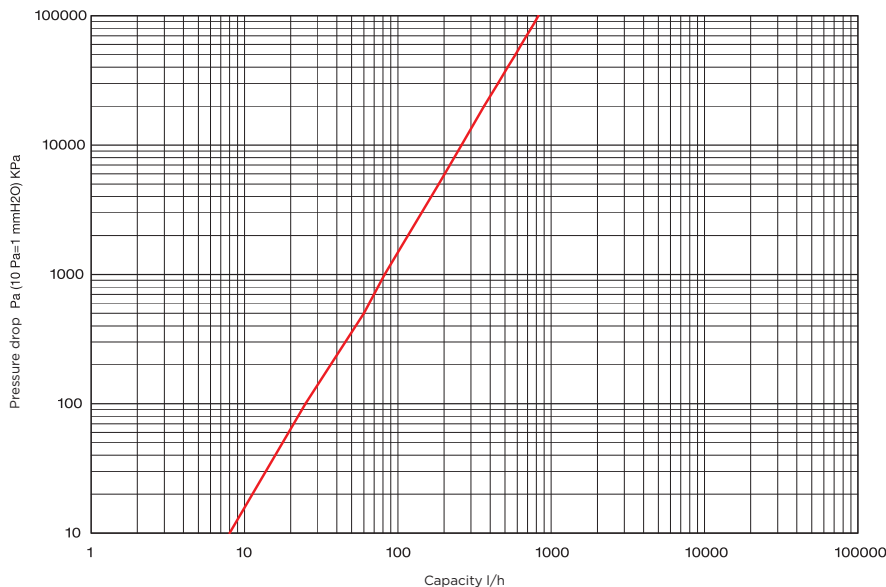

DISTRIBUTION MANIFOLDS FOR HEATING SYSTEMS WITH BUILT-IN LOCKSHIELDS

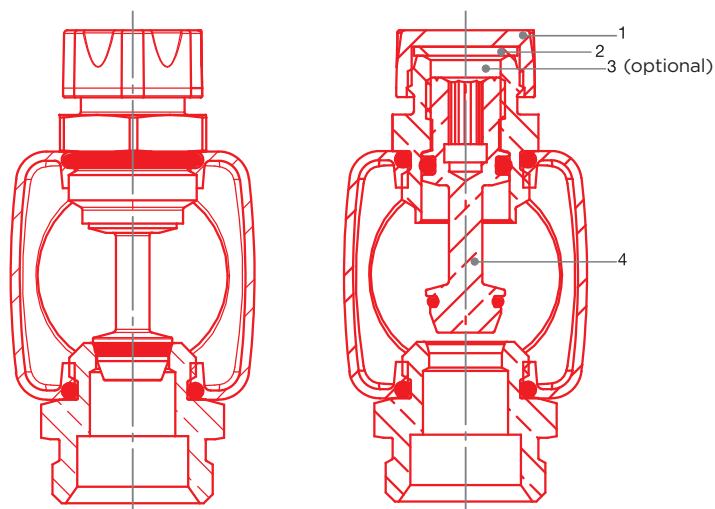

1. ABS plug
2. Gasket
3. Adjusting collar, code 3346656
4. Obturator

ADJUSTMENT INSTRUCTIONS FOR MANIFOLDS WITH LOCKSHIELDS

Unscrew the plug (1). Screw the obturator with a hex key until it reaches the closed position.

After these operations the lockshield is ready to be set.

The relation between the Kv value, the position of the obturator and the corresponding curve, are described in the differential pressure diagram chart. This means that by unscrewing the obturator for a certain number of turns, it is possible to obtain the required Kv value.

EXAMPLE

- Curve n. 1: 1/2 turn of the screw – Kv 0,09
- Curve n. 3: 1+1/2 turn of the screw – Kv 0,76

Using the collar code 3346656 (supplied separately) it is possible to create a mechanical stop of the obturator.

Once the flow rate has been set through the obturator, the regulating collar must be screwed to the obturator.

It is now possible to open and close the obturator without losing the position of the previously set regulation.

In case of water leakage from the screw stem, the sealing assembly can be tightened until the flow comes to a full stop.

Should the leakage continue, the whole sealing assembly can be replaced by following the instructions below while the group is operating.

- Remove the protection cap, the knob, the thermostatic head or the thermoelectric head;
- Unscrew the sealing assembly with a 9mm key blocking the screw body with a 19mm key;
- Replace the part with article code 67980200 screwing it in with a 9mm key;
- Replace the protection cap, the knob, the thermostatic head or the thermoelectric head.

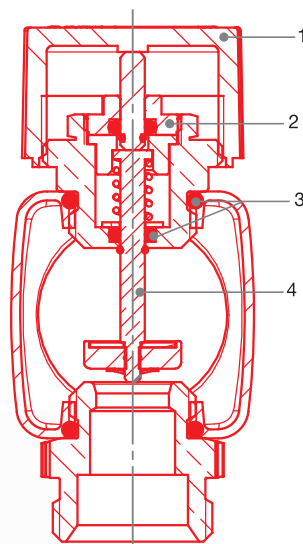

1. ABS plug or manual knob
2. Sealing assembly item 516
3. Gasket
4. Obturator



G 1"

HOW TO CHOOSE THE RIGHT CABINET

G 1" MANIFOLD

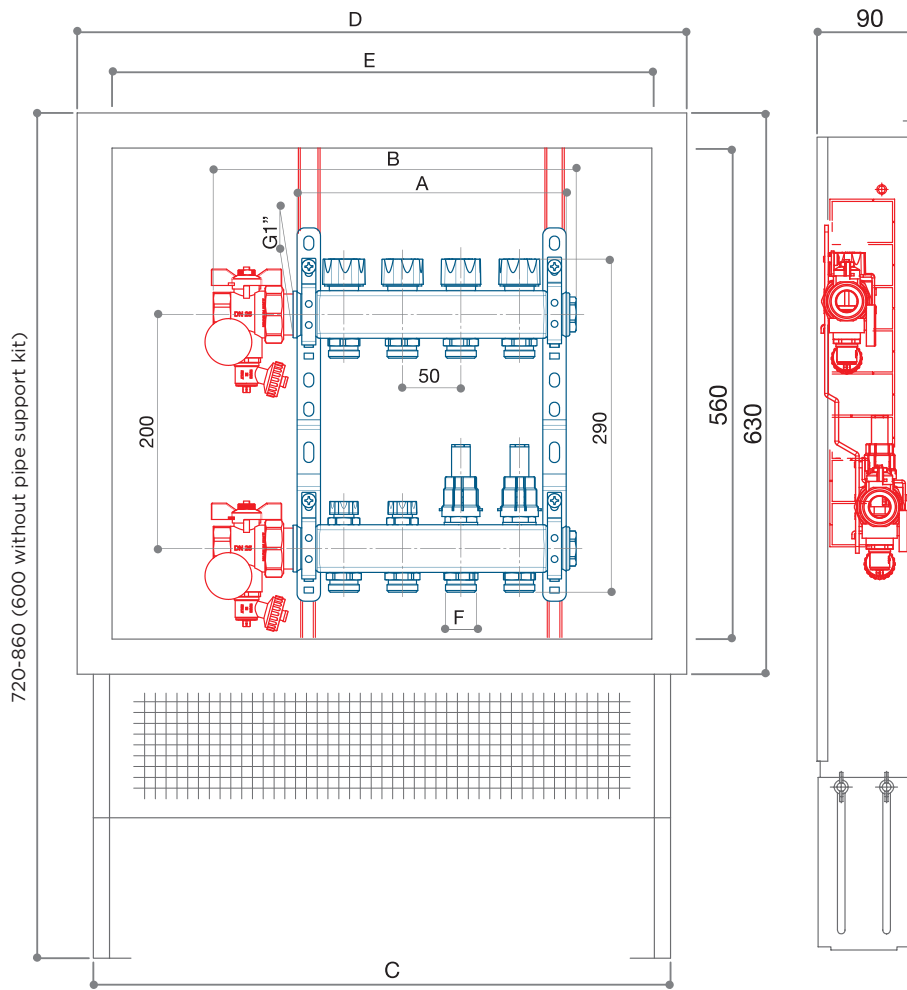

OUTLETS							CABINETS	
	A	B	C	D	E	F	ITEM	CODE
2	130	210						
3	180	260						
4	230	310	500	560	490		CF 490	68561405
5	280	360						
6	330	410						
7	380	460						
8	430	510	700	760	690	W24x19 - G 3/4 EK	CF 490	68561407
9	480	560						
10	530	610						
11	580	660						
12	630	710	850	910	840		CF 490	68561408
13	680	760						
14	730	810						
15	780	860	1000	1060	990		CF 490	68561410
16	830	910						



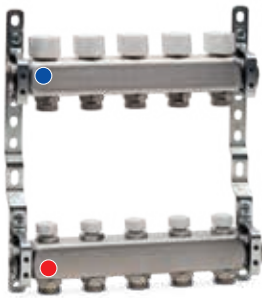



STAINLESS STEEL DISTRIBUTION MANIFOLDS



Pre-assembled distribution manifold consisting of:

- 1 return manifold with built-in valves set for thermoelectric adjustment and protection caps
- 1 inlet manifold with built in lockshields fit for double regulation
- 2 metal brackets.

CX 2465

CODE	SIZE	OUTLETS N°						
15512402X	G 1" x (W24x19)	2	TR 91	TP 95	TP 97	1,331	1	-
15512403X		3	TR 91	TP 95	TP 97	1,756	1	-
15512404X		4	TR 91	TP 95	TP 97	2,166	1	-
15512405X		5	TR 91	TP 95	TP 97	2,552	1	-
15512406X		6	TR 91	TP 95	TP 97	2,998	1	-
15512407X		7	TR 91	TP 95	TP 97	3,384	1	-
15512408X		8	TR 91	TP 95	TP 97	3,782	1	-
15512409X		9	TR 91	TP 95	TP 97	4,108	1	-
15512410X		10	TR 91	TP 95	TP 97	4,602	1	-
15512411X		11	TR 91	TP 95	TP 97	5,008	1	-
15512412X		12	TR 91	TP 95	TP 97	5,438	1	-
15512413X		13	TR 91	TP 95	TP 97	5,832	1	-
15512414X		14	TR 91	TP 95	TP 97	5,914	1	-
15512415X		15	TR 91	TP 95	TP 97	6,303	1	-
15512416X		16	TR 91	TP 95	TP 97	6,692	1	-

CX 2468

CODE	SIZE	OUTLETS N°						
15512702X	G 1" x G 3/4 EK	2	TR 91/A	TP 98	TP 99	1,138	1	-
15512703X		3	TR 91/A	TP 98	TP 99	1,756	1	-
15512704X		4	TR 91/A	TP 98	TP 99	2,166	1	-
15512705X		5	TR 91/A	TP 98	TP 99	2,552	1	-
15512706X		6	TR 91/A	TP 98	TP 99	2,998	1	-
15512707X		7	TR 91/A	TP 98	TP 99	3,384	1	-
15512708X		8	TR 91/A	TP 98	TP 99	3,782	1	-
15512709X		9	TR 91/A	TP 98	TP 99	4,108	1	-
15512710X		10	TR 91/A	TP 98	TP 99	4,602	1	-
15512711X		11	TR 91/A	TP 98	TP 99	5,008	1	-
15512712X		12	TR 91/A	TP 98	TP 99	5,438	1	-
15512713X		13	TR 91/A	TP 98	TP 99	5,832	1	-
15512714X		14	TR 91/A	TP 98	TP 99	6,306	1	-
15512715X		15	TR 91/A	TP 98	TP 99	6,723	1	-
15512716X		16	TR 91/A	TP 98	TP 99	7,140	1	-



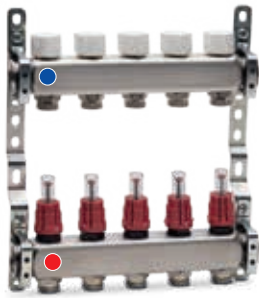

Pre-assembled distribution manifold consisting of:

- 1 return manifold with built-in valves set for thermoelectric adjustment and protection caps
- 1 inlet manifold with regulator/flow meters
- 2 metal brackets.

CX 2478

CODE	SIZE	OUTLETS N°						
15612402X	G 1" x (W24x19)	2	TR 91	TP 95	TP 97	1,276	1	-
15612403X		3	TR 91	TP 95	TP 97	1,666	1	-
15612404X		4	TR 91	TP 95	TP 97	2,040	1	-
15612405X		5	TR 91	TP 95	TP 97	2,412	1	-
15612406X		6	TR 91	TP 95	TP 97	2,804	1	-
15612407X		7	TR 91	TP 95	TP 97	3,160	1	-
15612408X		8	TR 91	TP 95	TP 97	3,528	1	-
15612409X		9	TR 91	TP 95	TP 97	3,856	1	-
15612410X		10	TR 91	TP 95	TP 97	4,280	1	-
15612411X		11	TR 91	TP 95	TP 97	4,652	1	-
15612412X		12	TR 91	TP 95	TP 97	5,042	1	-
15612413X		13	TR 91	TP 95	TP 97	5,424	1	-
15612414X		14	TR 91	TP 95	TP 97	5,525	1	-
15612415X		15	TR 91	TP 95	TP 97	5,886	1	-
15612416X		16	TR 91	TP 95	TP 97	6,247	1	-

CX 2473

CODE	SIZE	OUTLETS N°						
15612702X	G 1" x G 3/4 EK	2	TR 91/A	TP 98	TP 99	1,082	1	-
15612703X		3	TR 91/A	TP 98	TP 99	1,666	1	-
15612704X		4	TR 91/A	TP 98	TP 99	2,040	1	-
15612705X		5	TR 91/A	TP 98	TP 99	2,412	1	-
15612706X		6	TR 91/A	TP 98	TP 99	2,804	1	-
15612707X		7	TR 91/A	TP 98	TP 99	3,160	1	-
15612708X		8	TR 91/A	TP 98	TP 99	3,528	1	-
15612709X		9	TR 91/A	TP 98	TP 99	3,856	1	-
15612710X		10	TR 91/A	TP 98	TP 99	4,280	1	-
15612711X		11	TR 91/A	TP 98	TP 99	4,652	1	-
15612712X		12	TR 91/A	TP 98	TP 99	5,042	1	-
15612713X		13	TR 91/A	TP 98	TP 99	5,424	1	-
15612714X		14	TR 91/A	TP 98	TP 99	5,917	1	-
15612715X		15	TR 91/A	TP 98	TP 99	6,306	1	-
15612716X		16	TR 91/A	TP 98	TP 99	6,695	1	-



Fittings for copper pipe



Fittings for plastic pipe



Fittings for multilayer pipe



Fittings: chapter 7



Accessories: chapter 2.A



Pre-assembled distribution manifold consisting of:

- 1 return manifold with manual screw and aluminium discs for sanitary user identification
- 1 delivery manifold with manual screw and aluminium discs for sanitary user identification
- 2 metal supports.



CX 1000

CODE	SIZE	OUTLETS N°						
15712702X	G 1" x G 3/4 EK	2	TR 91/A	TP 98	TP 99	1,3328	1	-
15712703X		3	TR 91/A	TP 98	TP 99	1,7232	1	-
15712704X		4	TR 91/A	TP 98	TP 99	2,1096	1	-
15712705X		5	TR 91/A	TP 98	TP 99	2,4760	1	-
15712706X		6	TR 91/A	TP 98	TP 99	2,8824	1	-
15712707X		7	TR 91/A	TP 98	TP 99	3,2448	1	-
15712708X		8	TR 91/A	TP 98	TP 99	3,6632	1	-
15712709X		9	TR 91/A	TP 98	TP 99	4,0956	1	-
15712710X		10	TR 91/A	TP 98	TP 99	4,4560	1	-
15712711X		11	TR 91/A	TP 98	TP 99	4,8424	1	-
15712712X		12	TR 91/A	TP 98	TP 99	5,2248	1	-
15712713X		13	TR 91/A	TP 98	TP 99	5,6212	1	-
15712714X		14	TR 91/A	TP 98	TP 99	6,0176	1	-



Pre-assembled distribution manifold with manual valve and aluminium discs for identification of sanitary utilities. Manual air vent valve and fill/drain valve for heating system water.

CX 4123

CODE	SIZE	OUTLETS N°			
17412302X	G 1" x G 3/4 EK	2	0,6394	15	-
17412303X		3	0,8326	12	-
17412304X		4	1,0158	10	-
17412305X		5	1,2190	10	-
17412306X		6	1,4002	8	-
17412307X		7	1,6094	8	-
17412308X		8	1,8256	8	-
17412309X		9	2,0058	8	-
17412310X		10	2,1990	8	-
17412311X		11	2,3902	8	-
17412312X		12	2,5884	8	-



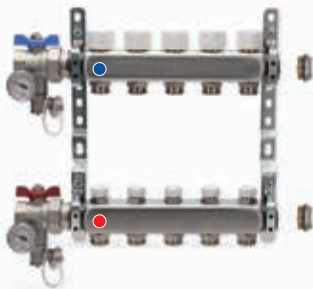



PRE-ASSEMBLED STAINLESS STEEL DISTRIBUTION MANIFOLDS WITH INSTALLATION ACCESSORIES









Pre-assembled distribution manifold consisting of:

- 1 return manifold with built-in valves set for thermoelectric adjustment and manual control knob
- 1 inlet manifold with built-in lockshields fit for double regulation.

CX 2465M

CODE	SIZE	OUTLETS N°						
15512402MX	G 1" x (W24x19)	2	TR 91	TP 95	TP 97	2,658	1	-
15512403MX		3	TR 91	TP 95	TP 97	3,276	1	-
15512404MX		4	TR 91	TP 95	TP 97	3,686	1	-
15512405MX		5	TR 91	TP 95	TP 97	4,072	1	-
15512406MX		6	TR 91	TP 95	TP 97	4,518	1	-
15512407MX		7	TR 91	TP 95	TP 97	4,904	1	-
15512408MX		8	TR 91	TP 95	TP 97	5,302	1	-
15512409MX		9	TR 91	TP 95	TP 97	5,628	1	-
15512410MX		10	TR 91	TP 95	TP 97	6,122	1	-
15512411MX		11	TR 91	TP 95	TP 97	6,528	1	-
15512412MX		12	TR 91	TP 95	TP 97	6,958	1	-
15512413MX		13	TR 91	TP 95	TP 97	7,352	1	-
15512414MX		14	TR 91	TP 95	TP 97	7,313	1	-
15512415MX		15	TR 91	TP 95	TP 97	7,702	1	-
15512416MX		16	TR 91	TP 95	TP 97	8,090	1	-

CX 2468M

CODE	SIZE	OUTLETS N°						
15512702MX	G 1" x G 3/4 EK	2	TR 91/A	TP 98	TP 99	2,658	1	-
15512703MX		3	TR 91/A	TP 98	TP 99	3,276	1	-
15512704MX		4	TR 91/A	TP 98	TP 99	3,686	1	-
15512705MX		5	TR 91/A	TP 98	TP 99	4,072	1	-
15512706MX		6	TR 91/A	TP 98	TP 99	4,518	1	-
15512707MX		7	TR 91/A	TP 98	TP 99	4,904	1	-
15512708MX		8	TR 91/A	TP 98	TP 99	5,302	1	-
15512709MX		9	TR 91/A	TP 98	TP 99	5,628	1	-
15512710MX		10	TR 91/A	TP 98	TP 99	6,122	1	-
15512711MX		11	TR 91/A	TP 98	TP 99	6,528	1	-
15512712MX		12	TR 91/A	TP 98	TP 99	6,958	1	-
15512713MX		13	TR 91/A	TP 98	TP 99	7,352	1	-
15512714MX		14	TR 91/A	TP 98	TP 99	7,705	1	-
15512715MX		15	TR 91/A	TP 98	TP 99	8,122	1	-
15512716 MX		16	TR 91/A	TP 98	TP 99	8,538	1	-



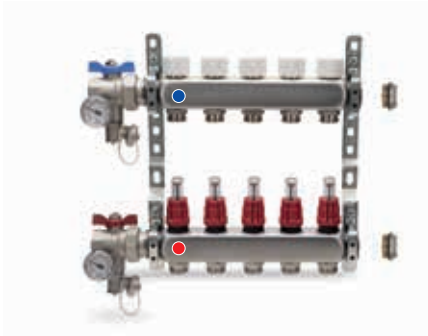













Pre-assembled distribution manifold consisting of:

- 1 return manifold with built-in valves set for thermoelectric adjustment and manual control knob
- 1 inlet manifold with regulator/flow meters.

CX 2478M

CODE	SIZE	OUTLETS N°						
15612402MX	G 1" x (W24x19)	2	TR 91	TP 95	TP 97	2,602	1	-
15612403MX		3	TR 91	TP 95	TP 97	3,186	1	-
15612404MX		4	TR 91	TP 95	TP 97	3,560	1	-
15612405MX		5	TR 91	TP 95	TP 97	3,932	1	-
15612406MX		6	TR 91	TP 95	TP 97	4,324	1	-
15612407MX		7	TR 91	TP 95	TP 97	4,680	1	-
15612408MX		8	TR 91	TP 95	TP 97	5,048	1	-
15612409MX		9	TR 91	TP 95	TP 97	5,376	1	-
15612410MX		10	TR 91	TP 95	TP 97	5,800	1	-
15612411MX		11	TR 91	TP 95	TP 97	6,172	1	-
15612412MX		12	TR 91	TP 95	TP 97	6,562	1	-
15612413MX		13	TR 91	TP 95	TP 97	6,944	1	-
15612414MX		14	TR 91	TP 95	TP 97	6,924	1	-
15612415MX		15	TR 91	TP 95	TP 97	7,285	1	-
15612416MX		16	TR 91	TP 95	TP 97	7,646	1	-

CX 2473M

CODE	SIZE	OUTLETS N°						
15612702MX	G 1" x G 3/4 EK	2	TR 91/A	TP 98	TP 99	2,602	1	-
15612703MX		3	TR 91/A	TP 98	TP 99	3,186	1	-
15612704MX		4	TR 91/A	TP 98	TP 99	3,560	1	-
15612705MX		5	TR 91/A	TP 98	TP 99	3,932	1	-
15612706MX		6	TR 91/A	TP 98	TP 99	4,324	1	-
15612707MX		7	TR 91/A	TP 98	TP 99	4,680	1	-
15612708MX		8	TR 91/A	TP 98	TP 99	5,048	1	-
15612709MX		9	TR 91/A	TP 98	TP 99	5,376	1	-
15612710MX		10	TR 91/A	TP 98	TP 99	5,800	1	-
15612711MX		11	TR 91/A	TP 98	TP 99	6,172	1	-
15612712MX		12	TR 91/A	TP 98	TP 99	6,562	1	-
15612713MX		13	TR 91/A	TP 98	TP 99	6,944	1	-
15612714MX		14	TR 91/A	TP 98	TP 99	7,316	1	-
15612715MX		15	TR 91/A	TP 98	TP 99	7,705	1	-
15612716MX		16	TR 91/A	TP 98	TP 99	8,094	1	-



Fittings for copper pipe



Fittings for plastic pipe



Fittings for multilayer pipe



Fittings: chapter 7



Accessories: chapter 2.A

MULTIPURPOSE WATER INLET BALL VALVE



TECHNICAL DATA



Max temperature

90°C



Max pressure

10 bar



DN

25



Materials

CW617N

CONSTRUCTIVE FEATURES

Multipurpose water inlet ball valves are manufactured in CW617N brass and compatible with Luxor manifolds and components.

Multipurpose water inlet ball valves' pivot pin is installed from the inside. This system, known as "explosion-proof", prevents the pivot pin and its sealing system from escaping, while making external tampering impossible as well. Ball valves feature two elastomeric O-ring seals, chosen for their high resistance to ageing.

FUNCTIONS

Multipurpose ball valves are extremely compact and may be installed on either right or left of the manifold simply by placing the thermometer on the desired side.

These valves are called "multipurpose" because they combine a number of functions in one product:

- **Ball valve:** allowing to intercept the flow to the manifold.
- **Manual air vent valve:** the handle's stem features a manual air vent which may be operated through the drive on the plug of the water inlet/outlet valve. The position of the vent on the upper side of the valve facilitates the complete expulsion of air from the system, thus allowing for optimal operation.
- **Integrated thermometer** for temperature display: may be installed on either side according to the intended use.

BALL VALVE

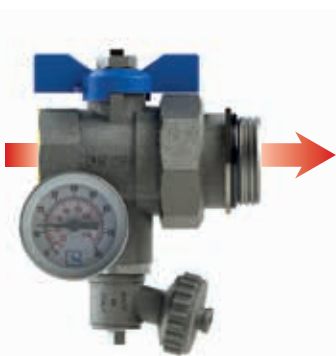

WATER OUTLET VALVE

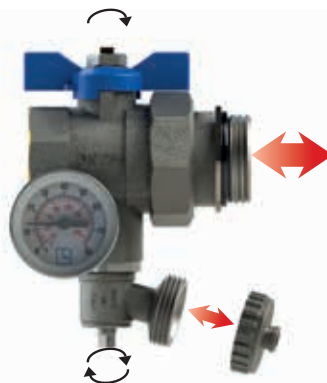

MANUAL AIR VENT VALVE

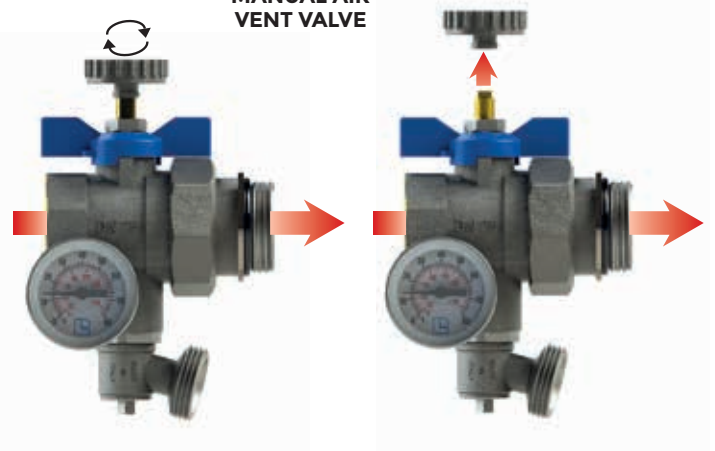

MULTIPURPOSE WATER INLET BALL VALVE

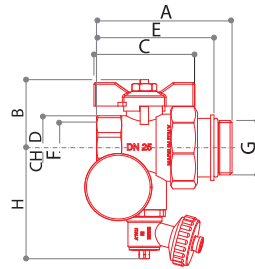

VC 481

Multipurpose water inlet ball valve with manual air vent, blue or red butterfly handle and CR 498 fitting with O-ring for manifold connection, complete with 0°C ÷80°C thermometer.

CODE	SIZE	A	B	C	D	E	F	G	H	L			
68559722B	G 1"	81	41	60	38	70	G 1"	G 1"	70	-	645	4	32
68559722R	G 1"	81	41	60	38	70	G 1"	G 1"	70	-	645	4	32

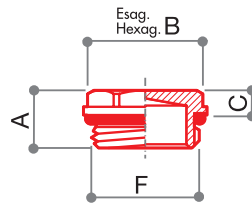

TC 460

Cap with o-ring seal.

CODE	SIZE	PLATED	A	B	C	D	E	F	G	H	L			
68559934N	G 1"	NICKEL	19	27	9	-	-	G 1"	-	-	-	52	50	400

MANIFOLDS FLOW RATE CHART

DISTRIBUTION MANIFOLDS WITH BUILT IN LOCKSHIELDS

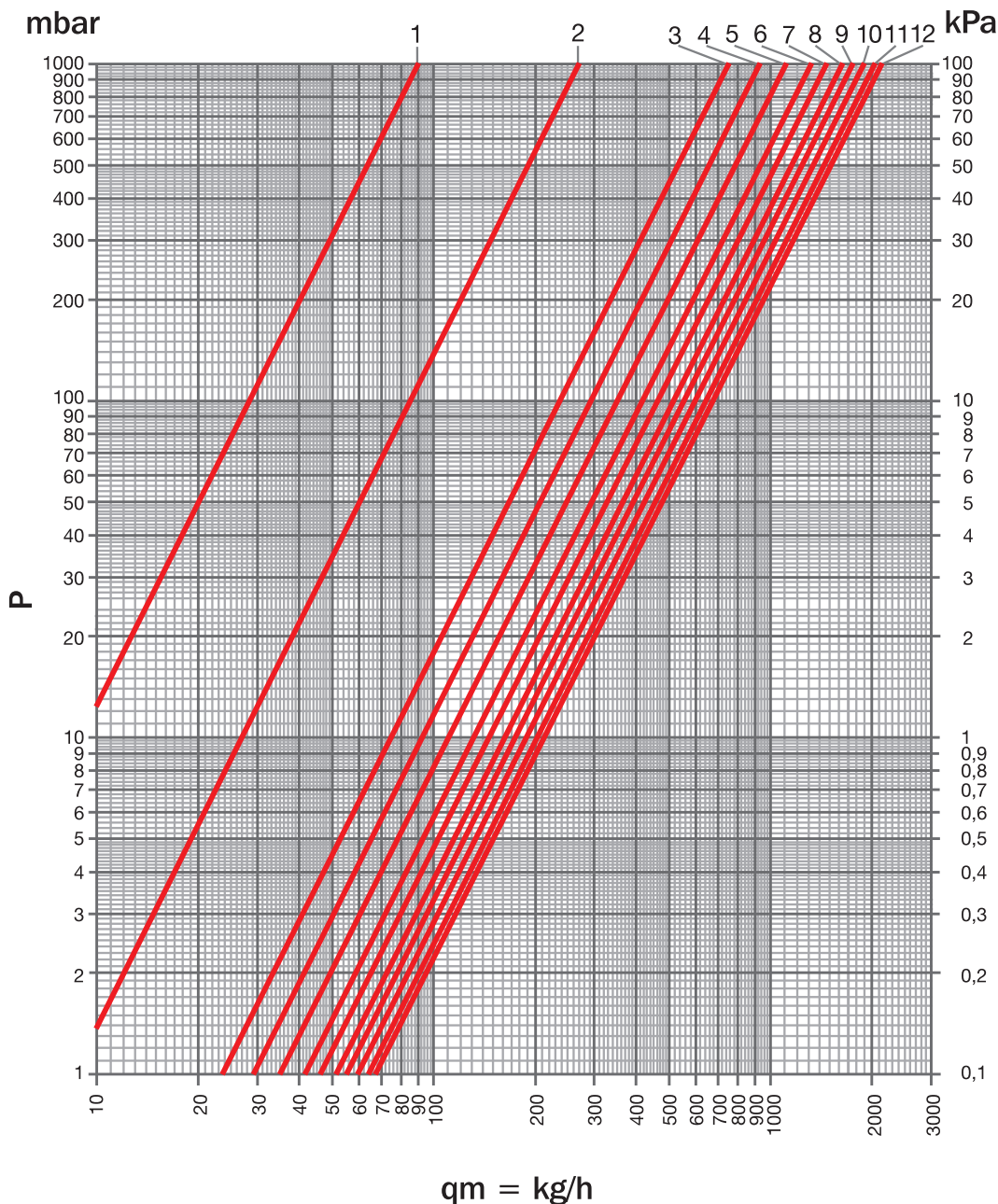

ITEM	SIZE	TURNS N°	Kvs	POS
CX 2468	G 1"	1/2	0,09	1
		1	0,27	2
		1+1/2	0,75	3
		2	0,93	4
		2+1/2	1,11	5
		3	1,31	6
		3+1/2	1,48	7
		4	1,62	8
		4+1/2	1,76	9
		5	1,90	10
		5+1/2	2,02	11
		all open	2,12	12

MAX SUGGESTED FLOW RATE
2860 l/h

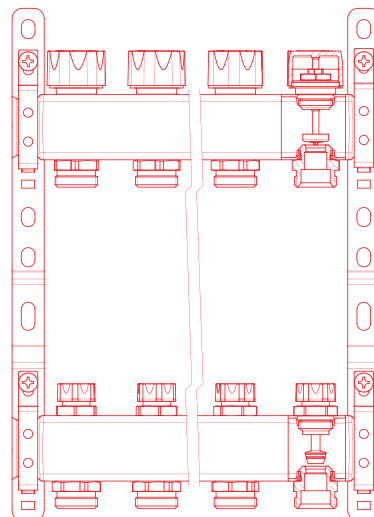

MANIFOLDS FLOW RATE CHART

DISTRIBUTION MANIFOLDS WITH FLOW METER TM

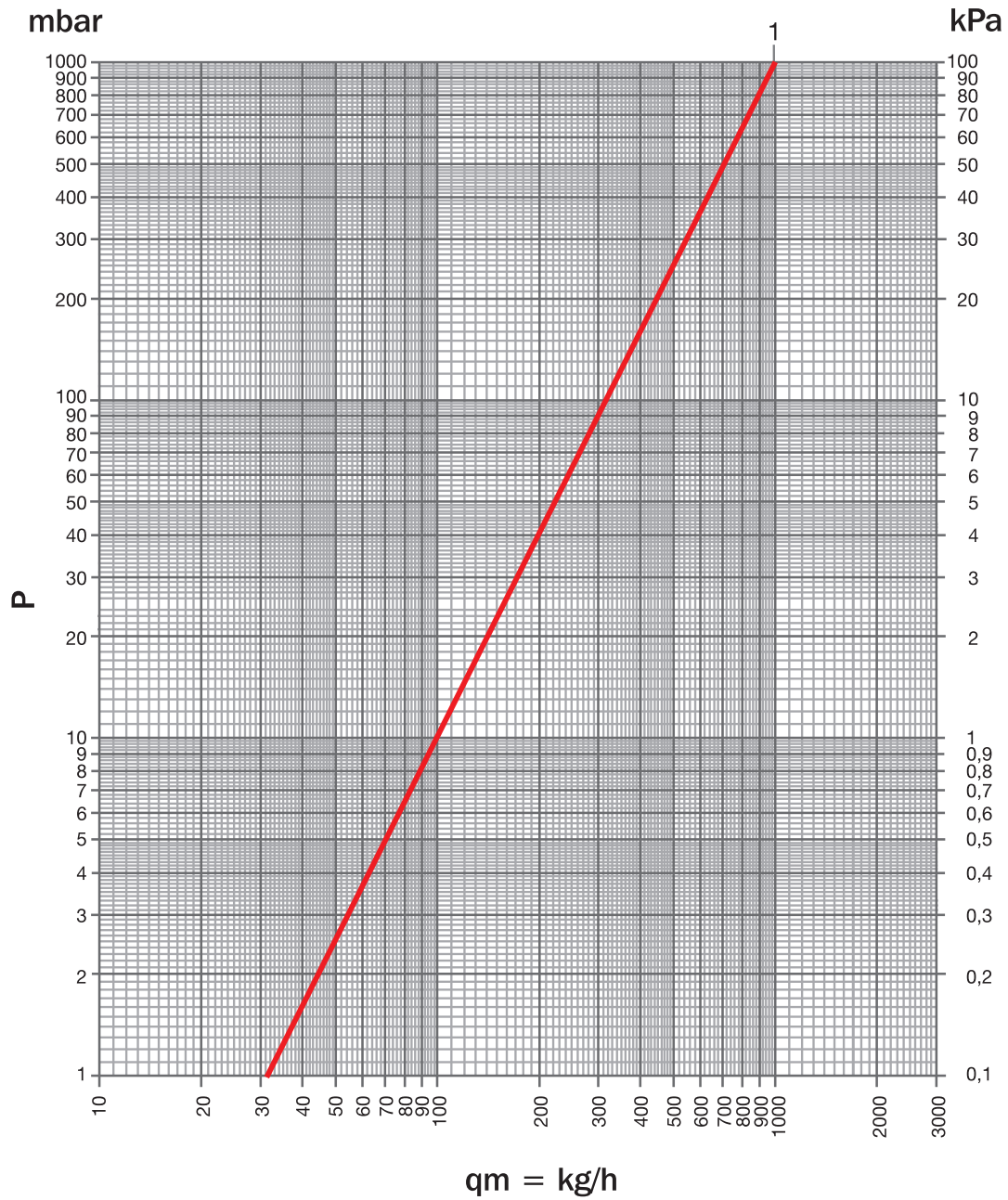

ITEM	SIZE	CX + TM	Kvs	POS
CX 2473	G 1"	TM 4014	0,99	1

MAX SUGGESTED FLOW RATE
2450 l/h

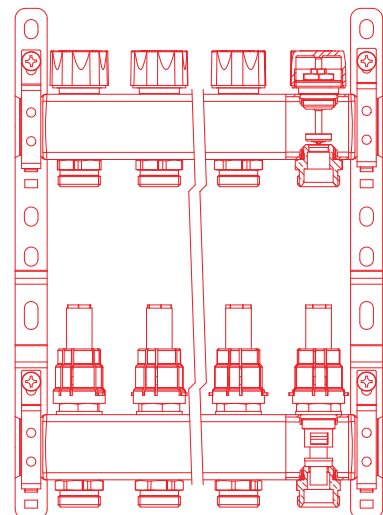



LUXOR®

MANIFOLDS

2.A / ACCESSORIES

THERMOSTATIC HEADS

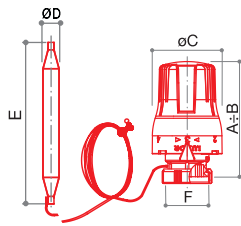

TT 3051

Thermostatic head for underfloor heating with remote probe. Temperature range 20 °C÷65 °C. Standard length of capillary 2 m.

CODE	SIZE	open		closed		D	E	F	G	H	L	Weight	Packing	Volume
		A	B	C	B									
69100005	M30x1,5	80	75	47	11	110	M30x1,5	-	-	-	146	1	32	

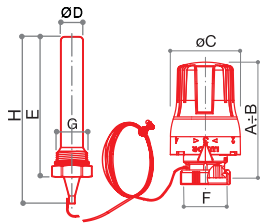

TT 3061

Thermostatic head for underfloor heating with G1/2 M housing to connect remote probe. Temperature range 20 °C÷65 °C. Standard length of capillary 2 m.

CODE	SIZE	open		closed		D	E	F	G	H	L	Weight	Packing	Volume
		A	B	C	B									
69100006	M30x1,5	80	75	47	15	95	M30x1,5	G 1/2	110	-	232	1	32	

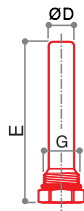

PS 540

Housing for probe.

CODE	SIZE	A	B	C	D	E	F	G	H	L	Weight	Packing	Volume
9446950	G 1/2	-	-	-	15	95	-	G 1/2	-	-	92	20	160



DT 242

Probe fixing device for art. TT 3051.

CODE	SIZE	Weight	Packing	Volume
69010500	-	30	20	160

ACCESSORIES FOR DISTRIBUTION MANIFOLDS

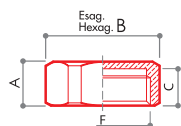

TC 430

End cap with EPDM flat gasket.



*In compliance with D.M.174/2004

CODE	SIZE	A	B	C	D	E	F	G	H	L			
68502701	G 3/4	13	30	11	-	-	G 3/4	-	-	-	37	100	800
68503401	G 1"	15	37	12	-	-	G 1"	-	-	-	60	50	400

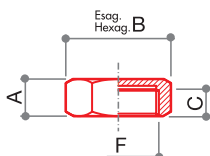

TC 450

Lateral end cap with flat gasket.

CODE	SIZE	FINISH	A	B	C	D	E	F	G	H	L			
68552419	(W24x19)	YELLOW	11	27	8	-	-	W24x19	-	-	-	25	100	800
68552419N	(W24x19)	NICKEL PLATED	11	27	8	-	-	W24x19	-	-	-	25	100	800

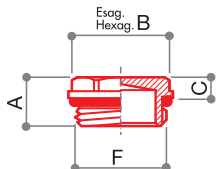

TC 460

End cap with o-ring.

CODE	SIZE	FINISH	A	B	C	D	E	F	G	H	L			
68559917	G 3/8	YELLOW	13	20	8	-	-	G 3/8	-	-	-	20	200	1600
68559921	G 1/2	YELLOW	13	22	7	-	-	G 1/2	-	-	-	20	100	800
68559927	G 3/4	YELLOW	14	25	7	-	-	G 3/4	-	-	-	32	100	800
68559934	G 1"	YELLOW	19	27	9	-	-	G 1"	-	-	-	52	50	400
68559942	G 1" 1/4	YELLOW	25	38	12	-	-	G 1" 1/4	-	-	-	94	30	240
68559917N	G 3/8	NICKEL PLATED	13	20	8	-	-	G 3/8	-	-	-	20	200	1600
68559921N	G 1/2	NICKEL PLATED	13	22	7	-	-	G 1/2	-	-	-	20	100	800
68559927N	G 3/4	NICKEL PLATED	14	25	7	-	-	G 3/4	-	-	-	32	100	800
68559934N	G 1"	NICKEL PLATED	19	27	9	-	-	G 1"	-	-	-	52	50	400
68559942N	G 1" 1/4	NICKEL PLATED	25	38	12	-	-	G 1" 1/4	-	-	-	94	30	240

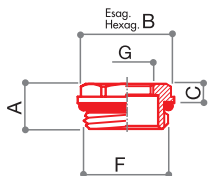



TC 462

Cap with adapter and o-ring.

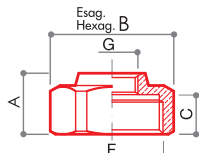
CODE	SIZE	FINISH	A	B	C	D	E	F	G	H	L			
68559901	G 3/4 x G 3/8	YELLOW	14	25	8	-	-	G 3/4	G 3/8	-	-	31	100	800
68559905	G 3/4 x G 1/2	YELLOW	14	25	8	-	-	G 3/4	G 1/2	-	-	23	100	800
68559902	G 1" x G 3/8	YELLOW	19	27	10	-	-	G 1"	G 3/8	-	-	60	50	400
68559903	G 1" x G 1/2	YELLOW	19	27	10	-	-	G 1"	G 1/2	-	-	56	50	400
68559904	G 1" x G 3/4	YELLOW	19	27	10	-	-	G 1"	G 3/4	-	-	58	50	400
68559908	G 1" 1/4 x G 1/2	YELLOW	24	38	11	-	-	G 1" 1/4	G 1/2	-	-	136	30	240
68559909	G 1" 1/4 x G 3/4	YELLOW	24	38	11	-	-	G 1" 1/4	G 3/4	-	-	116	30	240
68559910	G 1" 1/4 x G 1"	YELLOW	24	38	11	-	-	G 1" 1/4	G 1"	-	-	82	30	240
68559901N	G 3/4 x G 3/8	NICKEL PLATED	14	25	8	-	-	G 3/4	G 3/8	-	-	31	100	800
68559905N	G 3/4 x G 1/2	NICKEL PLATED	14	25	8	-	-	G 3/4	G 1/2	-	-	23	100	800
68559902N	G 1" x G 3/8	NICKEL PLATED	19	27	10	-	-	G 1"	G 3/8	-	-	60	50	400
68559903N	G 1" x G 1/2	NICKEL PLATED	19	27	10	-	-	G 1"	G 1/2	-	-	56	50	400
68559904N	G 1" x G 3/4	NICKEL PLATED	19	27	10	-	-	G 1"	G 3/4	-	-	58	50	400
68559908N	G 1" 1/4 x G 1/2	NICKEL PLATED	24	38	11	-	-	G 1" 1/4	G 1/2	-	-	136	30	240
68559909N	G 1" 1/4 x G 3/4	NICKEL PLATED	24	38	11	-	-	G 1" 1/4	G 3/4	-	-	116	30	240
68559910N	G 1" 1/4 x G 1"	NICKEL PLATED	24	38	11	-	-	G 1" 1/4	G 1"	-	-	82	30	240



**TC 435**

End cap with adapter.

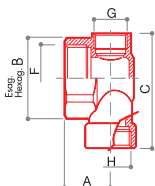
CODE	SIZE	A	B	C	D	E	F	G	H	L			
68502702	G 3/4 x G 3/8	17	31	11,5	-	-	G 3/4	G 3/8	-	-	50	100	800
68503402	G 1" x G 3/8	21	37	13	-	-	G 1"	G 3/8	-	-	66	50	400
68503406	G 1" x G 1/2	21	37	13	-	-	G 1"	G 1/2	-	-	64	50	400



**TC 440**

Terminal with female connections.

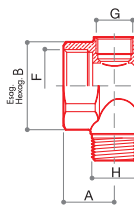
CODE	SIZE	A	B	C	D	E	F	G	H	L			
68502708	G 3/4xG 1/2xG 1/2	33	-	41	-	-	G 3/4	G 1/2	G 1/2	-	140	25	200
68503408	G 1"xG 3/8xG 1/2	23,5	37	58	-	-	G 1"	G 3/8	G 1/2	-	133	25	200

**TC 445**

Terminal with female 3/8 (for air vent valve) male 1/2 (for water drain valve) connections.

CODE	SIZE	A	B	C	D	E	F	G	H	L			
68502705	G 3/4	23,5	37	-	-	-	G 3/4	G 3/8	G 1/2	-	158	25	200
68503405	G 1"	23,5	37	-	-	-	G 1"	G 3/8	G 1/2	-	118	25	200

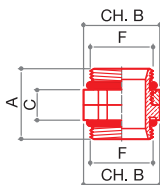

**TC 465**

M-M locknut union fitting with o-rings for manifold CD series.

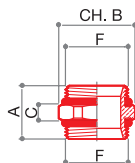
CODE	SIZE	FINISH	A	B	C	D	E	F	G	H	L			
68559635	G 1" x G 1"	YELLOW	37	37	16	-	-	G 1"	-	-	-	121	15	120
68559642	G 1"1/4 x G 1"1/4	YELLOW	45	48	20	-	-	G 1"1/4	-	-	-	245	10	80
68559635N	G 1" x G 1"	NICKEL PLATED	37	37	16	-	-	G 1"	-	-	-	121	15	120
68559642N	G 1"1/4 x G 1"1/4	NICKEL PLATED	45	48	20	-	-	G 1"1/4	-	-	-	245	10	80

**TC 464**

M-M union fitting with o-rings.

CODE	SIZE	FINISH	A	B	C	D	E	F	G	H	L			
68559827	G 3/4 x G 3/4	YELLOW	27	30	7	-	-	G 3/4	-	-	-	66	80	640
68559834	G 1" x G 1"	YELLOW	28	37	8	-	-	G 1"	-	-	-	85	50	400
68559842	G 1"1/4 x G 1"1/4	YELLOW	34	48	10	-	-	G 1"1/4	-	-	-	153	20	160
68559827N	G 3/4 x G 3/4	NICKEL PLATED	27	30	7	-	-	G 3/4	-	-	-	66	80	640
68559834N	G 1" x G 1"	NICKEL PLATED	28	37	8	-	-	G 1"	-	-	-	85	50	400
68559842N	G 1"1/4 x G 1"1/4	NICKEL PLATED	34	48	10	-	-	G 1"1/4	-	-	-	153	20	160

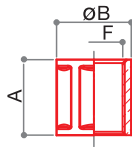

RD 901

Straight F-F union fitting.

CODE	SIZE	A	B	C	D	E	F	G	H	L			
7146770N	G 3/4	33	32	-	-	-	G 3/4	-	-	-	62	30	240
7146772N	G 1"	33	41	-	-	-	G 1"	-	-	-	93	20	160

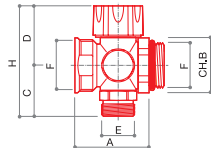

CD 1466/1

One outlet manifold with built-in valve set for electrothermal adjustment and protection cap.

CODE	SIZE	A	B	C	D	E	F	G	H	L			
15112401N	G 1" x (W24x19)	54	37	37	43	W24x19	G 1"	G 1/2	80	-	322	2	64

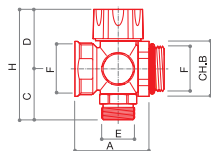

CD 1446/1

One outlet manifold with built-in valve set for electrothermal adjustment and protection cap.

CODE	SIZE	A	B	C	D	E	F	G	H	L			
15112701N	G 1" x G 3/4 EK	54	37	37	43	G 3/4 EK	G 1"	G 1/2	80	-	333	2	64

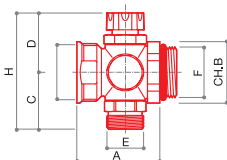

CD 449/1

One outlet manifold with built-in lockshield.

CODE	SIZE	A	B	C	D	E	F	G	H	L			
15212401N	G 1" x (W24x19)	54	37	37	39	W24x19	G 1"	G 1/2	76	-	310	2	64

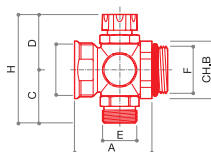



CD 448/1

One outlet manifold with built-in lockshield.

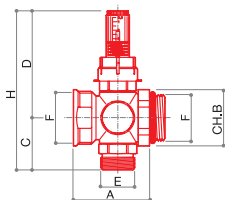
CODE	SIZE	A	B	C	D	E	F	G	H	L			
15212701N	G 1" x G 3/4 EK	54	37	37	39	G 3/4 EK	G 1"	G 1/2	76	-	321	2	64



**CD 1474/1**

One outlet manifold with regulator/
flow meter.

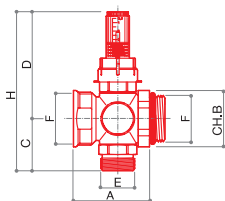
CODE	SIZE	A	B	C	D	E	F	G	H	L			
15252401N	G 1" x (W24x19)	54	37	37	76	W24x19	G 1"	G 1/2	113	-	298	2	64

**CD 474/1**

One outlet manifold with regulator/
flow meter.



CODE	SIZE	A	B	C	D	E	F	G	H	L			
15252701N	G 1" x G 3/4 EK	54	37	37	76	G 3/4 EK	G 1"	G 1/2	113	-	326	2	64

**KC 650**

Kit for manifold CD series consisting of:

- n. 1 angle ball valve with blue handle
- n. 1 angle ball valve with red handle
- n. 2 seal fittings with swivel nut
- n. 2 manual air vent valves
- n. 2 water drain valves
- n. 2 thermometers
- n. 2 lateral end caps.



***ARTICLE DISCONTINUED.**

CODE	SIZE			
68559754	G 1"	1694	1	8
68559762*	G 1"1/4	2992	1	8

**KC 652**

Kit for manifold CD series consisting of:

- n. 1 angle ball valve with blue handle
- n. 1 angle ball valve with red handle
- n. 2 seal fittings with swivel nut
- n. 2 manual air vent valves
- n. 2 water drain valves
- n. 2 thermometers
- n. 2 lateral end caps.

CODE	SIZE			
68559758	G 1"	2112	1	8
68559766	G 1"1/4	2460	1	8

**KC 651**

Kit for manifold CD series consisting of:

- n. 1 angle ball valve with blue handle
- n. 1 angle ball valve with red handle
- n. 2 seal fittings with swivel nut
- n. 2 automatic air vent valves
- n. 2 water drain valves
- n. 2 thermometers
- n. 2 lateral end caps.

***ARTICLE DISCONTINUED.**

CODE	SIZE			
68559756	G 1"	1996	1	8
68559764*	G 1"1/4	3294	1	8

**KC 653**

Kit for manifold CD series consisting of:

- n. 1 angle ball valve with blue handle
- n. 1 angle ball valve with red handle
- n. 2 seal fittings with swivel nut
- n. 2 automatic air vent valves
- n. 2 water drain valves
- n. 2 thermometers
- n. 2 lateral end caps.

CODE	SIZE			
68559760	G 1"	2414	1	8
68559768	G 1"1/4	2762	1	8

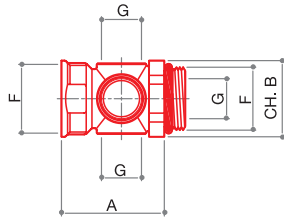

CR 489

Soft seal fitting with locknut for ball valve with 3 connections.

CODE	SIZE	A	B	C	D	E	F	G	H	L			
68503425	G 1" x G 1/2	54	37	-	-	-	G 1"	G 1/2	-	-	187	16	128

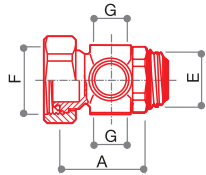

CR 491

Soft seal swivel nut fitting for ball valve with 3 connections.

CODE	SIZE	A	B	C	D	E	F	G	H	L			
68559781	G 1" x G 1/2	53	-	-	-	G 1"	G 1"1/4	G 1/2	-	-	230	16	128
68559785	G 1"1/4 x G 1/2	66	-	-	-	G 1"1/4	G 1"1/2	G 1/2	-	-	382	8	64

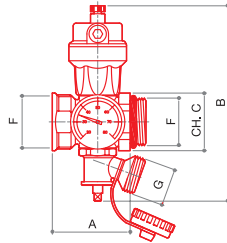

CR 490

Soft seal fitting with locknut for ball valve with adjustable thermometer, automatic air vent valve and adjustable water drain tap.

CODE	SIZE	A	B	C	D	E	F	G	H	L			
68503430	G 1"	54	136	37	-	-	G 1"	G 3/4	-	-	530	4	32

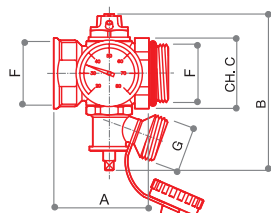

CR 492

Soft seal fitting with locknut for ball valve with adjustable thermometer, manual air vent valve and adjustable water drain tap.

CODE	SIZE	A	B	C	D	E	F	G	H	L			
68503434	G 1"	54	90	37	-	-	G 1"	G 3/4	-	-	379	4	32

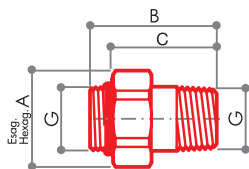



RD 458

Three pieces M-M union fitting with o-ring.

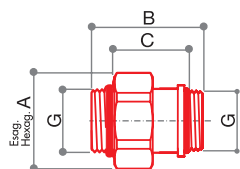
CODE	SIZE	A	B	C	D	E	F	G	H	L			
68992700N	G 3/4	37	52	42	-	-	-	G 3/4	-	-	168	20	160
68993400N	G 1"	47	54	45	-	-	-	G 1"	-	-	262	15	120



**RD 455**

Three pieces M-M union fitting with o-ring.

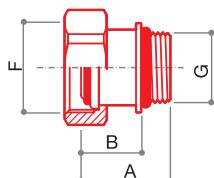
CODE	SIZE	A	B	C	D	E	F	G	H	L			
68992701N	G 3/4	37	48	29	-	-	-	G 3/4	-	-	120	20	160
68993401N	G 1"	46	48	28	-	-	-	G 1"	-	-	238	15	120



**CR 498**

Nickel plated brass nut and fitting with o-ring to connect valves to distribution manifolds.

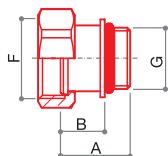
CODE	SIZE	A	B	C	D	E	F	G	H	L			
67901700	DN 10 3/8	26	18	-	-	-	G 5/8	G 3/8	-	-	60	50	400
67902100	DN 15 1/2	26	18	-	-	-	G 3/4	G 1/2	-	-	71	50	400
67902700	DN 20 3/4	33	23	-	-	-	G 1"	G 3/4	-	-	120	20	160
67903400	DN 25 1"	36	25	-	-	-	G 1 1/4	G 1"	-	-	220	15	120
67904200	DN 32 1 1/4	41	35	-	-	-	G 1 1/2	G 1 1/4	-	-	240	10	80



**CR 498/A**

Nickel-plated nut and fitting with flat gasket.

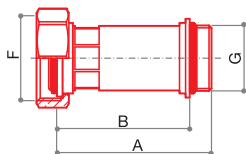
CODE	SIZE	A	B	C	D	E	F	G	H	L			
67922100	DN 15 1/2	23	15	-	-	-	G 3/4	G 1/2	-	-	68	50	400
67922700	DN 20 3/4	29,5	19,5	-	-	-	G 1"	G 3/4	-	-	104	20	160
67924200	DN 32 1 1/4	36	22,5	-	-	-	G 1 1/2	G 1 1/4	-	-	217	10	80



**CR 498/B**

Fitting CR 498 increased by 50 mm.

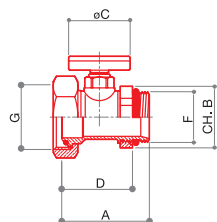
CODE	SIZE	A	B	C	D	E	F	G	H	L			
67913400	DN 25 1"	77	66	-	-	-	G 1 1/4	G 1"	-	-	245	10	80

**CR 499**

Nickel-plated fitting with swivel nut, locknut, o-ring and thermometer to connect ball valves to distribution manifold CD series.

CODE	SIZE	A	B	C	D	E	F	G	H	L			
68503428	G 1"	57	37	40	46	-	G 1"	G 1 1/4	-	-	270	8	64
68504228	G 1 1/4	78	48	40	66	-	G 1 1/4	G 1 1/2	-	-	496	4	32

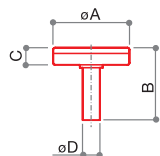

RT 488
Thermometer.

CODE	SIZE	A	B	C	D	E	F	G	H	L			
68559854	-	40	42	10	9	-	-	-	-	-	28	15	120

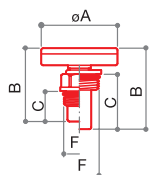

RT 487
Thermometer with housing.

CODE	SIZE	A	B	C	D	E	F	G	H	L			
68559851	G 3/8	40	40	16	-	-	G 3/8	-	-	-	56	10	80
68559852	G 1/2	40	43	29	-	-	G 1/2	-	-	-	56	10	80

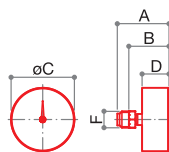

RTA 489
Axial thermometer with fitting and check valve.

CODE	SIZE	A	B	C	D	E	F	G	H	L			
68559855	G 1/2	65	51	80	34	-	G 1/2	-	-	-	155	1	50

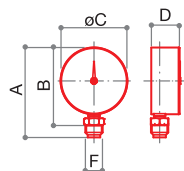

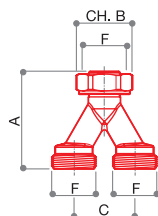

RTR 490
Radial thermometer with fitting and check valve.

CODE	SIZE	A	B	C	D	E	F	G	H	L			
68559856	G 1/2	108	94	80	34	-	G 1/2	-	-	-	152	1	50

**SD 484**

Nickel plated splitter.

CODE	SIZE	A	B	C	D	E	F	G	H	L			
68502419	(W24x19)	58	27	36	-	-	W24x19	-	-	-	130	10	80
68502700	G 3/4 EK	58	30	36	-	-	G 3/4 EK	-	-	-	147	10	80

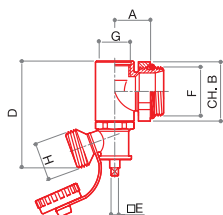
**SA 483**



Nickel plated terminal for manifolds, with swivel nut and built-in brass water drain tap:

- connection for air vent valve.

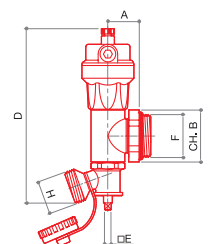
CODE	SIZE	A	B	C	D	E	F	G	H	L			
68503409	G 1" x G 3/8	24	37	-	72	5	G 1"	G 3/8	G 3/4	-	252	10	80
68503424	G 1" x G 1/2	24	37	-	72	5	G 1"	G 1/2	G 3/4	-	242	10	80



**SA 483/A**

Nickel plated terminal for manifolds, with swivel nut, built-in brass water drain tap and air vent valve.

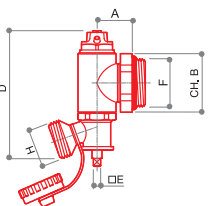
CODE	SIZE	A	B	C	D	E	F	G	H	L			
68503423	G 1"	24	37	-	135	5	G 1"	-	G 3/4	-	417	8	64

**SA 483/B**

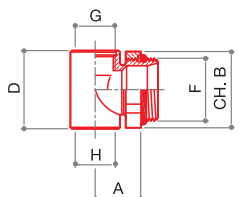

Nickel-plated terminal with locknut, water drain tap and built-in air vent valve.

CODE	SIZE	A	B	C	D	E	F	G	H	L			
68503426	G 1"	24	37	-	90	5	G 1"	-	G 3/4	-	266	8	64

**TC 488**

Terminal for manifolds with locknut:

- G 3/8 female or G 1/2 female connection for air vent valve
- G 1/2 female connection for water drain valve.

CODE	SIZE	A	B	C	D	E	F	G	H	L			
68503420	G 1/2 x G 1/2	24	37	-	41	-	G 1"	G 1/2	G 1/2	-	130	20	160
68503422	G 1/2 x G 3/8	24	37	-	41	-	G 1"	G 3/8	G 1/2	-	140	20	160

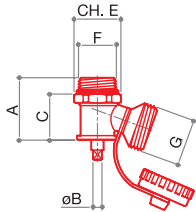

SA 492

Nickel-plated water drain valve with plug, lanyard and rotating drain.

CODE	SIZE	A	B	C	D	E	F	G	H	L			
68559815	G 1/2	34	5	25,5	-	24	G 1/2	G 3/4	-	-	112	30	240

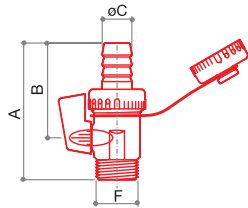

SA 494

Nickel plated ball valve for water drain, with lever, rubber holder and plug.

CODE	SIZE	A	B	C	D	E	F	G	H	L			
68559799	G 1/2	68	47	15	-	-	G 1/2	-	-	-	107	15	120



CB 1205

Insulation for 12-way manifolds CD series and CX.

CODE	SIZE			
72000064	CD G 1"	156	-	6
72000066	CX G 1"	149	-	6
72000065	CD G 1 1/4"	180	-	6

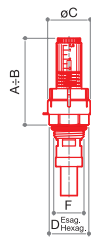

TM 4012

Regulator/flow meter 0,5÷5 l/min.

CODE	SIZE	A	B	C	D	E	F	G	H	L			
69000010	G 1/2	57	61	30	24	-	G 1/2	-	-	-	60	25	200

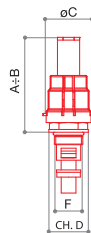



TM 4014

Regulator/flow meter 0,5÷5 l/min.

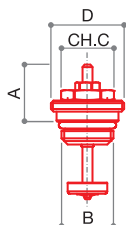
CODE	SIZE	A	B	C	D	E	F	G	H	L			
69000018	G 1/2	68,5	74	32,5	24	-	G 1/2	-	-	-	36	20	160



**560**

Thermostatic adjustment screw for manifolds CD series.

CODE	SIZE	CLOSING POINT	STROKE	A	B	C	D	E	F	G	H	L			
9446870	G 1/2	11,8	2,7	2,7	23	G 1/2	19	-	-	-	-		66	50	400

**555**

Screw for CP series sanitary manifolds with shut-off valves.

CODE	SIZE	CP SERIES MANIFOLDS			
9446820	G 3/8	for use with CP G 3/4 manifolds	38	50	400
9446822	G 3/8	for use with CP G 1" manifolds	40	50	400



**516**

Full sealing assembly for thermostatic and thermoelectric screw stem.

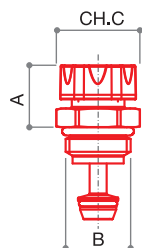
CODE	SIZE			
67980200	-	6	-	-

**563**

Lockshield screw fit for double micrometric balancing for manifold CD series.

CODE	FINISH	SIZE	STROKE	A	B	C	D	E	F	G	H	L			
9446841	YELLOW	G 1/2	7,8	20	G 1/2	24	-	-	-	-	-	-	66	50	400
9446843	NICKEL PLATED	G 1/2	7,8	20	G 1/2	24	-	-	-	-	-	-	66	50	400

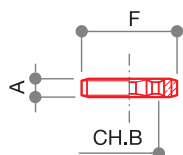
**501**

Adjustment collar for lockshield for manifolds CD series.

CODE	SIZE	A	B	C	D	E	F	G	H	L			
3346656	-	5	8	-	-	-	G 1/4	-	-	-	1	-	-



567

Fitting with seat for thermostatic screw art. 560, adjustment lockshield screw art. 563 and regulator/flow meter art. TM 4012, for manifold CD series.

CODE	SIZE	FINISH	A	B	C	D	E	F						
68552678	CD G 1" G 1/2 x (W24x19)	YELLOW	26	10	9,3	24	G 1/2	W24x19	TR 91	TP 95	TP 97	43	50	400
68552679	CD G 1 1/4" G 1/2 x (W24x19)	YELLOW	36	10	19,3	24	G 1/2	W24x19	TR 91	TP 95	TP 97	49	50	400
68552675	CD G 1" G 1/2 x G 3/4 EK	YELLOW	26	10,5	9,3	27	G 1/2	G 3/4 EK	TR 91/A	TP 98	TP 99	54	50	400
68552677	CD G 1 1/4" G 1/2 x G 3/4 EK	YELLOW	36	10,5	19,3	27	G 1/2	G 3/4 EK	TR 91/A	TP 98	TP 99	60	50	400
68552678N	CD G 1" G 1/2 x (W24x19)	NICKEL PLATED	26	10	9,3	24	G 1/2	W24x19	TR 91	TP 95	TP 97	43	50	400
68552679N	CD G 1 1/4" G 1/2 x (W24x19)	NICKEL PLATED	36	10	19,3	24	G 1/2	W24x19	TR 91	TP 95	TP 97	49	50	400
68552675N	CD G 1" G 1/2 x G 3/4 EK	NICKEL PLATED	26	10,5	9,3	27	G 1/2	G 3/4 EK	TR 91/A	TP 98	TP 99	53	50	400
68552677N	CD G 1 1/4" G 1/2 x G 3/4 EK	NICKEL PLATED	36	10,5	19,3	27	G 1/2	G 3/4 EK	TR 91/A	TP 98	TP 99	60	50	400



TM 4005

Flow meter 1÷4 l/min.

CODE	SIZE	A	B	C	D	E	F	G	H	L						
69000012	(W24x19) x (W24x19)	72	-	-	-	-	W24x19	W24x19	-	-	TR 91	TP 95	TP 97	126	25	200
69000015	G 3/4 EK x G 3/4 EK	64	-	-	-	-	G 3/4 EK	G 3/4 EK	-	-	TR 91/A	TP 98	TP 99	138	25	200

FLOW METER FLOW RATE CHART

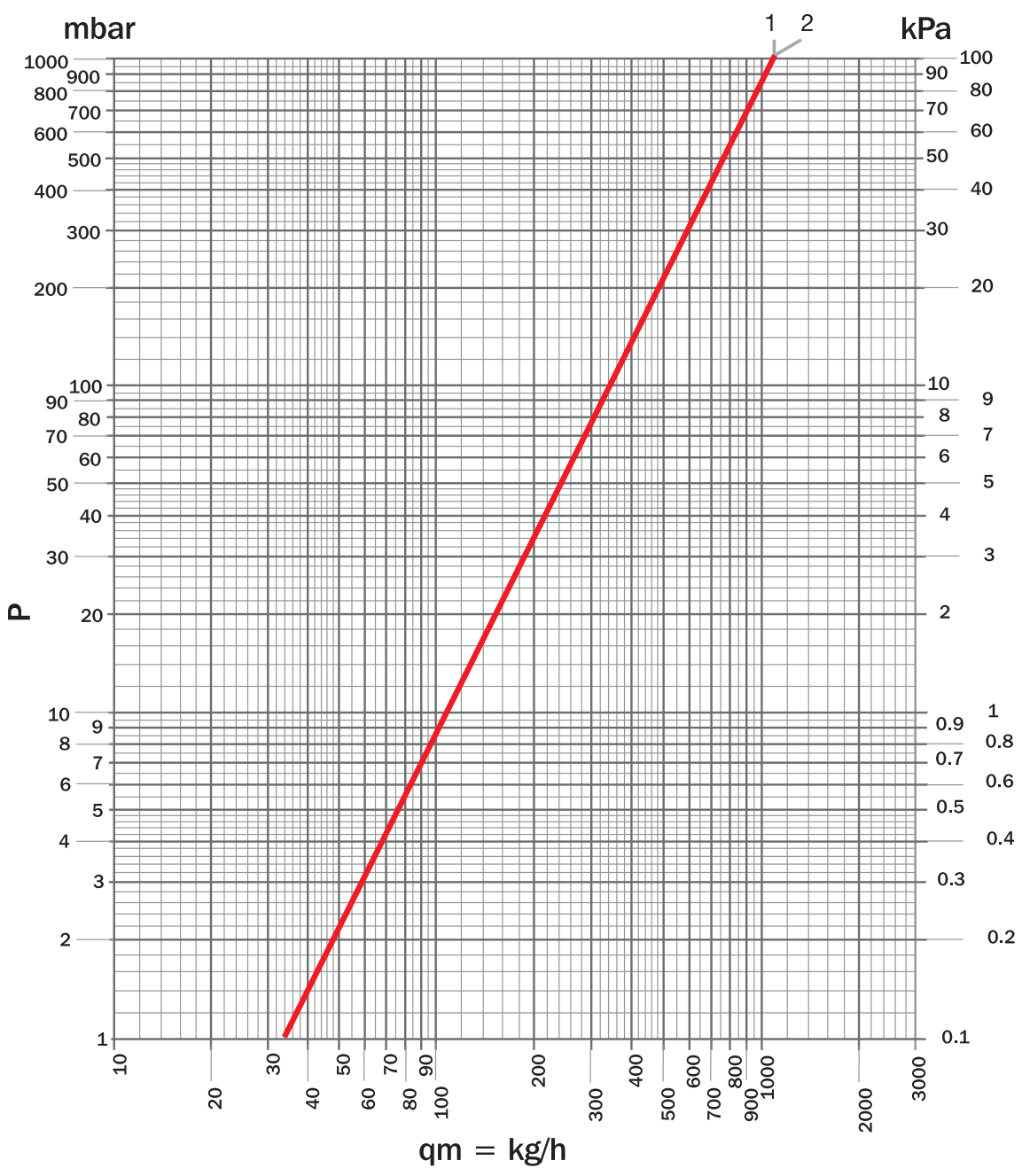

ITEM	SIZE	Kvs	POS
TM 4005	W24x19	1,15	1
TM 4005	G 3/4 EK		2

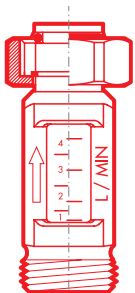

ADJUSTABLE BRACKET



The bracket has an adjustable wheelbase of 200 - 210 - 220 - 230 - 240 - 250 - 260 mm as needed.

The universal bracket is suitable for all Luxor manifolds with the exception of the 1/4"G1 CD series.

TECHNICAL DATA



Screw material

Fe



Bracket material

DD11



Upright material

PA6

INSTRUCTIONS FOR USE OF ADJUSTABLE BRACKETS SC 497

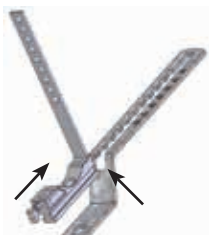

1. Insert the jumpers on the bracket by sliding them into the "H". profile.



5. The jumper is composed of a flexible clamp that can wrap any shape of the product to be fixed with this bracket.



2. Align the central hole with the desired centre distance (for example in the image 200mm), adjustment from 200mm to 260mm.



6. The clamp can be locked in 2 ways. The first involves inserting the fixed pin of the jumper into one of the holes of the clamp. This allows the product to be positioned without the use of tools. In some installations it may be sufficient because it is not necessary to securely anchor the manifold.



3. Disconnect the locking pin from the jumper and insert it into the appropriate seat.





7. The clamp can be locked in 2 ways. The second involves the use of a self-tapping screw which, positioned in the appropriate hole of the clamp, can tighten and securely lock the manifold to the bracket.

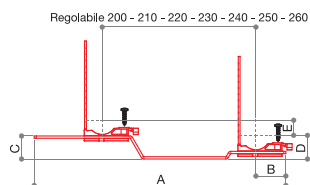

4. Repeat the operation with the other jumper for the unadjustable fixed position.



**SC 497**

Adjustable and universal metal/polyamide bracket for fixing the manifolds to metal or wall boxes.

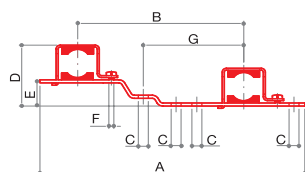
CODE	SIZE	A	B	C	D	E	F	G	H	L			
68559538	-	327.5	39	30	30.5	20	-	-	-	-	140	-	100





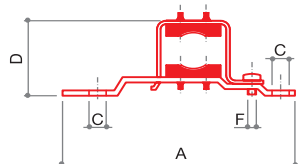

**SC 496**

Metal bracket for manifolds CD series and CX.

CODE	SIZE	A	B	C	D	E	F	G	H	L			
68559528	CD G 3/4 x 200	319	200	12	79	34	6 MA	119	-	-	270	-	100
68559535	CD G 1" x 200	319	200	12	79	30	6 MA	119	-	-	260	-	100
68559537	CX G 1" x 200	319	200	12	79	30	6 MA	119	-	-	265	-	100
68559734	CD G 1" x 250	366	250	12	89	-	6 MA	-	-	-	294	-	50
68559543	CD G 1"1/4 x 200	319	200	12	90	30	6 MA	114	-	-	290	-	80





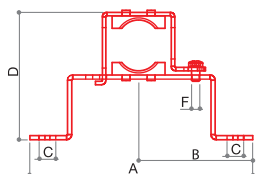

**SC 496/A**

Simple metal bracket for manifolds.

CODE				A	B	C	D	E	F			
68559429	3/4	1"	3/4	162,5	-	12	56,5	-	6 MA	140	-	100
68559436	1"	-	-	162,5	-	12	56,5	-	6 MA	134	-	100
68559437	-	-	1"	162,5	-	12	56,5	-	6 MA	138	-	100
68559442	1"1/4	-	-	162,5	-	12	56,5	-	6 MA	148	-	100

**SC 496/B**

High simple metal bracket for manifolds.

CODE				A	B	C	D	E	F			
68559428	3/4	1"	3/4	160	82	12	92	-	6 MA	136	-	70
68559435	1"	-	-	160	82	12	92	-	6 MA	136	-	70
68559433	-	-	1"	160	82	12	92	-	6 MA	140	-	70
68559443	1"1/4	-	-	160	87	12	103	-	6 MA	149	-	70

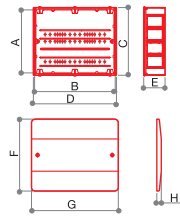

CF 477

Modular universal plastic cabinet with bottom, complete with bearings to fix modular simple, coplanar manifolds and distribution manifolds.

CODE	SIZE	A	B	C	D	E	F	G	H	L			
68560432	272 x 332 x 86	260	320	272	332	86	290	350	18	-	1000	1	20
68560440	272 x 412 x 86	260	400	272	412	86	290	430	18	-	1250	1	20
68560450	272 x 512 x 86	260	500	272	512	86	290	530	18	-	1500	1	20
68560460	272 x 612 x 86	260	600	272	612	86	290	630	18	-	1750	1	20



AC 477

Replacement accessories for fixing the manifolds inside the cabinet CF 477.

CODE	SIZE			
68560001	-	60	1	-

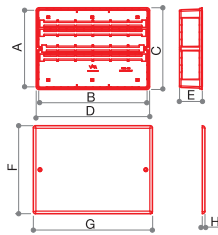

CF 479

Replacement accessories for fixing the manifolds inside the cabinet CF 479.

CODE	SIZE	A	B	C	D	E	F	G	H	L			
68560332	290 x 330 x 88	280	320	290	330	88	320	360	10	-	930	1	5
68560342	310 x 430 x 88	300	420	310	430	88	340	460	10	-	1175	1	5
68560352	330 x 530 x 88	320	520	330	530	88	360	560	10	-	1425	1	5
68560362	330 x 625 x 88	320	615	330	625	88	360	660	10	-	1715	1	5



AC 479

Replacement accessories for fixing the manifolds inside the cabinet CF 479.

CODE	SIZE			
68560005	-	70	1	-

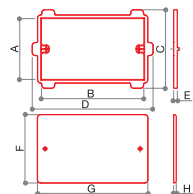

CT 474



Plastic frame and cover.

CODE	SIZE	A	B	C	D	E	F	G	H	L			
68560040	240 x 400	230	390	305	465	14	265	425	10	-	501	-	50
68560050	240 x 500	230	490	305	565	14	265	525	10	-	622	-	35
68560060	240 x 600	230	590	305	665	14	265	625	10	-	752	-	35

**CT 488**

Frame with door white enameled RAL 9016. Replacement for CF 485, CF486, CF 487 and CF 492.



ARTICLE DISCONTINUED.

CODE	SIZE			
68561005	500 x 450	3	-	1
68561007	700 x 450	4	-	1
68561008	850 x 450	5	-	1
68561010	1000 x 450	6	-	1
68561012	1200 x 450	7	-	1

**CT 489**



Frame and door white steel RAL 9016. Replacement for CF 489, CF 490 and CF 491.

ARTICLE DISCONTINUED.

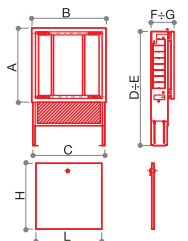
CODE	SIZE			
68561105	500 x 560	4	-	1
68561107	700 x 560	5	-	1
68561108	850 x 560	6	-	1
68561110	1000 x 560	7	-	1
68561112	1200 x 560	8	-	1
68561113	1300 x 560	9	-	1



**CF 485**

Zinc-plated steel wall cabinet for heating and sanitary applications, with adjustable frame and bearings, RAL 9016 white door and frame, for manifolds CD series.

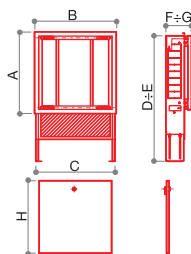
CODE	SIZE	A	B	C	D	E	F	G	H	L			
68560705	500 x 620 x 110	530	562	500	620	750	110	150	450	490	8	-	1
68560707	700 x 620 x 110	530	762	700	620	750	110	150	450	690	11	-	1
68560708	850 x 620 x 110	530	912	850	620	750	110	150	450	840	14	-	1
68560710	1000 x 620 x 110	530	1062	1000	620	750	110	150	450	990	17	-	1
68560712	1200 x 620 x 110	530	1262	1200	620	750	110	150	450	1190	20	-	1

**CF 490**

Zinc-plated steel wall cabinet for heating and sanitary applications, with adjustable frame and bearings, RAL 9016 white door and frame, for manifolds CD series.

CODE	SIZE	A	B	C	D	E	F	G	H	L			
68561405	500 x 720 x 90	630	560	500	720	860	90	130	560	490	9	-	1
68561407	700 x 720 x 90	630	760	700	720	860	90	130	560	690	12	-	1
68561408	850 x 720 x 90	630	910	850	720	860	90	130	560	840	15	-	1
68561410	1000 x 720 x 90	630	1060	1000	720	860	90	130	560	990	18	-	1
68561412	1200 x 720 x 90	630	1260	1200	720	860	90	130	560	1190	21	-	1
68561413	1300 x 720 x 90	630	1360	1300	720	860	90	130	560	1290	22,5	-	1

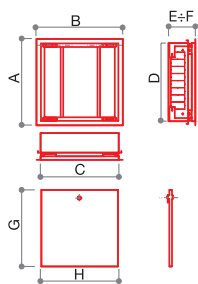

CF 491

Zinc-plated steel wall cabinet for heating and sanitary applications, with adjustable frame, RAL 9016 white door and frame, for manifolds CD series.

CODE	SIZE	A	B	C	D	E	F	G	H	L			
68561505	500 x 600 x 90	630	560	500	600	90	130	560	490	-	8	-	1
68561507	700 x 600 x 90	630	760	700	600	90	130	560	690	-	11	-	1
68561508	850 x 600 x 90	630	910	850	600	90	130	560	840	-	13	-	1
68561510	1000 x 600 x 90	630	1060	1000	600	90	130	560	990	-	15	-	1
68561512	1200 x 600 x 90	630	1260	1200	600	90	130	560	1190	-	18	-	1

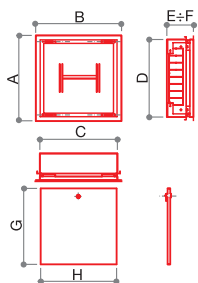

CF 492

Zinc-plated steel wall cabinet for heating and sanitary applications, with adjustable frame, RAL 9016 white door and frame, for manifolds CD series.

CODE	SIZE	A	B	C	D	E	F	G	H	L			
68561605	500 x 500 x 80	530	562	500	500	80	120	450	490	-	7	-	1
68561607	700 x 500 x 80	530	762	700	500	80	120	450	690	-	9	-	1
68561608	850 x 500 x 80	530	912	850	500	80	120	450	840	-	10,5	-	1



AC 490

Accessories kit: rails, bolts for cabinets CF 485 and CF 492.

CODE	SIZE			
68560002	-	434	1	-



AC 489

Accessories kit: rails, bolts for cabinets CF 490 and CF 491.

CODE	SIZE			
68560003	-	506	1	-

G 1"

HOW TO CHOOSE THE RIGHT CABINET

G 1" MANIFOLD

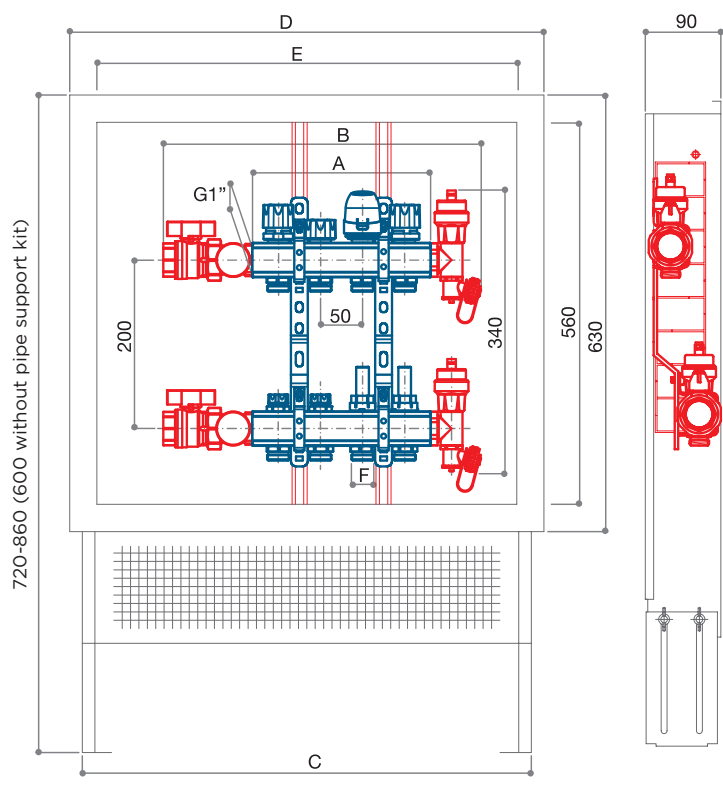

							CABINETS	
OUTLETS	A	B	C	D	E	F	ITEM	CODE
2	112	276	500	560	490	W24x19 - G 3/4 EK	CF 490	68561405
3	162	326						
4	212	376						
5	262	426	700	760	690		CF 490	68561407
6	312	476						
7	362	526						
8	412	576	850	910	840		CF 490	68561408
9	462	626						
10	512	676						
11	562	726	1000	1060	990		CF 490	68561410
12	612	776						
13	662	826						

G 1" MANIFOLD WITH DRAIN

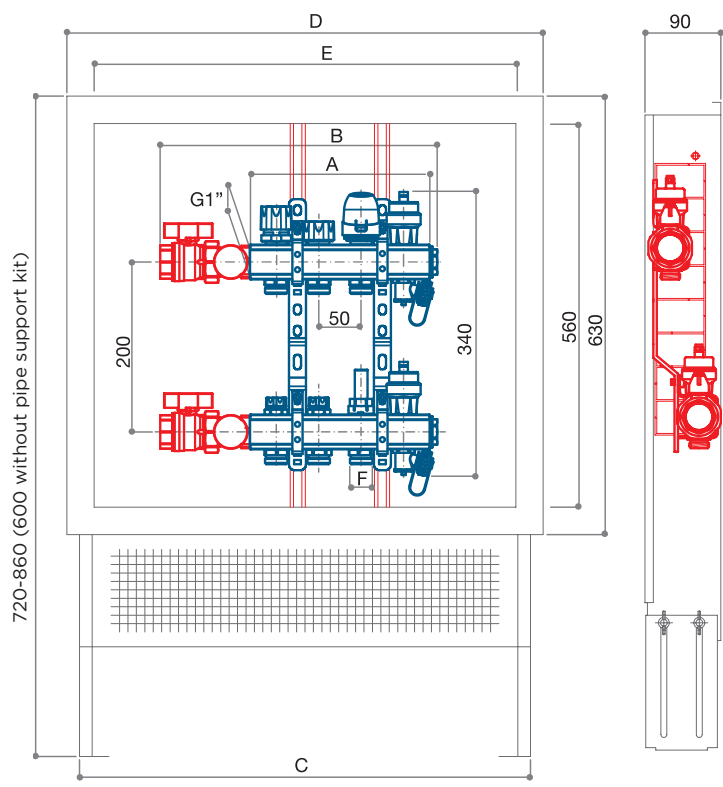

							CABINETS	
OUTLETS	A	B	C	D	E	F	ITEM	CODE
2	162	276	500	560	490	W24x19 - G 3/4 EK	CF 490	68561405
3	212	326						
4	262	376						
5	312	426	700	760	690		CF 490	68561407
6	362	476						
7	412	526						
8	462	576	850	910	840		CF 490	68561408
9	512	626						
10	562	676						
11	612	726	662	776				
12	662	776						

G 1 1/4

HOW TO CHOOSE THE RIGHT CABINET

G 1 1/4 MANIFOLD

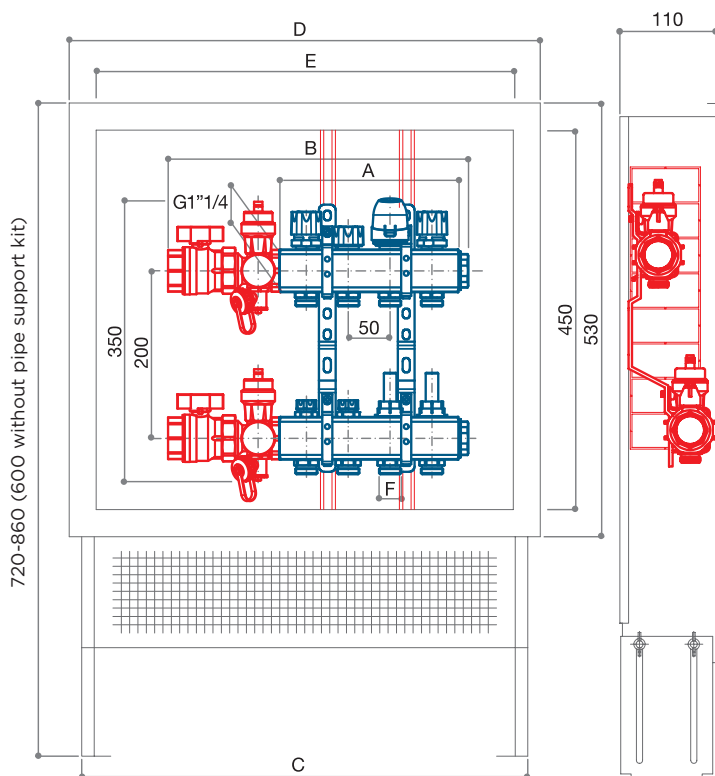

							CABINETS	
OUTLETS	A	B	C	D	E	F	ITEM	CODE
2	114	260	500	565	490	W24x19 - G 3/4 EK	CF 485	68560705
3	164	310						
4	214	360						
5	264	410						
6	314	460						
7	364	510	700	765	690		CF 485	68560707
8	414	560						
9	464	610						
10	514	660	850	915	840		CF 485	68560708
11	564	710						
12	614	760						
13	664	810	1000	1065	990		CF 485	68560710

G 1 1/4 MANIFOLD WITH DRAIN

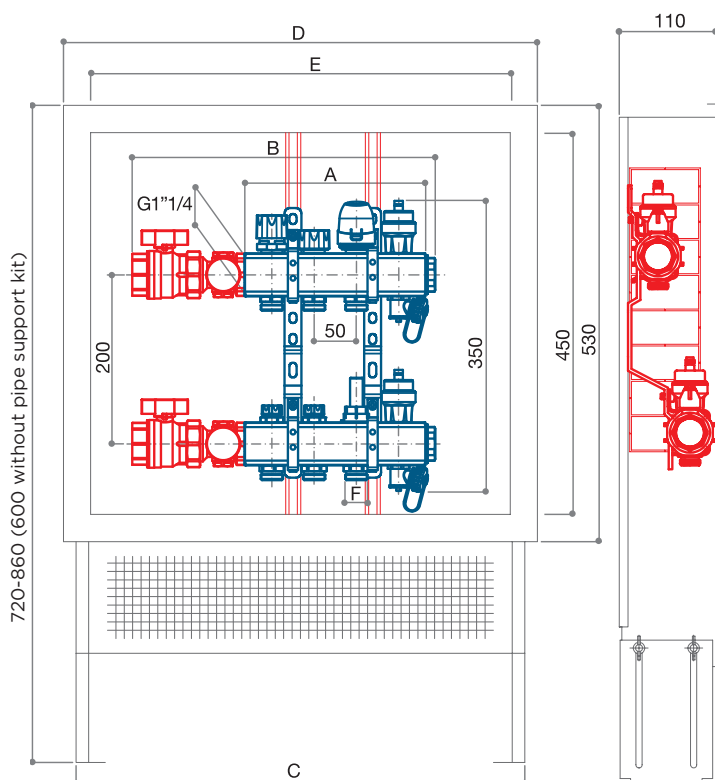

							CABINETS	
OUTLETS	A	B	C	D	E	F	ITEM	CODE
2	164	310	500	565	490	W24x19 - G 3/4 EK	CF 485	68560705
3	214	360						
4	264	410						
5	314	460						
6	364	510						
7	414	560	700	765	690		CF 485	68560707
8	464	610						
9	514	660						
10	564	710	850	915	840		CF 485	68560708
11	614	760						
12	664	810						
			1000	1065	990		CF 485	68560710

G 1"

HOW TO CHOOSE THE RIGHT CABINET

G 1" MANIFOLD

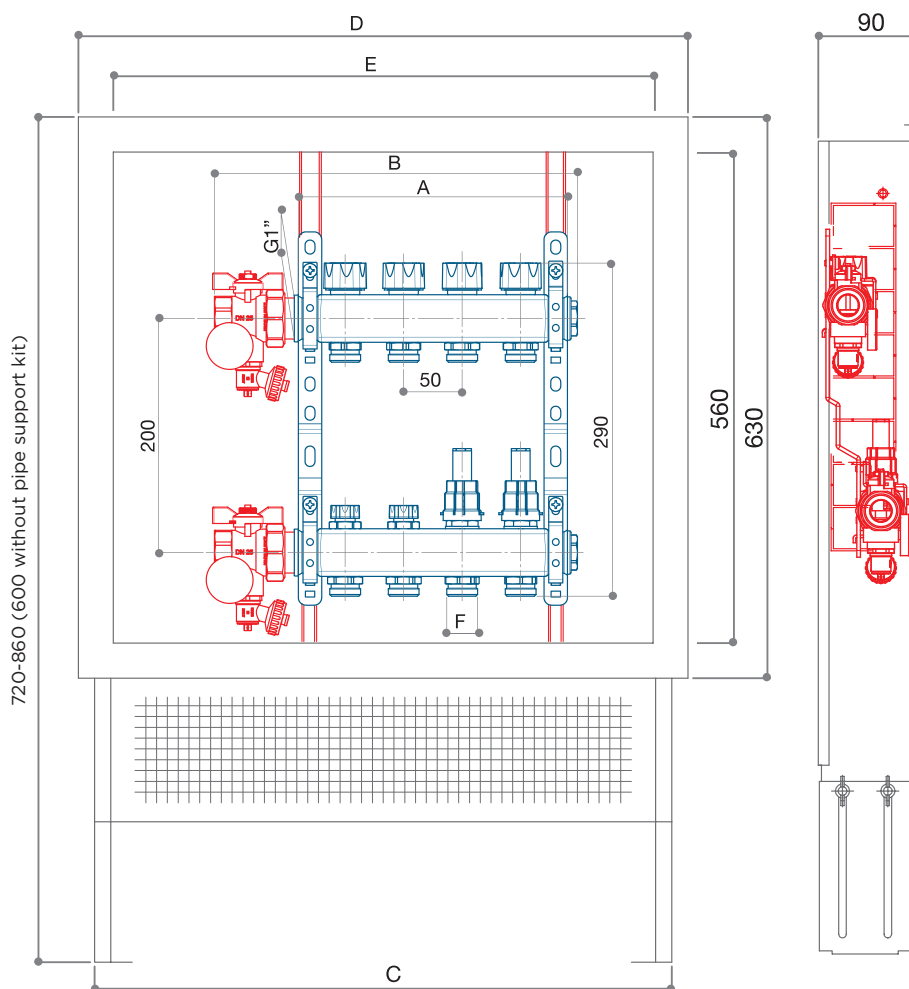

							CABINETS	
OUTLETS	A	B	C	D	E	F	ITEM	CODE
2	130	210	500	560	490	W24x19 - G 3/4 EK	CF 490	68561405
3	180	260						
4	230	310						
5	280	360						
6	330	410	700	760	690		CF 490	68561407
7	380	460						
8	430	510						
9	480	560						
10	530	610	850	910	840		CF 490	68561408
11	580	660						
12	630	710						
13	680	760						
14	730	810	1000	1060	990	CF 490	68561410	
15	780	860						
16	830	910						



LUXOR®

3 / VALVES

BALL VALVES



CONSTRUCTIVE FEATURES

All of Luxor ball valves are manufactured in CW 617 N brass and compatible with Luxor manifolds and components. Given the wide range of dimensions and models, they suit a variety of application needs.

Luxor ball valves' pivot pin is installed from the inside. This system, known as "explosion-proof", prevents the pivot pin and its sealing system from escaping, while making external tampering impossible as well. Ball valves feature two elastomeric O-ring seals, chosen for their high resistance to ageing. As prescribed by Italian decree on drinking water supply D.M. 174/2004, the valves are machined after the nickel-plating phase, thus ensuring hygiene and an appreciable aesthetic result.

TECHNICAL DATA



Max temperature

90 °C



Max pressure

10 bar



Materials

CW617N

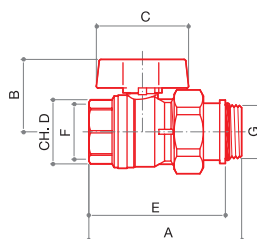

VC 471

Nickel plated full-flow ball valve, blue or red handle, with fitting article CR 498 with o-ring for connection to manifold.

CODE	SIZE	A	B	C	D	E	F	G	H	L			
68559772B	G 1/2	69	40	48	25	61	G 1/2	G 1/2	-	-	210	10	80
68559772R	G 1/2	69	40	48	25	61	G 1/2	G 1/2	-	-	210	10	80
68559805B	G 3/4	90	39	60	33	80	G 3/4	G 3/4	-	-	370	10	80
68559805R	G 3/4	90	39	60	33	80	G 3/4	G 3/4	-	-	370	10	80
68559807B	G 1"	89	43	60	41	78	G 1"	G 1"	-	-	467	5	40
68559807R	G 1"	89	43	60	41	78	G 1"	G 1"	-	-	467	5	40
68559825B	G1"1/4	123	53	72	50	109	G 1"1/4	G 1"1/4	-	-	907	3	24
68559825R	G1"1/4	123	53	72	50	109	G 1"1/4	G 1"1/4	-	-	907	3	24

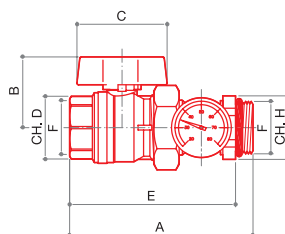

VC 471/A

Ball valve with blue or red handle and thermometer (range 0 °C÷80 °C) for connection to manifolds CD series.

CODE	SIZE	A	B	C	D	E	F	G	H	L			
68559800B	G 1"	115	43	60	41	104	G 1"	-	37	-	562	4	32
68559800R	G 1"	115	43	60	41	104	G 1"	-	37	-	562	4	32

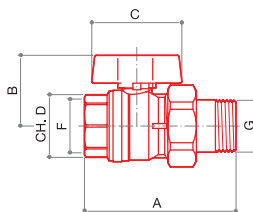

VC 472

Nickel plated full-flow ball valve, with blue or red handle and fitting.

CODE	SIZE	A	B	C	D	E	F	G	H	L			
68559774B	G 1/2	73	40	48	25	-	G 1/2	G 1/2	-	-	205	10	80
68559774R	G 1/2	73	40	48	25	-	G 1/2	G 1/2	-	-	205	10	80
68559806B	G 3/4	91	39	60	33	-	G 3/4	G 3/4	-	-	365	10	80
68559806R	G 3/4	91	39	60	33	-	G 3/4	G 3/4	-	-	365	10	80
68559808B	G 1"	95	43	60	41	-	G 1"	G 1"	-	-	487	5	40
68559808R	G 1"	95	43	60	41	-	G 1"	G 1"	-	-	487	5	40
68559818B	G1"1/4	126	53	72	50	-	G 1"1/4	G 1"1/4	-	-	904	3	24
68559818R	G1"1/4	126	53	72	50	-	G 1"1/4	G 1"1/4	-	-	904	3	24

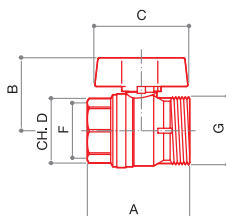

VC 475

Nickel plated full-flow ball valve, without pipe union, with blue or red handle.

CODE	SIZE	A	B	C	D	E	F	G	H	L			
68559770B	G 1/2F x G 3/4M	45	40	48	25	-	G 1/2	G 1/2	-	-	138	10	80
68559770R	G 1/2F x G 3/4M	45	40	48	25	-	G 1/2	G 1/2	-	-	138	10	80
68559811B	G 3/4F x G 1"M	59	39	60	33	-	G 3/4	G 1"	-	-	252	10	80
68559811R	G 3/4F x G 1"M	59	39	60	33	-	G 3/4	G 1"	-	-	252	10	80
68559809B	G 1"F x G1"1/4M	61	43	60	41	-	G 1"	G 1"1/4	-	-	311	5	40
68559809R	G 1"F x G1"1/4M	61	43	60	41	-	G 1"	G 1"1/4	-	-	311	5	40
68559804B	G1"1/4F x G1"1/2M	87	53	72	50	-	G 1"1/4	G 1"1/2	-	-	666	3	24
68559804R	G1"1/4F x G1"1/2M	87	53	72	50	-	G 1"1/4	G 1"1/2	-	-	666	3	24

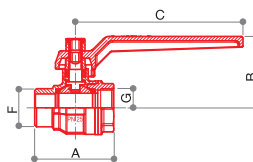

VC 476

Nickel plated full-flow ball valve, without pipe union, with blue or red lever.

CODE	SIZE	A	B	C	D	E	F	G	H	L			
68559829B	G 1"1/2	91	75	150	-	-	G 1"1/2	G 1"1/2	-	-	1400	2	16
68559829R	G 1"1/2	91	75	150	-	-	G 1"1/2	G 1"1/2	-	-	1400	2	16

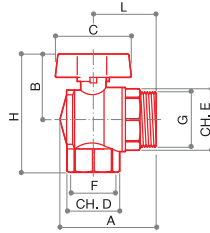

VS 470

Nickel plated full-flow ball valve, without pipe union, with blue or red handle.
*ARTICLE DISCONTINUED.

CODE	SIZE	A	B	C	D	E	F	G	H	L	⚖️	📦	📦
68559810B	G 1" F x G 1" 1/4 M	72	50	57	39	43	G 1"	G 1" 1/4	90	47	582	5	40
68559810R	G 1" F x G 1" 1/4 M	72	50	57	39	43	G 1"	G 1" 1/4	90	47	582	5	40
68559776B*	G 1" 1/4 F x G 1" 1/2 M	-	-	-	-	-	G 1" 1/4	G 1" 1/2	-	-	810	3	24
68559776R*	G 1" 1/4 F x G 1" 1/2 M	-	-	-	-	-	G 1" 1/4	G 1" 1/2	-	-	810	3	24

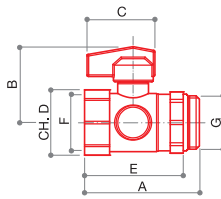

VCG 480

Nickel-plated ball valve with swivel male and blue or red handle.

CODE	SIZE	A	B	C	D	E	F	G	H	L	⚖️	📦	📦
68559719B	G 1"	71	42	42	38	61	G 1"	G 1"	-	-	368	5	40
68559719R	G 1"	71	42	42	38	61	G 1"	G 1"	-	-	368	5	40

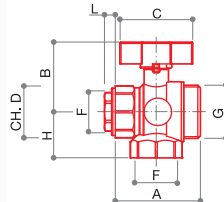

VCS 476

Straight and angle nickel plated ball valve with blue or red handle.

CODE	SIZE	A	B	C	D	E	F	G	H	L	⚖️	📦	📦
68559711B	G 1" F x G 1" 1/4 M	66,5	55	62	38	-	G 1"	G 1" 1/4	36	9	510	5	40
68559711R	G 1" F x G 1" 1/4 M	66,5	55	62	38	-	G 1"	G 1" 1/4	36	9	510	5	40

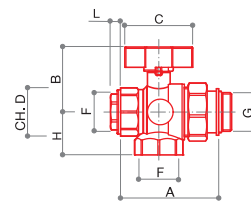

VCS 478

Straight and angle nickel plated ball valve with red/blue handle and fitting CR 498 with o-ring for connection to manifold.

CODE	SIZE	A	B	C	D	E	F	G	H	L	⚖️	📦	📦
68559715B	G 1"	82	55	62	38	-	G 1"	G 1"	36	9	658	5	40
68559715R	G 1"	82	55	62	38	-	G 1"	G 1"	36	9	658	5	40

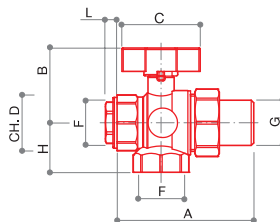

VCS 477

Straight and angle nickel-plated ball valve with blue or red handle and fitting.

CODE	SIZE	A	B	C	D	E	F	G	H	L			
68559713B	G 1"	99	55	62	38	-	G 1"	G 1"	36	9	684	5	40
68559713R	G 1"	99	55	62	38	-	G 1"	G 1"	36	9	684	5	40

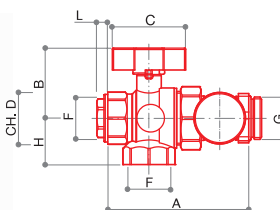

VCS 479

Straight and angle nickel-plated ball valve with blue or red handle and thermometer (range 0 °C ÷ 80 °C) for manifolds CD series.

CODE	SIZE	A	B	C	D	E	F	G	H	L			
68559717B	G 1"	110	55	62	38	-	G 1"	G 1"	36	9	766	4	32
68559717R	G 1"	110	55	62	38	-	G 1"	G 1"	36	9	766	4	32

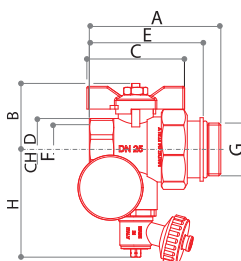

VC 481

Multipurpose water inlet ball valve with manual air vent, blue or red butterfly handle and CR 498 fitting with O-ring for manifold connection, complete with 0°C ÷80°C thermometer.

CODE	SIZE	A	B	C	D	E	F	G	H	L			
68559722B	G 1"	81	41	60	38	70	G 1"	G 1"	70	-	645	4	32
68559722R	G 1"	81	41	60	38	70	G 1"	G 1"	70	-	645	4	32

BYPASS VALVES FOR HEATING SYSTEMS



TECHNICAL DATA



Brass parts materials
CW614N



Gaskets OR
EPDM



Spring
AISI 302

FUNCTION

Bypass valves are essential in all distribution systems with 2-way zone valves or heating bodies with adjustment valves, which enable, under certain circumstances, to bypass a circuit.

The recirculation guaranteed by the valve prevents the pump from working under improper conditions, thus avoiding imbalances among circuits operating in parallel and annoying noise caused by the increased speed of the fluid flowing through the adjustment devices.

Bypass valves VB 755 was specifically designed to be easily used with Luxor manifolds and their accessories.

This bypass valve can be installed on a variety of devices, the only requirement is the presence of two opposed G 1/2 female threads.

INSTALLATION INSTRUCTIONS

Insert the bypass valve between the inlet and the outlet pipe, downstream of the circulation pump.

As shown in the above picture, the valve consists of two parts:

- valve seat with inlet fitting;
 - adjusting element with scale from 0,2 to 0,7 bar.
- Please note: the fitting must be exclusively installed on the fluid inlet side.

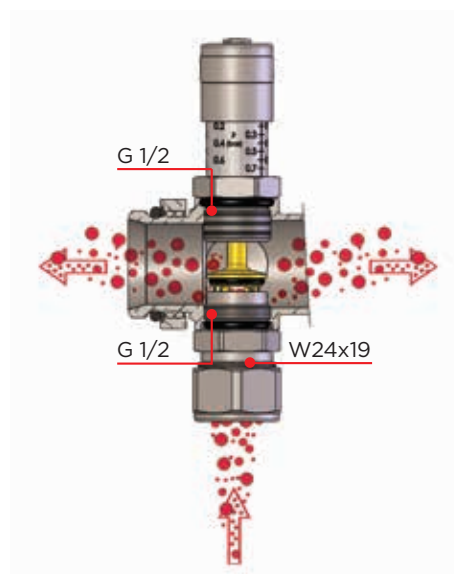
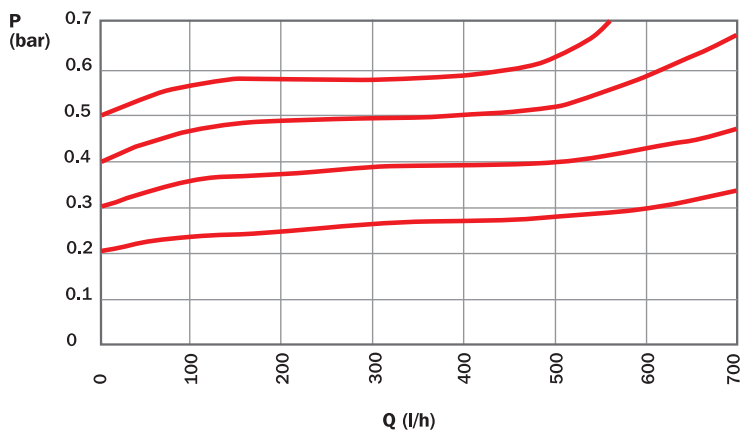

ADJUSTMENT

Turn the knob until the edge is aligned with the required value on the graduated scale marked on the valve body.

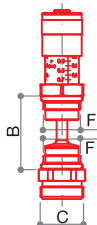



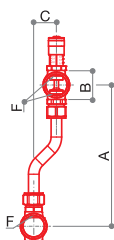

VB 755
Bypass valve.

CODE	SIZE	A	B	C	D	E	F	G	H	L			
68512109	CD G 1"	-	41	W24x19	-	-	G 1/2	-	-	-	158	10	80
68512110	CD G 1"1/4	-	51	W24x19	-	-	G 1/2	-	-	-	182	10	80



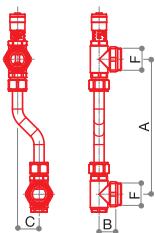

VB 750
Bypass valve.

CODE	SIZE	A	B	C	D	E	F	G	H	L			
68512101	CD G 1" x 200 mm	200	41	32	-	-	G 1/2	-	-	-	330	8	64
68512115	CD G 1" x 250 mm	250	41	32	-	-	G 1/2	-	-	-	350	8	64
68512102	CD G 1"1/4 x 200 mm	200	51	32	-	-	G 1/2	-	-	-	330	8	64



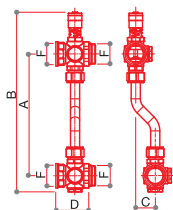

VB 751
Bypass valve with terminals for manifolds.

CODE	SIZE	A	B	C	D	E	F	G	H	L			
68512103	G 1" x 200 mm	200	25	32	-	-	G 1"	-	-	-	400	5	40
68512116	G 1" x 250 mm	250	25	32	-	-	G 1"	-	-	-	420	4	32



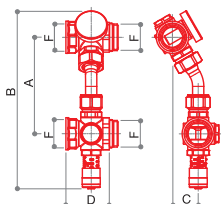

VB 752
Bypass valve with pipe unions for ball valve with or without thermometer.

CODE	SIZE	A	B	C	D	E	F	G	H	L			
68512105	G 1" x 200 mm	200	295	32	54	-	G 1"	-	-	-	766	3	24
68512117	G 1" x 250 mm	250	295	32	54	-	G 1"	-	-	-	820	3	24



VB 753
Bypass valve kit for high temperature GM 1192.

CODE	SIZE	A	B	C	D	E	F	G	H	L			
68512108	G1"	120	223	32	54	-	G 1"	-	-	-	784	3	24

AIR VENT VALVES



TECHNICAL DATA

Max temperature	Max temperature (solar system version)	Max pressure	Max discharge pressure
110 °C	200 °C	10 bar	6 bar

INSTALLATION AND USE

VS air vent valves boast an excellent air flow rate and are essential to release air bubbles from heating systems. Whilst providing a high air flow capacity, their compact size enables to install VS air vent valves on gas wall-hung boilers as well as on manifolds and wherever air needs to be released from piping.

The valve allows for full air evacuation either automatically or manually, depending on the model.

The valve shall be installed in an upright position at all points in the heating system where air is likely to collect.

In order for automatic valves to operate, the brass plug shall be loosened.

When combined with check valve VS 605, automatic air vent valves may be removed without draining the system.

Automatic air vent valves are also available in a version for solar systems with a maximum operating temperature of 200°C.

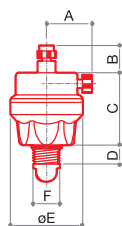

VS 602

G 3/8 automatic and manual float air vent valve reduced type. Nickel plated.

CODE	SIZE	A	B	C	D	E	F	G	H	L			
67790310N	G 3/8	25	15	40	10	40	G 3/8	-	-	-	148	15	120

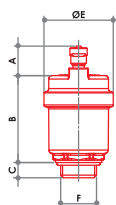

VS 604/A

Automatic air vent valve.



CODE	SIZE	FINISH	A	B	C	D	E	F	G	H	L			
67790300	G 3/8	YELLOW	17	50	9	-	40	G 3/8	-	-	-	138	10	100
67790700	G 1/2	YELLOW	17	50	9	-	40	G 1/2	-	-	-	138	10	100
67790300N	G 3/8	NICKEL PLATED	17	50	9	-	40	G 3/8	-	-	-	138	10	100
67790700N	G 1/2	NICKEL PLATED	17	50	9	-	40	G 1/2	-	-	-	138	10	100

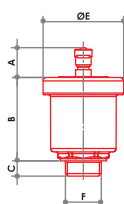

VS 601

Automatic air vent valve medium type.



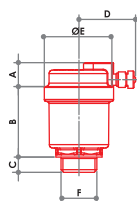

CODE	SIZE	A	B	C	D	E	F	G	H	L			
67790117	G 3/8	17	50	9	-	46	G 3/8	-	-	-	154	10	100
67790121	G 1/2	17	50	9	-	46	G 1/2	-	-	-	154	10	100
67790127	G 3/4	17	50	9	-	46	G 3/4	-	-	-	154	10	100

**VS 603**

Automatic air vent valve with side discharge.

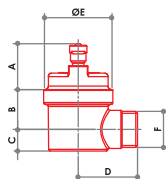

Testing
100%

CODE	SIZE	A	B	C	D	E	F	G	H	L			
67790417	G 3/8	14	41	9	34	40	G 3/8	-	-	-	160	10	100
67790421	G 1/2	14	41	9	34	40	G 1/2	-	-	-	160	10	100

**VS 606**

Automatic air vent valve with side discharge.

Testing
100%

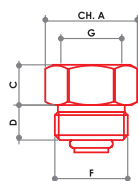

CODE	SIZE	A	B	C	D	E	F	G	H	L			
67790517	G 3/8	27	23	13	35	40	G 3/8	-	-	-	162	10	100
67790521	G 1/2	27	23	13	35	40	G 1/2	-	-	-	162	10	100

**VS 605**

Check valve for automatic air vent valve.

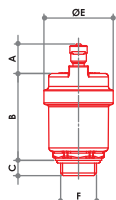
CODE	SIZE	FINISH	A	B	C	D	E	F	G	H	L			
67791200	G 3/8F x G 3/8M	YELLOW	19	-	12	9	-	G 3/8	G 3/8	-	-	18	100	800
67791400	G 3/8F x G 1/2M	YELLOW	23	-	12	9	-	G 1/2	G 3/8	-	-	40	100	800
67791600	G 1/2F x G 1/2M	YELLOW	23	-	12	9	-	G 1/2	G 1/2	-	-	30	100	800
67791200N	G 3/8F x G 3/8M	NICKEL PLATED	19	-	12	9	-	G 3/8	G 3/8	-	-	18	100	800
67791400N	G 3/8F x G 1/2M	NICKEL PLATED	23	-	12	9	-	G 1/2	G 3/8	-	-	40	100	800
67791600N	G 1/2F x G 1/2M	NICKEL PLATED	23	-	12	9	-	G 1/2	G 1/2	-	-	30	100	800

**VS 604/S**Automatic air vent valve.
200°C - 10 bar.Testing
100%

CODE	SIZE	A	B	C	D	E	F	G	H	L			
67791017	G 3/8	17	50	9	-	40	G 3/8	-	-	-	138	10	100
67791021	G 1/2	17	50	9	-	40	G 1/2	-	-	-	138	10	100

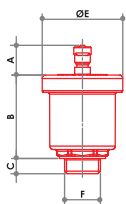

VS 601/S

Automatic air vent valve medium type.
200°C - 10 bar.



CODE	SIZE	A	B	C	D	E	F	G	H	L			
67790817	G 3/8	17	50	9	-	46	G 3/8	-	-	-	154	10	100
67790821	G 1/2	17	50	9	-	46	G 1/2	-	-	-	154	10	100
67790827	G 3/4	17	50	9	-	46	G 3/4	-	-	-	154	10	100

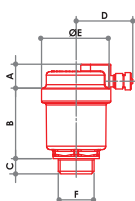

VS 603/S

Automatic air vent valve with side discharge. 200°C - 10 bar.



CODE	SIZE	A	B	C	D	E	F	G	H	L			
67790917	G 3/8	14	41	9	34	40	G 3/8	-	-	-	160	10	100
67790921	G 1/2	14	41	9	34	40	G 1/2	-	-	-	160	10	100

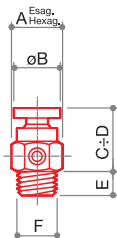

VS 610

Manual air vent valve with brass hand-wheel.



CODE	SIZE	A	B	C	D	E	F	G	H	L			
67793000	G 1/8	13	14	20	23	7	G 1/8	-	-	-	20	100	800
67793500	G 1/4	13	14	17	19	7	G 1/4	-	-	-	20	100	800
67794000	G 3/8	16	14	17	19	7	G 3/8	-	-	-	30	100	800

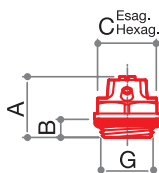

VS 620

Manual air vent valve with white ABS upper part, o-ring on thread, rotating drain.



CODE	SIZE	A	B	C	D	E	F	G	H	L			
67795417	G 3/8	21	7	19	-	-	-	G 3/8	-	-	21	100	800
67795421	G 1/2	21	8	22	-	-	-	G 1/2	-	-	24	100	800



CH 620





Butterfly key for valve VS 620.

CODE	SIZE			
67795400	-	1	200	-

RELIEF VALVES



TECHNICAL DATA

			
Temperature range	Operating pressure	Opening overpressure	Blowdown
5 ÷ 110 °C	according to setting	20%	20%

CONSTRUCTIVE FEATURES

Relief valves are used to control pressure in heat generators in heating systems and hot water build-ups in sanitary installations and water facilities. Once the set pressure is reached, the valve opens and discharges in the atmosphere, thus preventing the pressure in the system to rise to levels which may be dangerous for its components.

OPERATING PRINCIPLE

The obturator is opposed by a C72 steel calibrated spring which is preloaded according to the set pressure chosen depending on the system's maximum allowable operating pressure. Once the set pressure is reached, the obturator rises and opens the outlet completely. If the pressure decreases, the valve closes within the set tolerance values.

The diameter of the outlet connection shall be equal to the valve size or higher, so as to facilitate the needed discharge of potential.

According to Italian standards, ordinary relief valves may be installed on generators with a potential of less than 35 kW.

INSTALLATION

Relief valves may be installed either vertically or horizontally, but not upside down, in order to prevent impurities from depositing and causing malfunctioning.

Relief valves must be installed on the top of the generator, on the nearest inlet pipe or within the maximum distance prescribed by applicable standards. No shut-off valve shall be installed between the relief valve and the generator.

The valve must be sized properly before the installation in accordance with existing regulations governing specific applications. Relief valves shall not be employed for purposes other than their intended use.



Relief valves must be installed by qualified technical personnel in accordance with current regulations.

The relief valve must be installed respecting the direction of flow shown by the arrow on the valve body.



VS 910



Ordinary relief valve with diaphragm
1/2 x 1/2 F/F.

CODE	SIZE	bar			
67795001	1/2 x 1/2 F/F	1,5	110	10	100
67795002		1,8	110	10	100
67795003		2	110	10	100
67795004		2,5	110	10	100
67795005		3	110	10	100
67795006		3,5	110	10	100
67795007		4	110	10	100
67795008		5	110	10	100
67795009		6	110	10	100
67795010		7	110	10	100
67795011		8	110	10	100
67795012		10	110	10	100





VS 911

Ordinary relief valve with diaphragm
1/2 x 1/2 M/F.

CODE	SIZE	bar			
67795014	1/2 x 1/2 M/F	1,5	120	10	100
67795015		1,8	120	10	100
67795016		2	120	10	100
67795017		2,5	120	10	100
67795018		3	120	10	100
67795019		3,5	120	10	100
67795020		4	120	10	100
67795021		5	120	10	100
67795022		6	120	10	100
67795023		7	120	10	100
67795024		8	120	10	100
67795025		10	120	10	100



**VS 920**

Ordinary relief valve with diaphragm
3/4 x 3/4 F/F.

CODE	SIZE	bar			
67795027	3/4 x 3/4 F/F	1,5	170	10	100
67795028		1,8	170	10	100
67795029		2	170	10	100
67795030		2,5	170	10	100
67795031		3	170	10	100
67795032		3,5	170	10	100
67795033		4	170	10	100
67795034		6	170	10	100
67795035		7	170	10	100
67795036		8	170	10	100
67795037	10	170	10	100	



**VS 930**

Ordinary relief valve with diaphragm 1"
x 1" F/F.

CODE	SIZE	bar			
67795039	1" x 1" F/F	1,5	250	10	100
67795040		1,8	250	10	100
67795041		2,5	250	10	100
67795042		3	250	10	100
67795043		4	250	10	100
67795044		6	250	10	100



**VS 912**

Ordinary relief valve with diaphragm
1/2 x 1/2 F/F with 1/4 socket for
manometer.

CODE	SIZE	bar			
67795046	1/2 x 1/2 F/F	1,5	130	10	100
67795047		1,8	130	10	100
67795048		2	130	10	100
67795049		2,5	130	10	100
67795050		3	130	10	100
67795051		3,5	130	10	100
67795052		4	130	10	100
67795053		6	130	10	100

**VS 913**

Ordinary relief valve with diaphragm
1/2 x 1/2 M/F with 1/4 socket for
manometer.

CODE	SIZE	bar			
67795055	1/2 x 1/2 M/F	1,5	135	10	100
67795056		1,8	135	10	100
67795057		2	135	10	100
67795058		2,5	135	10	100
67795059		3	135	10	100
67795060		3,5	135	10	100
67795061		4	135	10	100
67795062		6	135	10	100

MIXING VALVE



APPLICATIONS

The 3-way valve VM 652 can be used as a diverter or mixing valve in heating and air conditioning systems using water or water-glycol **max** 30%.

The valve VM 650 is specifically intended for use in radiant panel heating systems. It works similarly to a 2-way thermostatic valve with an open bypass on the return from the radiant panel. The way B-AB is always open.

3-way valves series VM are usually open and can be used in combination with the thermostatic valve art. TT 2351 as fixed point mixers in heating systems, or electrically controlled with heads series TE and actuators series SM.

SPECIAL FEATURES

VM valves offer:

- high Kvs values;
- a precise modulation thanks to the stroke and shape of the obturator, which can immediately open both the direct passage and the bypass, thus securing flow modulation all along the stroke. (VM 652)
- very low leakage even when used in systems with high differential pressure.

TECHNICAL DATA

Maximum allowed leakage with max ΔP

- 0.05% of the Kvs for the straight passage
- 0.1% of the Kvs for the bypass

Kvs through the lower bypass around 30% of the straight passage

Way A-AB flow Kvs 3.5 - maximum allowed ΔP 0.8 bar

Way B-AB flow Kvs 2.6 - maximum allowed ΔP 1.8 bar



Max temperature

120 °C



Max pressure

16 bar



Press-forged parts materials

CW617N
UNI EN
12165:2016



Obturator materials

CW614N
UNI EN
12164:2016



Stainless steel parts materials

AISI 303



Gaskets OR

EPDM

FUNCTION

The mixing valves VM650-652 can be installed either vertically or horizontally position. Observe the connections on the body and in the picture.

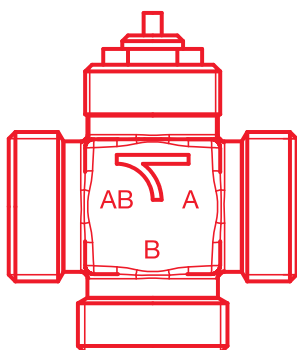

VM 650		VM 652			
MIXING VALVE		MIXING VALVE		DIVERTER VALVE	
A	inlet 1	A	inlet 1	AB	inlet
B	inlet 2	B	inlet 2	A	outlet 1
AB	mixed (bypass way B-AB)	AB	mixed	B	outlet 2
Kvs (m ³ /h)		Kvs (m ³ /h)		Kvs (m ³ /h)	
A-AB = 3,5		A-AB = 3,5		AB-A = 3,9	
B-AB = 2,6		B-AB = 2,6		AB-B = 2,8	
ΔP MAX (bar)		ΔP MAX (bar)		ΔP MAX (bar)	
A-AB = 0,8		A-AB = 0,8		AB-A = 3,5	
B-AB = -		B-AB = 1,8		AB-B = 1	

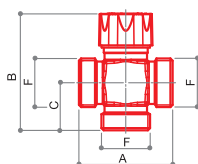

VM 650

Thermostatic mixing valve with lateral mixing and bypass.

CODE	SIZE	A	B	C	D	E	F	G	H	L	⚙️	📦	📦
68753411	G 1"	64	80	35	-	-	G 1"	-	-	-	346	1	30

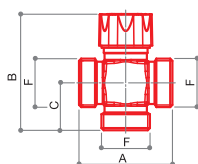

VM 652

Thermostatic mixing valve with lateral mixing.

CODE	SIZE	A	B	C	D	E	F	G	H	L	⚙️	📦	📦
68753413	G 1"	64	80	35	-	-	G 1"	-	-	-	260	1	30



DIVERTING ZONE VALVES



CONSTRUCTIVE FEATURES

VZ diverting zone valves are solid brass valves, specifically designed to be easily and quickly automated through electric actuators; they are compact and can be installed even in 80 mm deep cabinets.

TECHNICAL DATA

 Temperature range (valve) -20 °C ÷ +80 °C	 Temperature range (actuator) -20 °C ÷ +70 °C	 Working pressure see graphic drawing below
--	---	--

HYDRAULIC SCHEMES

VZ702
Three-way bypass diagram

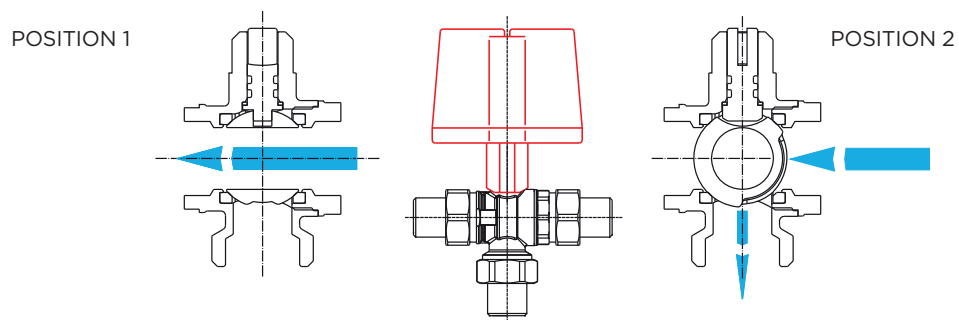

MAX WORKING PRESSURE / TEMPERATURE DIAGRAM

(test carried out with water)

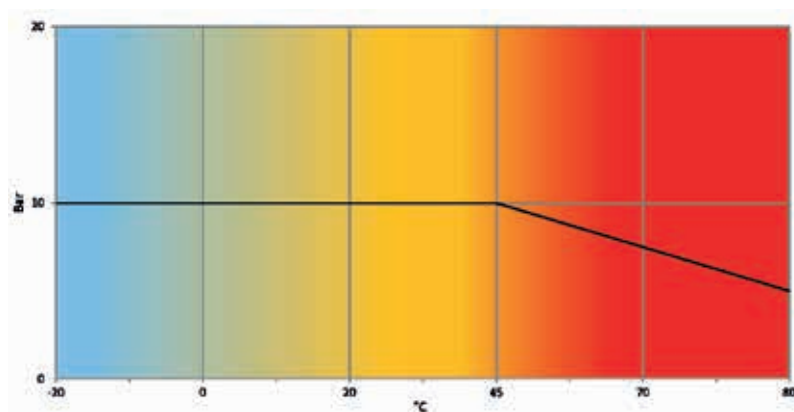

ACTUATOR FEATURES

Power supply voltage	230V 50-60Hz
Absorbed power	46 VA
Input signal	2 Points / SPST / On-Off / with internal relay
Assembly	Quick Mounting
Working time	12 Sec
Weight	0,3 Kg
Motor type	Bidirectional

Working angle	90°
Protection	IP54
Operating temperature	-20 / +70 °C
Connection	Wires Cable 5 Wires
Additional aux contact	250V 0.5A (AC1)
Kvs 3/4 2-way	41
Kvs 1" 2-way	70

ELECTRICAL CONNECTIONS

SM700

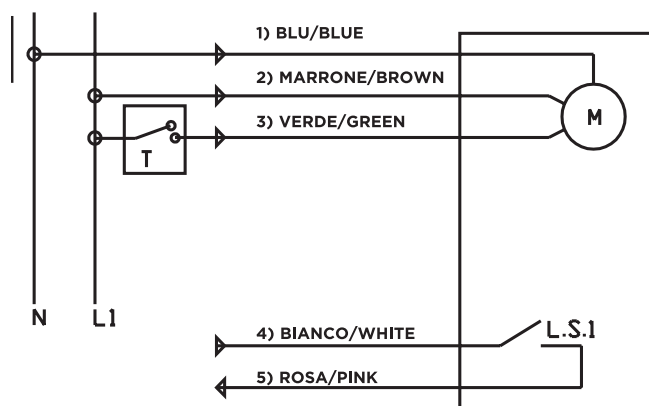

- 1 BLUE** - neutral 230V 50/60Hz
2 BROWN - live 230V 50/60Hz
3 GREEN - live to open / disconnected to close
4 WHITE - common aux. contact
5 PINK - n.o. aux. contact

- N** - neutral (sn)
L1 - live (sp)
T - thermostat (relay)
L.S.1 - aux. contact

WIRE COLOR	DIRECTION	FUNCTION	DESCRIPTION	CONNECTION
Blue	In	Power supply	Neutral (sn)	Connection to neutral
Brown	In	Power supply	Live (sp)	Connection to phase
Green	In	Thermostat (relay)	Open-closed (y1)	When phase connected valve opens; when not phase connected valve closes
White/Pink	Out	Auxiliary output	Clean contact	When valve is open, the two wires are shorted

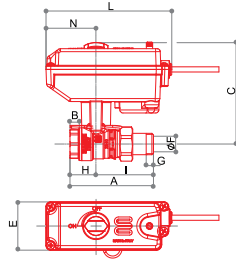

VZ 700

Zone valve F-M with compact electric actuator.

CODE	SIZE	A	B	C	E	F	G	H	I	L	N			
68812700	G 3/4	91	11	102	46.5	20	12	29	62	121	48	1250	1	-
68813400	G 1"	104.5	12.5	106	46.5	25	12	35	69.5	121	48	1430	1	-

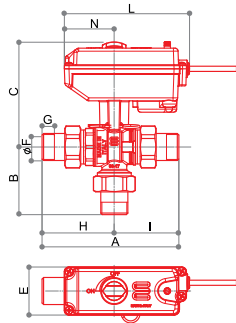

VZ 702

Zone valve M-M-M with compact electric actuator.

CODE	SIZE	A	B	C	D	E	F	H	I	L	N			
68822700	G 3/4	132.5	65.5	102	165.5	46.5	20	62.5	70	121	48	1480	1	-
68823400	G 1"	151	70	106	175	46.5	25	70	81	121	48	1950	1	-

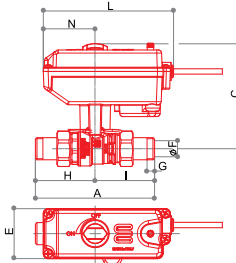

VZ 704

Zone valve M-M with compact electric actuator.

CODE	SIZE	A	B	C	E	F	G	H	I	L	N			
68842700	G 3/4	130	-	102	46.5	20	12	68	62	121	48	1155	1	-
68843400	G 1"	147	-	106	46.5	25	12	77.5	69.5	121	48	1414	1	-

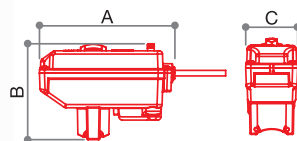

SM 700

Electric actuator for zone valves VZ 700, VZ 702 and VZ 704.

CODE	SIZE	A	B	C	D	E			
69011720	230 V - ON/OFF	121	86	46.5	-	-	480	1	-

DEMAX

MAGNETIC DIRT SEPARATOR FOR HEATING SYSTEM



Energy-saving issues as well as the rational use of resources are very current topics; therefore it is necessary to keep the heating circuit efficient by using a magnetic dirt separator filter placed on the return pipe to capture the impurities present in the heat carrier fluid and avoid any damage they could cause to the heating system.

This device must be installed on the heating circuit, and once positioned, it is necessary to fill the heating system up again, emptying the air in excess.

The main technical data are:

- It prevents the risk of obstruction of the heating circuit pipes and its components.
- Should the boiler be replaced, the dirt separator filter can be mounted on the new one.

TECHNICAL DATA



Max temperature
65 °C



Room temperature
+5°C ...+ 50°C



Water working pressure
1,0 ÷ 2,0 bar



Maximum water pressure
3,0 bar

Water content in the heating circuit: ~ 0,2 l

Magnet: Ø12x60 mm, 4500 gauss

Width: 101,5 mm

Height: 116,5 mm

Net weight: 175 g

Fittings supplied: G3/4

OPERATING SCHEME

The dirt separator filter can be installed in two different ways (horizontally or vertically) in order to be suitable to the majority of the domestic hydraulic circuits already existing as well as the new ones.

- 1) Heating system return circuit / dirt separator filter inlet
- 2) Dirt separator filter outlet / towards the boiler
- 3) Position of G 3/4 brass female end cap
- 4) Position of M12 grey plastic end cap for filter's emptying.

Installation with the filter placed horizontally

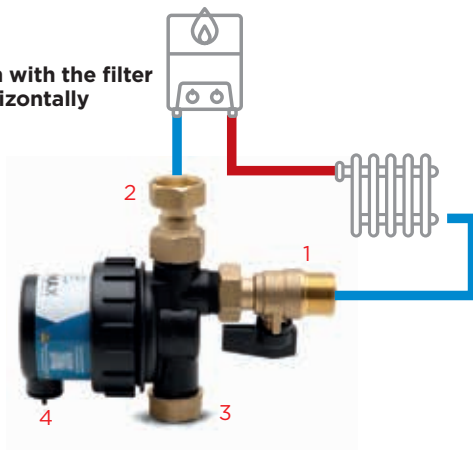

Installation with the filter placed vertically



VALVES

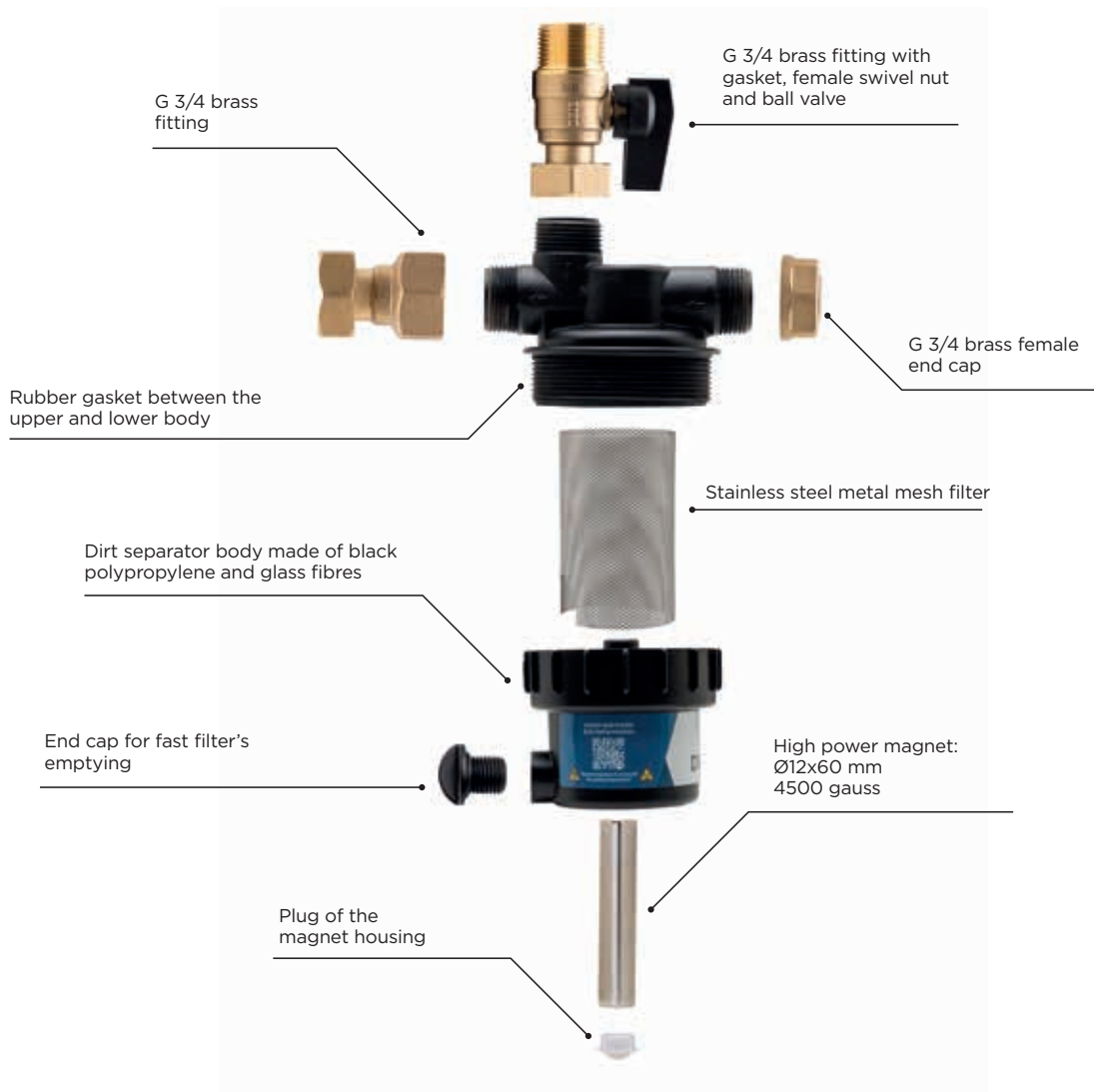

OPERATING PRINCIPLE

The water flow returning from the heating system passes through the inlet fitting of the dirt separator filter, then it flows through the internal area where there is the magnet and the stainless steel metal mesh and goes out through the outlet fitting of the dirt separator filter.

MAGNETIC DIRT SEPARATOR FOR HEATING SYSTEM

**DM 2018**

Magnetic dirt separator for heating system.

CODE	SIZE			
68550010	G 3/4	542	1	6



4 / PREASSEMBLED GROUPS

PUMPING AND MIXING GROUPS



GM 1197

Adjustable mixing group with fixed point regulating unit with integrated sensor. Suitable for circulators G 1" 1/2 centre distance 130 mm and bracketed manifolds G 1" centre distance 200 mm. Complete with safety thermostat with immersion probe.

CODE	SIZE			
72000310	G 1"	2334	1	8



GM 1195

Adjustable mixing group with fixed point regulating unit. Suitable for circulators G 1" 1/2 centre distance 130 mm and bracketed manifolds G 1" centre distance 200 mm.

CODE	SIZE			
72000300	G 1"	2184	1	8



GR 1194

Mixing group suitable for circulators G 1" 1/2 centre distance between 130 mm and 180 mm. Adjustable brackets between 200 mm and 250 mm for steel and brass manifolds. Differential bypass valve with adjustment between 0.2 and 0.7 bar. G 1" manifold connections for use with CP G 3/4 manifolds.

CODE	SIZE			
72000320	G 1"	2703	1	-

REGULATION SYSTEMS FOR RADIANT PANELS HEATING WITH PUMP GROUP GP 1190

20 kW



TECHNICAL DATA

Maximum working pressure 10 bar
Maximum differential pressure 1 bar
Maximum working temperature 120 °C

TECHNICAL DATA WITH GP 1190

Maximum working pressure 6 bar
Maximum differential pressure 1 bar
Maximum working temperature 70 °C
Temperature range on secondary circuit 20 °C ÷ 65 °C
Maximum thermal power 20kW with Δt 10 °C and temperature on the primary circuit ≥ 70 °C

CONSTRUCTIVE FEATURES

Press-forged parts consist of brass with limited lead content in compliance with the current regulations: CW617N UNI EN 12165:2016. All o-rings are produced in peroxide cured EPDM. Stainless steel components in AISI 316. All components are provided with soft o-rings and do not require any intermediate sealing element (PTFE, hemp, etc.). Side connections W24x19 or G 3/4 EK with 50 mm interaxis.

The pump group GP 1190 has a \varnothing 23 mm internal passage.

APPLICATIONS

The system for fixed point heating has the advantage of being particularly compact and to employ all series components of Luxor manifolds, which are already available on the market, with the only addition of two specific items:

- art. GP 1190;
- art. TT 3051.

This system enables to easily and economically obtain a mixed heating system in households where both high temperature heating bodies (60°C÷70°C) and low temperature radiant panels (20°C÷50°C) are installed.

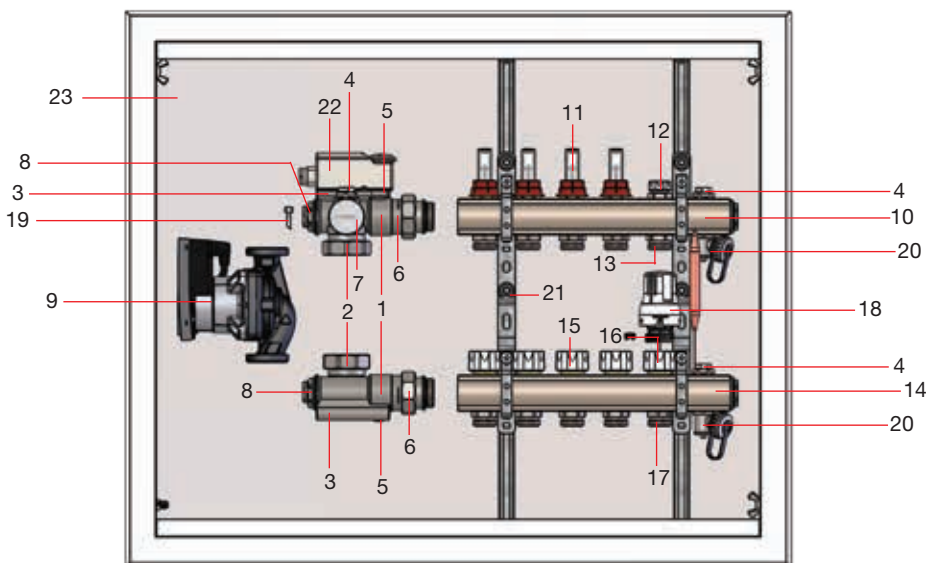

COMPONENTS

- | | |
|---|--|
| <p>1 Pump group</p> <p>2 Connections to circulation pump with swivel nut G 1"1/2</p> <p>3 Seat for regulation probe of the thermostatic head and arrangement for seat for the safety thermostat sensor.</p> <p>4 Manual air vent valve</p> <p>5 Ball valves for pump interception</p> <p>6 G 1" connections with soft seal</p> <p>7 Thermometer</p> <p>8 G 1/2 female connections for further devices</p> <p>9 Circulation pump with synchronous motor 25/60, interaxis 130mm, energy class A</p> <p>10 Delivery manifold for radiant panels</p> <p>11 Regulators and flow meters, from 0,5l/min to 5l/min. It is possible to open the glass for cleaning while the system is operating</p> | <p>12 Low temperature circuit check valve</p> <p>13 Connection for boiler return</p> <p>14 Radiant panels return manifold</p> <p>15 Valves for electrothermal regulation, with protection caps</p> <p>16 Thermostatic adjustment valve</p> <p>17 Connection to boiler flow</p> <p>18 Thermostatic head with remote sensor</p> <p>19 Spring to fix the remote sensor of the thermostatic head</p> <p>20 Water load/drain tap</p> <p>21 Brackets</p> <p>22 Contact bimetallic safety thermostat</p> <p>23 Cabinet with adjustable ends, RAL 9016 white frame and door.</p> |
|---|--|

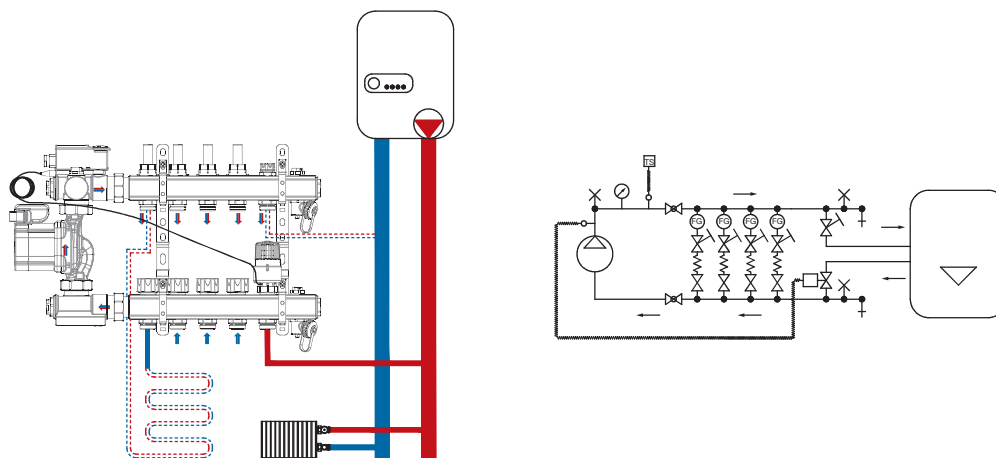

HYDRAULIC SCHEME LEGEND

	check valve		water load/drain tap		circulation pump
	ball valve		thermometer		user: radiant panels, radiators etc.
	non-return valve, the arrow indicates the direction of flow		manual air vent device		filter
	safety valve (bypass valve)		automatic air vent device		3-way valve
	check valve, regulation and balancing		flow meter		
	ball check valve regulation and balancing		immersion safety thermostat		
	injection valve with remote sensor		contact safety thermostat		

FUNCTION

Fixed point heating systems keep the water in the radiant panels at a constant pre-set temperature by mixing hot water coming from the boiler with the one circulating in the panels. A thermostatic valve with remote sensor measures the temperature and adds hot water to the circuit accordingly, so as to compensate the heat output of the radiant panels. It is advisable to install a security thermostat on the pump inlet valve in order to avoid damages caused by a sudden temperature rise. The intervention of the thermostat must block the functioning of the pump.

The system can be complemented with a bypass valve. In case of excessive differential pressure, the bypass valve releases the exceeding pressure, thus protecting the components and, if thermoelectric heads are employed to intercept the circuits, avoiding noise and wear on the circulation pump. This type of system can supply a max thermal power of 20 kW with a Δt of 10°C and a temperature of $\geq 70^\circ\text{C}$ on the primary side.

REGULATION SYSTEMS FOR RADIANT PANELS HEATING WITH PUMP GROUP GP 1190



GP 1190

G 1" valve with pump connection for mixed heating system, max thermometer temperature 80 °C.

CODE	SIZE			
72000030	G 1"	2107	1	8



Depth
90 mm

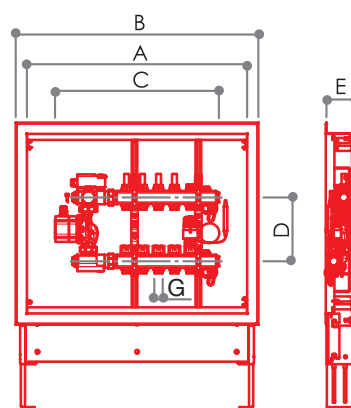

CCBP 4022

Fixed point distribution system for low temperature heating (W24x19).

ARTICLE	CODE	SIZE	N. PANEL CONNECTIONS	A	B	C	D	E	F	G	H	L		
CCBP4022/2	17402202N	G 1" x (W24x19)	2	500	560	420	200	90	-	W24x19	-	-	17,312	1
CCBP4022/3	17402203N		3	700	760	470			-		-	19,906	1	
CCBP4022/4	17402204N		4	700	760	520			-		-	20,500	1	
CCBP4022/5	17402205N		5	700	760	570			-		-	21,094	1	
CCBP4022/6	17402206N		6	700	760	620			-		-	21,688	1	
CCBP4022/7	17402207N		7	850	910	670			-		-	24,282	1	
CCBP4022/8	17402208N		8	850	910	720			-		-	24,876	1	
CCBP4022/9	17402209N		9	850	910	770			-		-	25,470	1	
CCBP4022/10	17402210N		10	1000	1060	820			-		-	28,064	1	
CCBP4022/11	17402211N		11	1000	1060	870			-		-	28,658	1	



Depth
90 mm

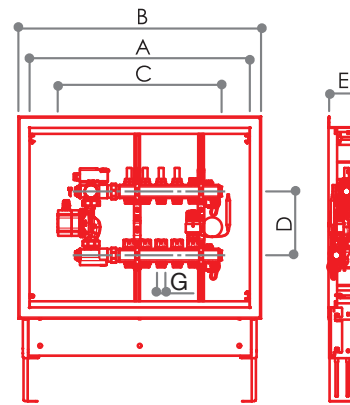

CCBP 4032

Fixed point distribution system for low temperature heating G 3/4 EK.

ARTICLE	CODE	SIZE	N. PANEL CONNECTIONS	A	B	C	D	E	F	G	H	L	kg	⇒
CCBP4032/2	17403202N	G 1" x G 3/4 EK	2	500	560	420	200	90	-	G 3/4 EK	-	-	17,312	1
CCBP4032/3	17403203N		3	700	760	470			-		-	19,906	1	
CCBP4032/4	17403204N		4	700	760	520			-		-	20,500	1	
CCBP4032/5	17403205N		5	700	760	570			-		-	21,094	1	
CCBP4032/6	17403206N		6	700	760	620			-		-	21,688	1	
CCBP4032/7	17403207N		7	850	910	670			-		-	24,282	1	
CCBP4032/8	17403208N		8	850	910	720			-		-	24,876	1	
CCBP4032/9	17403209N		9	850	910	770			-		-	25,470	1	
CCBP4032/10	17403210N		10	1000	1060	820			-		-	28,064	1	
CCBP4032/11	17403211N		11	1000	1060	870			-		-	28,658	1	

FLOW RATE CHART

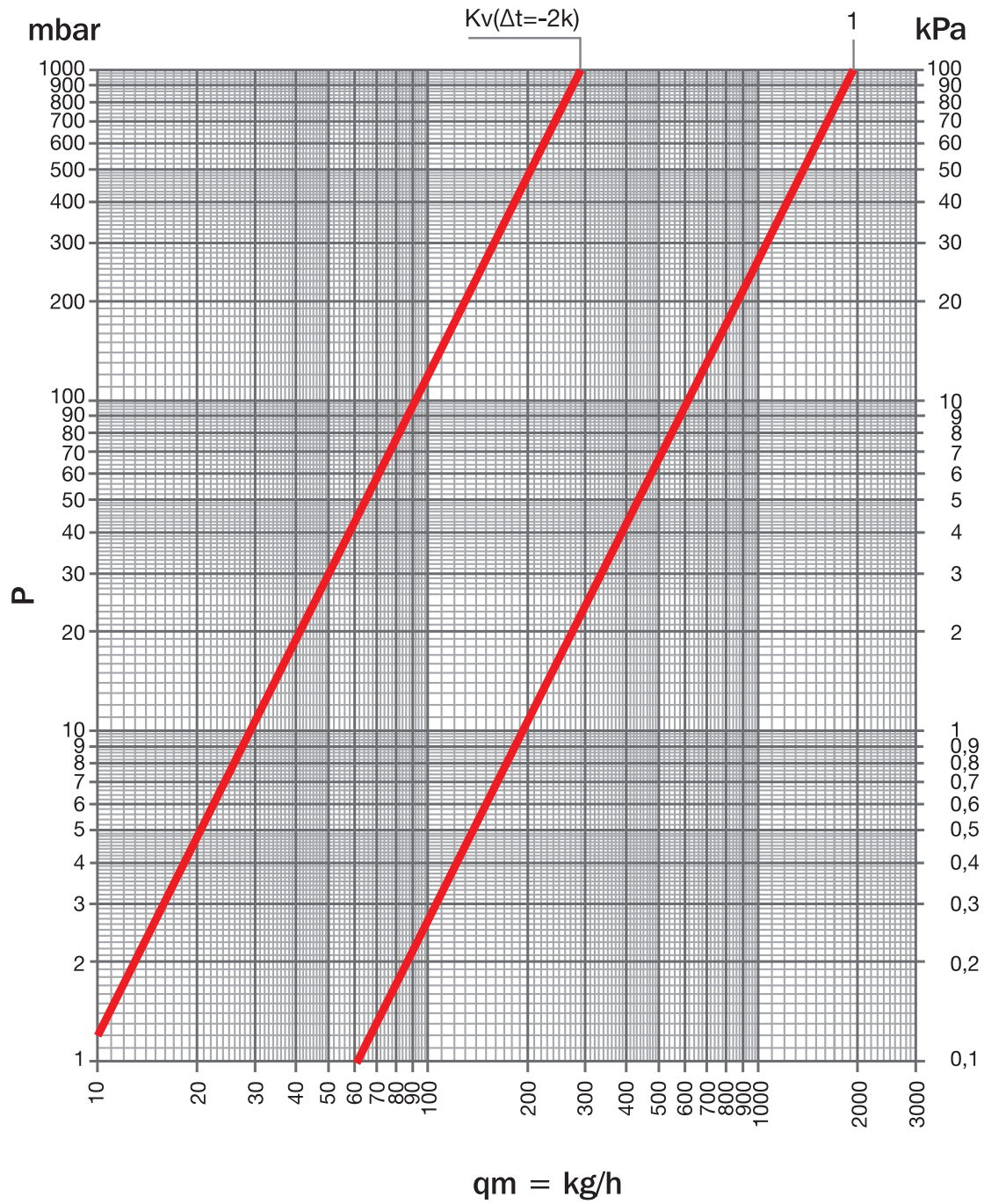

Kv	Kv Δt 2 °C	POS
1,92	00,29	1

REGULATION SYSTEM FOR RADIANT PANELS HEATING WITH PUMP GROUP GP 1190 AND KIT FOR HIGH TEMPERATURE KA 1191



14 kW

TECHNICAL DATA

Maximum working pressure 10 bar
 Maximum differential pressure 1 bar
 Maximum working temperature 80 °C

TECHNICAL DATA SISTEMA CON GP 1190 + KA 1191

Maximum working pressure 6 bar
 Maximum differential pressure 1 bar
 Maximum working temperature on primary side 80 °C
 Maximum working temperature on secondary side 70 °C
 Temperature range on secondary side 20 °C ÷ 65 °C
 Maximum thermal power 14 kW with Δt 10 °C and temperature on the primary side ≥ 70 °C

APPLICATIONS

When combined with pump group GP 1190, the kit for high temperature KA 1191 allows to install a hot water distribution for traditional radiator systems and a water distribution system for radiant panels in one single cabinet.

CONSTRUCTIVE FEATURES

Press-forged parts consist of brass with limited lead content in compliance with the current regulations: CW617N UNI EN 12165:2016. All o-rings are produced in peroxide cured EPDM. Stainless steel components in AISI 316.

All components are provided with soft o-rings and do not require any intermediate sealing element (PTFE, hemp, etc.). Side connections W24x19 or G 3/4 EK with 50 mm interaxis. The pump group GP 1190 has a \varnothing 23 mm internal passage.

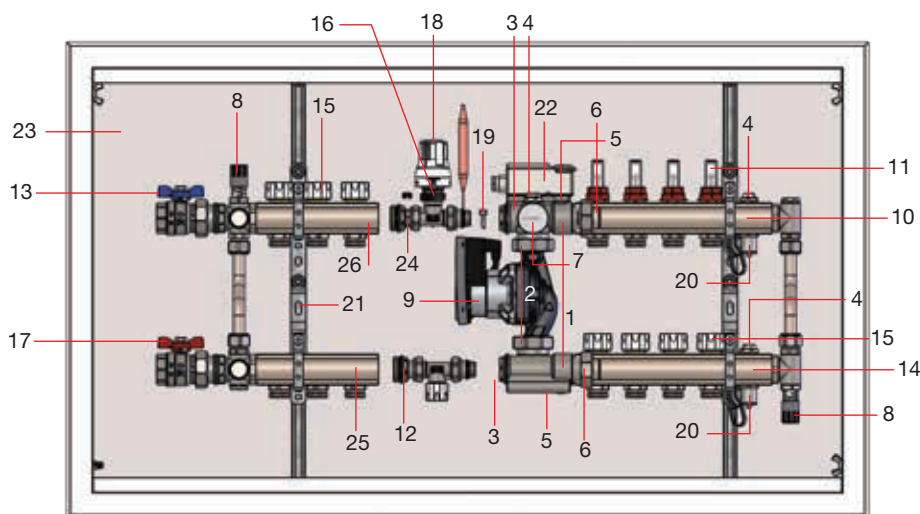

COMPONENTS

- | | |
|---|---|
| <ul style="list-style-type: none"> 1 Pump group 2 Connections to circulation pump with swivel nut G 1"1/2 3 Seat for regulation probe of the thermostatic head 4 Manual air vent valve 5 Ball valves for pump interception 6 G 1" connections with soft seal 7 Thermometer 8 Differential bypass valve 9 Circulation pump with synchronous motor 25/60 interaxis 130 mm, energy class A 10 Delivery manifold for radiant panels 11 Regulators and flow meters, from 0,5 l/min to 5 l/min. It is possible to open the glass for cleaning while the system is operating 12 Low temperature circuit check valve 13 Boiler return ball valve | <ul style="list-style-type: none"> 14 Radiant panels return manifold 15 Valves for electrothermal regulation, with protection caps 16 Thermostatic adjustment valve 17 Delivery ball valve from boiler 18 Thermostatic head with remote sensor 19 Spring to fix the remote sensor of the thermostatic head 20 Water load/drain tap 21 Brackets 22 Contact bimetallic safety thermostat 23 Cabinet with adjustable ends, RAL 9016 white frame and door 24 Check valve 25 Delivery manifold for primary side 26 Return manifold from primary circuit |
|---|---|

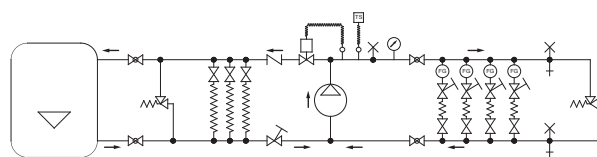
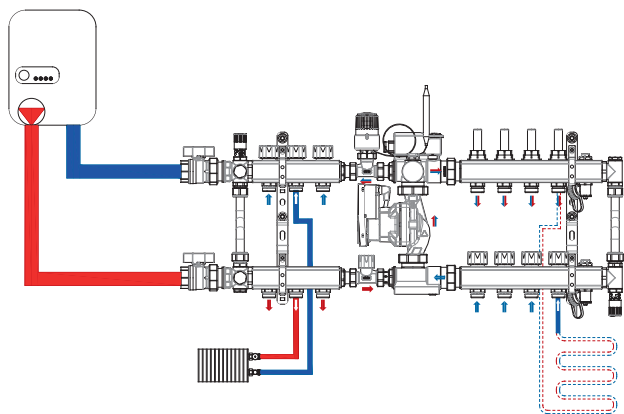

HYDRAULIC SCHEME LEGEND

	check valve		water load/drain tap		circulation pump
	ball valve		thermometer		user: radiant panels, radiators etc.
	non-return valve, the arrow indicates the direction of flow		manual air vent device		filter
	safety valve (bypass valve)		automatic air vent device		3-way valve
	check valve, regulation and balancing		flow meter		
	ball check valve regulation and balancing		immersion safety thermostat		
	injection valve with remote sensor		contact safety thermostat		

FUNCTION

The hot water coming from the boiler and the primary circuit enters the pump group GP 1190 through the lockshield valve of the kit KA 1191, which regulates the maximum quantity of medium inside the secondary circuit, thus balancing the primary one.

The outflowing water is regulated by the thermostatic adjustment valve. This valve is controlled by a thermostatic head with remote sensor which keeps the delivery water in the radiant panels at a constant pre-set temperature by mixing hot water coming from the boiler with the one circulating in the panels.

The system is complemented with a bypass valve both on the primary and the secondary circuit. In case of excessive differential pressure, the bypass valve releases the exceeding pressure, thus protecting the components and, if thermoelectric heads are employed to intercept the circuits, avoiding noise and wear on the circulation pump.

The intervention of the thermostat must block the functioning of the pump.

This type of system can supply a max thermal power of 14 kW with a Δt of 10°C and a temperature of ≥ 70 °C on the primary circuit.

**REGULATION SYSTEM FOR RADIANT PANELS HEATING WITH PUMP GROUP
GP 1190 AND KIT FOR HIGH TEMPERATURE KA 1191**



KA 1191

Kit for high temperature heating system. To combine with pump set GP 1190.

CODE	SIZE				€
72000040	G 1"	787	1	8	87,29



Depth
90 mm

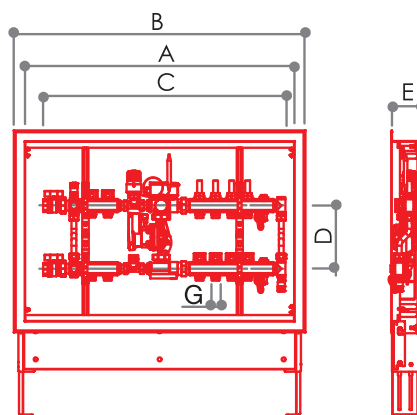

CCBAP 4024

Distribution system for low temperature heating + 2 connections for high temperature (W24x19).

ARTICLE	CODE	SIZE	N. PANEL CONNECTIONS	A	B	C	D	E	F	G		
CCBAP4024/2	17402402N	G 1" x (W24x19)	2	850	910	670	200	90		W24x19	24,648	1
CCBAP4024/3	17402403N		3	850	910	720					25,242	1
CCBAP4024/4	17402404N		4	850	910	770					25,836	1
CCBAP4024/5	17402405N		5	1000	1060	820					28,430	1
CCBAP4024/6	17402406N		6	1000	1060	870					29,024	1
CCBAP4024/7	17402407N		7	1000	1060	920					29,618	1
CCBAP4024/8	17402408N		8	1200	1260	970					32,212	1
CCBAP4024/9	17402409N		9	1200	1260	1020					32,806	1
CCBAP4024/10	17402410N		10	1200	1260	1070					33,400	1
CCBAP4024/11	17402411N		11	1200	1260	1120					33,994	1
CCBAP4024/12	17402412N		12	1300	1360	1170					36,588	1



Depth
90 mm

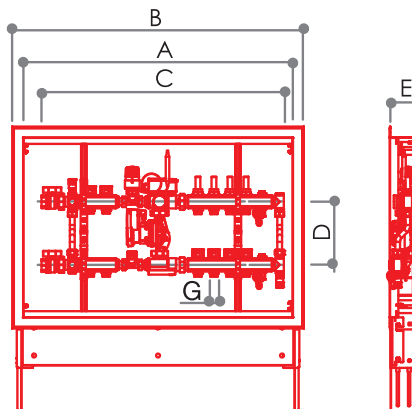

CCBAP 4023

Distribution system for low temperature heating + 3 connections for high temperature (W24x19).

ARTICLE	CODE	SIZE	N. PANEL CONNECTIONS	A	B	C	D	E	F	G		
CCBAP4023/2	17402302N	G 1" x (W24x19)	2	850	910	720	200	90	-	W24x19	25,218	1
CCBAP4023/3	17402303N		3	850	910	770			-		25,812	1
CCBAP4023/4	17402304N		4	1000	1060	820			-		28,406	1
CCBAP4023/5	17402305N		5	1000	1060	870			-		29,000	1
CCBAP4023/6	17402306N		6	1000	1060	920			-		29,594	1
CCBAP4023/7	17402307N		7	1200	1260	970			-		32,188	1
CCBAP4023/8	17402308N		8	1200	1260	1020			-		32,782	1
CCBAP4023/9	17402309N		9	1200	1260	1070			-		33,376	1
CCBAP4023/10	17402310N		10	1200	1260	1120			-		33,970	1
CCBAP4023/11	17402311N		11	1300	1360	1170			-		36,564	1
CCBAP4023/12	17402312N		12	1300	1360	1220			-		37,158	1



Depth
90 mm

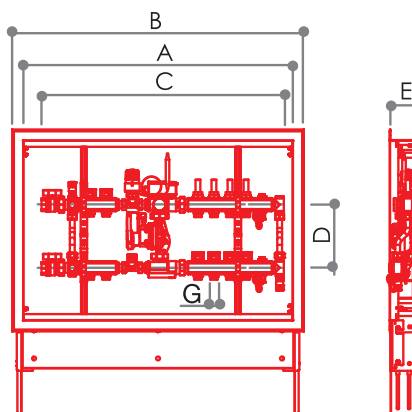

CCBAP 4034

Distribution system for low temperature heating + 2 connections for high temperature (G 3/4 EK).

ARTICLE	CODE	SIZE	N. PANEL CONNECTIONS	A	B	C	D	E	F	G		
CCBAP4034/2	17403402N	G 1" x G 3/4 EK	2	850	910	670	200	90	-	G 3/4 EK	24,648	1
CCBAP4034/3	17403403N		3	850	910	720			-		25,242	1
CCBAP4034/4	17403404N		4	850	910	770			-		25,836	1
CCBAP4034/5	17403405N		5	1000	1060	820			-		28,430	1
CCBAP4034/6	17403406N		6	1000	1060	870			-		29,024	1
CCBAP4034/7	17403407N		7	1000	1060	920			-		29,618	1
CCBAP4034/8	17403408N		8	1200	1260	970			-		32,212	1
CCBAP4034/9	17403409N		9	1200	1260	1020			-		32,806	1
CCBAP4034/10	17403410N		10	1200	1260	1070			-		33,400	1
CCBAP4034/11	17403411N		11	1200	1260	1120			-		33,994	1
CCBAP4034/12	17403412N		12	1300	1360	1170			-		36,588	1

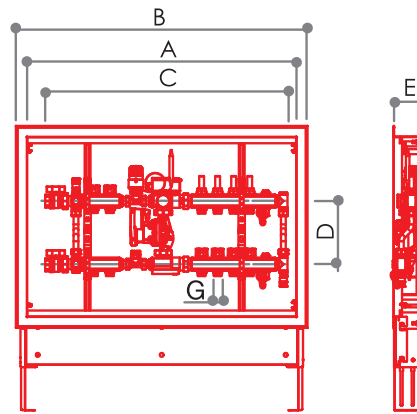

CCBAP 4033

Distribution system for low temperature heating + 3 connections for high temperature (G 3/4 EK).

ARTICLE	CODE	SIZE	N. PANEL CONNECTIONS	A	B	C	D	E	F	G		
CCBAP4033/2	17403302N	G 1" x G 3/4 EK	2	850	910	720	200	90	-	-	25,218	1
CCBAP4033/3	17403303N		3	850	910	770			-		25,812	1
CCBAP4033/4	17403304N		4	1000	1060	820			-		28,406	1
CCBAP4033/5	17403305N		5	1000	1060	870			-		29,000	1
CCBAP4033/6	17403306N		6	1000	1060	920			-		29,594	1
CCBAP4033/7	17403307N		7	1200	1260	970			-		32,188	1
CCBAP4033/8	17403308N		8	1200	1260	1020			-		32,782	1
CCBAP4033/9	17403309N		9	1200	1260	1070			-		33,376	1
CCBAP4033/10	17403310N		10	1200	1260	1120			-		33,970	1
CCBAP4033/11	17403311N		11	1300	1360	1170			-		36,564	1
CCBAP4033/12	17403312N		12	1300	1360	1220			-		37,158	1

FLOW RATE CHART

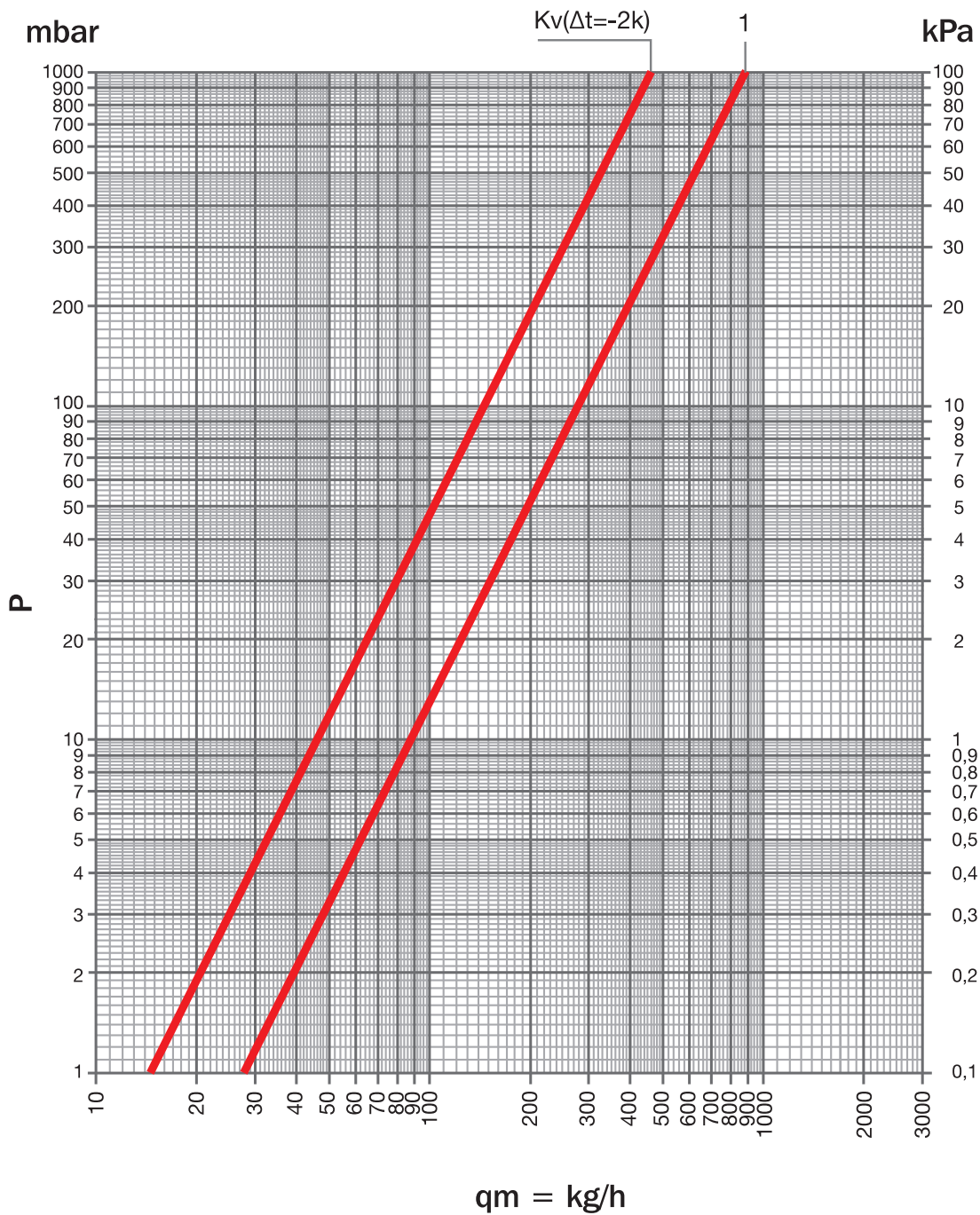

Kv	Kv Δt 2 °C	POS
0.88	0.46	1

REGULATION SYSTEMS FOR RADIANT PANELS HEATING WITH PUMP GROUP GP 1190 AND KIT FOR HIGH TEMPERATURE FM 750



20 kW

TECHNICAL DATA

Maximum working pressure 6 bar
 Maximum differential pressure 1 bar
 Maximum working temperature on primary circuit 80 °C
 Maximum working temperature on secondary circuit 70 °C
 Temperature range on secondary circuit 20 °C ÷ 65 °C
 Max thermal power 20 kW with Δt 10 °C
 and temperature on the primary circuit ≥ 70 °C

CONSTRUCTIVE FEATURES

Press-forged parts consist of brass with limited lead content in compliance with the current regulations: CW617N UNI EN 12165:2016. All o-rings are produced in peroxide cured EPDM. Stainless steel components in AISI 316. All components are provided with soft o-rings and do not require any intermediate sealing element (PTFE, hemp, etc.).

APPLICATIONS

When combined with pump group GP 1190, the kit for high temperature FM 750 allows to install a hot water distribution for traditional radiator systems and a water distribution system for radiant panels in one single cabinet.

COMPONENTS

- 1 Thermostatic head with remote sensor
- 2 Thermostatic mixing valve with third way in bypass
- 3 G 3/4 fitting with soft seal
- 4 G 1" fitting with soft seal
- 5 Female connection with flat gasket
- 6 Copper pipe for bypass
- 7 Compression fitting
- 8 Balancing valve

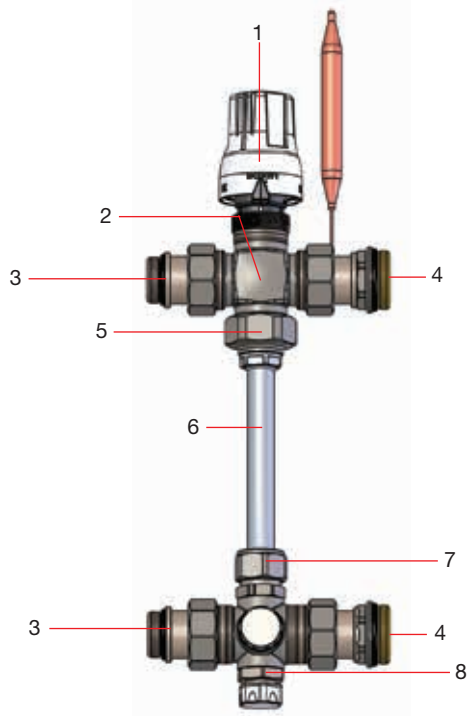

HYDRAULIC SCHEME

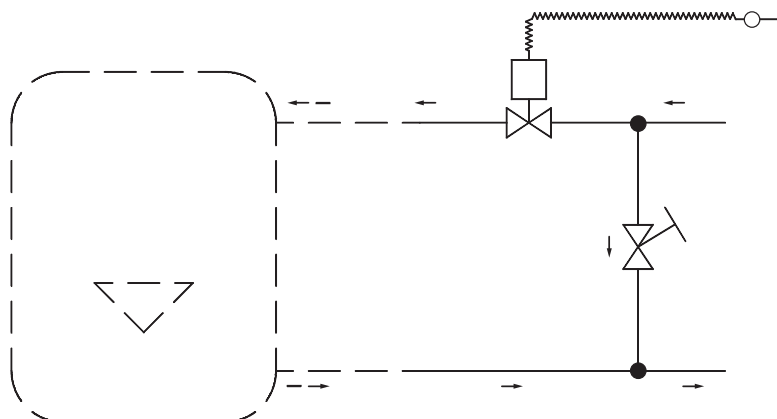

FUNCTION

The FM 750 system keeps the water in the radiant panels at a constant, pre-set temperature by mixing the hot water coming from the boiler with the one recirculating through the bypass circuit.

A thermostatic valve with remote sensor measures the temperature and adds hot water to the circuit accordingly, so as to compensate the heat output of the radiant panels.

The “Flow Mix” thermostatic mixer consists of a thermostatic mixing valve and a balancing valve. By means of a lockshield, the latter regulates the quantity of water returning from the radiant panels circuit to be sent to the low temperature connection of the mixer.

It is advisable to install a safety thermostat on the pump inlet valve, so as to avoid possible damage caused by a sudden temperature rise.

The intervention of the thermostat must block the functioning of the pump.

This type of system can supply a maximum thermal power of 20 kW with a Δt of 10°C and a temperature of $\geq 70^\circ\text{C}$ on the primary circuit.

The “Flow Mix” can be installed both on the left or right side of the Pump Group GP 1190.

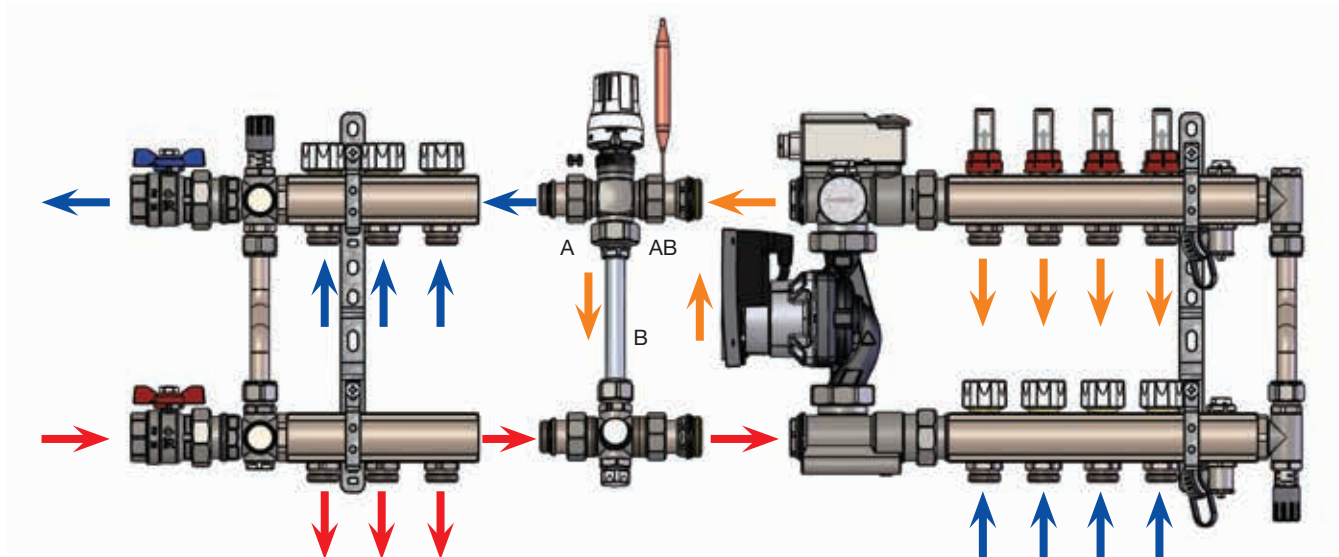

IN THE FIRST CASE

- The mixing valve AB way must be connected to the end part of the pump;
- The A way must be connected to the manifold of the high temperature zone;

- The B way is the bypass;
- The probe of the thermostatic head must be inserted in the top part of the pump group before installing the **Flow Mix**.

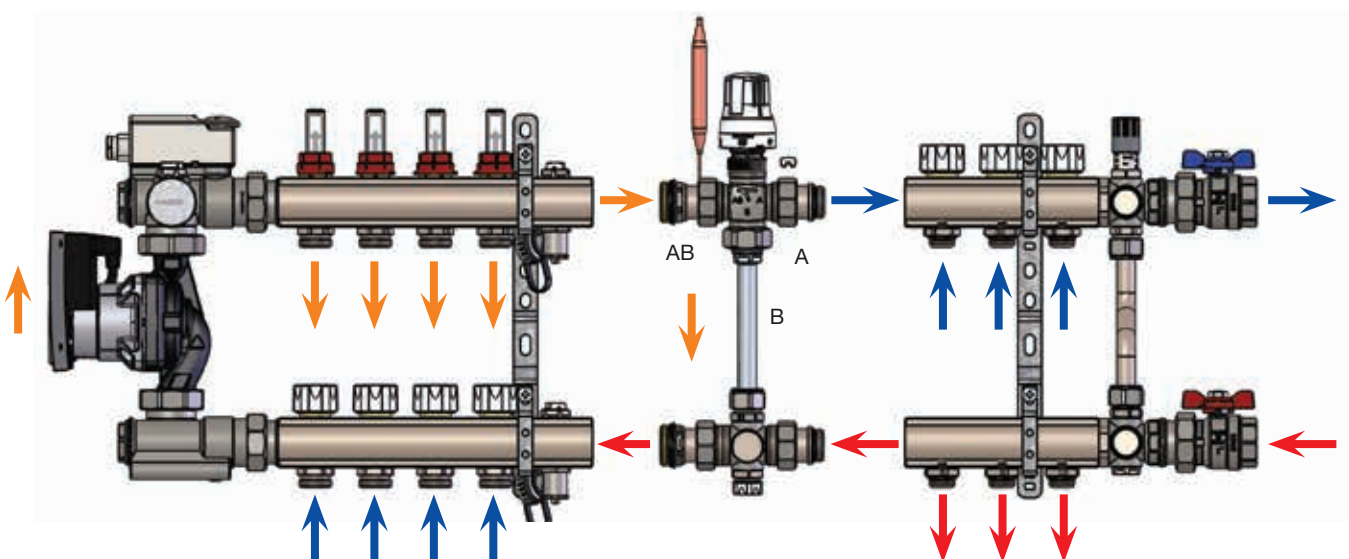

IN THE SECOND CASE

- The mixing valve AB must be connected to the end part of the inlet manifold of the low temperature zone;
- The A way must be connected to the return manifold of the high temperature zone;

- The B way is the bypass;
- The probe of the thermostatic head must be inserted in the top part of the pump group before installing the **Flow Mix**.

DIMENSIONAL DRAWING

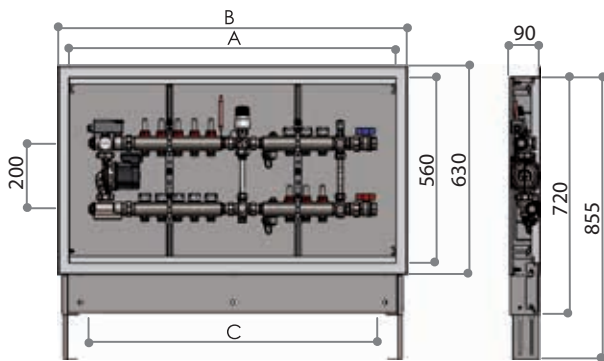
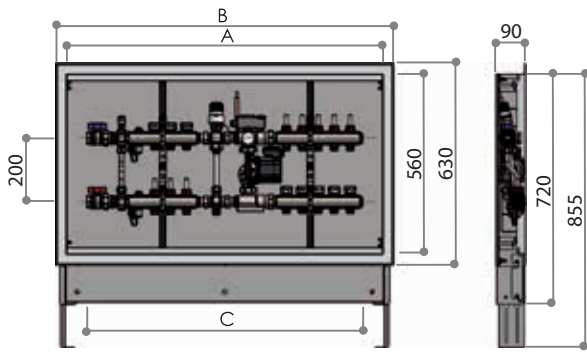

N. PANEL CONNECTIONS	A	B	C
WITH 2 WAYS FOR HIGH TEMPERATURE			
2	910	850	670
3	910	850	720
4	910	850	770
5	1060	1000	820
6	1060	1000	870
7	1060	1000	920
8	1260	1200	970
9	1260	1200	1020
10	1260	1200	1070
11	1260	1200	1120
12	1360	1300	1170
WITH 3 WAYS FOR HIGH TEMPERATURE			
2	910	850	720
3	910	850	770
4	1060	1000	820
5	1060	1000	870
6	1060	1000	920
7	1260	1200	970
8	1260	1200	1020
9	1260	1200	1070
10	1260	1200	1120
11	1360	1300	1170
12	1360	1300	1220

N. PANEL CONNECTIONS	A	B	C
WITH 2 WAYS FOR HIGH TEMPERATURE			
2	910	850	670
3	910	850	720
4	910	850	770
5	1060	1000	820
6	1060	1000	870
7	1060	1000	920
8	1260	1200	970
9	1260	1200	1020
10	1260	1200	1070
11	1260	1200	1120
12	1360	1300	1170
WITH 3 WAYS FOR HIGH TEMPERATURE			
2	910	850	720
3	910	850	770
4	1060	1000	820
5	1060	1000	870
6	1060	1000	920
7	1260	1200	970
8	1260	1200	1020
9	1260	1200	1070
10	1260	1200	1120
11	1360	1300	1170
12	1360	1300	1220

REGULATION SYSTEMS FOR RADIANT PANELS HEATING WITH PUMP GROUP GP 1190 AND KIT FOR HIGH TEMPERATURE

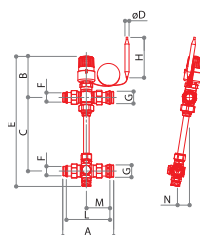

FM 750

Flow mix kit with bypass for mixed heating systems.

CODE	SIZE	A	B	C	D	E	F	G	H	L	M	N			
68763602	G 1"	138	115	200	11	365	G 3/4	G 1"	110	118	64	32	1442	1	8

FLOW RATE CHART

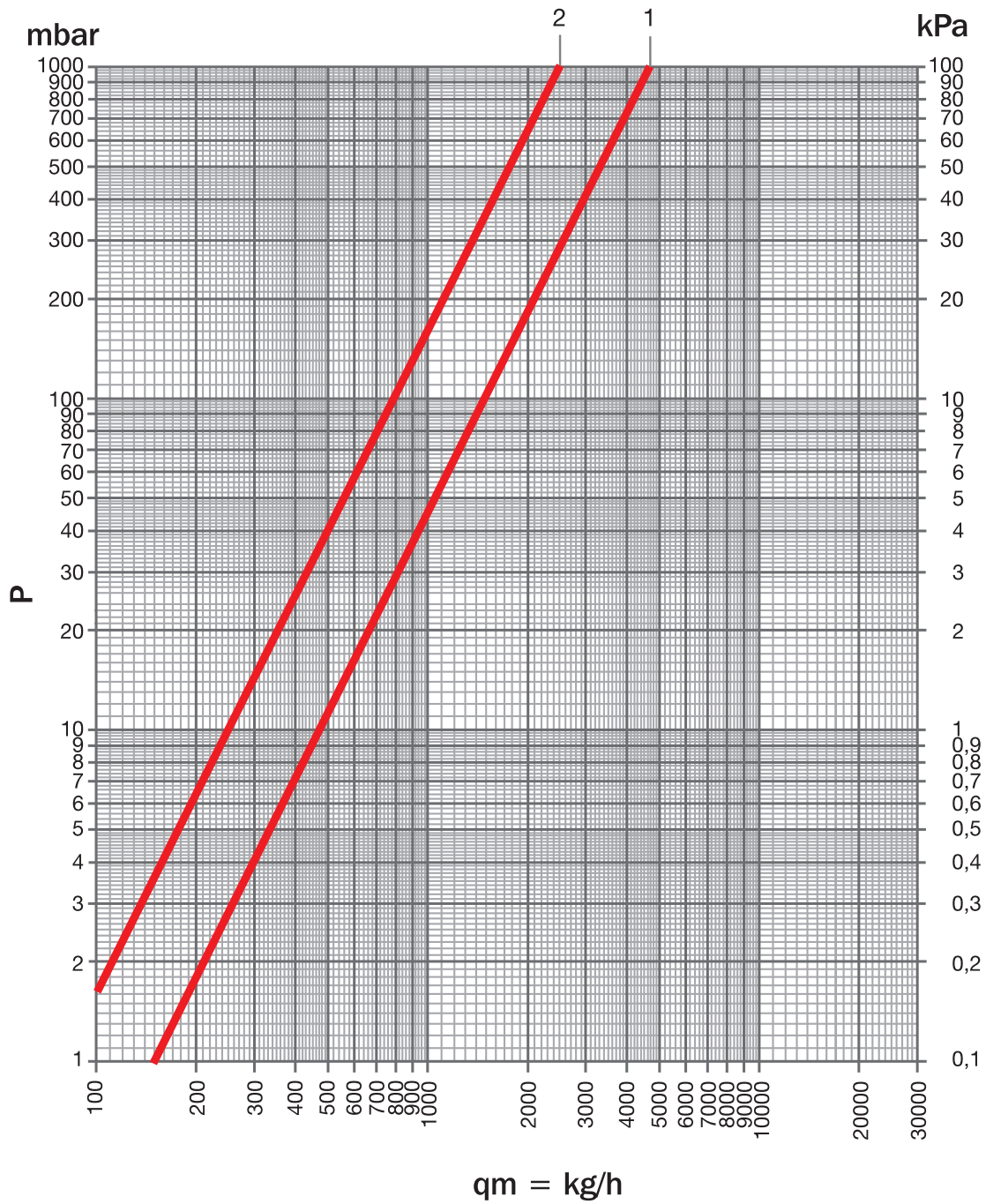

Kv	Kv Δt 2 °C		POS
4.70	0.36	A - AB way	1
2.50	-	B - AB way always open	2

REGULATION SYSTEMS FOR RADIANT PANELS HEATING WITH MIXING GROUP GM 1192



20 kW

TECHNICAL DATA

Maximum working pressure 6 bar
 Maximum differential pressure 1 bar
 Regulation range on the bypass $0.2 \div 0.7$ bar
 Maximum working temperature on primary circuit $80\text{ }^{\circ}\text{C}$
 Maximum working temperature on secondary circuit $70\text{ }^{\circ}\text{C}$
 Temperature range on secondary circuit $20\text{ }^{\circ}\text{C} \div 65\text{ }^{\circ}\text{C}$
 Maximum thermal power 20 kW with $\Delta t 10\text{ }^{\circ}\text{C}$
 and temperature on the primary circuit $\geq 70\text{ }^{\circ}\text{C}$

CONSTRUCTIVE FEATURES

Press-forged parts consist of brass with limited lead content in compliance with the current regulations: CW617N UNI EN 12165:2016. All o-rings are produced in peroxide cured EPDM. Stainless steel components in AISI 316.

All components are provided with soft o-rings and do not require any intermediate sealing element (PTFE, hemp, etc.). Side connections W24x19 or G 3/4 EK with 50 mm interaxis. The pump group GM 1192 as a $\varnothing 23$ mm internal passage.

APPLICATIONS

The mixing group GM 1192 is a regulation group which combines a number of components in a single device able to maintain a pre-set temperature in the radiant panels circuit of mixed heating systems. The temperature in the panels is kept constant by a regulating valve which mixes hot water coming from the boiler with the low temperature one circulating in the panels. The GM 1192 can be connected directly to Luxor manifolds for radiant panels by means of a G 1" male fitting

with soft seal. This makes the GM 1192 particularly convenient, since it can be kept in stock as a modular component.

Moreover, the GM 1192 makes mixed heating systems extremely flexible, since the regulation group can be adjusted to meet the future requirements of the secondary circuit. It is therefore possible to expand the radiant panels system simply by adding outlets, without temperature or pressure issues downstream of the group.

The GM 1192 can be set both to increase the heating capacity and to balance pressure drops.

Finally, thanks to its great regulation capacity, the GM 1192 allows to make the secondary circuit independent from the primary in case of replacement of important parts of the system, for example when a new boiler with a different operating principle is installed. By means of the bypass circuit, the circulation pump can keep on operating at design conditions. This type of system can supply a max thermal power of 20 kW with a temperature of the primary circuit of $\geq 70\text{ }^{\circ}\text{C}$.

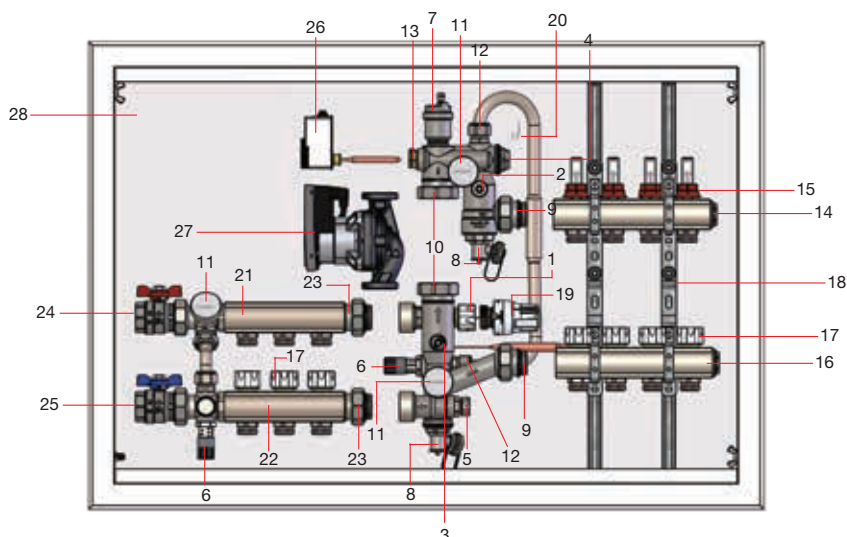

COMPONENTS

- 1 Regulating valve.
With piston-like screw; fits both thermostatic heads for fixed points and 0-10 Volt thermoelectric heads.
- 2 Pump shut-off valve.
Allows for interception in case of maintenance and replacement of the circulation pump without draining the system.
- 3 Ball valve for pump interception and balancing of the secondary circuit.
Allows to intercept the pump and balance pressure drops in the radiant panels secondary circuit and those caused by regulating valve "1" in the primary circuit. The regulation group GM 1192 is supplied with a balancing valve set $K_v=7$ for applications up to 11 Kw/h, if a higher capacity is required, set the valve to a lower K_v .
- 4 Probe seat.
- 5 Low temperature circuit shut-off valve.
Only set at first start-up to adjust the pressure drop of the water coming from the secondary circuit. To separate the primary and the secondary circuit for maintenance on the primary, the lockshield must be fully closed. A non-return valve inside the seat prevents the water in the primary circuit from heating up the mixing group when the pump is off and the thermostatic head is closed. This valve should usually be completely open.
- 6 Differential bypass valve.
Bypass valves are essential in all distribution systems with 2-way zone valves or heating bodies with adjustment valves, which enable, under certain circumstances, to bypass a circuit.
The recirculation guaranteed by the valve prevents the pump from working under improper conditions, thus avoiding imbalances among circuits operating in parallel and noise caused by the increased speed of the medium flowing through the adjustment devices.
- 7 Automatic air vent valve (1/2 connections).
Operates during the loading phase by discharging the air out of the group.
- 8 Load / drain taps with adjustable 3/4 connection and safety cap.
- 9 Three-pieces G 1" union fitting with soft sealing art. CR 498.
- 10 G 1" 1/2 adapters to connect the circulation pump.
- 11 Thermometers, measurement range 0°C to 80°C.
Allow to check water temperature in the delivery and return manifolds of the radiant panels in the secondary circuit.
- 12 Union fittings for bypass pipe.
- 13 Safety thermostat seat.
- 14 Delivery manifold (radiant panels).
- 15 Regulators and flow meters, capacity 0.5 l/m to 5 l/m.
The glass can be removed for cleaning while the system is operating.
- 16 Return manifold (radiant panels).
- 17 Valves for electrothermal regulation, with protection caps.
- 18 Brackets.
- 19 Thermostatic head with remote sensor.
- 20 Spring to fix the remote sensor to the thermostatic head.
- 21 Delivery manifold (primary circuit).
- 22 Return manifold (primary circuit).
- 23 Three-pieces G 1" union fitting with soft sealing.
- 24 Delivery ball valve (boiler).
- 25 Return ball valve (boiler).
- 26 Contact safety thermostat.
- 27 Circulation pump with 25/60 synchronous motor, interaxis 130 mm, energy class A.
25/60 wheelbase 130 mm energy class A.
- 28 Cabinet with adjustable ends, RAL 9016 white frame and door.

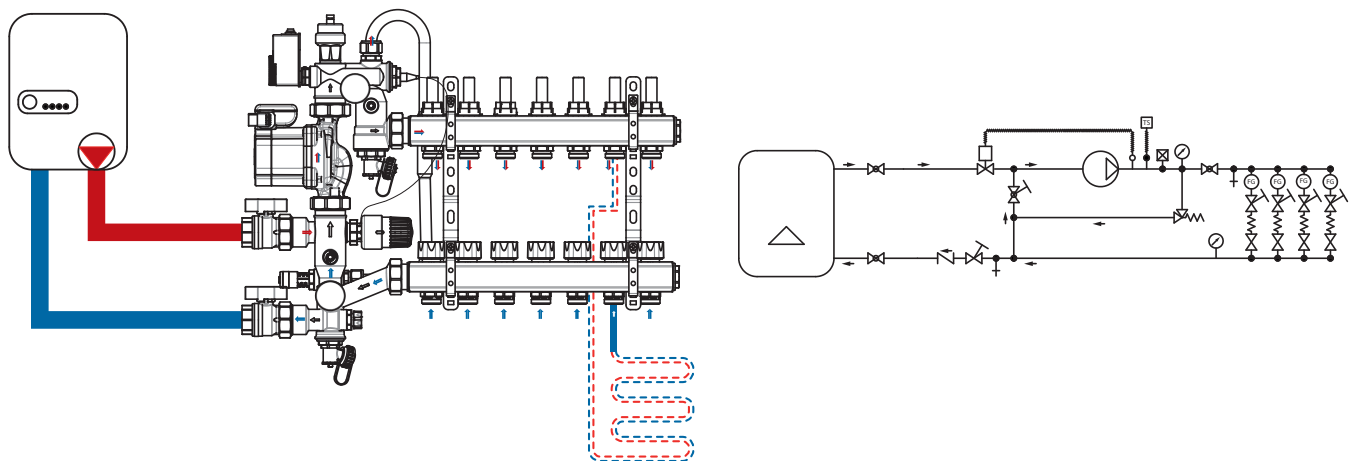

HYDRAULIC SCHEME LEGEND

	check valve		water load/drain tap		circulation pump
	ball valve		thermometer		user: radiant panels, radiators etc.
	non-return valve, the arrow indicates the direction of flow		manual air vent device		filter
	safety valve (bypass valve)		automatic air vent device		3-way valve
	check valve, regulation and balancing		flow meter		
	ball check valve regulation and balancing		immersion safety thermostat		
	injection valve with remote sensor		contact safety thermostat		

FUNCTION

Fixed point heating systems keep the water in the radiant panels at a constant pre-set temperature by mixing hot water coming from the boiler with the one circulating in the panels. A thermostatic valve with remote sensor measures the temperature and adds hot water to the circuit accordingly, so as to compensate the heat output of the radiant panels. It is advisable to install a security thermostat on the pump inlet valve in order to avoid damages caused by a sudden temperature rise. The intervention of the thermostat must block the functioning of the pump.

The system can be complemented with a bypass valve. In case of excessive differential pressure, the bypass valve releases the exceeding pressure, thus protecting the components and, if thermoelectric heads are employed to intercept the circuits, avoiding noise and wear on the circulation pump. This type of system can supply a max thermal power of 20 kW with a Δt of 10°C and a temperature of $\geq 70^\circ\text{C}$ on the primary side.

REGULATION SYSTEMS FOR RADIANT PANELS HEATING WITH MIXING GROUP GM 1192



GM 1192

Fixed point regulation group for floor heating systems, with connection for pump with thermostatic head.

CODE	SIZE			
72000050	CD G 1" x 130 mm	4580	-	1
72000050X	CX G 1" X 130 mm	4744	-	1
72000055	CD G 1" x 180 mm	4610	-	1



GM 1193

Regulation group for floor heating systems, with pump connection.

CODE	SIZE			
72000052	G 1" x 130 mm	4434	-	1
72000057	G 1" x 180 mm	4464	-	1



CB 1200

Insulation for regulation group GM 1192, with 130 mm pump connection.

CODE	SIZE			
72000060	-	192	2	-



CB 1205

Insulation for manifolds CD series, for 12 ways.

CODE	SIZE			
72000064	CD G 1"	156	-	6
72000066	CX G 1"	149	-	6
72000065	CD G 1"1/4	180	-	6

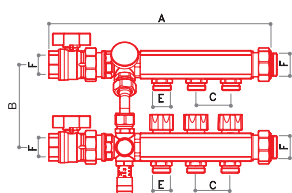
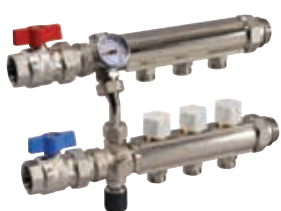

CD 4071

Kit for high temperature for mixing group art. GM 1192.

CODE	ARTICLE	SIZE	A	B	C	D	E	F	G	H			
17407102N	CD4071/2	G 1" x (W24x19)	275	120	25	-	W24x19	G 1"	-	-	3490	1	-
17407103N	CD4071/3		325	120	25	-	W24x19	G 1"	-	-	4050	1	-
17407104N	CD4071/4		375	120	25	-	W24x19	G 1"	-	-	4610	1	-

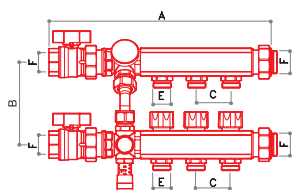

CD 4072

Kit for high temperature for mixing group art. GM 1192.

CODE	ARTICLE	SIZE	A	B	C	D	E	F	G	H			
17407202N	CD4072/2	G 1" x G 3/4 EK	275	120	25	-	G 3/4 EK	G 1"	-	-	3534	1	-
17407203N	CD4072/3		325	120	25	-	G 3/4 EK	G 1"	-	-	4116	1	-
17407204N	CD4072/4		375	120	25	-	G 3/4 EK	G 1"	-	-	4698	1	-

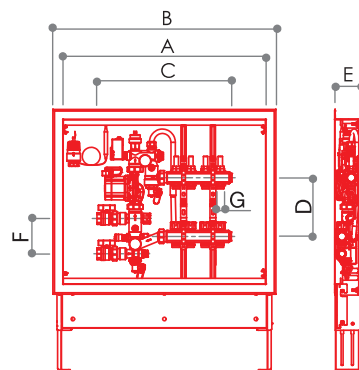
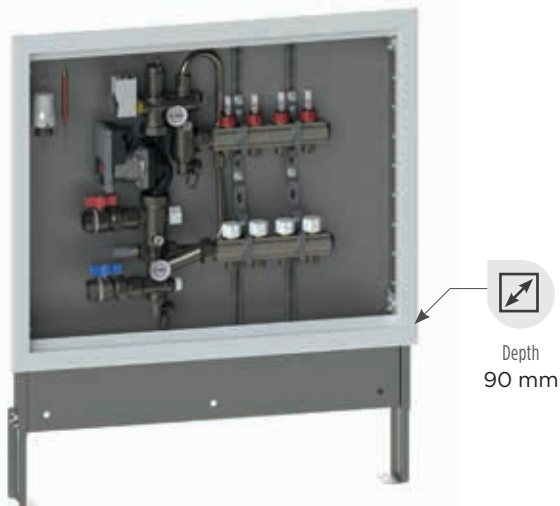

CCBP 4026

Fixed point heating system for low temperature (W24x19).

ARTICLE	CODE	SIZE	N. PANEL CONNECTIONS	A	B	C	D	E	F	G	H	L		
CCBP4026/2	17402602N	G 1" x (W24x19)	2	500	560	360	200	90	120	W24x19	-	-	19,218	1
CCBP4026/3	17402603N		3	700	760	410					-	-	21,812	1
CCBP4026/4	17402604N		4	700	760	460					-	-	22,406	1
CCBP4026/5	17402605N		5	700	760	510					-	-	23,00	1
CCBP4026/6	17402606N		6	700	760	560					-	-	23,594	1
CCBP4026/7	17402607N		7	850	910	610					-	-	26,188	1
CCBP4026/8	17402608N		8	850	910	660					-	-	26,782	1
CCBP4026/9	17402609N		9	850	910	710					-	-	27,376	1
CCBP4026/10	17402610N		10	1000	1060	760					-	-	29,970	1
CCBP4026/11	17402611N		11	1000	1060	810					-	-	30,564	1
CCBP4026/12	17402612N		12	1000	1060	860					-	-	31,158	1
CCBP4026/13	17402613N		13	1200	1260	910					-	-	33,758	1

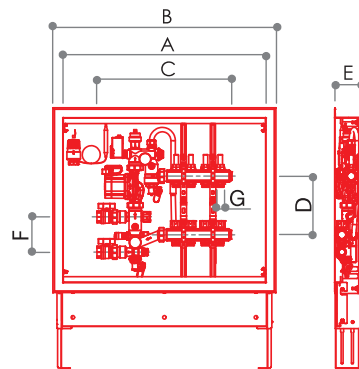
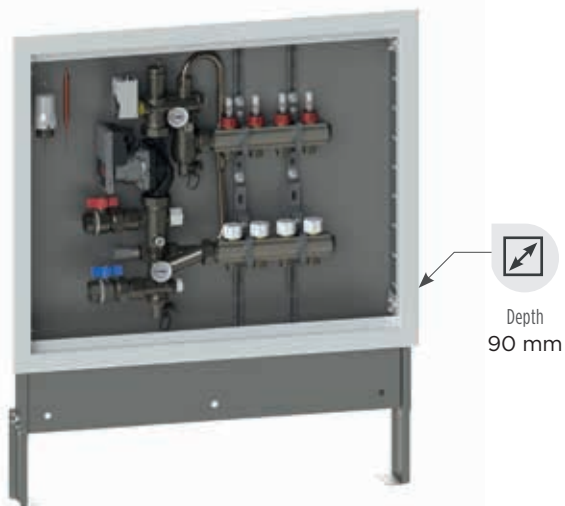

CCBP 4036

Fixed point heating system for low temperature G 3/4 EK.

ARTICLE	CODE	SIZE	N. PANEL CONNECTIONS	A	B	C	D	E	F	G	H	L		
CCBP4036/2	17403602N	G 1" x G 3/4 EK	2	500	560	360	200	90	120	G 3/4 EK	-	-	19,218	1
CCBP4036/3	17403603N		3	700	760	410					-	-	21,812	1
CCBP4036/4	17403604N		4	700	760	460					-	-	22,406	1
CCBP4036/5	17403605N		5	700	760	510					-	-	23,000	1
CCBP4036/6	17403606N		6	700	760	560					-	-	23,594	1
CCBP4036/7	17403607N		7	850	910	610					-	-	26,188	1
CCBP4036/8	17403608N		8	850	910	660					-	-	26,782	1
CCBP4036/9	17403609N		9	850	910	710					-	-	27,376	1
CCBP4036/10	17403610N		10	1000	1060	760					-	-	29,970	1
CCBP4036/11	17403611N		11	1000	1060	810					-	-	30,564	1
CCBP4036/12	17403612N		12	1000	1060	860					-	-	31,158	1
CCBP4036/13	17403613N		13	1200	1260	910					-	-	33,758	1

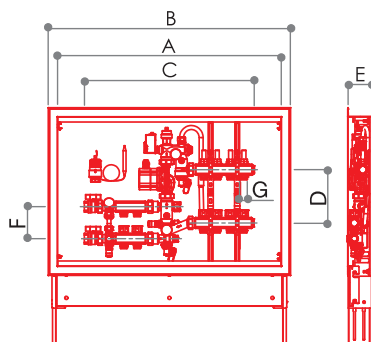
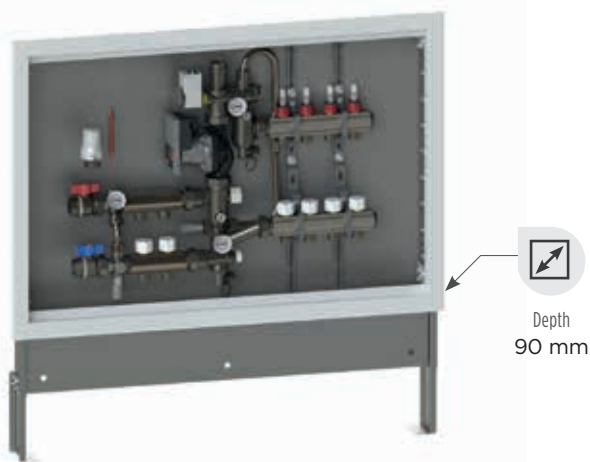

CCBAP 4025

Low temperature distribution system
+ 2 connections for high temperature (W24x19).

ARTICLE	CODE	SIZE	N. PANEL CONNECTIONS	A	B	C	D	E	F	G	H	L	kg	⊞
CCBAP4025/2	17402502N	G 1" x (W24x19)	2	700	760	540	200	90	120	W24x19	-	-	23,648	1
CCBAP4025/3	17402503N		3	700	760	590					-	-	24,242	1
CCBAP4025/4	17402504N		4	850	910	640					-	-	26,836	1
CCBAP4025/5	17402505N		5	850	910	690					-	-	27,430	1
CCBAP4025/6	17402506N		6	850	910	740					-	-	28,024	1
CCBAP4025/7	17402507N		7	1000	1060	790					-	-	30,618	1
CCBAP4025/8	17402508N		8	1000	1060	840					-	-	31,212	1
CCBAP4025/9	17402509N		9	1000	1060	890					-	-	31,806	1
CCBAP4025/10	17402510N		10	1200	1260	940					-	-	34,400	1
CCBAP4025/11	17402511N		11	1200	1260	990					-	-	34,994	1
CCBAP4025/12	17402512N		12	1200	1260	1040					-	-	35,588	1
CCBAP4025/13	17402513N		13	1200	1260	1090					-	-	36,182	1

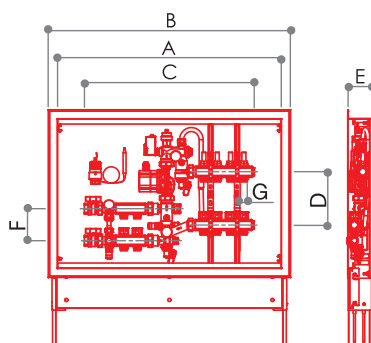
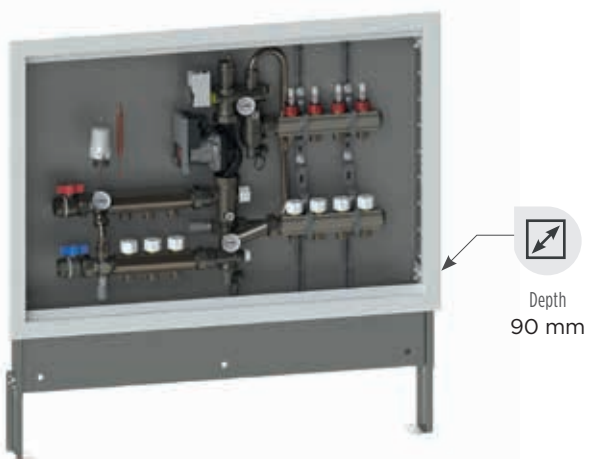

CCBAP 4027

Low temperature distribution system
+ 3 connections for high temperature (W24x19).

ARTICLE	CODE	SIZE	N. PANEL CONNECTIONS	A	B	C	D	E	F	G	H	L	kg	⊞
CCBAP4027/2	17402702N	G 1" x (W24x19)	2	700	760	590	200	90	120	W24x19	-	-	24,218	1
CCBAP4027/3	17402703N		3	850	910	640					-	-	26,812	1
CCBAP4027/4	17402704N		4	850	910	690					-	-	27,406	1
CCBAP4027/5	17402705N		5	850	910	740					-	-	28,000	1
CCBAP4027/6	17402706N		6	1000	1060	790					-	-	30,594	1
CCBAP4027/7	17402707N		7	1000	1060	840					-	-	31,188	1
CCBAP4027/8	17402708N		8	1000	1060	890					-	-	31,782	1
CCBAP4027/9	17402709N		9	1200	1260	940					-	-	34,376	1
CCBAP4027/10	17402710N		10	1200	1260	990					-	-	34,970	1
CCBAP4027/11	17402711N		11	1200	1260	1040					-	-	35,564	1
CCBAP4027/12	17402712N		12	1200	1260	1090					-	-	36,158	1
CCBAP4027/13	17402713N		13	1300	1360	1140					-	-	38,752	1



Depth
90 mm

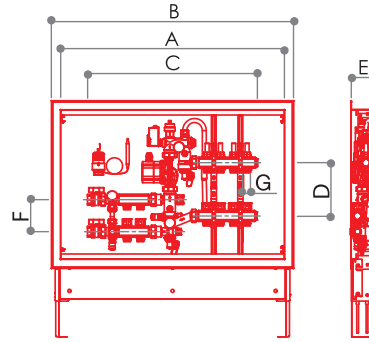

CCBAP 4079

Low temperature distribution system
+ 4 connections for high temperature
(W24x19).

ARTICLE	CODE	SIZE	N. PANEL CONNECTIONS	A	B	C	D	E	F	G	H	L	kg	box
CCBAP4079/2	17407902N	G 1" x (W24x19)	2	850	910	640	200	90	120	W24x19	-	-	24,788	1
CCBAP4079/3	17407903N		3	850	910	690					-	-	27,382	1
CCBAP4079/4	17407904N		4	850	910	740					-	-	27,976	1
CCBAP4079/5	17407905N		5	1000	1060	790					-	-	28,570	1
CCBAP4079/6	17407906N		6	1000	1060	840					-	-	31,164	1
CCBAP4079/7	17407907N		7	1000	1060	890					-	-	31,758	1
CCBAP4079/8	17407908N		8	1200	1260	940					-	-	32,352	1
CCBAP4079/9	17407909N		9	1200	1260	990					-	-	34,946	1
CCBAP4079/10	17407910N		10	1200	1260	1040					-	-	35,540	1
CCBAP4079/11	17407911N		11	1200	1260	1090					-	-	36,134	1
CCBAP4079/12	17407912N		12	1300	1360	1140					-	-	36,728	1
CCBAP4079/13	17407913N		13	1300	1360	1190					-	-	39,322	1



Depth
90 mm

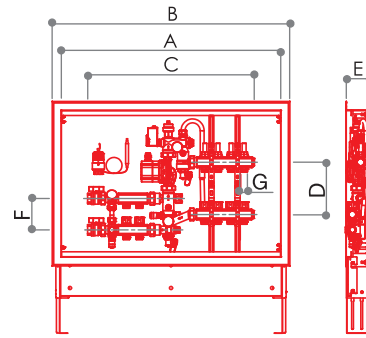

CCBAP 4035

Low temperature distribution system
+ 2 connections for high temperature
G 3/4 EK.

ARTICLE	CODE	SIZE	N. PANEL CONNECTIONS	A	B	C	D	E	F	G	H	L	kg	box
CCBAP4035/2	17403502N	G 1" x G 3/4 EK	2	700	760	540	200	90	120	G 3/4 EK	-	-	23,648	1
CCBAP4035/3	17403503N		3	700	760	590					-	-	24,242	1
CCBAP4035/4	17403504N		4	850	910	640					-	-	26,836	1
CCBAP4035/5	17403505N		5	850	910	690					-	-	27,430	1
CCBAP4035/6	17403506N		6	850	910	740					-	-	28,024	1
CCBAP4035/7	17403507N		7	1000	1060	790					-	-	30,618	1
CCBAP4035/8	17403508N		8	1000	1060	840					-	-	31,212	1
CCBAP4035/9	17403509N		9	1000	1060	890					-	-	31,806	1
CCBAP4035/10	17403510N		10	1200	1260	940					-	-	34,400	1
CCBAP4035/11	17403511N		11	1200	1260	990					-	-	34,994	1
CCBAP4035/12	17403512N		12	1200	1260	1040					-	-	35,588	1
CCBAP4035/13	17403513N		13	1200	1260	1090					-	-	36,182	1

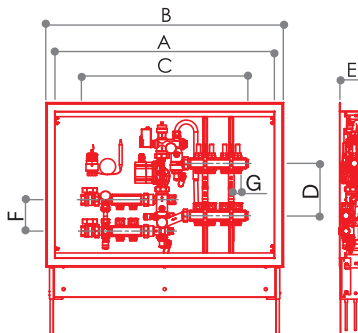
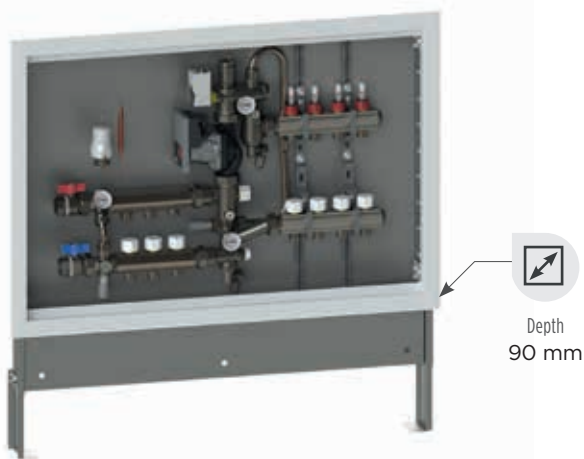

CCBAP 4037

Low temperature distribution system
+ 3 connections for high temperature
G 3/4 EK.

ARTICLE	CODE	SIZE	N. PANEL CONNECTIONS	A	B	C	D	E	F	G	H	L	kg	⇒
CCBAP4037/2	17403702N	G 1" x G 3/4 EK	2	700	760	590	200	90	120	G 3/4 EK	-	-	24,218	1
CCBAP4037/3	17403703N		3	850	910	640					-	-	26,812	1
CCBAP4037/4	17403704N		4	850	910	690					-	-	27,406	1
CCBAP4037/5	17403705N		5	850	910	740					-	-	28,000	1
CCBAP4037/6	17403706N		6	1000	1060	790					-	-	30,594	1
CCBAP4037/7	17403707N		7	1000	1060	840					-	-	31,188	1
CCBAP4037/8	17403708N		8	1000	1060	890					-	-	31,782	1
CCBAP4037/9	17403709N		9	1200	1260	940					-	-	34,376	1
CCBAP4037/10	17403710N		10	1200	1260	990					-	-	34,970	1
CCBAP4037/11	17403711N		11	1200	1260	1040					-	-	35,564	1
CCBAP4037/12	17403712N		12	1200	1260	1090					-	-	36,158	1
CCBAP4037/13	17403713N		13	1300	1360	1140					-	-	38,752	1

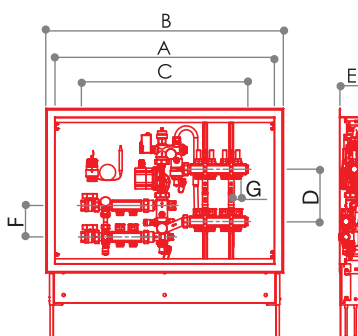
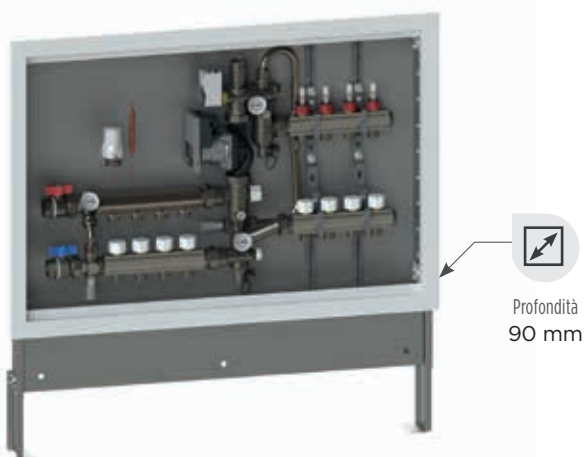

CCBAP 4080

Low temperature distribution system
+ 4 connections for high temperature
G 3/4 EK.

ARTICLE	CODE	SIZE	N. PANEL CONNECTIONS	A	B	C	D	E	F	G	H	L	kg	⇒
CCBAP4080/2	17408002N	G 1" x G 3/4 EK	2	850	910	640	200	90	120	G 3/4 EK	-	-	24,788	1
CCBAP4080/3	17408003N		3	850	910	690					-	-	27,382	1
CCBAP4080/4	17408004N		4	850	910	740					-	-	27,976	1
CCBAP4080/5	17408005N		5	1000	1060	790					-	-	28,570	1
CCBAP4080/6	17408006N		6	1000	1060	840					-	-	31,164	1
CCBAP4080/7	17408007N		7	1000	1060	890					-	-	31,758	1
CCBAP4080/8	17408008N		8	1200	1260	940					-	-	32,352	1
CCBAP4080/9	17408009N		9	1200	1260	990					-	-	34,946	1
CCBAP4080/10	17408010N		10	1200	1260	1040					-	-	35,540	1
CCBAP4080/11	17408011N		11	1200	1260	1090					-	-	36,134	1
CCBAP4080/12	17408012N		12	1300	1360	1140					-	-	36,728	1
CCBAP4080/13	17408013N		13	1300	1360	1190					-	-	39,322	1

SOLAR PUMP GROUP



TECHNICAL DATA

Maximum continuous working temperature 130°C
 Flow restrictor range 0.5 ÷ 15 l/min
 Thermometer range 0 ÷ 160 °C
 Relief valve set pressure 6 bar
 Pressure gauge range 0 ÷ 16 bar
 Working medium water and glycol (max 50%)

TECHNICAL DATA OF THE CIRCULATOR

Grundfos Solar Model 15-65 130
 Connection 1" M with flat sealing
 Interaxis 130 mm
 Temperature class TF 110
 Max peak temperature 140 °C
 Max working pressure 10 bar

CONSTRUCTIVE FEATURES

Press-forged parts consist of brass with limited lead content in compliance with the current regulations: CW617N UNI EN 12165:2016.

All o-rings are produced in peroxide cured EPDM. Gaskets are in carbon/graphite filled PTFE G415 and the insulation shells in black PPE (40 kg/m³).

All components are provided with soft o-rings and do not require any intermediate sealing element (PTFE, hemp, etc.).

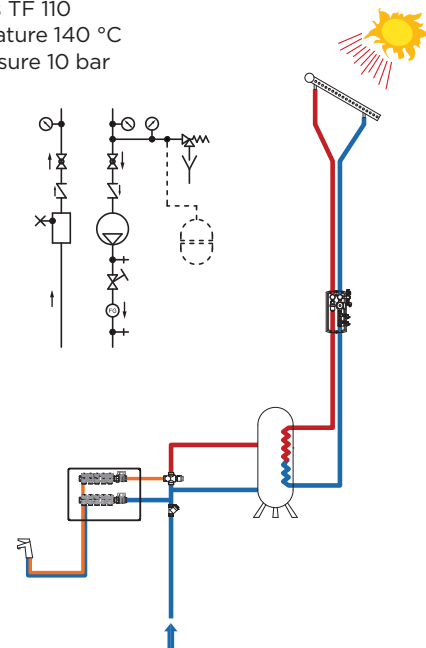

HYDRAULIC SCHEME LEGEND

	check valve		water load/drain tap		circulation pump
	ball valve		thermometer		user: radiant panels, radiators etc.
	non-return valve, the arrow indicates the direction of flow		manual air vent device		filter
	safety valve (bypass valve)		automatic air vent device		3-way valve
	check valve, regulation and balancing		flow meter		
	ball check valve regulation and balancing		immersion safety thermostat		
	injection valve with remote sensor		contact safety thermostat		

FUNCTION

The solar pump groups use the solar thermal energy and transfer this to a fluid heat carrier which then releases it to the water necessary for the system.

The groups are supplied with a pump which circulates the fluid inside the system. All the components of the system are produced in materials suitable to support the high temperatu-

re reached by the system.

The groups are also equipped with interception valve for the pump, loading and unloading valves, safety valves, flow-meter and protection cover.

The air separator/eliminator is only in model GSP 1180.

SOLAR PUMP GROUP

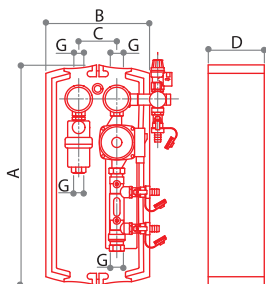

CSP 1180

Solar pump group complete with shut-off valves with built-in thermometers, deaerator, load/drain taps, check valves, 6 bar relief valve, insulation and flow meter with range 0,5 to 15 l/min.

Max working temperature 130 °C.

CODE	SIZE	A	B	C	D	E	F	G	H	L			
72000010	G 3/4	440	250	125	115	-	-	G 3/4	-	-	5028	1	-

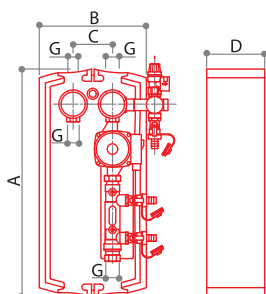

CSP 1182

Solar pump group complete with shut-off valves with built-in thermometers, load/drain taps, check valves, 6 bar relief valve, insulation and flow meter with range 0,5 to 15 l/min.

Max working temperature 130 °C.

CODE	SIZE	A	B	C	D	E	F	G	H	L			
72000012	G 3/4	440	250	125	115	-	-	G 3/4	-	-	4478	1	-



CE 1370

Digital differential control unit for solar heating systems.

CODE	SIZE			
69011470	-	530	1	-



AC 1180

Accessories for the connection between the solar pump groups and the expansion tank, complete with bidirectional check valve and bracket for wall fixing.

CODE	SIZE			
68559880	G 3/4	1116	1	-

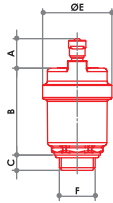

VS 604/S

Automatic air vent valve 200°C - 10 bar.



Testing 100%

CODE	SIZE	A	B	C	D	E	F	G	H	L			
67791017	G 3/8	17	50	9	-	40	G 3/8	-	-	-	138	10	100
67791021	G 1/2	17	50	9	-	40	G 1/2	-	-	-	138	10	100

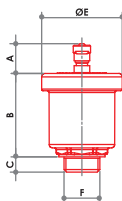

VS 601/S

Automatic air vent valve medium. 200°C - 10 bar.



Testing 100%

CODE	SIZE	A	B	C	D	E	F	G	H	L			
67790817	G 3/8	17	50	9	-	46	G 3/8	-	-	-	154	10	100
67790821	G 1/2	17	50	9	-	46	G 1/2	-	-	-	154	10	100
67790827	G 3/4	17	50	9	-	46	G 3/4	-	-	-	154	10	100

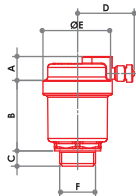

VS 603/S

Automatic air vent valve with lateral purge 200°C - 10 bar.



Testing 100%

CODE	SIZE	A	B	C	D	E	F	G	H	L			
67790917	G 3/8	14	41	9	34	40	G 3/8	-	-	-	160	10	100
67790921	G 1/2	14	41	9	34	40	G 1/2	-	-	-	160	10	100

FLOW RATE CHART

REGULATING VALVE WITH THERMOSTATIC HEAD

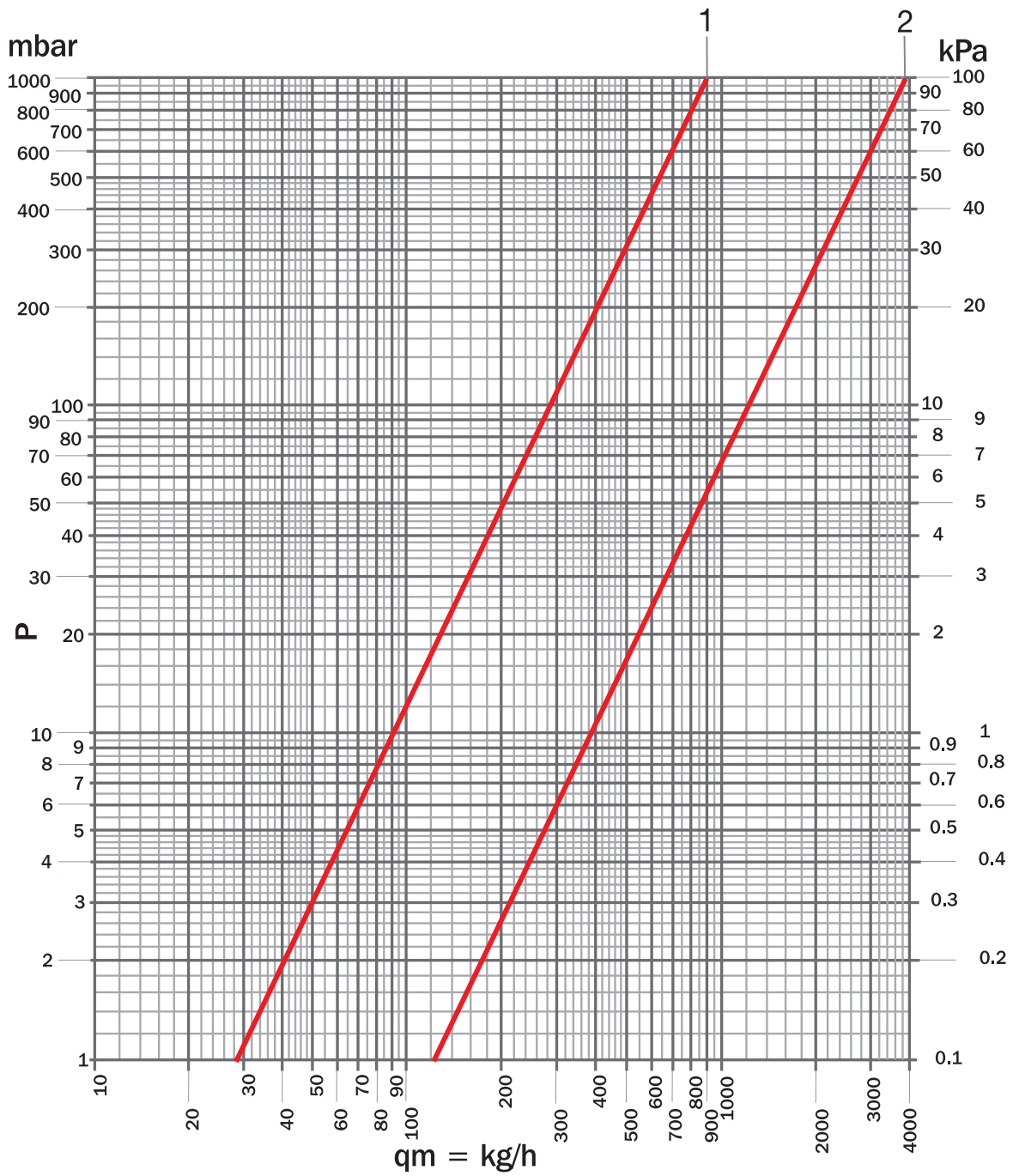

Kvs	REGULATION	POS
0,9	$\Delta T=2$ K	1
3,88	QM MAX	2

FLOW RATE CHART

SHUT-OFF VALVE

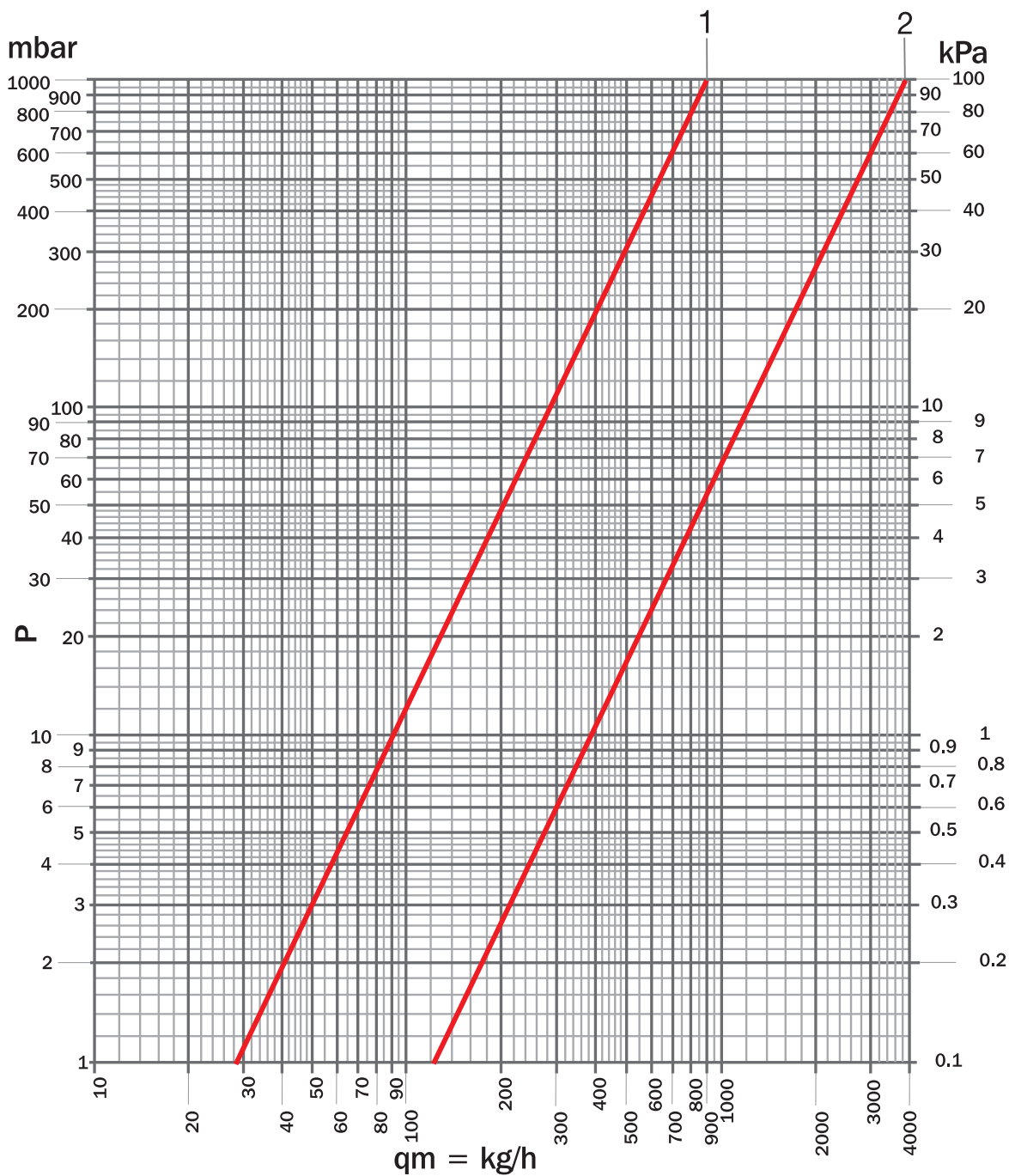

Kvs	REGULATION	POS
0,09	01/2	1
0,27	1	2
0,76	1+1/2	3
0,98	2	4
1,20	2+1/2	5
1,46	3	6
1,70	3+1/2	7
1,93	4	8
2,19	4+1/2	9
2,47	5	10
2,75	5+1/2	11
3,01	all open	12



LUXOR®

5 / ELECTRICAL AND ELECTRONIC ACCESSORIES

THERMOELECTRIC HEADS



TECHNICAL DATA

Thermoelectric heads function by exploiting the expansion of a thermosensitive element, which is heated up through an electrical resistor when the valve needs to be opened.

This allows for a slow open/close cycle and protects the system against water hammer.

Thermoelectric heads can only be connected to on/off thermostats or chronothermostats. Do not use 3-point or modulating thermostats or chronothermostats. TE thermoelectric heads are of the normally closed type, so they only open when

an opening input (voltage) comes from the control sensor (ex. thermostat).

This allows the head to work only when there is a need for hot or cold water to flow through the heating body, and to remain idle for the rest of the time.

The new thermoelectric heads can be installed in any position, even upside down, since they are secured against leakage from the thermostatic screws.

	TE 3010	TE 3011	TE 3012	TE 3013
supply voltage	230 V AC, +10%...-10%, 50/60 Hz	24 V AC/DC, +20%...-10%	230 V AC, +10%...-10%, 50/60 Hz	24 V AC/DC, +20%...-10%
max input current	<550 mA per max 100 ms	<300 mA per max 2 min	<550 mA per max 100 ms	<300 mA per max 2 min
operating power	1 W	1 W	1 W	1 W
stroke	3.5 mm	3.5 mm	3.5 mm	3.5 mm
actuating force	90 N +10%	90 N +10%	90 N +10%	90 N +10%
micro-switch voltage	-	-	230 V AC: resistive load, 5 A, inductive load 1 A	24 V AC: resistive load 3 A, inductive load 1 A
micro-switch trigger point	-	-	Ca. 2 mm	Ca. 2 mm
liquid temperature	0÷100 °C	0÷100 °C	0÷100 °C	0÷100 °C
storage temperature	-25÷60 °C	-25÷60 °C	-25÷60 °C	-25÷60 °C
room temperature	0÷60 °C	0÷60 °C	0÷60 °C	0÷60 °C
protection degree	IP 54	IP 54	IP 54	IP 54
protection class	II	III	II	III
CE conformity	EN 60730	EN 60730	EN 60730	EN 60730
housing material	Polyamide			
housing colour	Light grey RAL 7035			
connecting cable	2x0.75 mm ² PVC	2x0.75 mm ² PVC	4x0.75 mm ² PVC	4x0.75 mm ² PVC
cable colour	Light grey RAL 7035			
cable length	1 m	1 m	1 m	1 m
weight	100 g	100 g	Ca. 150 g	Ca. 150 g
overvoltage resistance according to EN 60730-1	2.5 kV	1 kV	2.5 kV	1 kV

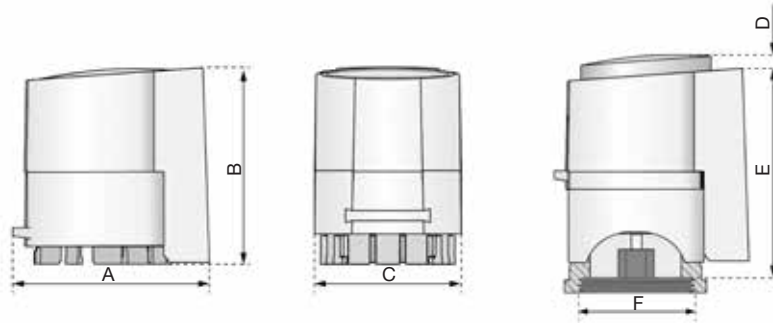

CODE	SIZE	A	B	C	D	E	F	G	H	L
69011051	M30x1,5	49	47,5	36	7	51	M30x1,5	-	-	-
69011052		49	47,5	36	7	51		-	-	-
69011056		59	50	36	7	53,5		-	-	-
69011057		59	50	36	7	53,5		-	-	-

CHARACTERISTIC CURVES

TE 3010 - TE 3011

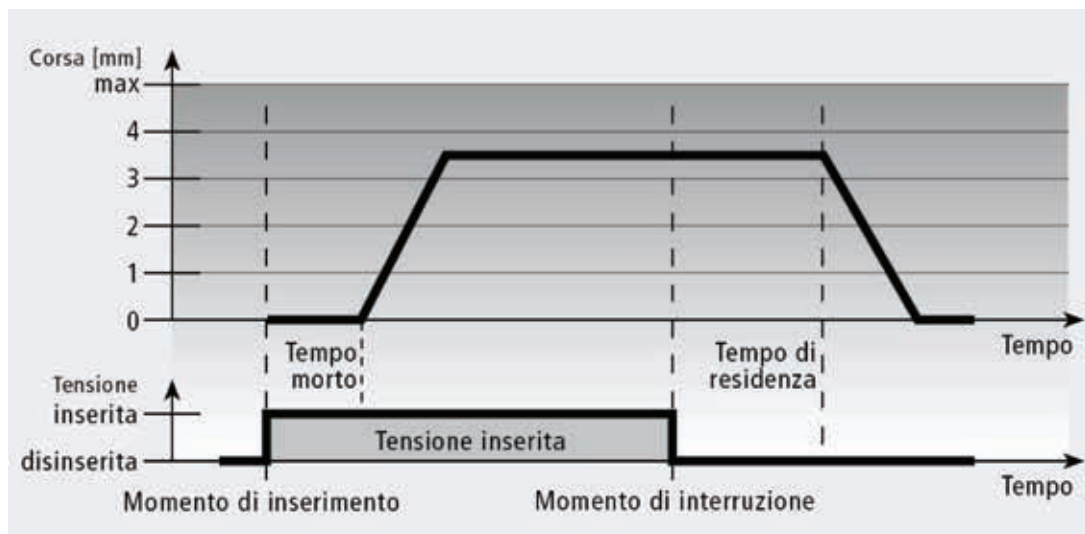

TE 3012 - TE 3013

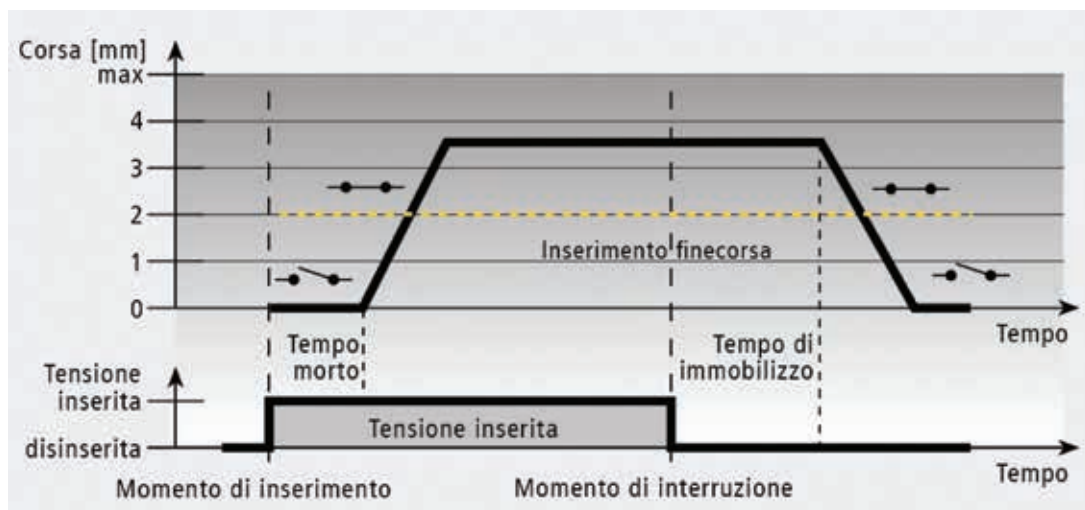

INSTALLATION INSTRUCTIONS: ASSEMBLY WITH VALVE ADAPTER

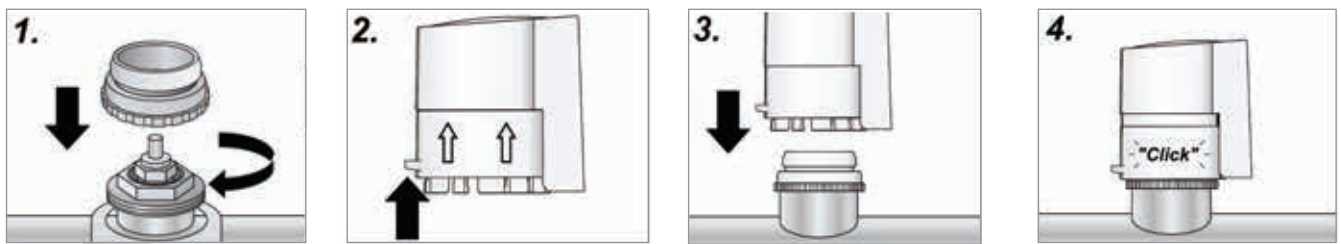

INSTALLATION INSTRUCTIONS FOR THERMOELECTRIC HEADS

- Screw the plastic adapter to the thermostatic screw (fig. 1);
- Push upwards the stop ring of the thermoelectric head (fig. 2);
- Place the head perpendicular to the valve (fig. 3);
- With a slight hand pressure, plug the head to the adapter: simply push until you hear a "click" (fig. 4).

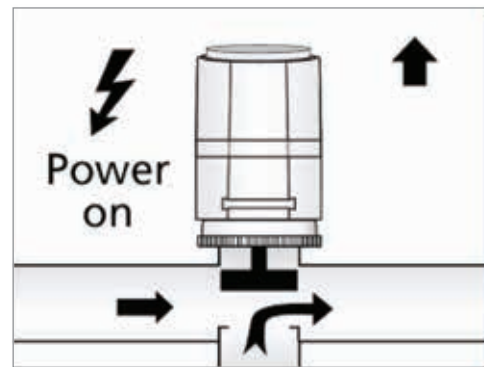
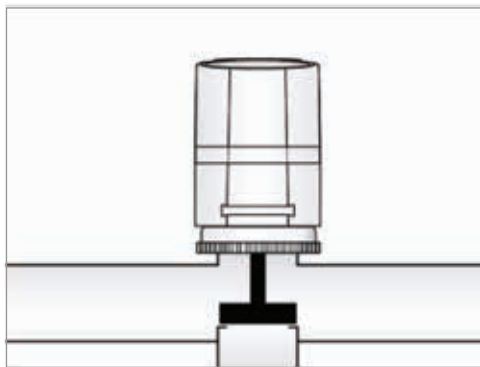

FUNCTION INDICATOR

The function indicator (round light blue diskette) allows to easily see (or feel, if in the dark) if the valve is open or closed. The indicator pops up when the valve opens.

START-UP OF THERMOELECTRIC HEADS

All thermoelectric heads are supplied in a locked, partially opened position (ca. 1/4). In order to unlock and start up, the head must be fed power for at least 6 minutes (for example from the thermostat in heating position). During this time, the head opens completely and breaks the block. After that, the head is ready to function.

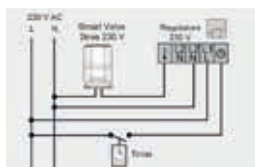

THERMOELECTRIC HEAD
ART. TE 3010
COD. 69011051

Thermolectric head 230V, normally closed, without limit switch.

Connections cables colours and corresponding function.

COLOUR	DESCRIPTION
brown	connecting head to voltage
blue	connecting head to neutral

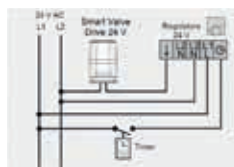

THERMOELECTRIC HEAD
ART. TE 3011
COD. 69011052

Thermolectric head 24V, normally closed, without limit switch.

Connections cables colours and corresponding function.

COLOUR	DESCRIPTION
brown	connecting head to voltage
blue	connecting head to neutral

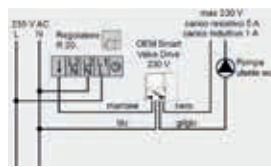

THERMOELECTRIC HEAD
ART. TE 3012
COD. 69011056

Thermolectric head 230V, normally closed, with limit switch.

Connections cables colours and corresponding function.

COLOUR	DESCRIPTION
brown	connecting head to voltage
blue	connecting head to neutral
black and grey	limit switch exit cable

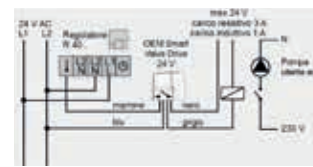

THERMOELECTRIC HEAD
ART. TE 3013
COD. 69011057

Thermolectric head 24V, normally closed, with limit switch.

Connections cables colours and corresponding function.

COLOUR	DESCRIPTION
brown	connecting head to voltage
blue	connecting head to neutral
black and grey	limit switch exit cable



CONNECTIONS

The thermostat and/or chrono-thermostat output to which the thermolectric heads must be connected are generally as shown in the following wiring diagrams:

Where:

C: Connection to power supply

N.C.: output normally closed for cable from the thermolectric head (do not use since our thermolectric head is normally closed).

N.A.: output normally open for the connection cable coming from the thermolectric head (the brown electric cable coming from the thermostatic head must be connected to this type of output).

APPLICATION EXAMPLE WITH CONNECTIONS:

- 1 chronothermostat
- 1 thermoelectric head

Each thermostat or chronothermostat can normally fit up to 10 thermoelectric heads in parallel. To know exactly the number of heads which can be connected, divide the thermostat output contact value N.A. by the head starting power.

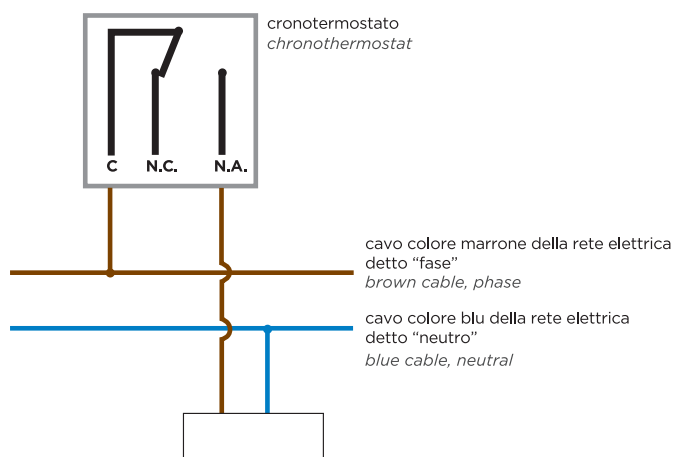

APPLICATION EXAMPLE WITH CONNECTIONS:

- 1 chronothermostat
- 3 thermoelectric heads with parallel connection

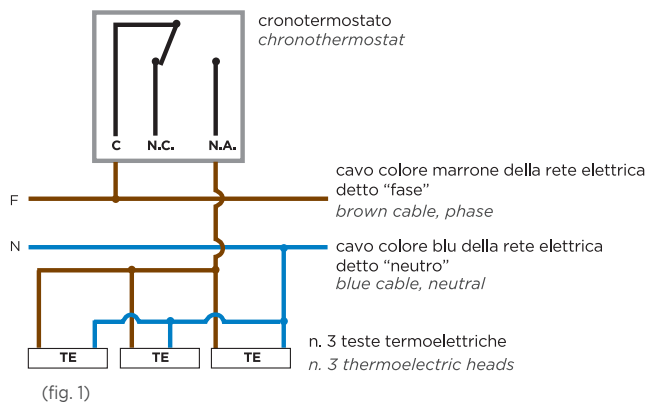

THERMOELECTRIC HEADS WITH AUXILIARY OR LIMIT SWITCH CONTACT

The limit switch contact is used to start the heating system pump when there is at least one thermoelectric head functioning, hence the pump cannot function when all the thermostatic valves are closed.

This device, stopping the pump when the system is not working, reduces wear on the pump and noise caused by the cavitation.

Teste termoelettriche con contatto di fine corsa art. TE 3012
Thermostatic head with limit switch art. TE 3012

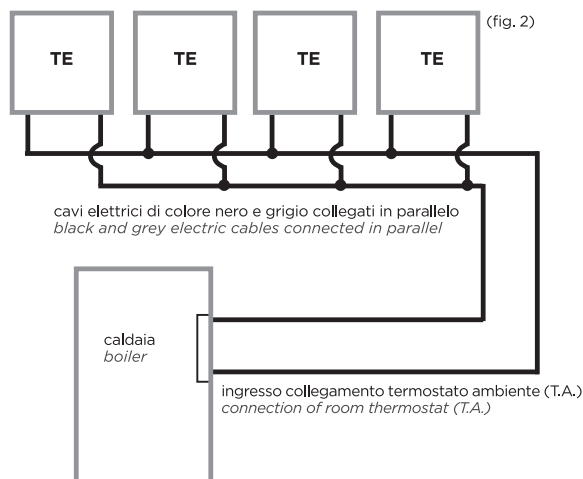

Teste termoelettriche con contatto di fine corsa art. TE 3012
Thermostatic head with limit switch art. TE 3012

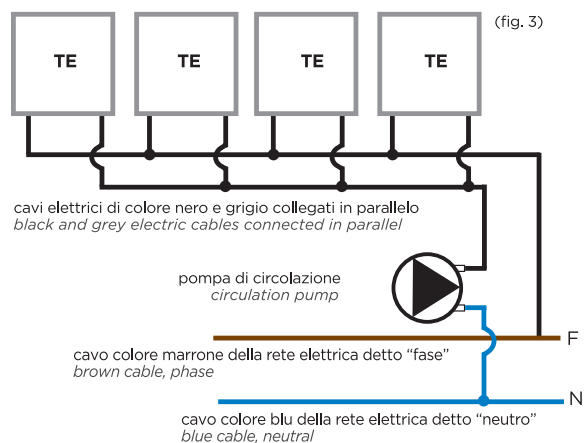

THERMOELECTRIC HEADS

**TE 3010**

Thermoelectric head 230 V (normally closed, opens with voltage)

- supply voltage 230 VAC
- supply cable 2 wires x 0,75 mm².

Length 1000 mm.

ARTICLE DISCONTINUED.

CODE	SIZE			
69011051	M30x1,5	100	1	100

**TE 3011**

Thermoelectric head 24 V (normally closed, opens with voltage)

- supply voltage 24 VAC
- supply cable 2 wires x 0,75 mm².

Length 1000 mm.

ARTICLE DISCONTINUED.

CODE	SIZE			
69011052	M30x1,5	100	1	100

**TE 3012**

Thermoelectric head 230 V with limit switch (normally closed-opens with voltage)

- supply voltage 230 VAC
- supply cable 4 wires x 0,75 mm².

Length 1000 mm.

ARTICLE DISCONTINUED.

CODE	SIZE			
69011056	M30x1,5	150	1	100



Limit switch

**TE 3013**

Thermoelectric head 24 V with limit switch (normally closed-opens with voltage)

- supply voltage 24 VAC
- supply cable 4 wires x 0,75 mm².

Length 1000 mm.

ARTICLE DISCONTINUED.

CODE	SIZE			
69011057	M30x1,5	150	1	100



Limit switch

**VA 3090S**

Replacement adapter for thermoelectric heads TE series.

ARTICLE DISCONTINUED.

CODE	SIZE			
69015024	M30x1,5	8	-	-

THERMOELECTRIC HEADS



TECHNICAL DATA

Thermoelectric heads function by exploiting the expansion of a thermosensitive element, which is heated up through an electrical resistor when the valve needs to be opened.

This allows for a slow open/close cycle and protects the system against water hammer.

Thermoelectric heads can only be connected to on/off thermostats or chronothermostats. Do not use 3-point or modulating thermostats or chronothermostats. TE thermoelectric heads are of the normally closed type, so they only open when

an opening input (voltage) comes from the control sensor (ex. thermostat).

This allow the head to work only when there is a need for hot or cold water to flow through the heating body, and to remain idle for the rest of the time.

The new thermoelectric heads can be installed in any position, even upside down, since they are secured against leakage from the thermostatic screws.

	TE 3110	TE 3111	TE 3112	TE 3113
supply voltage	230 V AC, +10%...-10%, 50/60 Hz	24 V AC/DC +20%...-10%, 0-60 Hz	230 V AC, +10%...-10%, 50/60 Hz	24 V AC/DC, +20%...-10%, 50/60 Hz
max input current	350 mA	200 mA	350 mA	200 mA
operating power	1 W	1 W	1 W	1 W
stroke	5 mm	5 mm	5 mm	5 mm
actuating force	100 N +10%	100 N +10%	100 N +10%	100 N +10%
micro-switch voltage	-	-	230 V AC: resistive load 5 A inductive load 1 A	24 V AC: resistive load 5 A inductive load 1 A 24 V DC: resistive load 3 A inductive load 1 A
micro-switch trigger point	-	-	2,6 ± 0,6 mm	2,6 ± 0,6 mm
liquid temperature	0÷100 °C	0÷100 °C	0÷100 °C	0÷100 °C
storage temperature	-25÷60 °C	-25÷60 °C	-25÷60 °C	-25÷60 °C
room temperature	0÷60 °C	0÷60 °C	0÷60 °C	0÷60 °C
protection degree	IP 54	IP 54	IP 54	IP 54
protection class	II	III	II	III
CE conformity	✓	✓	✓	✓
housing material	Polyamide			
housing colour	Grey			
connecting cable	2x0.75 mm ² PVC	2x0.75 mm ² PVC	4x0.75 mm ² PVC	4x0.75 mm ² PVC
cable colour	Grey			
cable lenght	1 m	1 m	1 m	1 m
weight	105 g	105 g	160 g	160 g
overvoltage resistance	2.5 kV	1 kV	2.5 kV	1 kV

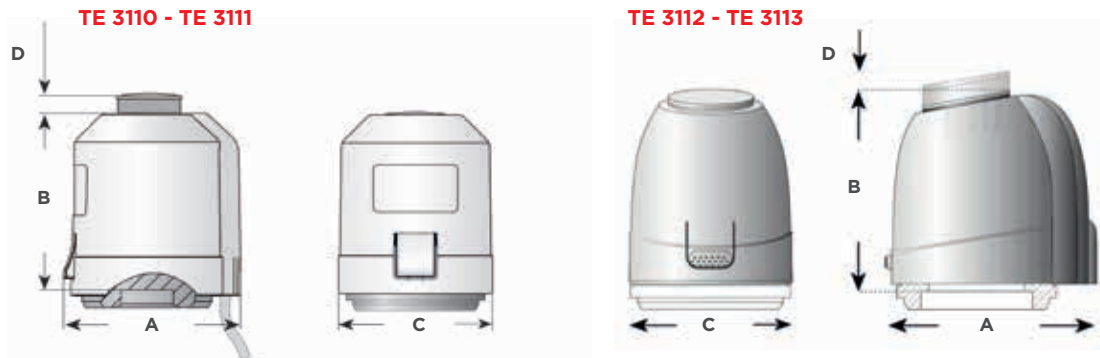

CODE	ARTICLE	SIZE	A	B	C	D	E	F	G	H
69011021	TE 3110	M30x1,5	50	54	44	5,5	-	M30x1,5	-	-
69011022	TE 3111		50	54	44	5,5	-		-	-
69011026	TE 3112		56	54	44	4	-		-	-
69011027	TE 3113		56	54	44	4	-		-	-

CHARACTERISTIC CURVES

TE 3110 - TE 3111

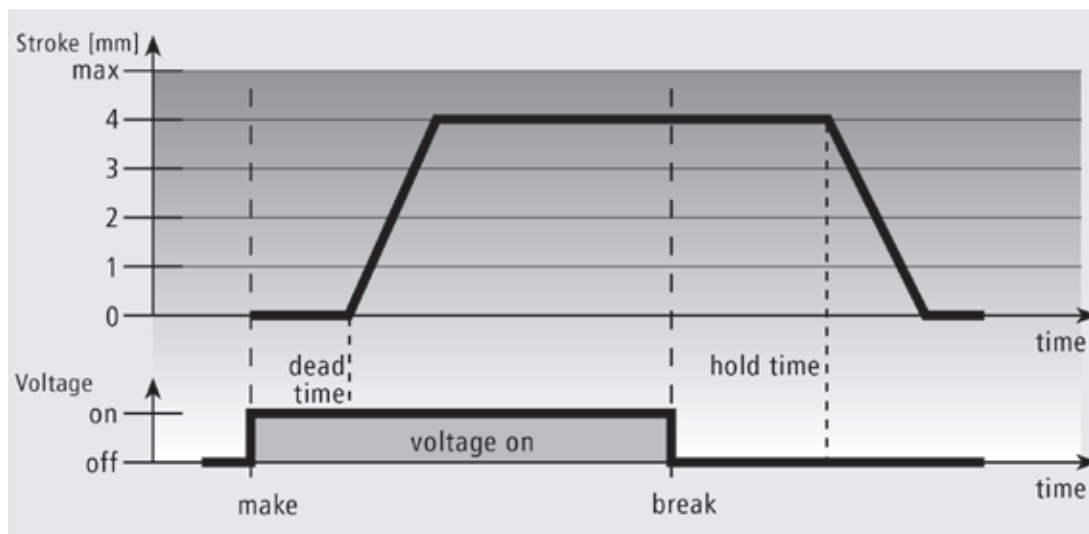

TE 3112 - TE 3113

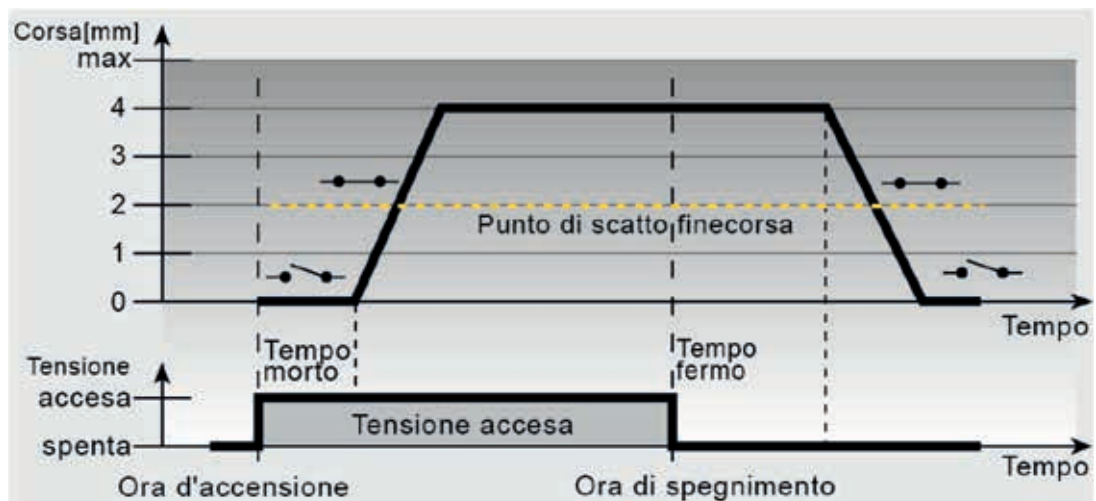

INSTALLATION INSTRUCTIONS: ASSEMBLY WITH VALVE ADAPTER

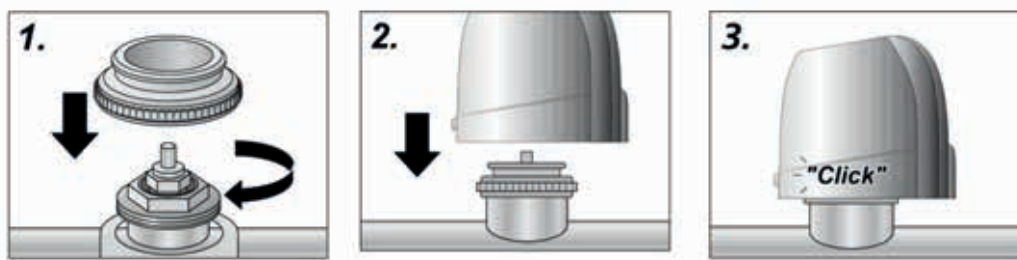

INSTALLATION INSTRUCTIONS FOR THERMOELECTRIC HEADS

- Screw the valve adapter manually onto the valve. (fig. 1);
- Position the actuator manually in vertical position to the

valve adapter. (fig. 2);

- Simply latch the actuator to the valve adapter manually by applying vertical pressure; a clicking sound can be heard. (fig. 3).

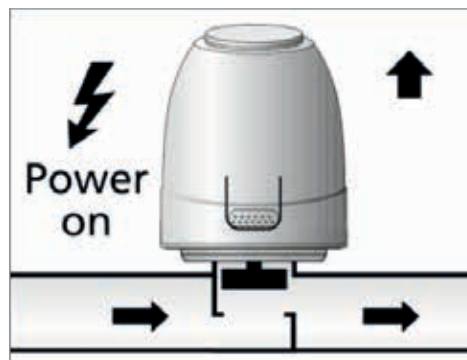
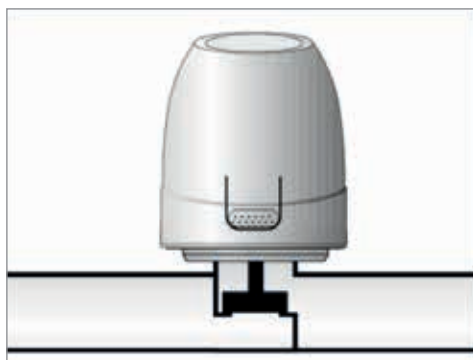

FUNCTION INDICATOR

The function indicator (round light blue or red diskette) allows to easily see (or feel, if in the dark) if the valve is open or closed. The indicator pops up when the valve opens.

START-UP OF THERMOELECTRIC HEADS

All thermoelectric heads are supplied in a locked, partially opened position (ca. 1/4). In order to unlock and start up, the head must be fed power for at least 6 minutes (for example from the thermostat in heating position). During this time, the head opens completely and breaks the block. After that, the head is ready to function.

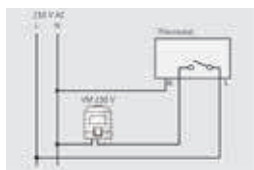

THERMOELECTRIC HEAD
ART. TE 3110
COD. 69011021

Thermoelectric head 230V, normally closed, without limit switch.

Connections cables colours and corresponding function.

COLOUR	DESCRIPTION
brown	connecting head to voltage
blue	connecting head to neutral

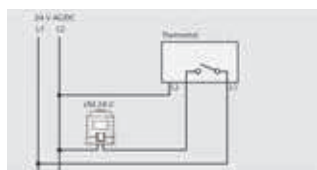

THERMOELECTRIC HEAD
ART. TE 3111
COD. 69011022

Thermoelectric head 24V, normally closed, without limit switch.

Connections cables colours and corresponding function.

COLOUR	DESCRIPTION
brown	connecting head to voltage
blue	connecting head to neutral

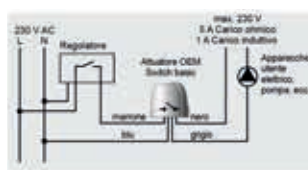

THERMOELECTRIC HEAD
ART. TE 3112
COD. 69011026

Thermoelectric head 230V, normally closed, with limit switch.

Connections cables colours and corresponding function.

COLOUR	DESCRIPTION
brown	connecting head to voltage
blue	connecting head to neutral
black and grey	limit switch exit cable

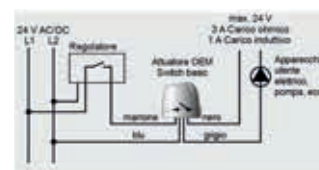

THERMOELECTRIC HEAD
ART. TE 3113
COD. 69011027

Thermoelectric head 24V, normally closed, with limit switch.

Connections cables colours and corresponding function.

COLOUR	DESCRIPTION
brown	connecting head to voltage
blue	connecting head to neutral
black and grey	limit switch exit cable



CONNECTIONS

The thermostat and/or chrono-thermostat output to which the thermoelectric heads must be connected are generally as shown in the following wiring diagrams:

Where:

C: Connection to power supply

N.C.: output normally closed for cable from the thermoelectric head (do not use since our thermoelectric head is normally closed).

N.A.: output normally open for the connection cable coming from the thermoelectric head (the brown electric cable coming from the thermostatic head must be connected to this type of output).

APPLICATION EXAMPLE WITH CONNECTIONS:

- 1 chronothermostat
- 1 thermoelectric head

Each thermostat or chronothermostat can normally fit up to 10 thermoelectric heads in parallel. To know exactly the number of heads which can be connected, divide the thermostat output contact value N.A. by the head starting power.

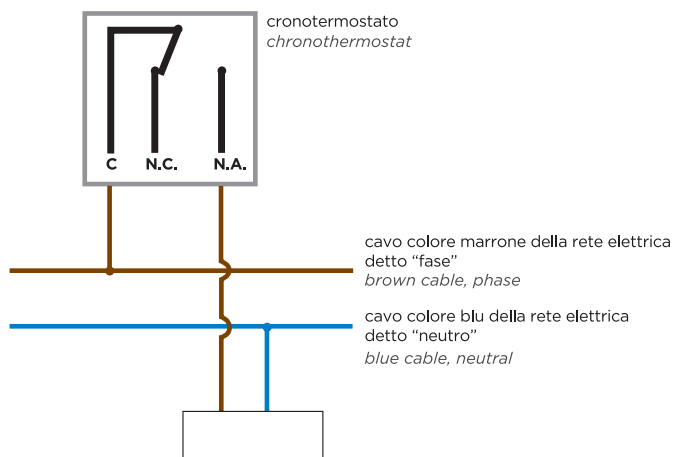

APPLICATION EXAMPLE WITH CONNECTIONS:

- 1 chronothermostat
- 3 thermoelectric heads with parallel connection

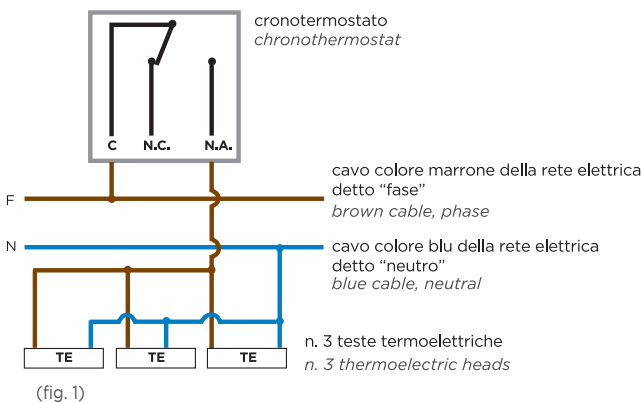

THERMOELECTRIC HEADS WITH AUXILIARY OR LIMIT SWITCH CONTACT

The limit switch contact is used to start the heating system pump when there is at least one thermoelectric head functioning, hence the pump cannot function when all the thermostatic valves are closed.

This device, stopping the pump when the system is not working, reduces wear on the pump and noise caused by the cavitation.

Teste termoelettriche con contatto di fine corsa art. TE 3112
Thermostatic head with limit switch art. TE 3112

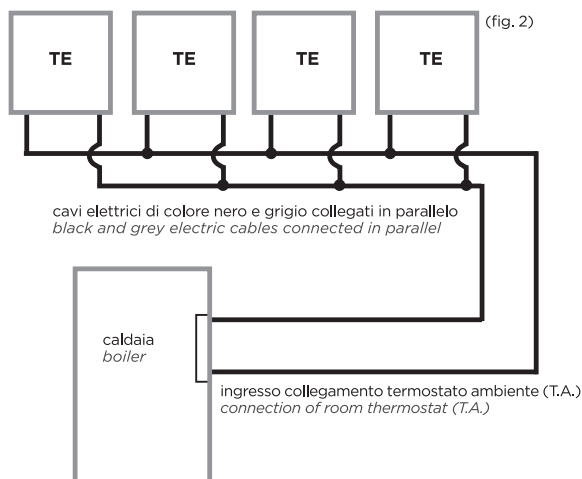

Teste termoelettriche con contatto di fine corsa art. TE 3112
Thermostatic head with limit switch art. TE 3112

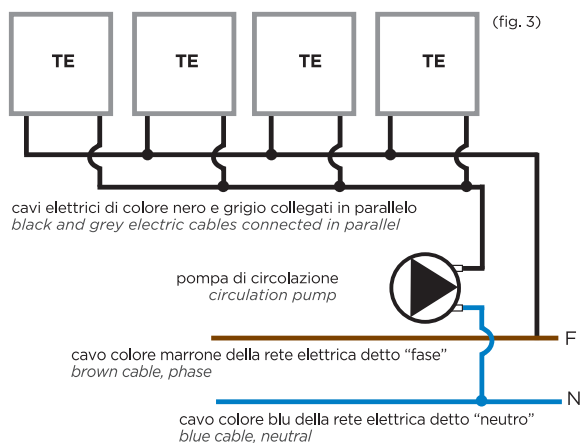

THERMOELECTRIC HEADS

TE 3110

Thermoelectric head 230 V (normally closed, opens with voltage)

- supply voltage 230 VAC
 - supply cable **2 wires** x 0,75 mm².
- Length 1000 mm.

CODE	SIZE			
69011021	M30x1,5	105	1	100

TE 3111

Thermoelectric head 24 V (normally closed, opens with voltage)

- supply voltage 24 VAC
 - supply cable **2 wires** x 0,75 mm².
- Length 1000 mm.

CODE	SIZE			
69011022	M30x1,5	105	1	100

TE 3112

Thermoelectric head 230 V with limit switch (normally closed-opens with voltage)

- supply voltage 230 VAC
 - supply cable **4 wires** x 0,75 mm².
- Length 1000 mm.

CODE	SIZE			
69011026	M30x1,5	160	1	100

**TE 3113**

Thermoelectric head 24 V with limit switch (normally closed-opens with voltage)

- supply voltage 24 VAC
 - supply cable **4 wires** x 0,75 mm².
- Length 1000 mm.

CODE	SIZE			
69011027	M30x1,5	160	1	100

**VA 3090**

Replacement adapter for thermoelectric heads TE series.

CODE	SIZE			
69015023	M30x1,5	8	-	-



CONTACT OR IMMERSION SAFETY THERMOSTATS

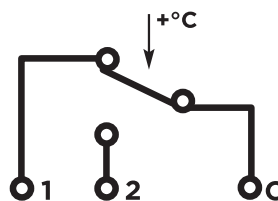

Collegamento elettrico
Electrical connection

TECHNICAL DATA

Contact Thermostat

Temperature regulation range: 0°C ÷ 90°C
 Temperature gradient: 1°C/min
 Minimum temperature tolerance ±4 °C
 Maximum temperature tolerance ±6 °C
 Differential temperature: 8 ±12 °C
 Nominal voltage on contacts:
 • 16 (4)A 250 V-
 • 6 (1)A 400 V-
 Nominal impulsive voltage 4kV
 Temperature limit of the control head: 85 °C
 Protection grade: IP 40
 Insulation class: I

Immersion thermostat

Temperature regulation range: 10°C ÷ 90°C
 Temperature gradient: 1°C/min
 Differential temperature: 6 ± 1°C
 Nominal voltage on contacts:
 • 15 (6)A / 250 V-
 Temperature limit of the control head: 85 °C
 Protection grade: IP 40
 Insulation class: I

CONSTRUCTIVE FEATURES

The purpose of safety thermostats is to maintain the water temperature in heating systems within set limits, and especially well under the critical point. Safety thermostats TS 3030, TS 3035, TS 3032, TS 3037 and TS 3050 are either contact or immersion thermostats.

These thermostats may function both as normally open and normally closed. The type of functioning is to be chosen during the electrical connection phase.

Electrical connection:

- Terminal C: phase
 - Terminal 1: opens the circuit when the temperature increases
 - Terminal 2: closes the circuit when the temperature increases
- Generally, in heating systems the electric appliance is connected to terminals C and 1 of the thermostat.

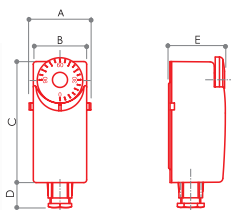

TS 3030

Contact safety thermostat, to be set as normally closed or open during installation.

CODE	SIZE	A	B	C	D	E	F	G	H	L			
69011230	-	45	38	88	18	42	-	-	-	-	132	1	10

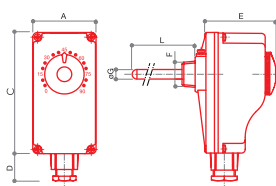



TS 3037

Safety thermostat with immersion probe, to be set as normally closed or open during installation.

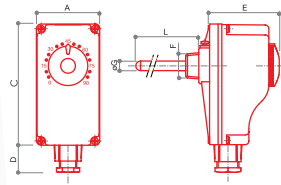
CODE	SIZE	A	B	C	D	E	F	G	H	L			
69011237	-	40	-	70	10	43	16	6,5	-	105	128	1	8

**TS 3035**

Safety thermostat with immersion probe, to be set as normally closed or open during installation.

CODE	SIZE	A	B	C	D	E	F	G	H	L			
69011235	G 1/2	40	-	70	10	43	16	6,5	-	105	128	1	8

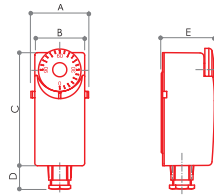

**TS 3032**

Contact safety thermostat pre-wired, normally closed.

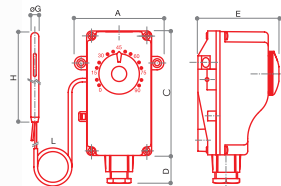
CODE	SIZE	A	B	C	D	E	F	G	H	L			
69011232	-	45	38	88	18	42	-	-	-	-	250	1	8



**TS 3050**

Safety thermostat with immersion probe, to be set as normally closed or open during installation.

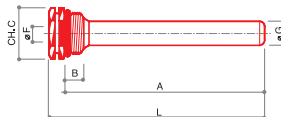
CODE	SIZE	A	B	C	D	E	F	G	H	L			
69011250	-	40	-	70	10	43	-	6,5	73	1000	132	1	8

**PS 541**

Yellow housing for probe TS 3050 and TS 3037.

CODE	SIZE	A	B	C	D	E	F	G	H	L			
9446952	G 1/2	100	10	22	-	-	7	12	-	108	84	20	160

CIRCULATION PUMP



TECHNICAL DATA

	PCEEI 752	PCE 756	PCE 757
EEL	≤ 0.20	< 0,23	< 0,23
liquid temperature	2 ÷ 95 °C	-10 ÷ 95 °C	-10 ÷ 90 °C
room temperature	0 ÷ 40 °C	0 ÷ 40 °C	0 ÷ 40 °C
max pressure	6 bar	6 bar	6 bar
max glycol quantity	40 %	20 %	20 %
connection threading	ISO 228 G 1"1/2	ISO 228 G 1"1/2	ISO 228 G 1"1/2
voltage supply	230 V (-10%; +6%)	230 V (-15%; 10%)	230 V (-15%; 10%)
frequency	50/60 HZ	50/60 HZ	50/60 HZ
protection	IP 44	IP 44	IP 44
insulation class	H	H	H

CHARACTERISTIC CURVES

PCEEI 752

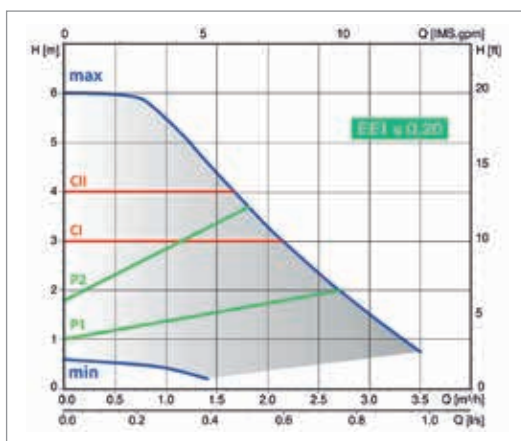

CI-CII constant curve
 P1-P2 proportional curve
 min-max n fixed curves

PCE 756

ΔP constant

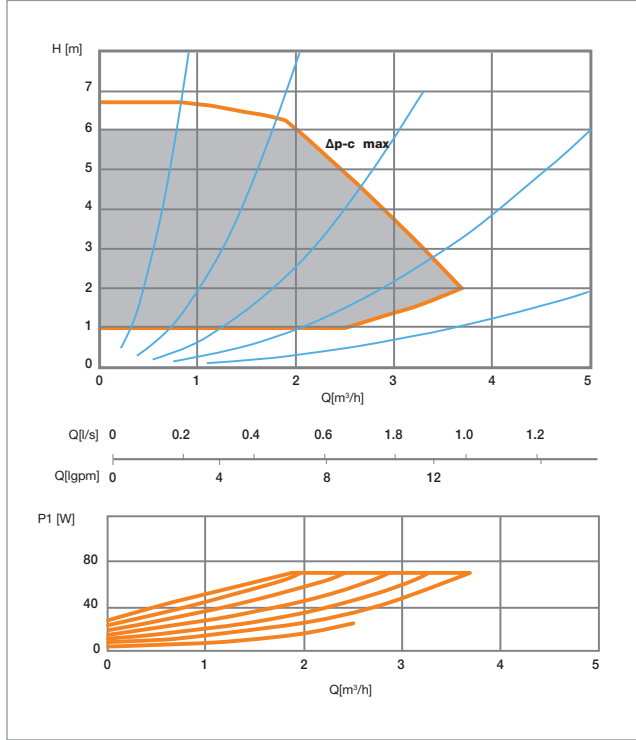

ΔP variable

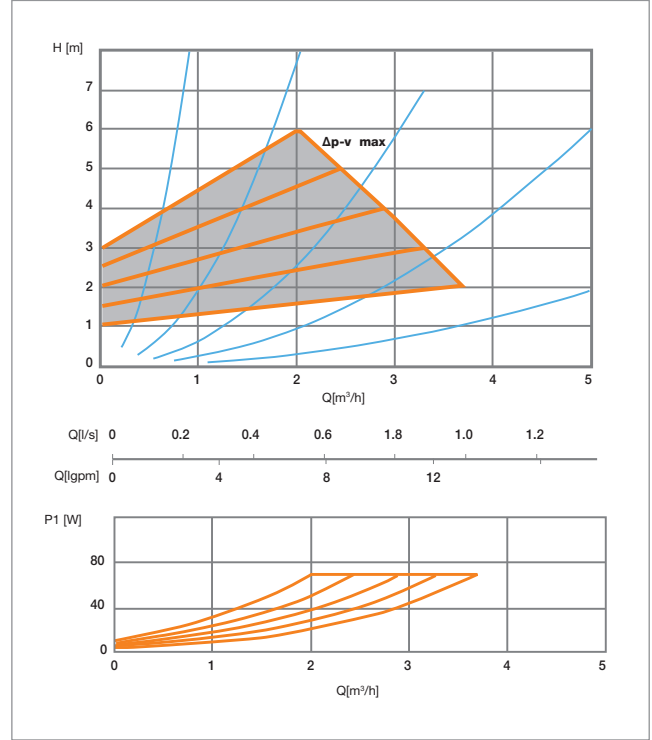

PCE 757

ΔP constant

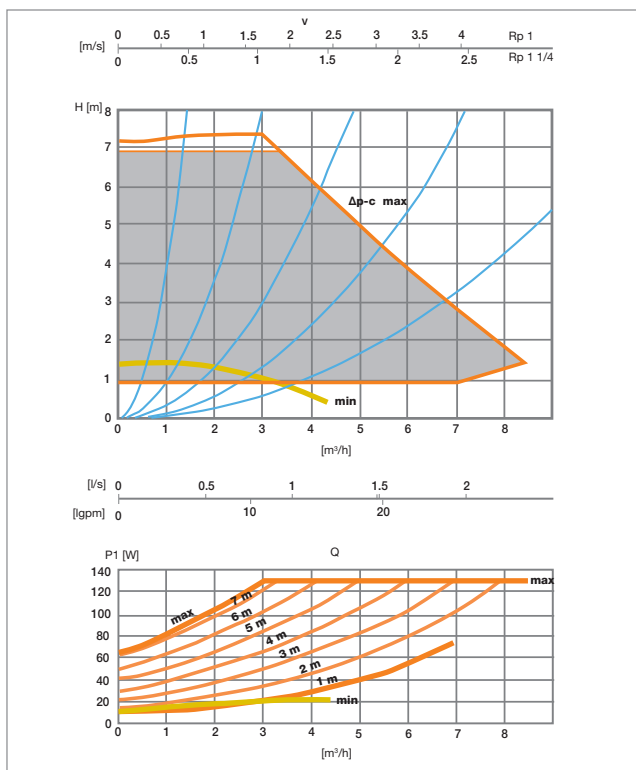

ΔP variable

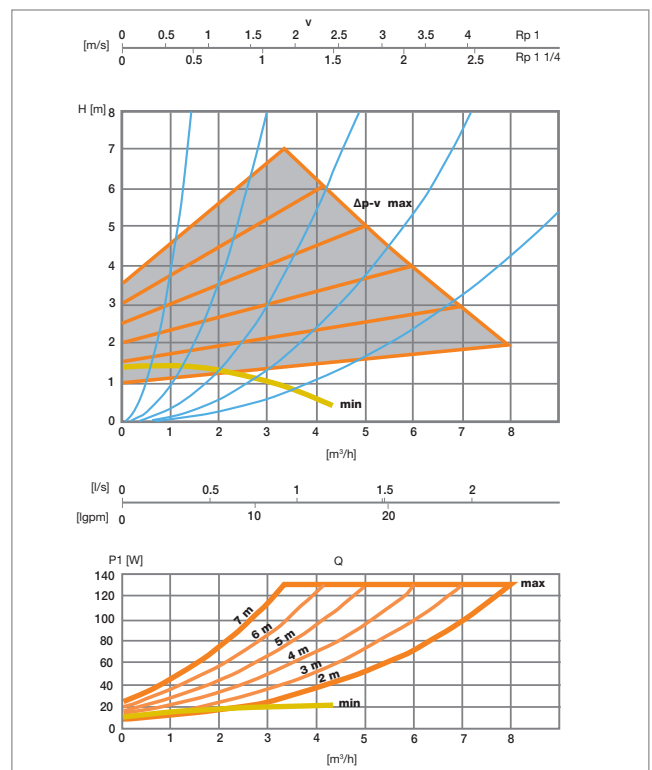

CIRCULATION PUMP

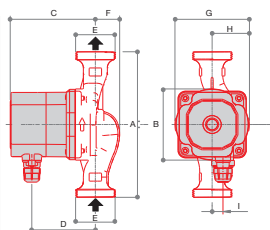

PCEEI 752

Electronic circulation pump with synchronous motor 25/60, interaxis 130 mm.

CODE	SIZE	A	B	C	D	E	F	G	H	I			
69011558	25/60-INT. 130 mm	130	88	104.5	78	G1"1/2	29.5	90	45	13.2	1810	1	-

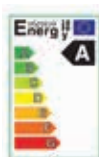

PCE 756

Electronic circulation pump with synchronous motor 25/70, interaxis 130 mm.

CODE	SIZE			
69011562	25/70-INT. 130 mm	2036	1	-

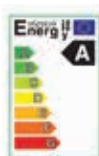

PCE 757

Electronic circulation pump with synchronous motor 25/80, interaxis 180 mm.

CODE	SIZE			
69011564	25/80-INT. 180 mm	3718	1	-



VP 5012

Ball valve for pumps with female connection G 1" and swivel nut G 1"1/2.

CODE	SIZE			
68559752	G 1"1/2 x G 1"	314	10	80



TZ 800

Galvanized nozzle for system testing, interaxis 130 mm.

CODE	SIZE			
7116601	G 1"1/2	676	3	24

INSTALLATION POSITION

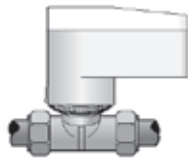

VERTICAL

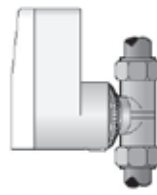

HORIZONTAL

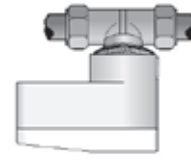

“UPSIDE DOWN”

The servomotor can be used at any installation location. The preferred installation locations to be used, where possible, are horizontal or vertical.

The “upside down” installation, in particular circumstances (e.g. wastewater), can reduce the service life of the servomotor.

OPERATING DIAGRAMS

SM 1346

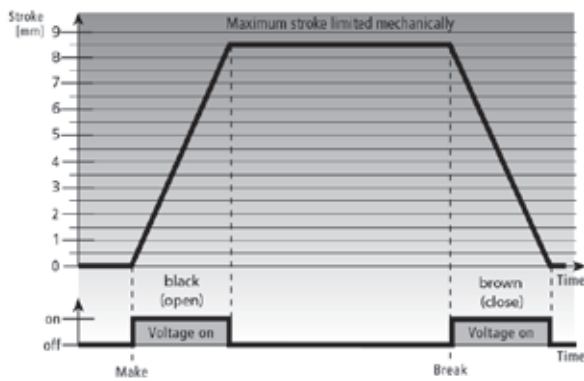

SM 1348

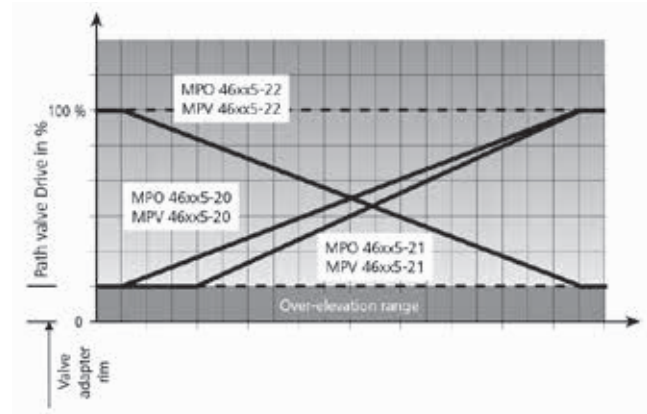

ELECTRICAL CONNECTIONS

SM 1346

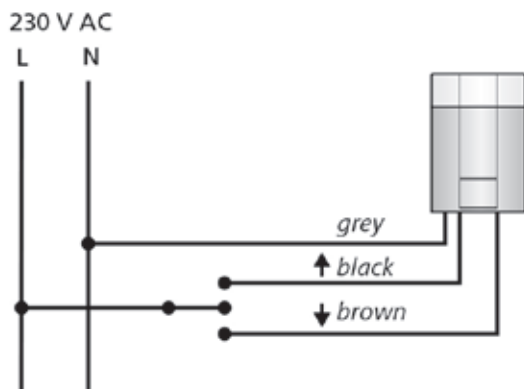

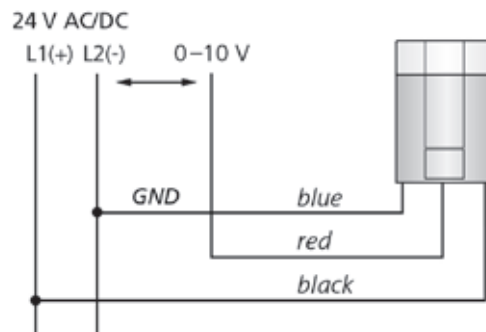

SM 1348

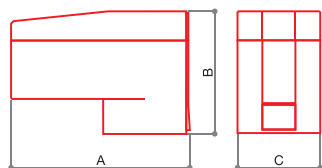

SERVOMOTORS



**SM 1346**

3-point servomotor, 230 V,
connection M30x1,5.

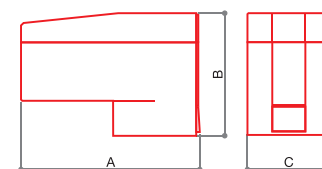
CODE	SIZE	A	B	C	D	E	F	G	H	L			
69011717	230 V	90	65	44	-	-	-	-	-	-	208	1	-

**SM 1348**

Modulating actuator, 24V, connection
M30x1,5.

CODE	SIZE	A	B	C	D	E	F	G	H	L			
69011719	24 V 0-10V	90	65	44	-	-	-	-	-	-	163	1	-

ACTUATOR FOR ROOM TEMPERATURE CONTROL



Those who install heating, ventilation and cooling systems ask for economical but state-of-the-art technologies to guarantee the safety of the systems they develop.

Luxor's actuator TE 3020, with Direct Digital Control for operating voltages from 0 to 10 Volt, offers the following advantageous features:

- **modulating**: continuous and permanent adjustment with 0-10 V actuation;
- **automatic calibration**: self-regulation with zero-point detection and tolerance compensation;
- **easy maintenance**: function indicator;
- **silent**: thermoelectric principle;
- **long-life performance**: wear-resistant, no need for maintenance, operating safety guaranteed;
- **economical**: excellent price-performance ratio.

TECHNICAL DATA

Type: normally closed
 Supply voltage: 24V AC, -10%...+20%, 50-60 Hz
 Max inrush current: <math>< 320 \text{ mA}</math> during 2 min. max.
 Operating power: 1 W
 Working voltage: 0-10 V DC
 Input resistance: 100 k Ω
 Work stroke: 4 mm (minus 0.5 mm over-elevation)
 Pushing force: 100 N +5%
 Liquid temperature: 0÷100 °C
 Storage temperature: -25÷60 °C
 Room temperature: 0÷60 °C
 Degree of protection: IP 54
 Protection class: III
 CE conformity according to EN 60730: EN 60730
 Material: White polyamide
 Power cables: 3x0.22 mm² PVC
 Power cable length: 1 m

CHARACTERISTIC CURVES

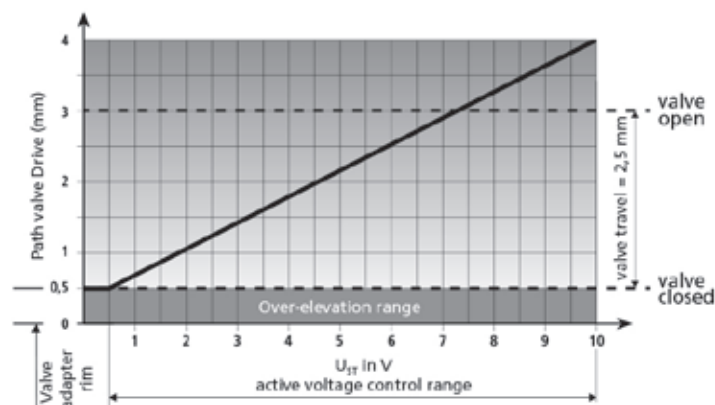

OPERATING INSTRUCTIONS

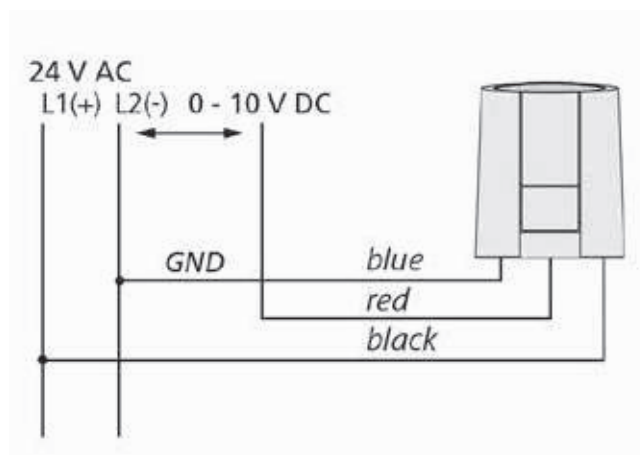

When assembled on control valves, the actuator TE 3020 performs several switch-on and adjustment activities as a modulating (continuous) regulating element. The 0-10 V actuation is proportionally transformed into a 0-4 mm stroke. The electrical heating up of the wax element is controlled by the built-in electronics.

According to the operating voltage applied, the valve silently opens thanks to the lifting of the wax element. The actuator TE 3020 reaches its maximum stroke with operating voltages above 10 V.

INSTALLATION WITH ADAPTER



1. Manually screw the valve adapter onto the valve.



2. Connect the power cable to the actuator.



3. Manually position the actuator vertically on the valve adapter.



4. Attach the actuator to the valve adapter by manually applying the vertical pressure until you hear a click.

The TE 3020 actuators are equipped with the "first open" operation, that is, the actuator at the time of delivery is in the normally open state. This allows the system to be washed and filled with already assembled heads, even before the electrical wiring. In the following commissioning, the application of operating voltage (for more than 6 minutes) causes the automatic triggering of the "first open" operation and the actuator is thus ready for operation.

INSTALLATION POSITION



VERTICAL



HORIZONTAL



"UPSIDE DOWN"

The actuator can be installed in any position, however the recommended positions are vertical and horizontal.

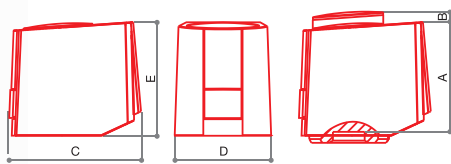

The "upside down" position in some circumstances, e.g. dripping, could reduce the life of the device.

ACTUATOR FOR ROOM TEMPERATURE CONTROL



TE 3020

Actuator for room temperature control.
Thermoelectric head 0-10 Volt.

CODE	SIZE	A	B	C	D	E	F	G	H	L			
69011420	M30x1,5	51.1	7	61.5	44.3	53	-	-	-	-	150	1	-



LUXOR®

6 / MODULAR HYDRONIC SYSTEM

MODULAR HYDRONIC SYSTEM



The modular hydronic system consists of:

- a modular distribution manifold;
- pumping groups;
- fixed-points mixing and pumping groups;
- mixing and pumping groups with sliding temperature.

The modular hydronic system SIM 1208 is used in the distribution and operation of zone systems. It was developed to create several solutions aimed at simplifying and solving various installation issues. All components in contact with water are in brass or stainless steel and the gaskets in peroxide cured EPDM. The use of these metals prevents the bimetallic corrosion occurring with metals of different nobility.

The manifold can be connected to the boiler from any direction. In this way, it is possible to connect one or more energy sources at the same time, such as a boiler and a refrigeration group. The whole system can easily be assembled on site. The manifold is modular, so it can be composed with a number of elements according to the system requirements. Each module of the manifold can be assembled so as to have the connections to the groups both on the left or the right, thus being adaptable to the existing system.

Thermomanometers, air vent valves, water inlet/outlet valves, expansion vessels and safety groups can be installed on the free connections of the manifold.

Each pumping group can be installed either with left or right connections. Each mixing and pumping group is provided with thermometers to read the inlet and outlet temperature, a differential bypass valve for the pump installed on the groups and seats for regulation and reading probes. The mixing groups can be connected directly to the boiler (without manifold) and act as a pumping and mixing unit.

Mixing groups feature a 3-way piston mixing valve for fixed-point or sliding adjustment. The mixing valve is also equipped with two bypasses, one before and one after the mixing. Mixing groups are provided with a safety thermostat with immersion probe and housing.

The SIM 1208 can be installed in a metal cabinet and, if needed, hung to the wall through its brackets. All versions of the SIM 1208 are extremely compact.

It allows to install up to 5 G 1 1/4 groups in 700 mm of width, and up to 6 if the boiler is connected on one side. With the pumps placed horizontally, the depth of the system is only 100 mm.

TECHNICAL DATA

Maximum working pressure 6 bar
 Maximum working temperature 80 °C
 Mixing Kvs value 5,5 (recirculation) – 6.9 (primary exchange)

CONSTRUCTIVE FEATURES

Manifold

Brass manifold, material:
 CB 753 S UNI EN 1982-2000 for faucets
 Connection kit for modules, material:
 CW614N UNI EN 12164:2016
 Gasket, material:
 Peroxide cured EPDM

Mixing unit

Flow meter, material:
 Brass CB 753 S UNI EN 1982- 2000 for faucets
 Gasket, material:
 Peroxide cured EPDM
 Brass parts of the screw, material:
 CW614N UNI EN 12164:2016
 Steel parts of the screw, material:
 Stainless steel

Probe holder group

Brass manifold, material:
 CB 753 S UNI EN 1982-2000 for faucets
 Components material:
 CW614N UNI EN 12164:2016
 Max recommended flow to mixing valve 2.750 l/h
 (Δp 0.25bar)
 Thermometer range 0÷ 80 ° C

Thermometers

Thermometer case and stem in galvanized steel
 Covering in transparent plastic material
 Thermometric element bimetallic spring

Pumps

Wilo Yonos Para RS 25/6-130-FSM-RKA-12
 Wilo Stratos Para 25/1-7-130 T3
 Wilo Stratos Para 25/1-8-130 T3

GALVANIC TREATMENTS

Nickel plating

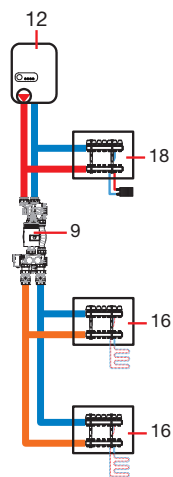
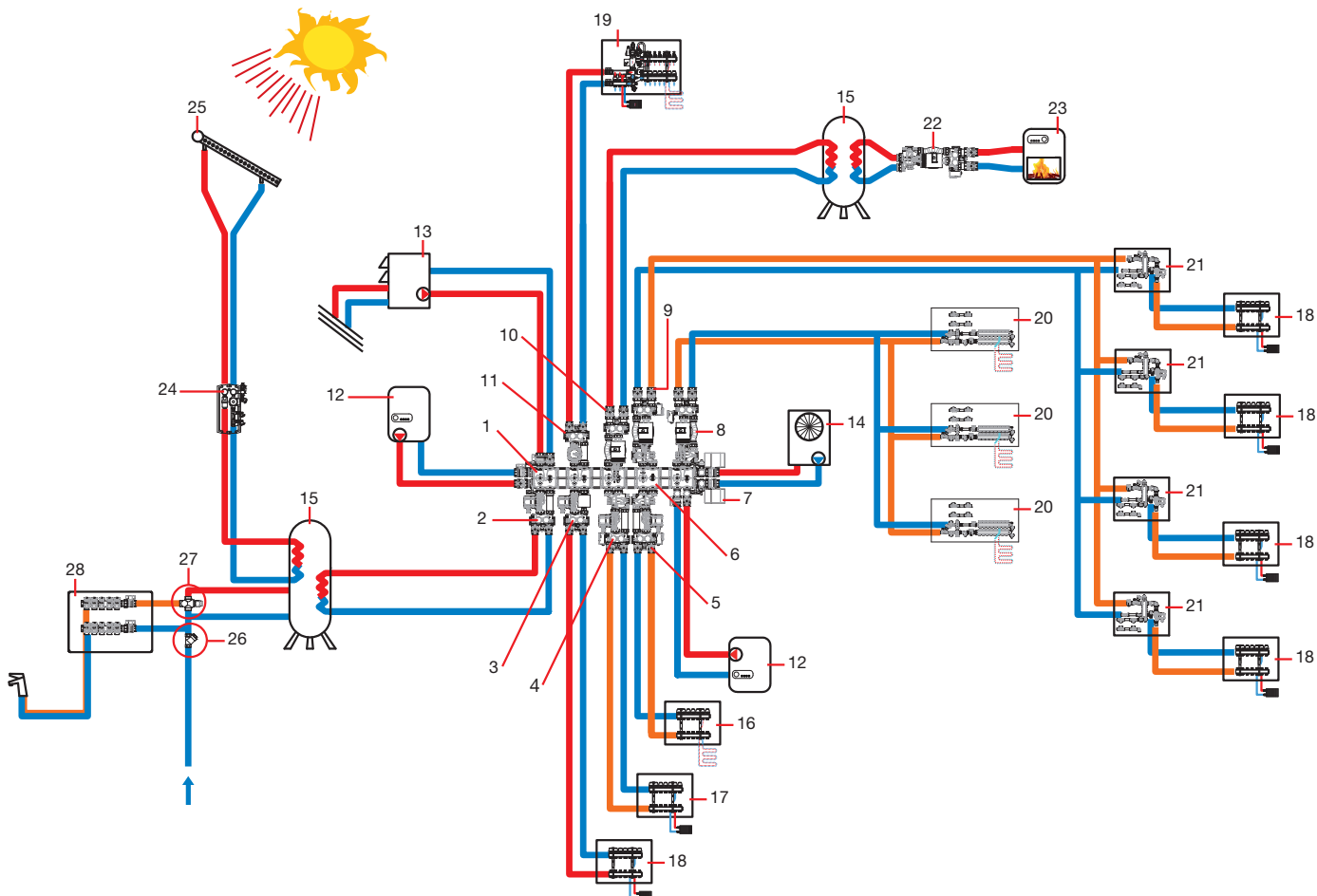

- 1 Manifold CD 1210
- 2 Pumping unit G 1" GR 112-GR 1230
- 3 Pumping unit G 1" GR 1220 - GR1230 with heat meter G 3/4 interaxis 110 mm
- 4 Mixing group G1" with left inlet GM 1260 - GM1270
- 5 Mixing group G1" with right inlet GM 1260 - GM1270
- 6 Manifold CD 1210 assembled backhand to invert the connection of the pumping/mixing unit (right inlet)
- 7 Zone Valve VZ 700
- 8 Mixing group G 1" 1/4 installed with right inlet GM 1260 - GM 1270
- 9 Mixing group G 1" 1/4 installed with left inlet GM 1260 - GM 1270
- 10 Pumping unit G 1 1/4 GR 1220 - GR 1230
- 11 Pumping unit G 1" GR 1220 - GR 1230
- 12 Boiler
- 13 Heat pump
- 14 Refrigeration group
- 15 Heater
- 16 Manifold CD 2468 for distribution in radiant panels system
- 17 Manifold CD 2468 for distribution in Fan coil system
- 18 Manifold CD 2468 for distribution in Fan coil system
- 19 Complete pre-assembled distribution group for high temperature, fixed-point mixing and pumping
- 20 Pre-assembled group MC 5001 designed for heat and sanitary water metering, deviation valve and distribution manifolds.
- 21 Pre-assembled group MC 5003 designed for heat and sanitary water metering, hydraulic separator and pump
- 22 Mixing group G 1" 1/4 with fixed point for recirculation in solid fuel boilers
- 23 Solid fuel boiler
- 24 Circulation group for solar panels GSP 1180
- 25 Solar panel
- 26 Filter RF 5008
- 27 Sanitary mixing valve VM 660
- 28 Sanitary manifolds

DIMENSIONAL DRAWING

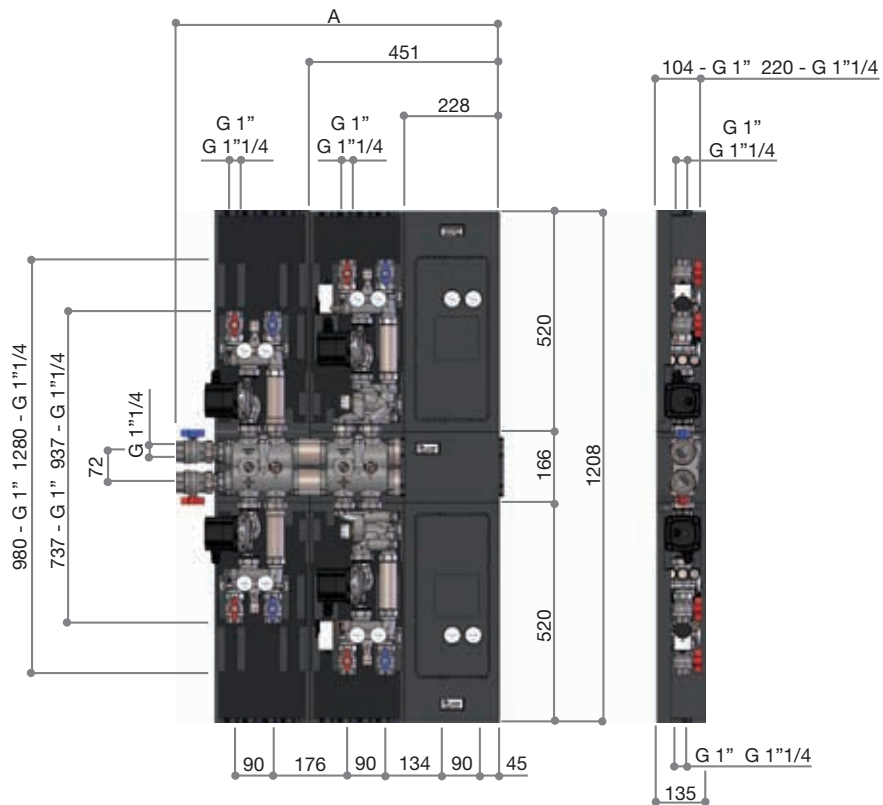
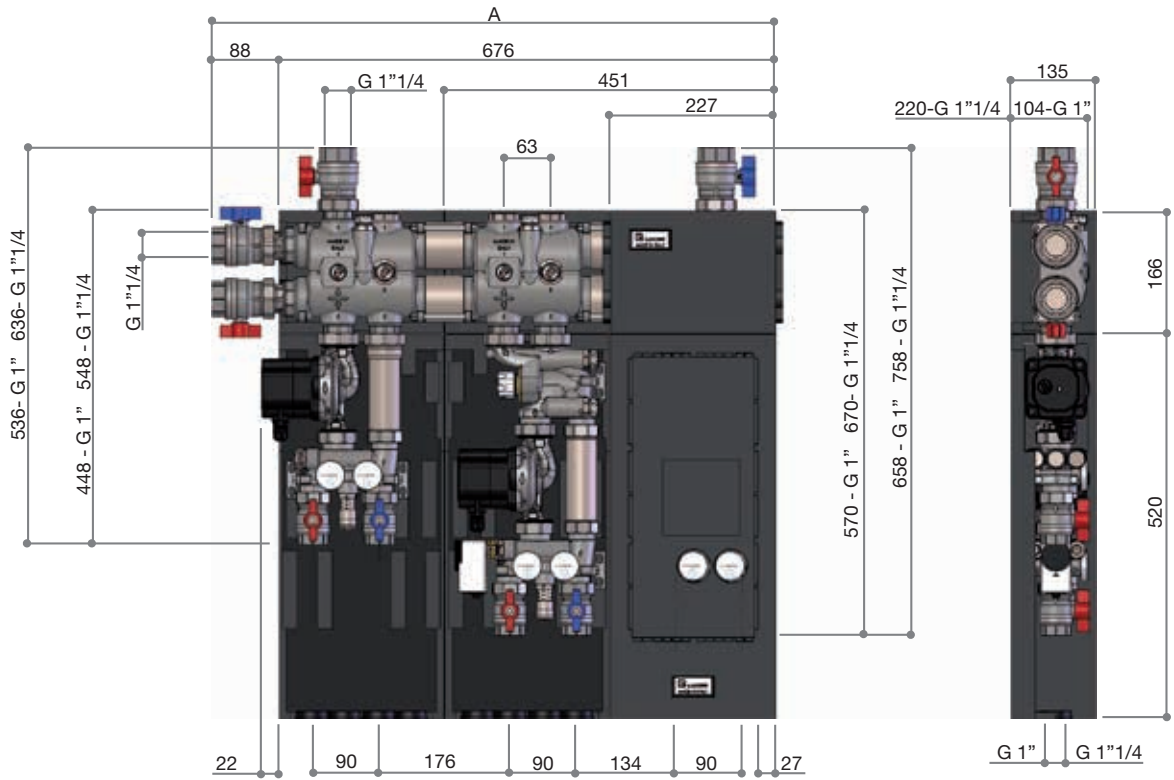

MANIFOLDS

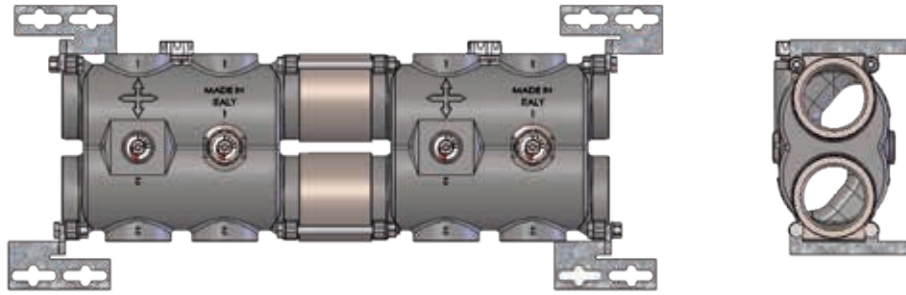

Modular manifold G 1"1/2, with connection for groups G 1"1/4 and balancing and by-pass valves
It can also act as a hydraulic separator by opening the by-pass installed on all modules.

Free inner passage \varnothing 45mm.
Connection to primary circuit G 1"1/2.
Connection to pumping and mixing groups G 1"1/4.

FLOW SCHEME

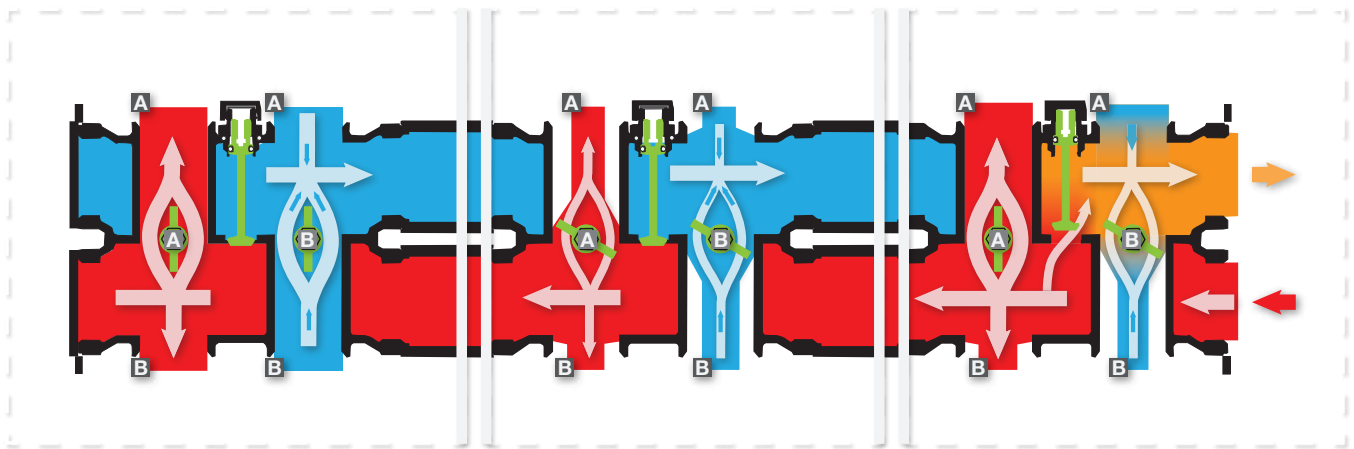

Manifold module with:
A. Balancing valve all open
B. Balancing valve all open

Manifold module with:
A. Balancing valve partially open
B. Balancing valve partially open

Manifold module with:
A. Balancing valve all open
B. Balancing valve partially open

HYDRAULIC CHARACTERISTICS OF MANIFOLD CD 1210

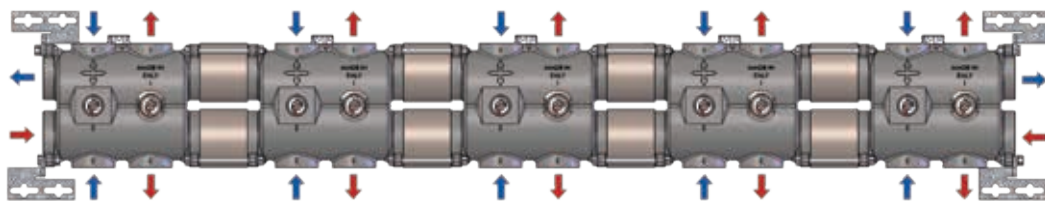

When the manifold CD 1210 is assembled in one direction only with the connections alternating on both sides of the manifold and main connection G 1"1/2, it works like a coplanar manifold.
If necessary, it can be assembled so as to reverse the outlets. In the following picture the third and fourth module are inverted.

The outlets can be reversed by rotating the module of the manifold of 180°. The head inlets on the manifold and all the modules will remain unchanged. This is very convenient when it is necessary to adjust the manifold connections to the existing installations.

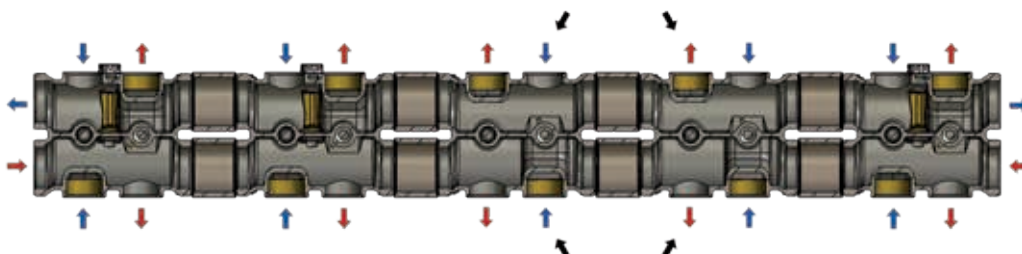

MANIFOLDS FLOW RATE CHART

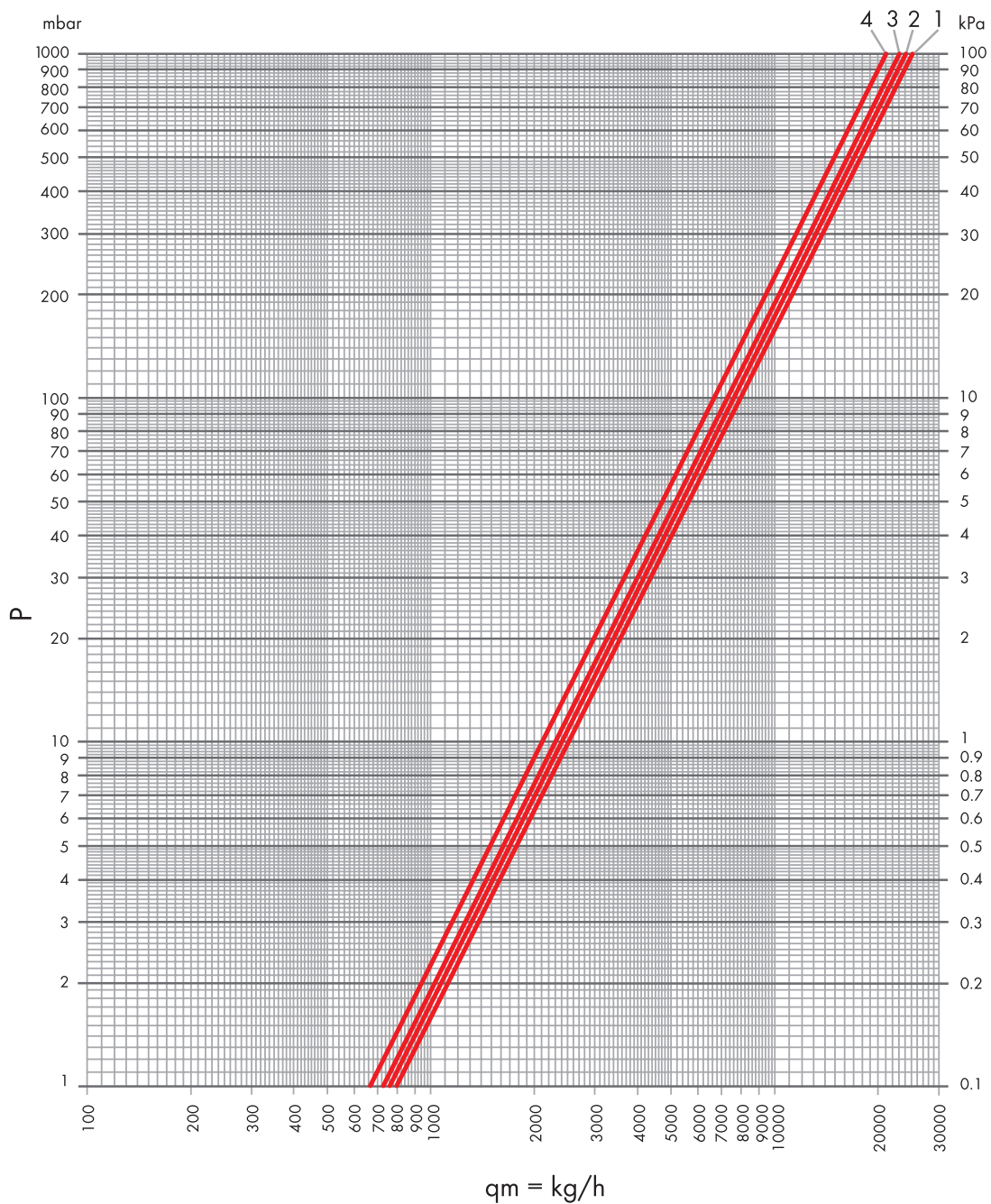

Kvs	OUTLETS N°	POS
25	2	1
24	3	2
23	4	3
21	5	4

BALANCING VALVE AND BYPASS KV CHART

BYPASS

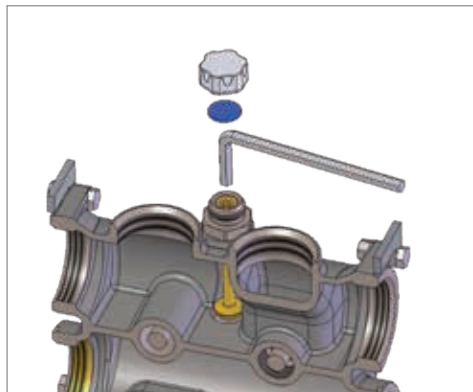

CLOSURE TURNS	Kv
1/4	0,17
1/2	0,51
1	1,27
1"1/2	1,87
2	2,55
2"1/2	3,05

CLOSURE TURNS	Kv
3	3,56
3"1/2	3,82
4	3,99
4"1/2	4,16
All open	4,33

The manifold can function as a hydraulic separator opening the bypass of each module.

It is a useful solution when there is more than one heat generator and/or primary circuit.

BALANCING VALVE

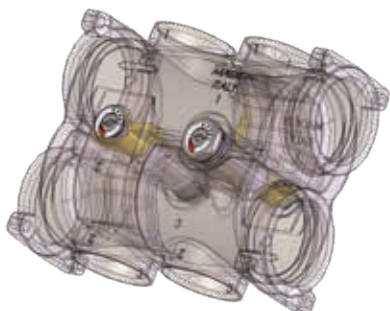

STEM INDEX POSITION	Kv
0	5,43
1	6,79
3	8,13
5	8,51
7	8,72

The regulation of the balancing valve is very handy (and in some cases essential) when a manifold supplies several groups.

The groups are all connected in parallel, when a group is disadvantaged, the balancing valves can correct the situation by balancing the circuits so as to assure the correct functioning of the system.

PLEASE NOTE

Each manifold module has two balancing valves. The regulation of the valves can be made on both sides of the manifold.

Each valve regulates the Kv of a couple of connection G 1"1/4. The corresponding valves and connection are identified by the numbers "1" and "2".

MODULAR MANIFOLD DIMENSIONAL DRAWING

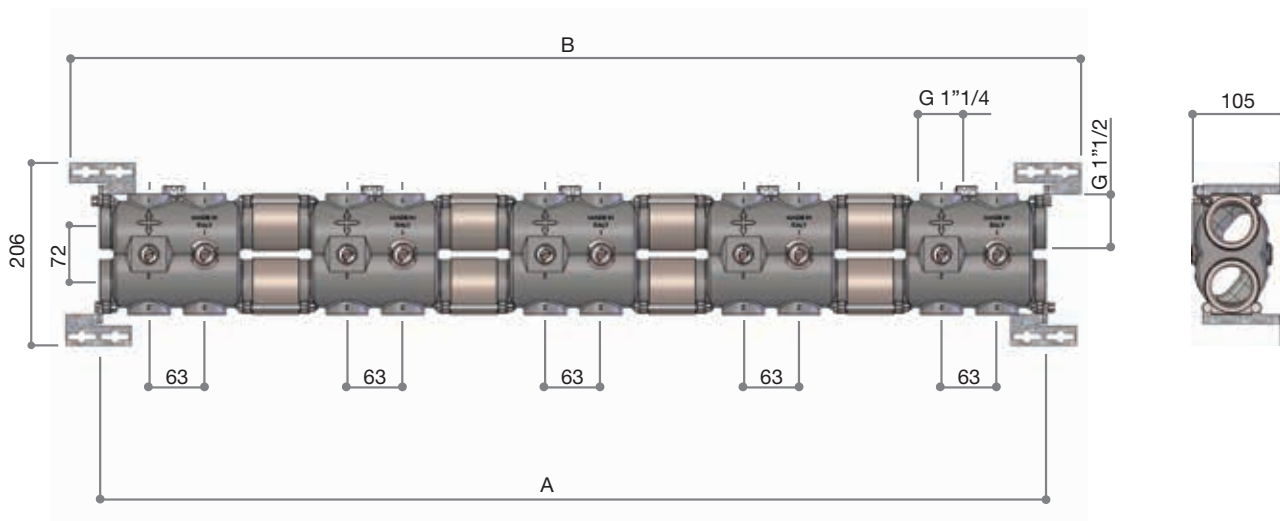

CD 1210

CODE	CONNECTIONS	A	B	C	D	E	F	G	H	L	M	N	P	R
68744251	1+1	174	267	-	-	-	-	-	-	-	-	-	-	-
68744252	2+2	398	471	-	-	-	-	-	-	-	-	-	-	-
68744253	3+3	622	695	-	-	-	-	-	-	-	-	-	-	-
68744254	4+4	846	919	-	-	-	-	-	-	-	-	-	-	-
68744255	5+5	1070	1143	-	-	-	-	-	-	-	-	-	-	-



CD 1210

Modular distribution manifold G 1 1/2 with connection for groups G 1 1/4 and bypass, balancing valves. The bypass valves installed on all the modules can be opened and function as a hydraulic separator. Internal free passage ø 45mm. (the CB version is insulated).

CODE	CONNECTIONS	SIZE	Ⓚg	📦	📦
68744251	1+1	G 1 1/2 x G 1 1/4	3,884	1	-
68744251CB	1+1		3,964	1	-
68744252	2+2		8,226	1	-
68744252CB	2+2		8,386	1	-
68744253	3+3		12,568	1	-
68744253CB	3+3		12,808	1	-
68744254	4+4		16,910	1	-
68744254CB	4+4		17,230	1	-
68744255	5+5		21,252	1	-
68744255CB	5+5		21,652	1	-

PUMPING GROUPS

DIMENSIONAL DRAWING

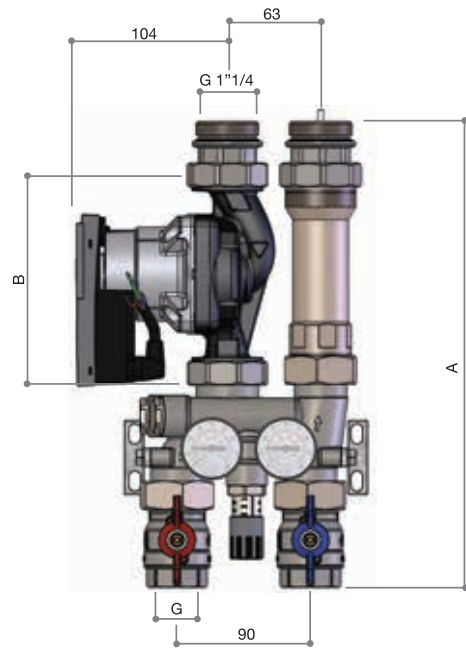
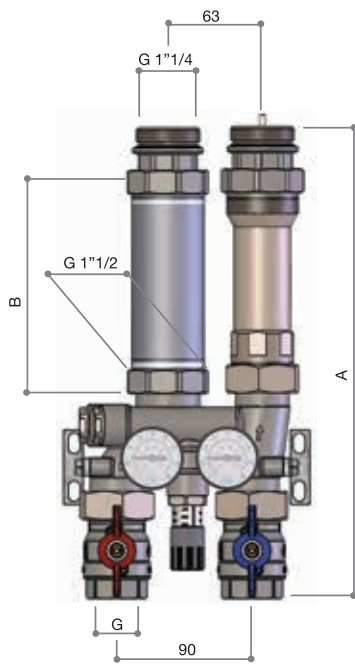

GR 1220

CODE	SIZE	A	B	C	D	E	F	G
68763400	G 1"	315	130	-	-	-	-	G 1"
68764200	G 1 1/4"	415	180	-	-	-	-	G 1 1/4"

GR 1230

CODE	SIZE	A	B	C	D	E	F	G
68763410	G 1"	315	130	-	-	-	-	G 1"
68764210	G 1 1/4"	415	180	-	-	-	-	G 1 1/4"

HYDRAULIC SCHEME

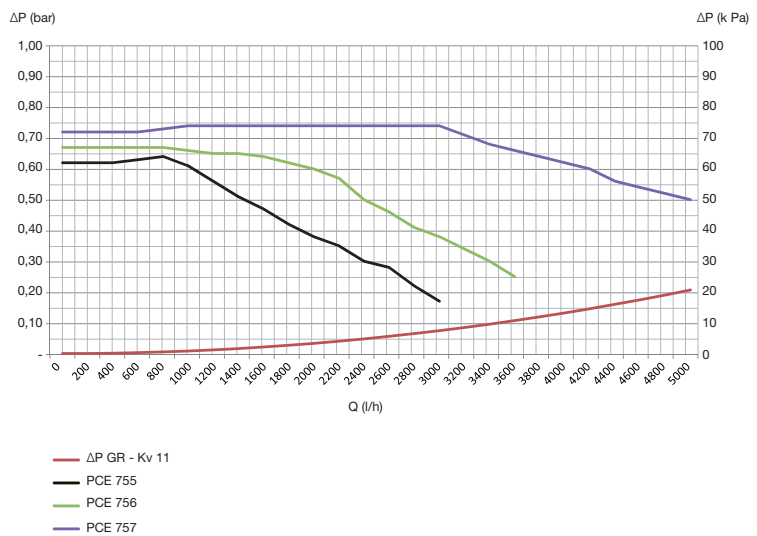
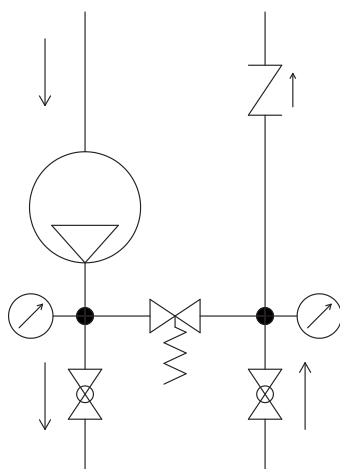

To avoid excessive noise in the system, do not use with ΔP value higher than 0,2-0,25 bar.

PUMPING GROUPS



GR 1220

Pumping group without pump.
Maximum recommended flow rate
3.000 l/h.

Each group is equipped with:

- thermometers to display the delivery and return temperature;
- differential bypass valve;
- check valve;
- shut-off valves for circuits.
(the CB version is insulated).

CODE	SIZE	INTERAXIS			
68763400	G 1"	130 mm	4,474	1	-
68763400CB	G 1"	130 mm	4,754	1	-
68764201	G 1"	180 mm	4,922	1	-
68764200	G 1"1/4	180 mm	5,474	1	-
68764200CB	G 1"1/4	180 mm	5,754	1	-





GR 1230

Pumping group with pump.
Maximum recommended flow rate
3.000 l/h.

Each group is equipped with:

- thermometers to display the delivery and return temperature;
- differential bypass valve;
- check valve;
- shut-off valves for circuits.
(the CB version is insulated).

CODE	SIZE	INTERAXIS			
68763410	G 1"	130 mm	5,582	1	-
68763410CB	G 1"	130 mm	5,862	1	-
68764210	G 1"1/4	180 mm	8,092	1	-
68764210CB	G 1"1/4	180 mm	8,372	1	-

FIXED POINT GROUP

DIMENSIONAL DRAWING

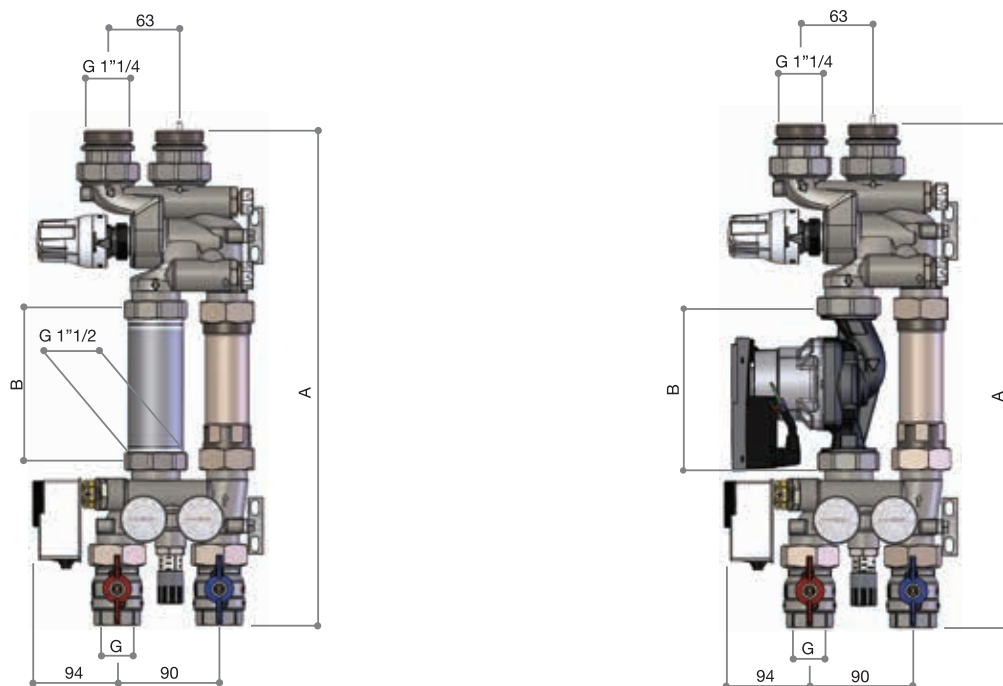

GM 1240

CODE	SIZE	A	B	C	D	E	F	G
68763420	G 1"	437	130	-	-	-	-	G 1"
68764220	G 1 1/4"	537	180	-	-	-	-	G 1 1/4"

GM 1250

CODE	SIZE	A	B	C	D	E	F	G
68763430	G 1"	437	130	-	-	-	-	G 1"
68764230	G 1 1/4"	537	180	-	-	-	-	G 1 1/4"

HYDRAULIC SCHEME

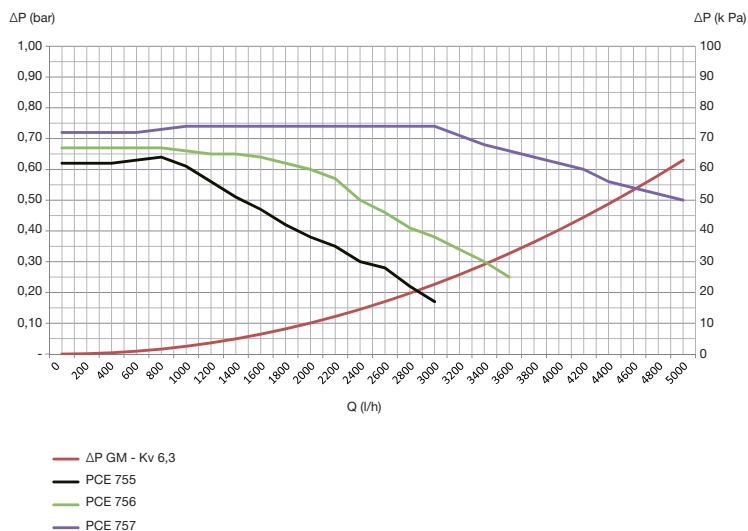
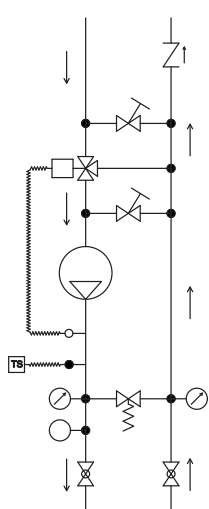

To avoid excessive noise in the system, do not use with ΔP value higher than 0,2-0,25 bar.



FIXED POINT GROUP

**GM 1240**

Fixed-point group without pump.
Maximum recommended flow rate
2.750 l/h.

Each group is equipped with:

- 3-way piston mixing valve;
- thermostatic head with regulation for fixed point;
- bypass valves for manual adjustment for the circuits before and after the mixing valve;
- thermometers to display the delivery and return temperature;
- bypass differential valve;
- check valve;
- shut-off valves for circuits.
(the CB version is insulated).



CODE	SIZE	INTERAXIS			
68763420	G 1"	130 mm	4,946	1	-
68763420CB	G 1"	130 mm	5,226	1	-
68764220	G 1"1/4	180 mm	5,827	1	-
68764220CB	G 1"1/4	180 mm	6,107	1	-

**GM 1250**

Fixed-point group with pump.
Maximum recommended flow rate
2.750 l/h.

Each group is equipped with:

- 3-way piston mixing valve;
- thermostatic head with regulation for fixed point;
- bypass valves for manual adjustment for the circuits before and after the mixing valve;
- thermometers to display the delivery and return temperature;
- bypass differential valve;
- check valve;
- shut-off valves for circuits.
(the CB version is insulated).

CODE	SIZE	INTERAXIS			
68763430	G 1"	130 mm	6,054	1	-
68763430CB	G 1"	130 mm	6,334	1	-
68764230	G 1"1/4	180 mm	8,445	1	-
68764230CB	G 1"1/4	180 mm	8,725	1	-

SLIDING POINT GROUP

DIMENSIONAL DRAWING

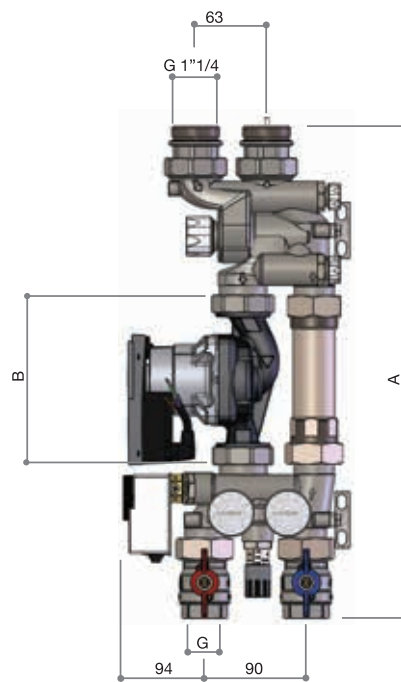
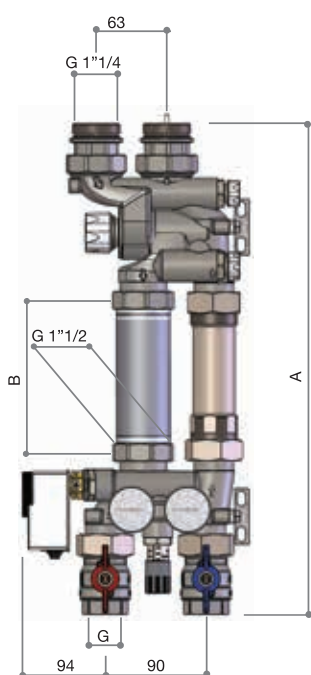

GM 1260

CODE	SIZE	A	B	C	D	E	F	G
68763440	G 1"	437	130	-	-	-	-	G 1"
68764240	G 1 1/4"	537	180	-	-	-	-	G 1 1/4"

GM 1270

CODE	SIZE	A	B	C	D	E	F	G
68763450	G 1"	437	130	-	-	-	-	G 1"
68764250	G 1 1/4"	537	180	-	-	-	-	G 1 1/4"

HYDRAULIC SCHEME

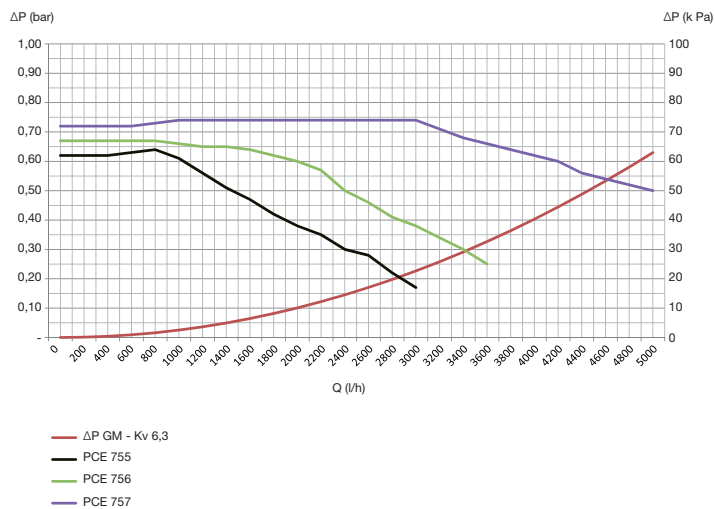
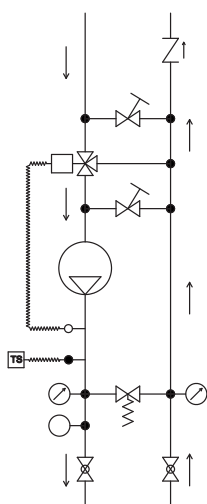

To avoid excessive noise in the system, do not use with ΔP value higher than 0,2-0,25 bar.

SLIDING POINT GROUP

**GM 1260**

Sliding-point group without pump.
Maximum recommended flow rate 2.750 l/h.

Each group is equipped with:

- 3-way piston mixing valve;
- possibility to install a 3-point or 0-10 V motor on a screw with standard connection M30x1,5 mm;
- bypass valves for manual adjustment for the circuits before and after the mixing valve;
- thermometers to display the delivery and return temperature;
- bypass differential valve;
- check valve;
- shut-off for circuits.

(the CB version is insulated)

CODE	SIZE	INTERAXIS			
68763440	G 1"	130 mm	4,800	1	-
68763440CB	G 1"	130 mm	5,080	1	-
68764241	G 1"	180 mm	5,129	1	-
68764240	G 1"1/4	180 mm	5,681	1	-
68764240CB	G 1"1/4	180 mm	5,961	1	-



**GM 1270**

Sliding-point group with pump.
Maximum recommended flow rate 2.750 l/h.

Each group is equipped with:

- 3-way piston mixing valve;
- possibility to install a 3-point or 0-10 V motor on a screw with standard connection M30x1,5 mm;
- bypass valves for manual adjustment for the circuits before and after the mixing valve;
- thermometers to display the delivery and return temperature;
- bypass differential valve;
- check valve;
- shut-off for circuits.

(the CB version is insulated)

CODE	SIZE	INTERAXIS			
68763450	G 1"	130 mm	5,908	1	-
68763450CB	G 1"	130 mm	6,188	1	-
68764250	G 1"1/4	180 mm	8,299	1	-
68764250CB	G 1"1/4	180 mm	8,579	1	-

APPLICATIONS AND ASSEMBLY OPTIONS

GR 1220 - GR 1230

Can be used to connect an external heating source or as pumping unit.

GM 1260 - GM 1270

Can be used for sliding point systems.

GM 1260 - GM 1270

Can be used for sliding point systems.

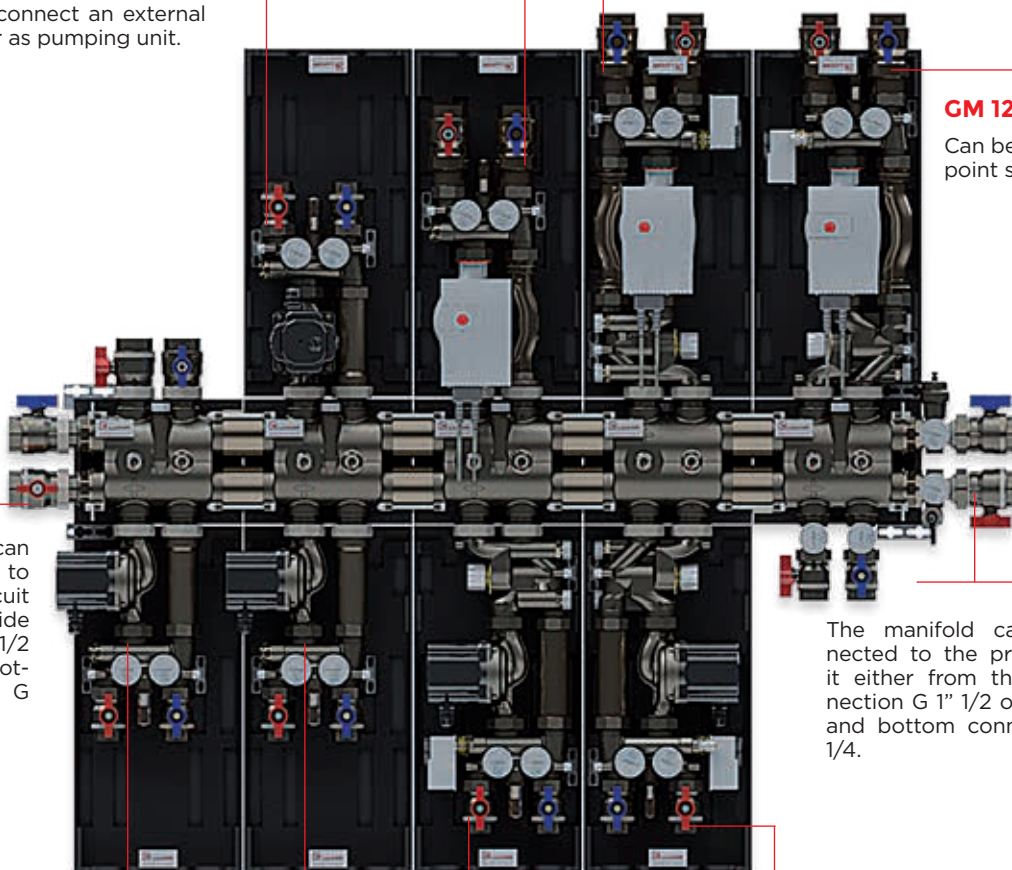

The manifold can be connected to the primary circuit either from the side connection G 1" 1/2 or the top and bottom connection G 1" 1/4.

The manifold can be connected to the primary circuit either from the side connection G 1" 1/2 or by the top and bottom connection G 1" 1/4.

GR 1220 - GR 1230

Can be used to connect an external heating source or as pumping unit.

GM 1260 - GM 1270

Can be used for sliding point systems.

It is possible to reverse the position of the pumping unit or the mixing unit by appropriately connecting the manifolds modules.

MIXING VALVE VM 1200



Mixing valve DN 25. This valve can be combined with the thermostatic head TT 3051 for fixed point systems, or to an actuator with a M30x1,5 thread, closing point 11,5mm and stroke ≥ 3 mm.

Two bypasses are installed on the mixing valve:

- Primary bypass. Enables to generate a recirculation for the pump of the primary circuit (ex. boiler pump).
- Secondary bypass. Allows to generate a recirculation for the pump installed on the group, thus balancing the temperature in the panels and developing thermal inertia for the temperature adjustment system.

Connection to the primary circuit G 1"1/2 male.

Connection to the pump with swivel nut G 1"1/2 and connection to the recirculation socket with swivel nut G 1"1/4.

TECHNICAL DATA

Mixing valve Kvs 5,5 (recirculation) 6,9 (primary exchange)

Maximum recommended flow rate to mixing valve 2.750 l/h (Δp 0,25bar)

Maximum recommended differential pressure on mixing valve 0,25 bar

HYDRAULIC DATA

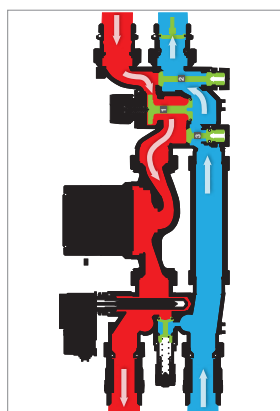

- 1 Mixing valve open
- 2 Primary bypass closed
- 3 Secondary bypass closed



- 1 Mixing valve open
- 2 Primary bypass open
- 3 Secondary bypass open

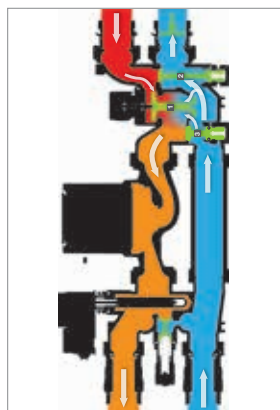

- 1 Mixing valve partially open
- 2 Primary bypass closed
- 3 Secondary bypass closed



- 1 Mixing valve partially open
- 2 Primary bypass open
- 3 Secondary bypass open

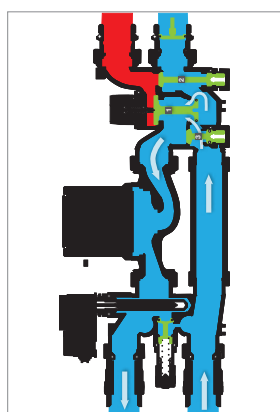

- 1 Mixing valve closed
- 2 Primary bypass closed
- 3 Secondary bypass closed

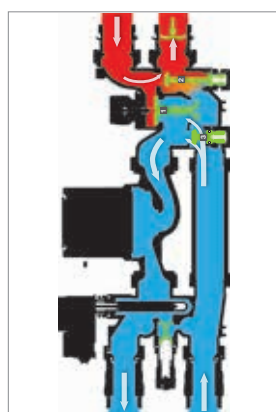

- 1 Mixing valve closed
- 2 Primary bypass open
- 3 Secondary bypass open

CHARACTERISTIC DIAGRAM ACCORDING TO THE STROKE OF THE SCREW

PRIMARY DIAGRAM/RECIRCULATION WITH BYPASS CLOSED

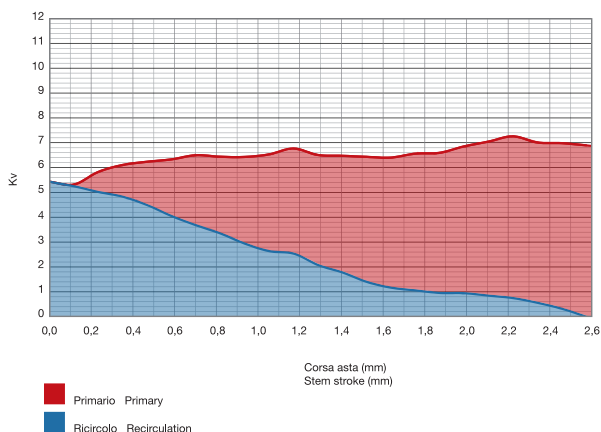

Kv PRIMARY	Kv RECIRCULATION	STEM STROKE	% PRIMARY	% RECIRCULATION
0,00	5,43	closed	0%	100%
0,07	5,25	0,1	1%	99%
0,80	5,02	0,2	14%	86%
1,27	4,83	0,4	21%	79%
1,74	4,49	0,5	28%	72%
2,28	4,05	0,6	36%	64%
2,82	3,68	0,7	43%	57%
3,09	3,35	0,8	48%	52%
3,49	2,94	0,9	54%	46%
3,89	2,64	1,1	60%	40%
4,23	2,54	1,2	62%	38%
4,43	2,08	1,3	68%	32%
4,70	1,78	1,4	73%	27%
5,03	1,40	1,5	78%	22%
5,23	1,17	1,6	82%	18%
5,50	1,06	1,8	84%	16%
5,63	0,96	1,9	85%	15%
5,90	0,95	2,0	86%	14%
6,20	0,85	2,1	88%	12%
6,51	0,75	2,2	90%	10%
6,45	0,56	2,3	92%	8%
6,66	0,32	2,5	95%	5%
6,90	0,00	all open	100%	0%

PRIMARY DIAGRAM/RECIRCULATION WITH BYPASS OPEN

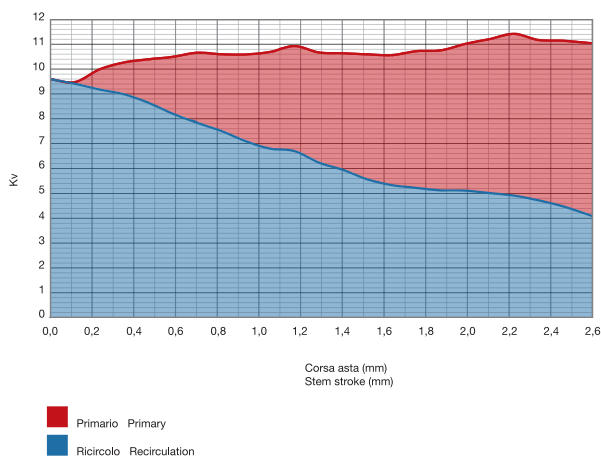

Kv PRIMARY	Kv RECIRCULATION	STEM STROKE	% PRIMARY	% RECIRCULATION
0,00	9,59	closed	0%	100%
0,07	9,41	0,1	1%	99%
0,80	9,18	0,2	8%	92%
1,27	8,99	0,4	12%	88%
1,74	8,65	0,5	17%	83%
2,28	8,21	0,6	22%	78%
2,82	7,84	0,7	26%	74%
3,09	7,51	0,8	29%	71%
3,49	7,10	0,9	33%	67%
3,89	6,80	1,1	36%	64%
4,23	6,70	1,2	39%	61%
4,43	6,24	1,3	42%	58%
4,70	5,94	1,4	44%	56%
5,03	5,56	1,5	48%	52%
5,23	5,33	1,6	50%	50%
5,50	5,22	1,8	51%	49%
5,63	5,12	1,9	52%	48%
5,90	5,11	2,0	54%	46%
6,20	5,01	2,1	55%	45%
6,51	4,91	2,2	57%	43%
6,45	4,72	2,3	58%	42%
6,66	4,48	2,5	60%	40%
6,90	4,16	all open	62%	38%

BYPASS AND MIXING KV VALUE ACCORDING TO THE OBTURATOR TURNS

PRIMARY BYPASS		SECONDARY BYPASS	
CLOSURE TURNS	Kv	CLOSURE TURNS	Kv
1/4	0,30	1/4	0,25
1/2	0,64	1/2	0,59
1	1,32	1	1,27
1 1/2	2,04	1 1/2	1,87
2	2,72	2	2,38
2 1/2	3,48	2 1/2	2,97
3	4,07	3	3,22
3 1/2	4,33	3 1/2	3,56
4	4,58	4	3,73
4 1/2	4,67	4 1/2	3,82
all open	4,67	all open	4,16

ACCESSORIES FOR DISTRIBUTION MANIFOLDS

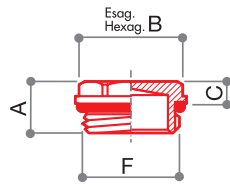

TC 460
End cap with o-ring.

CODE	SIZE	FINISHING	A	B	C	D	E	F	G	H	L			
68559942N	G 1" 1/4	NICKEL-PLATED	25	38	12	-	-	G 1" 1/4	-	-	-	94	30	240
68559948N	G 1" 1/2	NICKEL-PLATED	26	48	16	-	-	G 1" 1/2	-	-	-	160	16	128

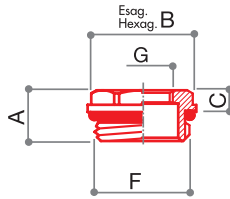

TC 462
Cap with adapter and o-ring.

CODE	SIZE	FINISHING	A	B	C	D	E	F	G	H	L			
68559916N	G 1" 1/2 x G 1"	NICKEL-PLATED	26	48	16	-	-	G 1" 1/2	G 1"	-	-	200	16	128
68559915N	G 1" 1/2 x G 1" 1/4	NICKEL-PLATED	26	48	16	-	-	G 1" 1/2	G 1" 1/4	-	-	124	16	128

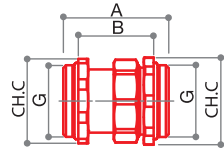

RD 455
Three pieces M-M union fitting with o-ring.

CODE	SIZE	A	B	C	D	E	F	G	H	L			
68994801N	G 1" 1/2	70	50	65	-	-	-	G 1" 1/2	-	-	460	5	40

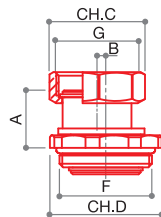

RE 447
Eccentric fitting to assemble groups on manifold CD1210, on the boiler connections side. To be used in pairs.

CODE	SIZE	A	B	C	D	E	F	G	H	L			
68994810N	G 1" 1/2 M x G 1" 1/4 F	30	4,5	46	56	-	G 1" 1/2	G 1" 1/4	-	-	340	5	40

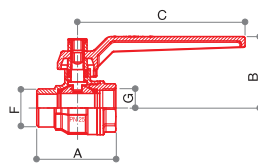

VC 476

Nickel-plated full flow ball valve, without pipe union, with blue or red lever.

CODE	SIZE	A	B	C	D	E	F	G	H	L			
68559829B	G 1"1/2	91	75	150	-	-	G 1"1/2	G 1"1/2	-	-	1400	2	16
68559829R	G 1"1/2	91	75	150	-	-	G 1"1/2	G 1"1/2	-	-	1400	2	16

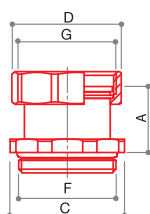

CR 496

Nickel plated nut and fitting with gasket for ball valve VC476 connection.

CODE	SIZE	A	B	C	D	E	F	G	H	L			
67934800	G 1"1/2	32	-	56	52	-	G 1"1/2	G 1"1/2	-	-	280	6	48

INSULATION



CB 1220

Insulation for manifold module CD 1210.

CODE	SIZE	A	B	C	D	E	F	G	H	L			
72000080	G 1"1/4 x G 1"	243	166	138	223	10	135	-	-	-	80	-	1

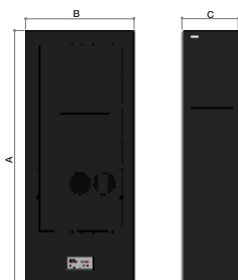

CB 1222

Insulation for pumping and mixing groups.

CODE	SIZE	A	B	C	D	E	F	G	H	L			
Pumping groups													
72000082	G 1" - 130 mm	520	223	135	-	-	-	-	-	-	280	-	1
72000084	G 1"1/4 - 180 mm	520	223	135	-	-	-	-	-	-	280	-	1
Mixing groups													
72000086	G 1" - 130 mm	520	223	135	-	-	-	-	-	-	280	-	1
72000088	G 1"1/4 - 180 mm	520	223	135	-	-	-	-	-	-	280	-	1



A large rectangular area containing 25 horizontal lines, spaced evenly, for writing or drawing.



LUXOR®







7 / FITTINGS

FITTINGS

COMPRESSION FITTINGS FOR COPPER, PLASTIC AND MULTILAYER PIPES



TECHNICAL DATA

		
Max temperature	Max pressure	Nuts
120 °C	10 bar	CW617N UNI EN 12165:2016
		
Fittings	Gaskets OR	Gaskets
CW614N UNI EN 12164:2016	EPDM	Polyethylene

SYSTEM CONNECTIONS



Iron pipe
W 24x19 - TR 91
G 3/4 EK - TR 91/A
G 1/2 - TR 890
G 1/2 - TR 94
G 1/2 - TR 92

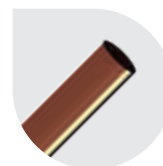

Copper pipe
W 24x19 - TR 91
G 3/4 EK - TR 91/A
G 1/2 - TR 890
G 1/2 - TR 94
G 1/2 - TR 92



Plastic pipe
W 24x19 - TP 95
G 3/4 EK - TP 98
G 1/2 - TP 93



Multilayer pipe
W 24x19 - TP 97
G 3/4 EK - TP 99
G 1/2 - TP 96
G 1/2 F - TP 90

OPERATING INSTRUCTIONS

To avoid inconveniences caused by an improper installation, which could be very costly, it is advisable to follow the below instructions:

• How to prepare the pipe.

1. **Cutting the pipe.** For a correct cut, use suitable shears so as to avoid the ovalization of the pipe and take care that the cut is perpendicular to the pipe axis.

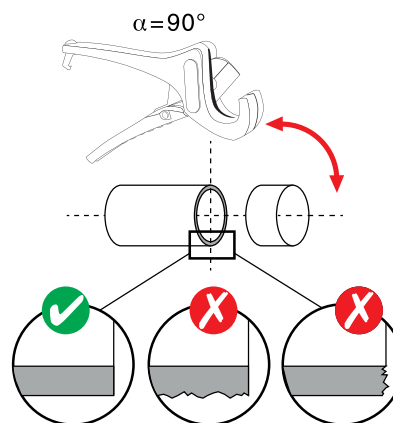

The characteristics of the fluid in the system must be compliant with the UNI 8065: 2019 directive.

2. Calibration. This operation guarantees to obtain a correct internal diameter.

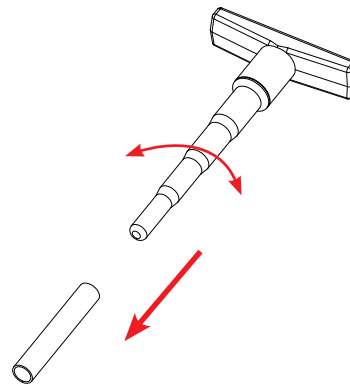

3. Flaring. This operation creates an internal chamfer which eases the insertion of the fitting in the pipe and avoids the displacement of the o-rings from their seat.

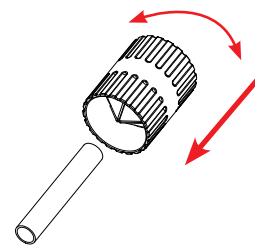

CORRECT ASSEMBLY OF THE COMPRESSION FITTING.

Assemble the parts of the fitting in the same order and direction shown in the below pictures.

FITTINGS FOR COPPER PIPE/MILD STEEL			FITTINGS FOR PLASTIC PIPE	FITTINGS FOR MULTILAYER PIPE
TR 91 • TR 91/A	TR 92	TR 94	TP 93 • TP 95 • TP 98	TP 96 • TP 97 • TP 99
↓	↓	↓	↓	↓

Insert the pipe with its rubber holder inside the fitting, making sure that this part is clean and avoiding to pinch the o-ring.

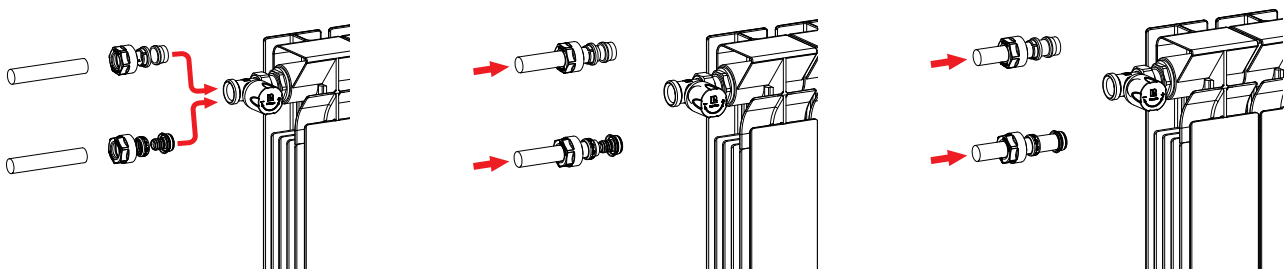

Do not lubricate the rubber parts with oil or mineral based grease: the EPDM compound is compatible only with silicone based lubricants. To avoid any possible mistake, it is advisable to lubricate these parts simply with water.

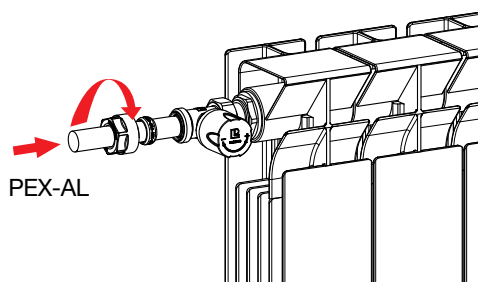
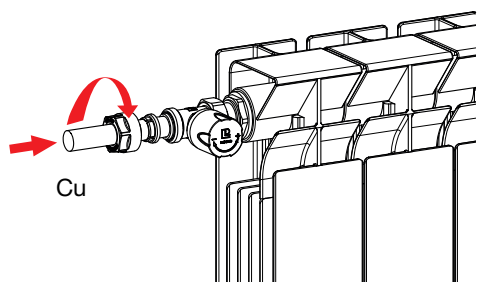
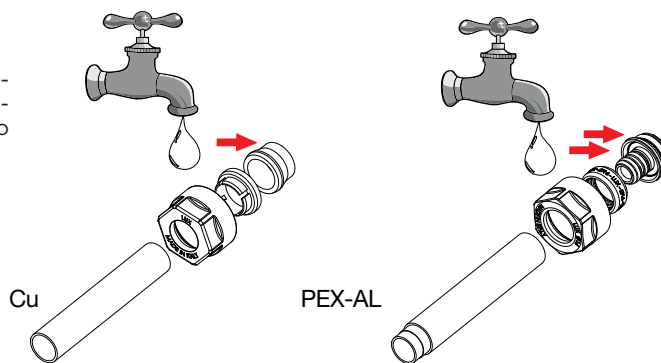

Insert the nut and screw it manually as much as possible and then with a CH 110 key.

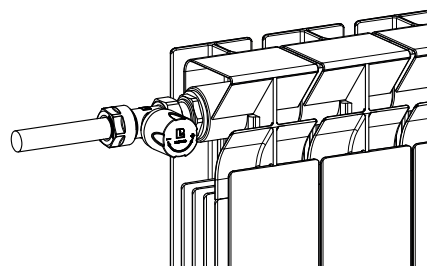
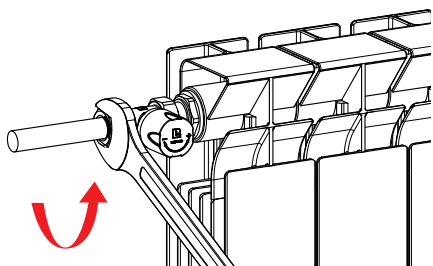

TORQUE

For a correct use of the fittings it is necessary to observe the below chart concerning the nuts torque according to the type of fitting and the type of pipe.



TUBE SIZE	ANNEALED COPPER	SEMI-SOFT COPPER	MILD STEEL	POLYETHYLENE, POLYPROPYLENE, POLYBUTENE	MULTILAYER PEX-AL-PEX
Up to Ø 18 mm	From 35 to 45 Nm	From 60 to 80 Nm	From 60 to 70 Nm	From 40 to 50 Nm	From 25 to 35 Nm
Above Ø 18 mm	-	-	-	From 40 to 50 Nm	From 25 to 35 Nm

FITTINGS FOR COPPER PIPE



TR 92

Compression fitting with brass ogive for copper or mild steel pipe. In compliance with D.M. 174/2004.

CODE	SIZE			
67611400	14 mm	24	100	800
67611500	15 mm	21	100	800

thread G1/2



TR 94

Compression fitting with brass ogive with o-ring for copper or mild steel pipe for underfloor installation.

CODE	SIZE			
67621500	15 mm	20	100	800

thread G1/2



TR 890

Soft compression fitting with PTFE/CV ogive - for copper pipe - thread G1/2.

CODE	SIZE			
68720010	10 mm	26	50	400
68720012	12 mm	25	50	400
68720014	14 mm	20	50	400
68720016	16 mm	19	50	400

thread G1/2



TR 91

Soft compression fitting with EPDM ogive - for copper pipe - thread W24x19.

CODE	SIZE			
67760010	10 mm	52	50	400
67760012	12 mm	44	50	400
67760014	14 mm	42	50	400
67760015	15 mm	40	50	400
67760016	16 mm	38	50	400
67760018	18 mm	36	50	400

thread W24x19



TR 91/A

Soft compression fitting with EPDM ogive - for copper pipe - thread G3/4 eurokonus.

CODE	SIZE			
67761000	10 mm	54	40	320
67761200	12 mm	52	40	320
67761400	14 mm	50	40	320
67761500	15 mm	50	40	320
67761600	16 mm	48	40	320
67761800	18 mm	46	40	320

thread G3/4 eurokonus



FITTINGS FOR POLYETHYLENE, POLYBUTILENE AND POLYPROPYLENE PIPE



TP 93

Compression fitting for polyethylene, polybutilene and polypropylene pipe, thread G 1/2.

CODE	SIZE			
67801208	12 x 2	56	50	400
67801510	15 x 2,5	48	50	400
67801612	16 x 2	45	50	400
67801616	16 x 2,2	44	50	400

thread G1/2



TP 95

Compression fitting for polyethylene, polybutilene and polypropylene pipe, thread W24x19.

CODE	SIZE			
67781008	10,5 x 1,25	62	50	400
67781210	12 x 1	52	50	400
67781209	12 x 1,5	60	50	400
67781208	12 x 2	59	50	400
67781410	14 x 2	60	50	400
67781511	15 x 2	54	50	400
67781510	15 x 2,5	56	50	400
67781613	16 x 1,5	52	50	400
67781612	16 x 2	56	50	400
67781616	16 x 2,2	56	50	400
67781611	16 x 2,5	56	50	400
67781628	16 x 2,8	56	50	400
67781713	17 x 2	50	50	400
67781814	18 x 2	48	50	400
67781813	18 x 2,5	48	50	400
67782016	20 x 2	60	50	400
67782017	20 x 2,8	68	50	400
67782034	20 x 3,4	60	50	400

thread W24x19



TP 98

Compression fitting for polyethylene, polybutilene and polypropylene pipe, thread G3/4 **eurokonus**.

CODE	SIZE			
67841007	10 x 1,2	76	40	320
67841209	12 x 1,5	76	40	320
67841208	12 x 2	76	40	320
67841410	14 x 2	70	40	320
67841510	15 x 2,5	70	40	320
67841613	16 x 1,5	60	40	320
67841618	16 x 1,8	60	40	320
67841612	16 x 2	60	40	320
67841616	16 x 2,2	68	40	320
67841713	17 x 2	58	40	320
67841814	18 x 2	68	40	320
67842016	20 x 2	57	40	320
67842028	20 x 2,8	64	40	320
67842034	20 x 3,4	60	40	320

thread G3/4 eurokonus

FITTINGS FOR POLYETHYLENE MULTILAYERS PEX-AL-PEX PIPE

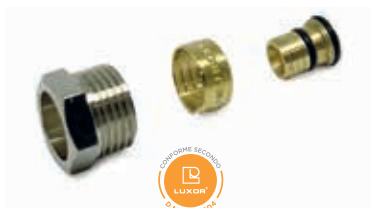

TP 90

Compression fitting for polyethylene multilayer pipe PEX-AL-PEX for G1/2 iron pipe connection.

CODE	SIZE			
67631612	16 x 2	27	50	400

thread G1/2



TP 96

Compression fitting for polyethylene multilayer pipe PEX-AL-PEX, thread G1/2.

CODE	SIZE			
67871410	14 x 2	56	50	400
67871612	16 x 2	57	50	400
67871611	16 x 2,25	52	50	400

thread G1/2



TP 97

Compression fitting for polyethylene multilayer pipe PEX-AL-PEX, thread W24x19.

CODE	SIZE			
67821410	14 x 2	54	50	400
67821612	16 x 2	52	50	400
67821611	16 x 2,25	52	50	400
67821626	16,2 x 3	52	50	400
67821711	17 x 2,75	49	50	400
67821713	17 x 2	50	50	400
67821712	17 x 2,5	50	50	400
67821814	18 x 2	50	50	400
67822016	20 x 2	66	50	400
67822017	20 x 2,25	64	50	400
67822015	20 x 2,5	62	50	400
67822014	20 x 3	62	50	400

thread W24x19

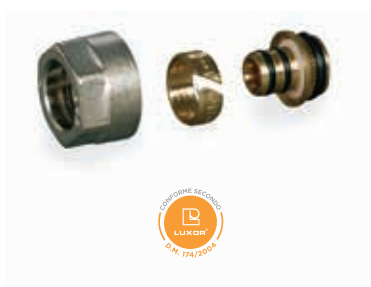

TP 99

Compression fitting for polyethylene multilayer pipe PEX-AL-PEX, thread G3/4 eurokonus.

CODE	SIZE			
67861210	12,2 x 1,3	74	40	320
67861410	14 x 2	78	40	320
67861512	15 x 1,5	63	40	320
67861612	16 x 2	74	40	320
67861611	16 x 2,25	74	40	320
67861610	16,2 x 3	74	40	320
67861713	17 x 2	74	40	320
67861712	17 x 2,5	74	40	320
67861711	17 x 2,75	70	40	320
67861814	18 x 2	74	40	320
67862016	20 x 2	78	40	320
67862017	20 x 2,25	76	40	320
67862015	20 x 2,5	74	40	320
67862014	20 x 3	72	40	320

thread G3/4 eurokonus

CHROME AND PAINTED COMPRESSION FITTINGS FOR COPPER PIPE



CHROME



WHITE



BLACK

TR 91/AC

Soft compression fitting with EPDM ogive - for copper pipe - thread G3/4 eurokonus.

CODE	SIZE	FINISH			
67761000C	10 mm	CHROME	57	20	240
67761200C	12 mm	CHROME	54	20	240
67761400C	14 mm	CHROME	51	20	240
67761500C	15 mm	CHROME	48	20	240
67761600C	16 mm	CHROME	46	20	240
67761000B	10 mm	WHITE	57	20	240
67761200B	12 mm	WHITE	54	20	240
67761400B	14 mm	WHITE	51	20	240
67761500B	15 mm	WHITE	48	20	240
67761600B	16 mm	WHITE	46	20	240
67761000N	10 mm	BLACK	57	20	240
67761200N	12 mm	BLACK	54	20	240
67761400N	14 mm	BLACK	51	20	240
67761500N	15 mm	BLACK	48	20	240
67761600N	16 mm	BLACK	46	20	240

thread G3/4 eurokonus

CHROME-PLATED AND PAINTED COMPRESSION FITTINGS FOR POLYETHYLENE, POLYBUTYLENE AND POLYPROPYLENE PIPE



CHROME



WHITE



BLACK

TP 98/C

Compression fitting for polyethylene, polybutylene and polypropylene pipe, thread G3/4 eurokonus.

CODE	SIZE	FINISH			
67841410C	14 x 2	CHROME	65	20	240
67841612C	16 x 2	CHROME	61	20	240
67841713C	17 x 2	CHROME	58	20	240
67841814C	18 x 2	CHROME	59	20	240
67842016C	20 x 2	CHROME	57	20	240
67841410B	14 x 2	WHITE	65	20	240
67841612B	16 x 2	WHITE	61	20	240
67841713B	17 x 2	WHITE	58	20	240
67841814B	18 x 2	WHITE	59	20	240
67842016B	20 x 2	WHITE	57	20	240
67841410N	14 x 2	BLACK	65	20	240
67841612N	16 x 2	BLACK	61	20	240
67841713N	17 x 2	BLACK	58	20	240
67841814N	18 x 2	BLACK	59	20	240
67842016N	20 x 2	BLACK	57	20	240

thread G3/4 eurokonus

CHROME-PLATED AND PAINTED COMPRESSION FITTINGS FOR POLYETHYLENE MULTILAYERS PEX-AL-PEX PIPE



CHROME





WHITE



BLACK

TP 99/C

Compression fitting for polyethylene multilayer pipe PEX-AL-PEX, thread G3/4 **eurokonus**.

CODE	SIZE	FINISH			
67861410C	14 x 2	CHROME	67	20	240
67861612C	16 x 2	CHROME	65	20	240
67861611C	16 x 2.25	CHROME	60	20	240
67861713C	17 x 2	CHROME	60	20	240
67861814C	18 x 2	CHROME	61	20	240
67862016C	20 x 2	CHROME	59	20	240
67861410B	14 x 2	WHITE	67	20	240
67861612B	16 x 2	WHITE	65	20	240
67861611B	16 x 2.25	WHITE	60	20	240
67861713B	17 x 2	WHITE	60	20	240
67861814B	18 x 2	WHITE	61	20	240
67862016B	20 x 2	WHITE	59	20	240
67861410N	14 x 2	BLACK	67	20	240
67861612N	16 x 2	BLACK	65	20	240
67861611N	16 x 2.25	BLACK	60	20	240
67861713N	17 x 2	BLACK	60	20	240
67861814N	18 x 2	BLACK	61	20	240
67862016N	20 x 2	BLACK	59	20	240

thread G3/4 eurokonus

IN-WALL CONNECTIONS FOR THE DISTRIBUTION WITH REMOVABLE PIPES

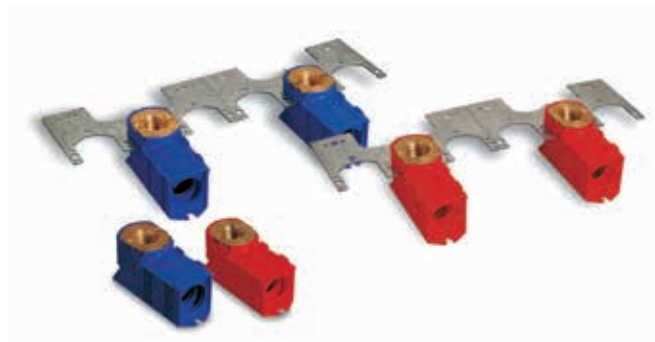

CONSTRUCTIVE FEATURES

Luxor in-wall connections are designed to meet the modern necessity to use removable plastic pipes in heating and sanitary distribution systems.

The main features of these products are:

- easy pipe laying;
- possibility of doing maintenance without damaging the walls, working inside the plastic boxes which isolate the connections from the plaster;
- low noise of the system thanks to the absence of junctions which create noise;
- aesthetic quality of the end result.

The fittings are produced in DZR brass CW626N UNI EN 12165:2016. All gaskets are in peroxide cured EPDM. The plastic boxes containing the connections consist of talc filled polypropylene.

By using the chrome-plated copper connection pipe M 528, the tightness is guaranteed by o-rings and the aesthetic effect ensured by a chrome-plated pipe always aligned both with

TECHNICAL DATA



Max temperature

120 °C



Max pressure

10 bar

the fitting and the wall.

The brackets SS 1982 are in galvanised iron Fe Z100 EN 10142-92 and divisible.

These items allow to lay the connections quickly and safely, at the required depth and with the correct interaxes for the connection to sanitary appliances.

All the fittings for copper and plastic pipes are supplied without assembled fittings.



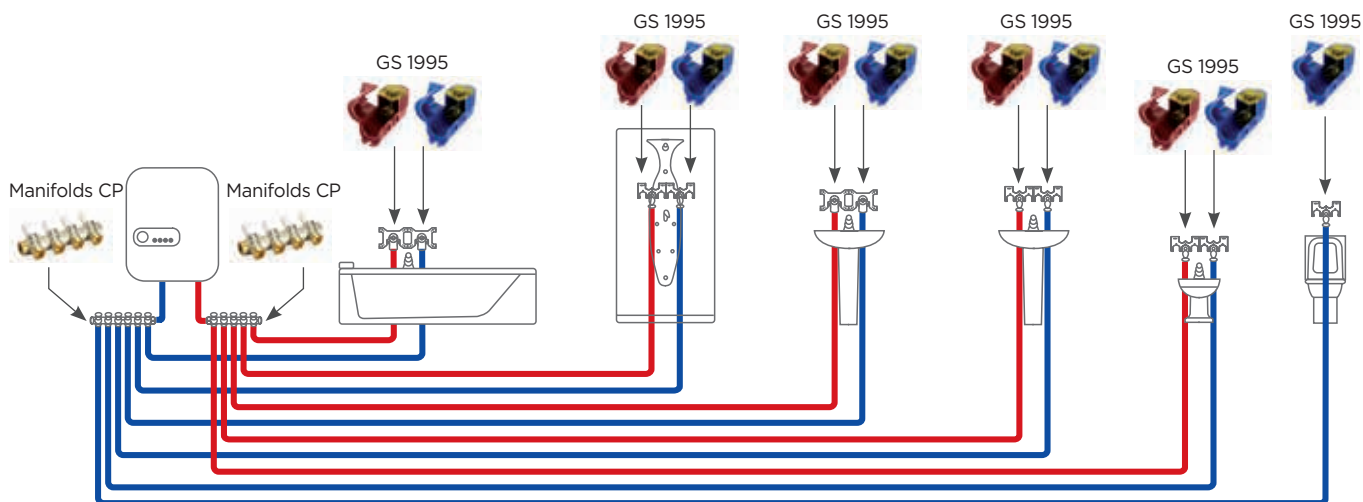

SANITARY DISTRIBUTION SYSTEM WITH ONE INLET FOR EACH USER POINT

This is the most common type of system, each user point is directly connected to one outlet of the distribution manifold.

The **advantages** of this type of system are:

- constant pressure for each user point;
- possibility to adjust the flow rate for each single user point;
- easy maintenance.

The **disadvantages** are:

- a very large quantity of pipes used;
- large distribution boxes.

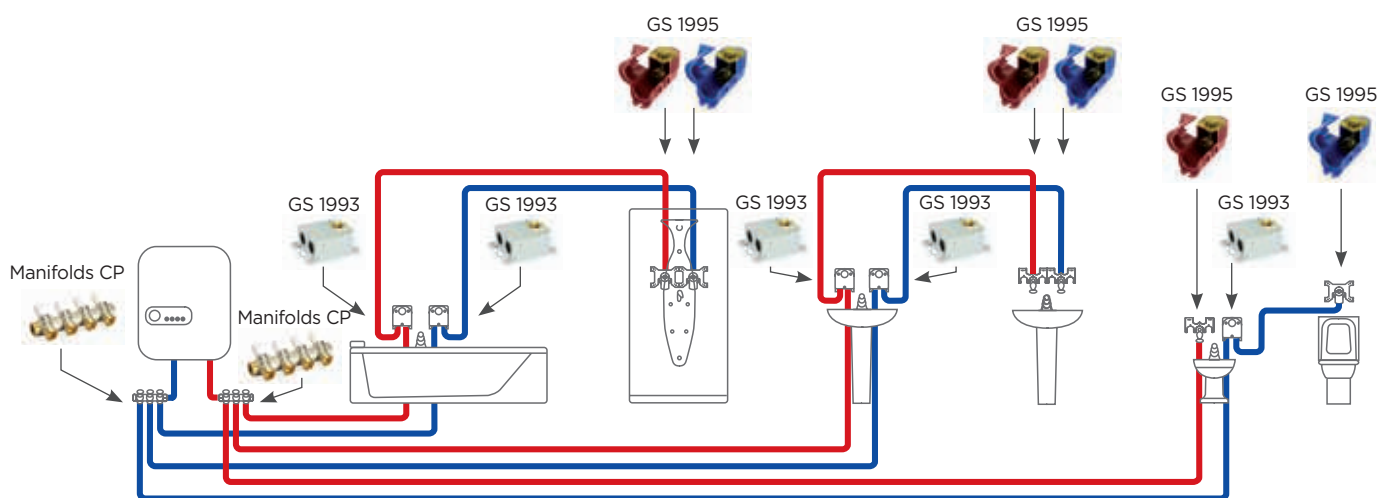

BLOCK SANITARY DISTRIBUTION SYSTEM

In this type of system, the user point are divided in groups.

The **advantages** are:

- low implementation costs;
- less space occupied by pipes and distribution box.

The **disadvantages** are:

- in case of simultaneous use, the flow is subdivided among the user points.

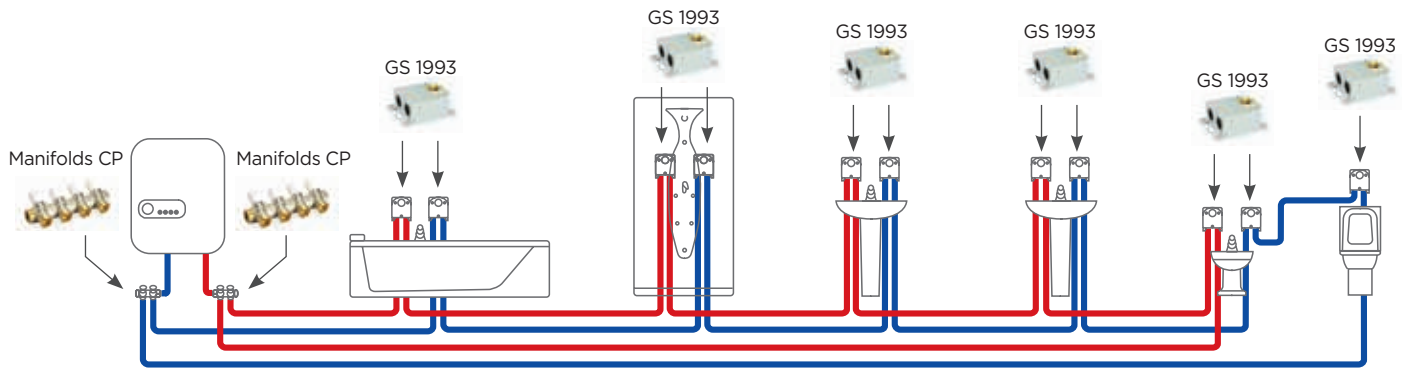

SINGLE-PIPE SYSTEM FOR SANITARY DISTRIBUTION

This type of system is the simplest.

The **advantages** of this type of system are:

- ease of construction;
- minimum space for pipes and distribution box;
- low construction cost.

The **disadvantages** are:

- in case of simultaneous use, the flow is subdivided among the user points.

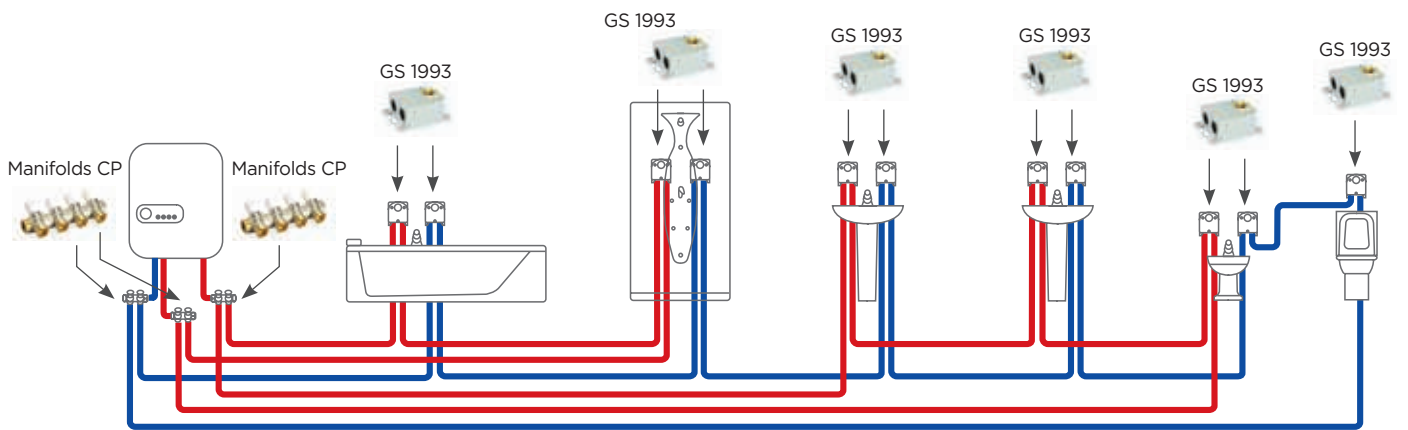

SANITARY DISTRIBUTION SYSTEM WITH COMFORT RECIRCULATION

This type of system creates a recirculation for hot water.

The **advantages** of such a system are:

- maximum comfort, since the hot water is immediately available, no matter the distance from the boiler.

The **disadvantages** are:

- high implementation costs;
- use of insulated pipes to reduce the heat loss;
- need to create a specific recirculation circuit.

IN-WALL CONNECTIONS FOR THE DISTRIBUTION WITH REMOVABLE PIPES

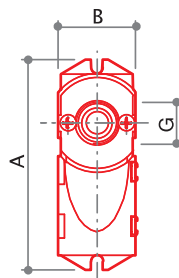

GS 1995

90° in-wall single elbow fitting, blue or red, without bracket, with brass cap and o-ring for tightness testing.

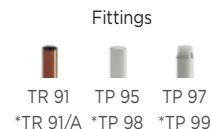

CODE	SIZE	A	B	C	D	E	F	G	H	L			
66004100B	G 1/2 x (W24x19)	104	38	50	-	-	W24x19	G 1/2	-	-	124	8	64
66004100R	G 1/2 x (W24x19)	104	38	50	-	-	W24x19	G 1/2	-	-	124	8	64
66004102B*	G 1/2 x G 3/4 EK	104	38	50	-	-	G 3/4 EK	G 1/2	-	-	127	8	64
66004102R*	G 1/2 x G 3/4 EK	104	38	50	-	-	G 3/4 EK	G 1/2	-	-	127	8	64



RC 914

90° in-wall elbow fitting.

CODE	SIZE	FINISHING						
68549899	G 1/2 x (W24x19)	YELLOW SURFACE	TR 91	TP 95	TP 97	75	30	240
68549901	G 1/2 x G 3/4 EK	YELLOW SURFACE	TR 91/A	TP 98	TP 99	78	30	240
68549899N	G 1/2 x (W24x19)	NICKEL-PLATED	TR 91	TP 95	TP 97	75	30	240
68549901N	G 1/2 x G 3/4 EK	NICKEL-PLATED	TR 91/A	TP 98	TP 99	78	30	240

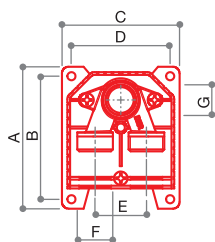

CS 1993

Double connection, single pipe system, with in-wall housing.

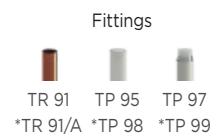

CODE	SIZE	A	B	C	D	E	F	G	H	L			
66002200	G 1/2 x (W24x19)	105	91	87	73	38	W24x19	G 1/2	-	-	288	6	48
66002201*	G 1/2 x G 3/4 EK	105	91	87	73	38	G 3/4 EK	G 1/2	-	-	294	6	48

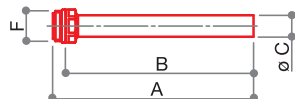

M 528

Chrome-plated copper connection pipe with soft seal for in-wall distribution boxes.

CODE	SIZE	A	B	C	D	E	F	G	H	L			
67510015	G 1/2 x (Ø 15 x 140)	140	131	15	-	-	G 1/2	-	-	-	70	35	280
67520015	G 1/2 x (Ø 15 x 175)	175	166	15	-	-	G 1/2	-	-	-	80	30	240

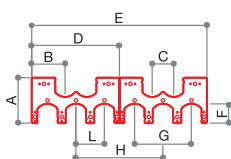

SS 1982

Double bracket, divisible into two single brackets, for in-wall connections GS 1995, GS 1996, interaxis 38-50-100-153.

CODE	SIZE	A	B	C	D	E	F	G	H	L			
66004000	-	80	58	38	154	308	34	100	153	50	142	25	150

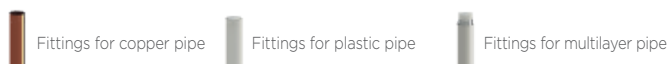

FITTINGS FOR COPPER, PLASTIC AND MULTILAYER PIPE



TECHNICAL DATA



Max temperature

120 °C



Max pressure

10 bar

CONSTRUCTIVE FEATURES

Luxor fittings come in raw (yellow) or nickel plated brass of the following types:

- dezincification resistant CW626N UNI EN 12165:2016
- with limited lead content as prescribed by current standards: CW617N UNI EN 12165:2016.

O-rings and gaskets are in peroxide cured EPDM.

The bracket SS 1984 consists of galvanised iron Fe Z100 EN 10142-92.

This item allows for a quick and safe installation of the fittings with the correct interaxes.

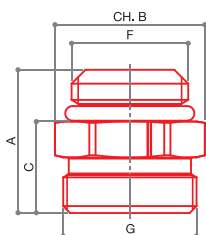

RD 900

Straight fitting with o-ring for connection to distribution manifolds CD series.

Fittings

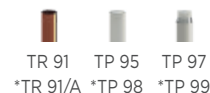

CODE	SIZE	A	B	C	D	E	F	G	H	L	FINISHING			
68559824	G 1/2 x (W24x19)	26	24	16.5	-	-	G 1/2	W24x19	-	-	YELLOW SURFACE	42	50	400
68552700*	G 1/2 x G 3/4 EK	26	27	17	-	-	G 1/2	G 3/4 EK	-	-	YELLOW SURFACE	51	50	400
68559817N**	G 3/8 x (W24x19)	24	24	15	-	-	G 3/8	W24x19	-	-	NICKEL-PLATED	36	100	800
68559824N	G 1/2 x (W24x19)	26	24	16.5	-	-	G 1/2	W24x19	-	-	NICKEL-PLATED	42	50	400
68552700N*	G 1/2 x G 3/4 EK	26	27	17	-	-	G 1/2	G 3/4 EK	-	-	NICKEL-PLATED	51	50	400

** Discontinued article

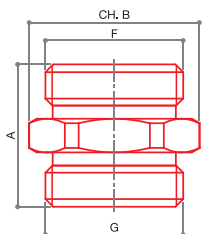

RD 902

Straight fitting M-M.

Fittings

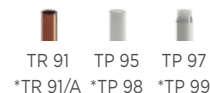

CODE	SIZE	A	B	C	D	E	F	G	H	L			
68549824N	G 1/2 x (W24x19)	32.5	24	-	-	-	R 1/2	W24x19	-	-	46	50	400
68549827N	G 3/4 x (W24x19)	27	27	-	-	-	G 3/4 EK	W24x19	-	-	46	50	400
68559822N	(W24x19) x (W24x19)	26.5	24	-	-	-	W24x19	W24x19	-	-	42	50	400
68559823N*	G 3/4 EK x G 3/4 EK	27.5	30	-	-	-	G 3/4 EK	G 3/4 EK	-	-	62	50	400



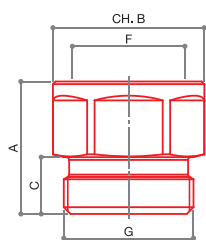

RD 903
Straight fitting F-M.

Fittings



CODE	SIZE	A	B	C	D	E	F	G	H	L			
68549838N	G 1/2 x (W24x19)	24.5	25	10.5	-	-	G 1/2	W24x19	-	-	42	50	400
68549739N*	G 1/2 x G 3/4 EK	26	27	10.5	-	-	G 1/2	G 3/4 EK	-	-	60	50	400
68549743N*	G 3/4 x G 3/4 EK	25	30	10.5	-	-	G 3/4	G 3/4 EK	-	-	51	50	400
68549740N	G 3/4 x (W24x19)	25	31	10.5	-	-	G 3/4	W24x19	-	-	58	50	400
68549741N	(W24x19) x (W24x19)	25	27	10	-	-	W24x19	W24x19	-	-	48	50	400
68549742N**	(W24x19) x G 1/2	24	27	10	-	-	W24x19	G 1/2	-	-	40	50	400

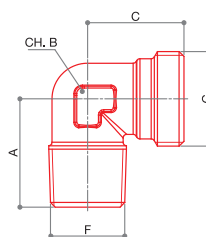

RC 904
Elbow fitting M-M.

Fittings

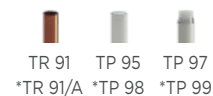

CODE	SIZE	A	B	C	D	E	F	G	H	L			
68549847N	G 1/2 x (W24x19)	30	20	27	-	-	R 1/2	W24x19	-	-	64	50	400
68549746N*	G 1/2 x G 3/4 EK	30	20	27	-	-	R 1/2	G 3/4 EK	-	-	70	30	240

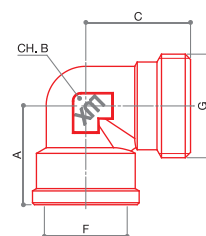

RC 905
Elbow fitting F-M.

Fittings

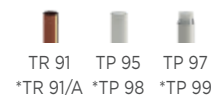

CODE	SIZE	A	B	C	D	E	F	G	H	L			
68549856N	G 1/2 x (W24x19)	25	20	26.5	-	-	G 1/2	W24x19	-	-	79	50	400
68549755N*	G 1/2 x G 3/4 EK	25	20	26.5	-	-	G 1/2	G 3/4 EK	-	-	76	30	240
68549757N*	G 3/4 x G 3/4 EK	36.5	25	33	-	-	G 3/4	G 3/4 EK	-	-	148	25	200

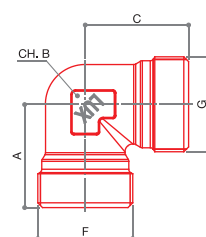

RC 906
Elbow fitting M-M.

Fittings

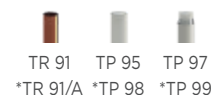

CODE	SIZE	A	B	C	D	E	F	G	H	L			
68549865N	(W24x19) x (W24x19)	26	20	26	-	-	W24x19	W24x19	-	-	62	50	400
68549747N*	G 3/4 EK x G 3/4 EK	33	25	33	-	-	G 3/4 EK	G 3/4 EK	-	-	145	25	200

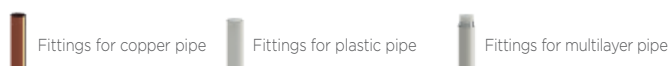

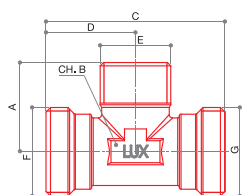

RT 907
T fitting MxMxM.

Fittings

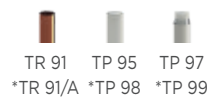

CODE	SIZE	A	B	C	D	E	F	G	H	L			
68549870N	G 1/2 x (W24x19) x (W24x19)	30	20	53	26.5	G 1/2	W24x19	W24x19	-	-	82	30	240
68549770N*	G 1/2 x G 3/4 EK x G 3/4 EK	27	20	53	26.5	G 1/2	G 3/4 EK	G 3/4 EK	-	-	86	25	200

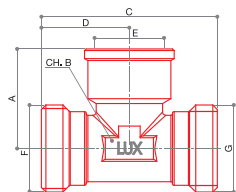

RT 908
T fitting FxMxM.

Fittings

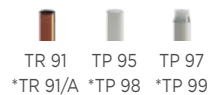

CODE	SIZE	A	B	C	D	E	F	G	H	L			
68549879N	G 1/2 x (W24x19) x (W24x19)	30	20	53	26.5	G 1/2	W24x19	W24x19	-	-	98	30	240
68549779N*	G 1/2 x G 3/4 EK x G 3/4 EK	30	20	53	26.5	G 1/2	G 3/4 EK	G 3/4 EK	-	-	96	25	200

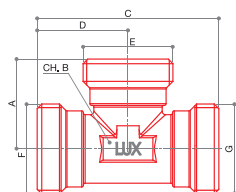

RT 911
T fitting.

Fittings

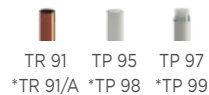

CODE	SIZE	A	B	C	D	E	F	G	H	L			
68549890N	(W24x19) x (W24x19) x (W24x19)	26.5	20	53	26.5	W24x19	W24x19	W24x19	-	-	78	30	240
68549790N*	G 3/4 EK x G 3/4 EK x G 3/4 EK	26.5	20	53	26.5	G 3/4 EK	G 3/4 EK	G 3/4 EK	-	-	96	25	200

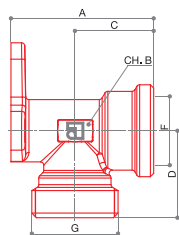

RC 912

Wall elbow fitting with flange.

Fittings

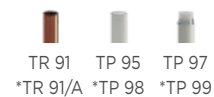

CODE	SIZE	A	B	C	D	E	F	G	H	L			
69549895N	G 1/2 x (W24x19)	43	19	24	26.5	-	G 1/2	W24x19	-	-	109	30	240
69549795N*	G 1/2 x G 3/4 EK	43.5	19	24	26.5	-	G 1/2	G 3/4 EK	-	-	100	25	200
69549794N*	G 3/4 x G 3/4 EK	57	21	37	27	-	G 3/4	G 3/4 EK	-	-	138	20	160

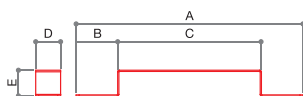

SS 1984

Bracket for wall fitting with flange art.
RC 912 and RM.

CODE	SIZE	A	B	C	D	E	F	G	H	L			
66001200	-	382	70	242	42	43.5	-	-	-	-	280	-	50



RD 923

Straight fitting with male connection and fixed rubber holder for multilayer pipe.

CODE	SIZE			
69549925N	G 3/4 x 25 x 2,5	170	15	120
69549926N	G 3/4 x 26 x 3	172	15	120
69549927N	G 1" x 32 x 3	255	12	96



RC 480

3-piece elbow fitting with o-ring.

CODE	SIZE	FINISHING			
67952100	G 1/2	YELLOW SURFACE	128	25	200
67952700	G 3/4	YELLOW SURFACE	212	15	120
67953400	G 1"	YELLOW SURFACE	372	8	64
67952100N	G 1/2	NICKEL-PLATED	128	25	200
67952700N	G 3/4	NICKEL-PLATED	212	15	120
67953400N	G 1"	NICKEL-PLATED	372	8	64



**RD 482**

3-piece straight fitting with o-ring.

CODE	SIZE	FINISHING			
67972100	G 1/2	YELLOW SURFACE	105	30	240
67972700	G 3/4	YELLOW SURFACE	175	15	120
67973400	G 1"	YELLOW SURFACE	303	12	96
67972100N	G 1/2	NICKEL-PLATED	105	30	240
67972700N	G 3/4	NICKEL-PLATED	175	15	120
67973400N	G 1"	NICKEL-PLATED	303	12	96



**RC 481**

Nickel-plated 3-piece elbow fitting with double o-ring.

CODE	SIZE			
67952101N	G 1/2	128	20	160
67952701N	G 3/4	212	12	96
67953401N	G 1"	372	6	48

**RD 483**

Nickel-plated 3-piece straight fitting with double o-ring.

CODE	SIZE			
67972101N	G 1/2	106	25	200
67972701N	G 3/4	162	12	96
67973401N	G 1"	256	10	80

**CH 110**

Wrench key for compression fittings.

CODE	SIZE			
67822724	CH 24-27 mm	352	10	80

ARTICLE	PAG.
DD 21	26
DS 22	26
DD 25	27
DS 26	27
DCD 29/A	70
DD 31	29
DD 31/A	32
DS 32	29
DS 32/A	32
DCS 33/A	69
DD 38	30
DD 38/A	33
DS 39	30
DS 39/A	33
KT 58/A	65
RD 58/A	68
KT 59/A	63
RS 59/A	68
KT 69/A	64
RCD 69/A	69
KT 73/A	64
RCS 73/A	70
DD 78/A	69
DS 79/A	68
M 81	79
M 83	80
M 85	80
M 86	79
M 87	79
M 88	79
DS 89/A	52
TP 90	319
TR 91	317
TR 91/A	317
TR 91/AC	320
TR 92	317
TP 93	318
TR 94	317
TP 95	318
TP 96	319
TP 97	319
TP 98	318
TP 98/C	320
TP 99	319
TP 99/C	321
CD 100	161
RD 101	8
CD 101	161
RS 102	8

ARTICLE	PAG.
RD 105	9
RS 106	9
CH 110	330
RD 111	10
RD 111/A	12
CH 111	105
RS 112	10
RS 112/A	12
CH 112	105
RD 118	11
RD 118/A	13
RS 119	11
RS 119/A	13
DD 121	8
DS 122	8
DD 125	9
DS 126	9
DD 131	10
DD 131/A	12
DS 132	10
DS 132/A	12
DD 138	11
DD 138/A	13
DS 139	11
DS 139/A	13
KT 146	51
KT 159/A	51
M 171	99
M 172	100
M 173	99
M 174	100
M 175	99
M 176	100
M 177	99
M 178	100
KT 201	22
RD 201	25
KT 202	22
RS 202	25
KT 205	22
RD 205	25
KT 206	22
RS 206	25
KT 208	23
KT 208/A	24
RD 208	28
RD 208/A	31
KT 209	23
KT 209/A	24

ARTICLE	PAG.
RS 209	28
RS 209/A	31
KT 211	23
KT 211/A	24
RD 211	28
RD 211/A	31
KT 212	23
KT 212/A	24
RS 212	28
RS 212/A	31
BT 242	38
DT 242	200
TM 245	105
KT 258/A	60
RD 258/A	65
KT 259/A	60
RS 259/A	65
KT 269/A	60
RCD 269/A	66
KT 273/A	61
RCS 273/A	66
MT 282	83
M 300	86
M 320	86
M 320/A	87
MD 321/A	34
MS 321/A	34
MD 321/A	97
MS 321/A	97
M 322	87
M 330	30
M 330/A	33
M 330	86
M 330/A	87
MS 331/A	34
MD 331/A	34
MS 331/A	97
MD 331/A	97
M 332	27
M 332	87
M 341	92
M 341/A	93
M 351	92
M 351/A	93
M 361	92
M 361/A	93
M 371	92
M 371/A	93
CP 402	111

ARTICLE	PAG.	ARTICLE	PAG.	ARTICLE	PAG.
CP 403	111	CD 459	151	RC 480	329
CP 404	111	CD 460	152	VC 481	195
CP 412	112	TC 460	195	VC 481	225
CP 413	112	TC 460	201	RC 481	330
CC 413	141	TC 460	310	RD 482	330
CP 414	112	CD 461	151	SA 483	208
CC 414	141	CP 462	120	SA 483/A	208
CC 415	141	CP 462/FR	127	SA 483/B	208
CC 416	141	CD 462	152	RD 483	330
CP 422	113	TC 462	201	SD 484	208
CP 423	113	TC 462	310	CF 485	216
CP 424	113	CP 463	120	RT 487	207
TC 430	201	CP 463/FR	127	RT 488	207
CP 432	118	CP 464	120	TC 488	208
CP 432/FR	125	CP 464/FR	127	CT 488	216
CP 433	118	TC 464	202	CR 489	205
CP 433/FR	125	CD 465	166	RTA 489	207
CP 434	118	TC 465	202	CT 489	216
CP 434/FR	125	CD 465M	172	AC 489	217
TC 435	202	CD 466	155	CR 490	205
IU 436	121	CD 467	167	RTR 490	207
IU 436	128	CD 468	166	CF 490	216
IU 437	121	CD 468M	172	AC 490	217
IU 437	128	CD 469	167	CR 491	205
IU 438	137	VS 470	224	CF 491	217
TC 440	202	VC 471	222	CR 492	205
CP 442	114	VC 471/A	222	SA 492	209
CP 443	114	VC 472	223	CF 492	217
CP 444	114	CD 473	170	SA 494	209
TC 445	202	CD 473M	173	SC 496	214
CD 446	155	CD 474	159	SC 496/A	214
RE 447	310	CD 474/1	204	SC 496/B	214
CD 448	157	CT 474	215	CR 496	311
CD 448/1	203	VC 475	223	SC 497	214
CD 449	157	VC 476	223	CR 498	104
CD 449/1	203	VCS 476	224	CR 498	206
TC 450	201	VC 476	311	CR 498/A	206
CD 451	149	CD 477	171	CR 498/B	206
CP 452	119	AC 477	215	CR 499	206
CP 452/FR	126	CF 477	215		500
CP 453	119	VCS 477	225		501
CP 453/FR	126	CD 478	170	KT 502	106
CP 454	119	VCS 478	224		505
CP 454/FR	126	CD 478M	173		507
RD 455	206	CD 479	171		508
RD 455	310	AC 479	215		508/B
CD 456	149	CF 479	215		509
CD 457	150	VCS 479	225		512
RD 458	205	VCG 480	224		513

ARTICLE	PAG.	ARTICLE	PAG.	ARTICLE	PAG.
515	105	VS 603	229	CD 878	154
516	210	VS 603/S	230	CD 879	157
517	104	VS 603/S	266	CD 880	157
518	104	VS 604/A	228	CD 881	158
M 520	107	VS 604/S	229	CD 882	158
M 521	107	VS 604/S	266	TR 890	317
M 522	107	VS 605	229	RD 900	326
M 523	107	VS 606	229	RD 901	203
M 524	107	VS 610	230	RD 902	326
M 525	107	CH 620	230	RD 903	327
M 526	108	VS 620	230	RC 904	327
M 528	106	KC 650	204	RC 905	327
M 528	325	VM 650	233	RC 906	327
M 529	104	KC 651	204	RT 907	328
M 530	104	KC 652	204	RT 908	328
M 531	104	VM 652	233	VS 910	231
M 532	108	KC 653	204	VS 911	231
CV 532	135	VZ 700	236	RT 911	328
M 533	108	SM 700	236	VS 912	232
CV 533	135	VZ 702	236	RC 912	329
CV 534	135	VZ 704	236	VS 913	232
535	106	VZ 712	236	RC 914	325
536	106	VB 750	227	VS 920	232
PS 540	200	FM 750	254	RD 923	329
PS 541	283	VB 751	227	VS 930	232
CV 552	136	VB 752	227	CX 1000	190
CV 553	136	PCEEI 752	286	AC 1180	265
CV 554	136	VB 753	227	GSP 1180	265
555	210	VB 755	227	GSP 1182	265
560	210	PCE 756	286	GP 1190	243
563	210	PCE 757	286	KA 1191	248
567	211	TZ 800	286	GM 1192	259
571	121	CD 860	149	GM 1193	259
571	128	CD 861	150	GR 1194	240
573	137	CD 862	151	GM 1195	240
574	105	CD 863	152	GM 1197	240
576	105	CD 864	151	CB 1200	259
578	105	CD 865	152	CB 1205	209
580	105	CD 867	159	CB 1205	259
580	121	CD 868	159	CD 1210	300
580	128	CD 869	160	GR 1220	302
580	137	CD 870	160	CB 1220	311
583	105	CD 871	155	CB 1222	311
584	107	CD 872	155	GR 1230	302
586	107	CD 873	156	GM 1240	304
VS 601	228	CD 874	156	GM 1250	304
VS 601/S	230	CD 875	153	GM 1260	306
VS 601/S	266	CD 876	153	GM 1270	306
VS 602	228	CD 877	154	SM 1346	288

ARTICLE	PAG.	ARTICLE	PAG.	ARTICLE	PAG.
SM 1348	288	CX 2478	189	CD 3446	154
CE 1370	265	CX 2478M	193	CD 3459	162
CD 1446	153	CD 2479	169	CD 3460	163
CD 1446/1	203	RD 2501	26	CD 3461	162
CD 1448	158	RS 2502	26	CD 3462	163
CD 1449	158	RD 2505	27	CD 3466	154
CD 1466	153	RS 2506	27	CD 3474	160
CD 1466/1	203	RD 2508	30	CD 3862	162
CD 1474	159	RD 2508/A	33	CD 3863	163
CD 1474/1	204	RS 2509	30	CD 3864	162
CD 1865	166	RS 2509/A	33	CD 3865	163
CD 1867	167	KT 2509/A	51	TM 4005	211
CD 1868	166	RS 2509/A	52	TM 4012	209
CD 1869	167	RD 2511	29	TM 4014	209
CD 1873	170	RD 2511/A	32	CCBP 4022	243
CD 1877	171	RS 2512	29	CCBAP 4023	249
CD 1878	170	RS 2512/A	32	CCBAP 4024	248
CD 1879	171	MT 2582	83	CCBAP 4025	261
SS 1982	325	MT 2590/A	70	CCBP 4026	260
SS 1984	329	VT 2600	105	CCBAP 4027	261
GS 1993	325	CD 2865	164	CCBP 4032	244
GS 1995	106	CD 2867	165	CCBAP 4033	250
GS 1995	325	CD 2868	164	CCBAP 4034	249
DM 2018	238	CD 2869	165	CCBAP 4035	262
KT 2058/A	62	CD 2873	168	CCBP 4036	260
RD 2058/A	67	CD 2877	169	CCBAP 4037	263
KT 2059/A	61	CD 2878	168	CD 4071	259
RS 2059/A	66	CD 2879	169	CD 4072	259
KT 2069/A	62	TT 3000	38	CCBAP 4079	262
RCD 2069/A	67	TT 3000	71	CCBAP 4080	263
KT 2073/A	63	TT 3002	38	CX 4123	191
RCS 2073/A	67	TE 3010	275	VP 5012	286
TT 2302	38	TE 3011	275		
CD 2446	156	TE 3012	275		
CD 2465	164	TE 3013	275		
CX 2465	188	TE 3020	291		
CX 2465M	192	TS 3030	282		
CD 2466	156	TS 3032	283		
CD 2467	165	TS 3035	283		
CD 2468	164	TS 3037	282		
CX 2468	188	TS 3050	283		
CX 2468M	192	TT 3051	200		
CD 2469	165	TT 3061	200		
CD 2473	168	VA 3090	281		
CX 2473	189	VA 3090S	275		
CX 2473M	193	TE 3110	281		
CD 2474	160	TE 3111	281		
CD 2477	169	TE 3112	281		
CD 2478	168	TE 3113	281		

GENERAL CONDITIONS OF SALE

1 PREMISES - 1.1 The present conditions of sale apply to all supplies of Luxor Spa Products (hereafter "Luxor"). Any general conditions, and in particular the conditions of purchase of the Buyer (hereafter "Customer"), unless expressly accepted in writing by Luxor, shall not bind the latter nor exempt the Customer from the application of the present General Conditions (hereafter GSC)

2. ORDERS - 2.1 The Purchase Orders (referred to as 'Orders') are an irrevocable purchase proposal. By placing an Order, customers fully accept the present General Conditions of Sale.

2.2 Orders are considered accepted only after Luxor confirms them in writing. The Order confirmation and/or Invoice issued by Luxor will be considered as confirmation.

2.3 Any changes to the Order requested by the Customer after the sending of the Order Confirmation will only be valid and enforceable after written acceptance by Luxor. Cancellation or modification of Orders without the prior written consent of Luxor, will give Luxor the right to act to obtain reimbursement of the costs incurred, without prejudice to the right to compensation for greater damages.

3 PRICES - 3.1 Luxor products will be invoiced based on the current price list at the time the order is accepted. Prices do not include VAT or any other taxes.

3.2 Prices listed in sales catalogues/lists are merely indicative and may be subject to change due to production cost increases. In such cases, Luxor will inform the purchaser of the price increase and provide the reasons.

4 DELIVERY TERMS - 4.1 The supplies in each individual Order will be delivered within the stated terms in the Order Confirmation.

4.2 Luxor will not be held responsible for delays in delivery that are not caused by Luxor, such as delays by third parties, including suppliers and sub-suppliers, shippers, and causes of force majeure that result in total or partial inactivity of the plants. In the cases mentioned above, the Customer cannot refuse delivery of the goods, even if it is only partial, nor can they use a delay in delivery as a reason to terminate the contract or claim damages.

5 SHIPMENTS - 5.1 The products will be delivered to the 'Assigned Port' (Incoterms 2020 EXW), with transport costs and risks borne by the buyer, unless otherwise agreed.

5.2 Even in the case of agreed delivery in "Free Port" (Incoterms 2020 DDP) with costs borne by Luxor, the goods will still travel at the buyer's risk. Regardless of the delivery terms agreed upon by the parties, the risks will pass to the buyer at the latest with delivery to the first carrier.

5.3 The transfer of ownership of the goods is suspended until the full price has been paid, but this does not affect the transfer of risk to the purchaser.

5.4 If special packaging is required, an additional charge as indicated in the price list or order confirmation will be added to the invoice.

6 PAYMENTS - 6.1 Payments are due as per the terms and manner specified in the order confirmation and/or invoice.

6.2 Unless otherwise expressly agreed, payments must be made to the bank details mentioned in the sales invoice. For payments made from abroad via bank transfer, the OUR option must be selected to ensure that Luxor receives the net amount on the invoice after deducting bank charges and expenses. Luxor does not authorize any third parties, including agents and representatives, to collect money on its behalf.

6.3 The Customer is not permitted to suspend or delay payments, even in the event of claims or complaints of defects, and must adhere to the agreed terms.

6.4 In case of payment interruption or suspension, the Customer will be considered in default. Luxor reserves the right to charge expenses and interest as per Art. 5 and 6 of D.Lgs n. 192/2012, without prejudice to the right to terminate the contract. Delayed payment may also result in Luxor excluding the guarantee for the entire period of delay.

6.5 If the Customer fails to adhere to the agreed payment terms, or interrupts or suspends payment, Luxor reserves the right to suspend any ongoing supplies and/or make the execution of the current order conditional on the payment of the outstanding debt. Luxor may also withdraw from any further contracts with the Customer and cancel any previously granted favourable conditions, such as discounts or free gifts.

6.6 The Customer is not permitted to offset any claims they may have against Luxor with debts they owe to Luxor, unless formally authorised by Luxor

7 EXPRESS TERMINATION CLAUSE - 7.1 Luxor may terminate the contract immediately if the Customer is undergoing bankruptcy or liquidation proceedings, as well as in the event that the Customer is subject to execution proceedings and/or protests and the economic conditions suggest the purchaser is insolvent.

8 WARRANTY - 8.1 Luxor guarantees the conformity of the products supplied, free from defects that could make them unsuitable for their intended use. The guarantee may be invoked if the defect is due to

manufacturing errors or defects in raw materials that are the responsibility of Luxor.

8.2 Unless otherwise expressly agreed, the guarantee lasts for one (1) year from the date of delivery. The Customer must make a written complaint within eight (8) days from delivery in the case of apparent defects, or, in the case of hidden defects, from the time of discovery and in any event not later than twelve (12) months from delivery.

8.3 In the event of non-conforming products, Luxor may, at its discretion, provide the Buyer with replacement products of the same type and quantity free of charge ex works, after verifying the returned products. Any return must always be previously agreed and authorised by Luxor. The goods in question must be returned 'carriage paid' along with a note explaining the reason for the return within 30 days of Luxor's approval. Failure to do so will result in the authorization becoming invalid.

8.4 If Luxor does not recognize the defective products upon verification, it will invoice those sent as replacements. If Luxor does not recognize the defective products upon verification, they will invoice the replacements. If Luxor is unable to replace defective products, they may issue a credit note to the customer for the value of the defective products. This does not imply any responsibility on Luxor for direct, indirect, or consequential damages resulting from or connected to the defects or faults of the products.

8.5 It is important to note that this guarantee does not cover instances where the product has been installed, used or maintained in a manner that is contrary to the instructions and warnings provided in the installation, use, and maintenance manuals that were included with the product. Additionally, any installation or repair work should only be carried out by qualified personnel.

8.6 The guarantee will not apply if the Purchaser breaches their contractual obligations.

8.7 This warranty is the only warranty and replaces any other written, oral or implied warranties. By accepting these General Terms and Conditions, the Purchaser expressly waives any right of recourse arising from the sale and/or installation of the Products to a non-professional consumer.

9. RESERVATION OF PROPERTY 9.1 The sale of Luxor S.p. A's Products is carried out under reservation of ownership. Therefore the products will remain the property of Luxor S.p.A. until the full payment of the price by the buyer.

10 TRANSFER OF THE CONTRACT 10.1 It is forbidden to transfer the Contract and/or any interest, right and obligation connected to it to third parties without specific written approval by Luxor.

11 PRIVACY - 11.1 The Customer confirms that they have read the information regarding the processing of their personal data, as required by Articles 13 and 14 of Regulation (EU) 2016/679 (GDPR) as amended. The information can be found at <https://luxor.it/privacy-policy>. By accepting these GTC, the Customer consents to the processing of their personal data.

11.2 Luxor will process the personal data provided by the Customer, including through external parties, to fulfil legal obligations and carry out administrative and commercial tasks related to the contractual relationship.

12 APPLICABLE LAW AND COURT OF JURISDICTION - 12.1 Contract is governed by Italian law. Anything not expressly governed by these GVCs shall be governed by the rules on sale provided for in articles 1470 et seq. of the Italian Civil Code.

12.2 The Parties expressly exclude the application of the Vienna Convention on Contracts for the International Sale of Goods. Any disputes related to the Contract, including those regarding its validity, interpretation, execution, and termination, must be referred exclusively to the Court of Brescia.

12.3 Luxor reserves the right to take legal action at the competent court of the Customer's location to recover any outstanding debts. The local law will apply in this case.

13 FINAL CLAUSES - 13.1 The possible nullity and/or ineffectiveness of one or more provisions of these GTC shall not affect the validity of the Contract as a whole.

13.2 Any amendment to the Contract shall be valid only if made in writing and signed by authorised representatives of both Parties.

The customer acknowledges that they are not a 'consumer' and therefore the provisions of law relating to relations between entrepreneurs and consumers do not apply. The customer declares that they have paid particular attention to the following clauses: Introduction (1.1), Orders (2.1-2.3), Prices (3.2), Delivery Terms (4.1-4.2), Shipping (5.1-5.3), and 6. The following sections require approval: Payments (6.2 - 6.3 - 6.4 - 6.5 - 6.6); 7 Express Termination Clause (7.1); 8 Warranty (8.1 - 8.2 - 8.3 - 8.4 - 8.5 - 8.6 - 8.7); 9. Retention of Title (9.1); 10. Applicable Law and Jurisdiction (12.1 - 12.2 - 12.3); 13 Final Clauses (13.1 - 13.2), and they are to be specifically approved.

These general terms and conditions are published on LUXOR's website (<https://luxor.it/>) where they may be consulted, thereby taking full and proper cognisance thereof, pursuant to and for the purposes of Articles 1341 and 1342 of the Civil Code.

CATALOGUE VALIDITY

The information in this publication is correct at the time of going to press.

Luxor SpA, reserves the right to alter specifications and operating parameters for all the illustrated products at any time as part of their policy of continuous product development.



LUXOR SPA

LEGAL OFFICE: Via Zanardelli, 88 - 25013 Carpenedolo (BS) Italy

ADMINISTRATIVE OFFICE, FACTORY AND COMMERCIAL OFFICE:

Via Madonnina, 94 - 25018 Montichiari (BS) Italy

Tel. +39 030 9961161 - Fax +39 030 9961165 - info@luxor.it

www.luxor.it