

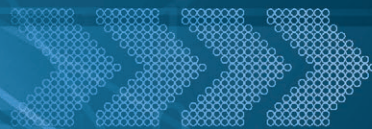

LUXOR®



**CATALOGO GENERALE
LINEA IDROSANITARIA**

2024.1



60 ANNI DI TRADIZIONE ITALIANA

Luxor è una importante realtà industriale, market leader a livello europeo e mondiale nella produzione di tubi flessibili e di componenti per impianti idraulici e termosanitari.

Da sessant'anni Luxor è espressione del più prestigioso made in Italy e della grande tradizione italiana nelle lavorazioni meccaniche ad elevato contenuto tecnologico: una qualità certificata e riconosciuta dai più prestigiosi Istituti Internazionali di certificazione, ovunque nel mondo.

La nostra mission è la completa soddisfazione del cliente, mediante un processo di continua ricerca tecnologica volta a realizzare prodotti di assoluta qualità e totale affidabilità, anticipando le evoluzioni dei mercati all'interno di un innovativo rapporto di partnership sia verso i

clienti che verso i fornitori. La mission Luxor trova attuazione in un proprio Centro Ricerca & Sviluppo, nel quale vengono costantemente analizzate e ricercate nuove ed avanzate tecnologie, in continui investimenti per offrire ai mercati internazionali le soluzioni più avanzate ed affidabili a costi contenuti, nei più severi controlli qualitativi su ogni pezzo.

Luxor progetta e realizza globalmente, grazie al proprio ultra decennale know-how, ogni prodotto. La grande forza produttiva, un'organizzazione industriale "snella" innovativa ed avanzata, unitamente ad una moderna concezione logistica permettono a Luxor di soddisfare qualsiasi esigenza, anche customized, con consegne rapide in ogni parte del mondo.



Luxor S.p.A. è certificata ISO 9001:2015 dall'istituto di certificazione DEKRA Group

CERTIFICAZIONI



Per informazioni sulle specifiche tecniche e sui prodotti certificati si prega di rivolgersi ai nostri uffici o visitare il sito web degli enti di certificazione corrispondenti.

La lista completa dei prodotti certificati NSF è consultabile al sito www.nsf.org.

La lista completa dei prodotti certificati UPC/cUPC è consultabile al sito www.iapmort.org.

1 TUBI FLESSIBILI BAGNO

**1.1 / FLEXY MIX**
DN 8 EPDM miscelatore

351

**1.2 / FLEXY MIX PT+**
DN 8 Silicone miscelatore

355

**1.3 / OMNYFLEX 8**
DN 8 EPDM generico

359

**1.4 / OMNYFLEX PT+**
DN 8 Silicone generico

369

**1.5 / OMNYFLEX 10**
DN 10 EPDM generico

375

**1.6 / W-FLEX**
DN 8-10 EPDM doccia /
idromassaggio

385

**1.7 / SHOWER FLEX**
DN 10 PVC doccia

389

**1.8 / OMNYFLEX 13**
DN 13 EPDM generico

393

2 TUBI FLESSIBILI CUCINA

**2.1 / K-FLEX**
DN8 EPDM doccetta cucina

399

**2.2 / FLEXY MIX**
DN 8 EPDM miscelatore

403

**2.3 / FLEXY MIX PT+**
DN 8 Silicone miscelatore

407

3 TUBI FLESSIBILI CARICO ELETTRODOMESTICI

**3.1 / E-FLEX INOX**
DN 8-10-13 con treccia

411

**3.2 / E-FLEX**
DN 10 senza treccia

415

4 TUBI FLESSIBILI INDUSTRIALI

**4.1 / ACFZ-S**
DN 15-50 acciaio zincato

419

**4.2 / ACFZ-B**
DN 15-50 raccordi ottone

427

**4.3 / ACFX**
DN 15-50 acciaio inox

435

**4.4 / ACEX**
DN 15 - 25 estensibile

443

Tubi flessibili:
istruzioni di installazione

444





Tubi flessibili:
istruzioni di manutenzione

446

Tubi flessibili:
istruzioni di lunghezza

446

5 COLLEGAMENTI RIGIDI SOTTOLAVABO

	Istruzioni di installazione	449		Tubetti rame cromato	450		Squadrette sottolavabo	453
	Raccordi a compressione	456		Rosette	457			



6 RUBINETTI

	6.1 / STARX Rubinetti a vitone con filtro	463		6.2 / DELTAX Rubinetti a vitone senza filtro	469		6.3 / SPHERALUX Rubinetti sottolavabo a sfera	473
	6.4 / SERIE 50th Rubinetti sottolavabo d'arredo	479		6.5 / SERIE SC Rubinetti per cassetta scarico	483		6.6 / SERIE K Rubinetti per elettrodomestici	487
	6.7 / SERIE G Rubinetti a galleggiante	492		6.8 / ACCESSORI	496			

7 SIFONI

	7.1 / SERIE ST Sifoni standard	503		7.2 / SERIE PREMIUM Sifoni di lusso	507		7.3 / SERIE PL Sifoni in ABS	511
	7.4 / SERIE 50th Sifoni d'arredo	515		7.5 / SERIE K Sifoni per elettrodomestici	518		7.6 / TUBI DI SCARICO E ACCESSORI	520

8 ACCESSORI

	Pilette	529		Accessori	531
---	---------	-----	---	-----------	-----



LUXOR[®]

TUBI FLESSIBILI

TUBI FLESSIBILI



I tubi flessibili Luxor Spa sono prodotti di assoluta qualità Made in Italy, qualità e affidabilità riconosciuta ed apprezzata in tutto il mondo.

Le loro ottime caratteristiche igieniche e meccaniche e la praticità di installazione trovano sempre maggiore interesse da parte di fabbricanti, installatori e commercianti.

L'attenzione costante alle richieste del mercato, alle esigenze dei clienti e ai requisiti igienici e ambientali fanno dei tubi flessibili Luxor un chiaro punto di riferimento nel mercato idrosanitario.



QUALITÀ E CONFORMITÀ

Sistema di gestione della Qualità approvato dai più importanti Istituti di Certificazione Internazionali.



RISPETTO DELLA NORMA EN 13618

I tubi flessibili conformi alla norma EN 13618 sono disponibili nelle dimensioni DN 6 al DN 25 e costituiscono la scelta ottimale per condurre acque potabili e sanitarie in qualsiasi tipo di installazione.



PARCO MACCHINE AUTOMATICHE

Il processo produttivo si avvale di macchinari all'avanguardia, garantendo un'esecuzione precisa del prodotto attraverso tutte le fasi del processo.



PROGETTAZIONE A 360°

Luxor gestisce internamente l'intero processo di produzione dei tubi flessibili, dalla progettazione all'assemblaggio, assicurando un controllo totale sulla qualità e sull'efficienza dei propri prodotti.



SOLUZIONI PERSONALIZZATE

Luxor collabora sinergicamente con i suoi clienti per produrre tubi flessibili personalizzati, sviluppando prodotti su misura che soddisfano le esigenze del mercato.



PROCEDURE DI CONTROLLO

I tubi flessibili Luxor sono sottoposti a rigorose procedure di controllo che impiegano telecamere ad alta risoluzione per individuare eventuali difetti, garantendo un'accurata verifica della qualità del prodotto.



RACCORDI SU MISURA

Luxor realizza raccordi personalizzati e offre servizi di progettazione su misura e soluzioni ad hoc per i suoi clienti.



MARCATURA

Tutti i tubi flessibili Luxor sono contrassegnati da una marcatura sulle bussole di serraggio indicanti marchio LUX, anno di produzione e riferimenti tecnico-normativi. Con la marcatura ogni fabbricante si assume la responsabilità di ciò che produce:
diffidate dei tubi anonimi!

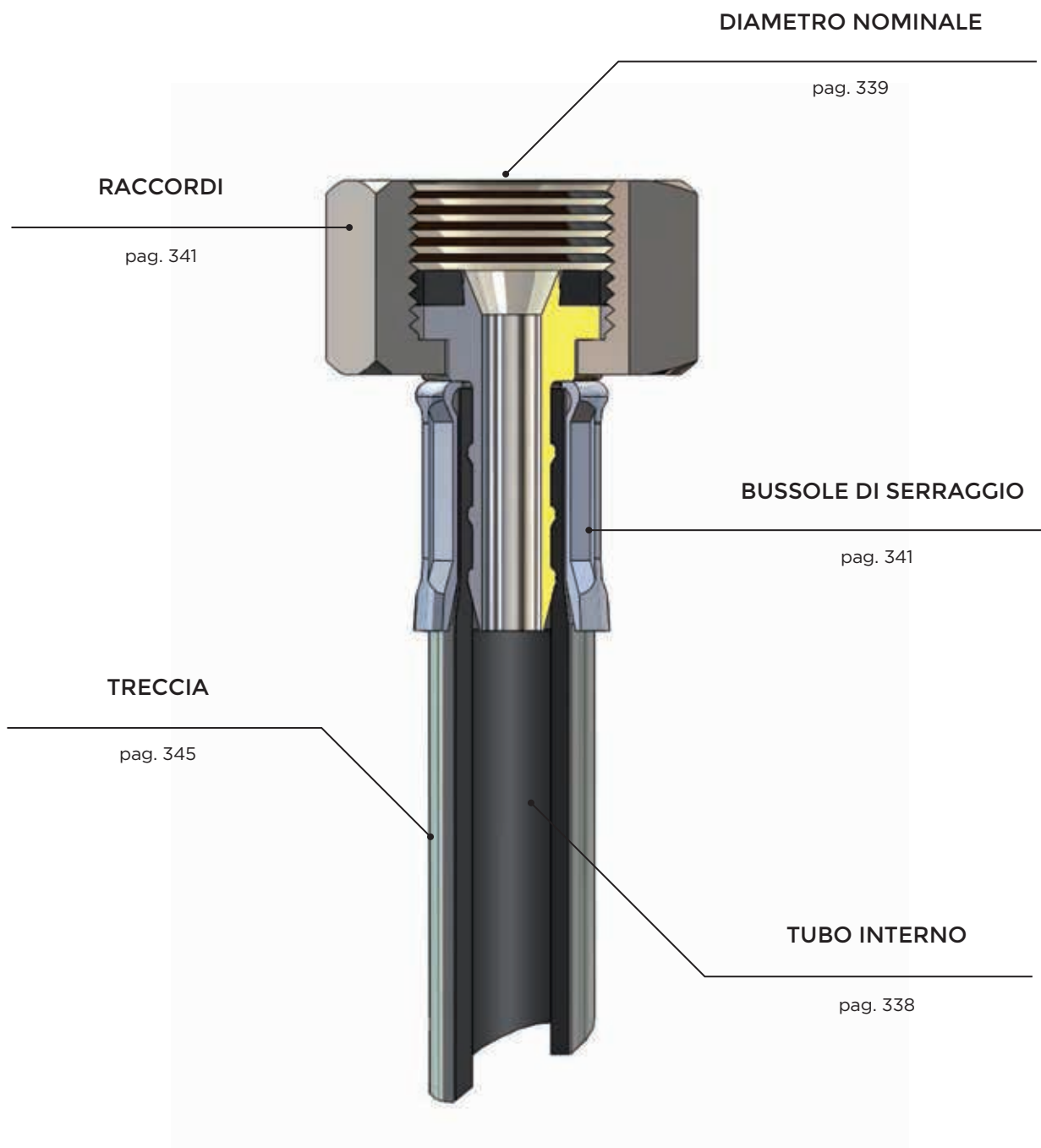

**CAMPI DI
APPLICAZIONE**

pag. 336

**CERTIFICAZIONI
DI PRODOTTO**

pag. 346

ISTRUZIONI DI INSTALLAZIONE

pag. 444

ISTRUZIONI DI LUNGHEZZA

pag. 446

CAMPI DI APPLICAZIONE

I tubi flessibili Luxor sono la soluzione ideale per ogni tipo di applicazione, sia che si tratti di conduzione di acqua potabile che di installazioni industriali.

I tubi flessibili Luxor sono sicuri e facili da installare. Sotto riportati in tabella solo alcuni dei più comuni campi di applicazione e la loro disponibilità con gli inliner Silicone, Termoplastico, EPDM, PEX e Butile.

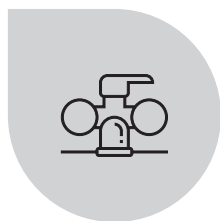

rubinetto tradizionale



rubinetti miscelatori



impianti di riscaldamento



cassette di scarico

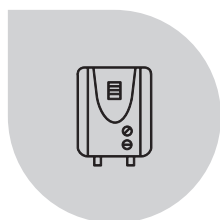

caldaie

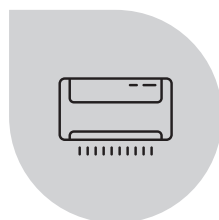

doccetta cucina

impianti
condizionamento / fan coil

lavatrici



colonne montanti

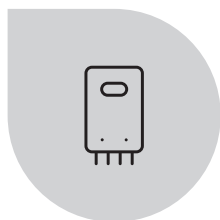

scaldabagni



lavastoviglie



cabine doccia



vasche idromassaggio



pompe

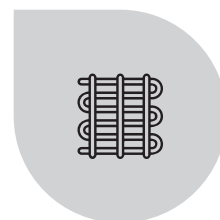

macchine da caffè

pannelli radianti
a soffitto

Gamma Tubo Interno																									
Diametro Nominale		Rubinetto monocomando	Rubinetto tradizionali	Rubinetto miscelatori	Rub. misc. con doccetta estraibile	Rubinetto monoforo	Macchine da caffè	Cassette di scarico	Installazioni idrauliche	Installazioni sanitarie	Scaldabagni	Tubi carico	Contatori acqua	Vasche idromassaggio	Cabine doccia	Fan-coil	Impianti riscaldamento	Pompe	Autoclavi	Pompe di calore	Impianti condizionamento	Serre	Colonne montanti	Installazioni idrauliche generiche	Pannelli radianti a soffitto
	DN6	●		●			●																		
	DN8	●	●	●	●	●	●	●	●	●	●					●	●				●				●
	DN10		●						●	●	●	●				●	●				●				●
	DN13								●		●	●	●	●	●	●	●				●				●
	DN15										●						●	●	●	●	●	●	●	●	●
	DN18																●	●	●	●	●	●	●	●	●
	DN25																●	●	●	●	●	●	●	●	●
	DN32																●	●	●		●	●	●	●	●
	DN40																●	●	●			●	●	●	●
	DN50																●	●	●			●	●	●	●

TUBO INTERNO

SILICONE

Il silicone platinico, materiale pregiato di altissima qualità, sta raccogliendo sempre più consenso sui mercati idrosanitari internazionali. Questa è la versione più pura disponibile sul mercato e capace di garantire la piena alimentarietà del prodotto. Alcune delle caratteristiche peculiari sono il mantenimento di un'ottima elasticità e delle proprietà meccaniche per tutto il range di temperatura di servizio.

- ✓ PUREZZA IGIENICA
- ✓ RESISTENZA ALTE TEMPERATURE



TERMOPLASTICO

Frutto di anni di ricerca e sviluppo dei materiali più nobili e performanti, la nuova linea di tubi flessibili Luxor in materiale termoplastico coniuga l'assoluta purezza e l'igiene del Pex e del Silicone e con le grandi proprietà meccaniche dei tubi flessibili in EPDM. La flessibilità, la versatilità, la completezza della gamma di utilizzo fanno dei tubi flessibili in termoplastico Luxor un prodotto di alta qualità riconosciuta in tutto il mondo e certificata dai più importanti Istituti di Certificazione di prodotto. I tubi flessibili in termoplastico Luxor sono stati progettati per rispettare la salute dei consumatori e l'ambiente che ci circonda: igienicamente puri e completamente riciclabili.

- ✓ OMOLOGAZIONI
- ✓ FLESSIBILITÀ



EPDM

La gomma EPDM perossidica è il materiale più utilizzato per la realizzazione del tubo interno. Con diverse composizioni chimiche, ha proprietà igieniche e meccaniche di alto livello, unitamente ad un'assoluta resistenza all'ossidazione, agli agenti atmosferici ed alle alte temperature.

- ✓ RESISTENZA MECCANICA
- ✓ COMPLETEZZA GAMMA

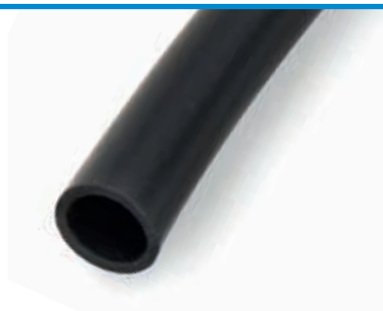

PEX

Il PEX è un materiale termoplastico dalle alte qualità igieniche che mantiene inalterati sapori ed odori dell'acqua di contatto per tutto il range di temperatura. I flessibili prodotti con questo materiale si sono affermati sul mercato idrosanitario come valida alternativa al tubo flessibile in EPDM.

- ✓ BUONA PUREZZA IGIENICA



BUTILE

Il butile è un materiale con bassa permeabilità all'ossigeno, questa sua caratteristica lo rende idoneo a tutte le applicazioni a circuito chiuso dove l'ossigeno crea corrosione.

- ✓ RESISTENZA ALLA PERMEABILITÀ DELL'OSSIGENO





DIAMETRO NOMINALE

La gamma dei tubi flessibili Luxor Spa comprende prodotti in conformità alle più importanti normative di prodotti internazionali e alla recente normativa europea EN13618:2017. Sotto riportata la tabella delle caratteristiche tecniche principali per ogni diametro nominale e la loro disponibilità con gli inliner Silicone, Termoplastico, Epdm, Pex e Butile.

Gamma Tubo Interno	Diametro Nominale	∅ Interno mm	∅ Esterno mm	Raggio min. curvatura mm	∅ Interno raccordi mm	Portata a 3 bar	Pressione max esercizi	Temperatura max esercizio	Temperatura min esercizio	Raccordi disponibili	Treccia disponibile	Materiale bussole di serraggio
												
	DN6	6,3	10	40	4,7	16 l/min	10 Bar	70° C	-5° C	Ottone, acciaio inox, plastica	Acciaio inox Nylon PA 6.6	Acciaio inox
	DN8	8,5	12	48	6,2	28 l/min	10 Bar	70° C	-5° C	Ottone, acciaio inox, plastica	Acciaio inox Nylon PA 6.6	Acciaio inox
	DN8	8,5	12,3	48	6,2	28 l/min	10 Bar	90° C	-20° C	Ottone	Acciaio inox	Acciaio inox
	DN10	9,4	13	56	7,5	46 l/min	10 Bar	70° C	-5° C	Ottone, rame, acciaio inox, plastica	Acciaio inox Nylon PA 6.6	Acciaio inox
	DN10	9,4	13,7	56	7,5	46 l/min	10 Bar	90° C	-20° C	Ottone	Acciaio inox	Acciaio inox
	DN13	12,5	18	72	10	74 l/min	10 Bar	70° C	-5° C	Ottone, rame, acciaio inox, plastica	Acciaio inox Nylon PA 6.6	Acciaio inox
	DN13	12,5	17,8	72	10	74 l/min	10 Bar	90° C	-20° C	Ottone	Acciaio inox	Acciaio inox
	DN15	15	20	80	12,5	83 l/min	10 Bar	110° C	-5° C	Ottone, rame, acciaio inox, acciaio zincato	Acciaio inox, acciaio zincato	Acciaio inox
	DN15	15	19,8	80	12,5	83 l/min	10 Bar	90° C	-20° C	Ottone	Acciaio inox	Acciaio inox
	DN18	19	26	104	15,5	200 l/min	10 Bar	110° C	-5° C	Ottone, rame, acciaio inox, acciaio zincato	Acciaio inox, acciaio zincato	Acciaio inox, alluminio
	DN18	19	25,7	104	15,5	200 l/min	10 Bar	90° C	-20° C	Ottone	Acciaio inox	Acciaio inox
	DN25	25,5	33	132	21	280 l/min	10 Bar	110° C	-5° C	Ottone, rame, acciaio inox, acciaio zincato	Acciaio inox, acciaio zincato	Acciaio inox, alluminio
	DN25	25,5	32,8	132	21	280 l/min	10 Bar	90° C	-20° C	Ottone	Acciaio inox	Acciaio inox
	DN32	32	42	168	27	490 l/min	6 Bar	110° C	-5° C	Ottone, acciaio inox, acciaio zincato	Acciaio inox, acciaio zincato	Acciaio inox, alluminio
	DN32	32	41,6	168	27	490 l/min	6 Bar	90° C	-20° C	Ottone	Acciaio inox	Acciaio inox
	DN40	40	53	212	32	800 l/min	6 Bar	110° C	-5° C	Ottone, acciaio inox, acciaio zincato	Acciaio inox, acciaio zincato	Alluminio
	DN50	50	65	275	41	1300 l/min	6 Bar	110° C	-5° C	Ottone, acciaio inox, acciaio zincato	Acciaio inox, acciaio zincato	Alluminio

 Silicone  EPDM  Termoplastico  PEX  Butile

Per ulteriori informazioni si prega di contattare il nostro ufficio tecnico

DIAGRAMMI DI PORTATA

Diagrammi di portata ottenuti su tubi flessibili con raccordi dritti e lunghezza di 1400 mm.

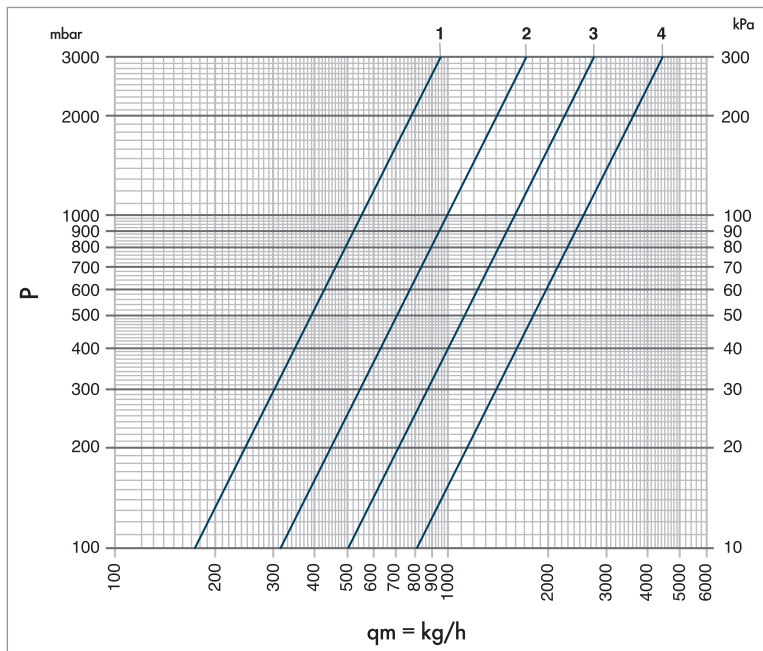

DIMENSIONI TUBO	POS	Kv	Portata in l/min con ΔP 3 bar
DN 6	1	0,55	16
DN 8	2	0,97	28
DN 10	3	1,59	46
DN 13	4	2,56	74

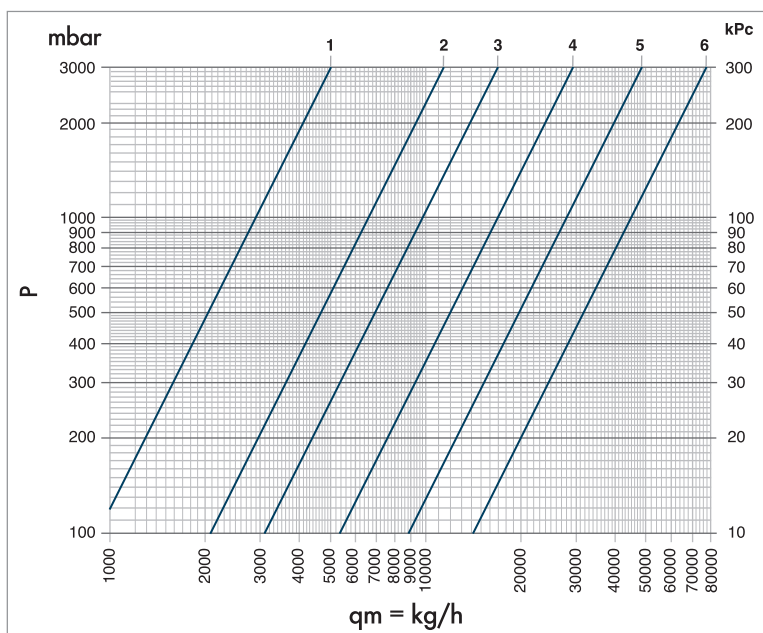

DIMENSIONI TUBO	POS	Kv	Portata in l/min con ΔP 3 bar
DN 15	1	2,9	83
DN 18	2	6,6	200
DN 25	3	9,8	280
DN 30	4	17	490
DN 40	5	28	800
DN 50	6	45	1300

RACCORDI



MATERIALI

CW617N E CW614N

Il principale materiale utilizzato per realizzare i raccordi di collegamento, a basso contenuto di piombo e in conformità alle più recenti normative UNI EN12165 e UNI EN12164.

CW602N, CW724R, CW511L

Si distingue dall'ottone comunemente utilizzato in quanto evita il fenomeno della dezincificazione (corrosione causata dalla perdita dello zinco e dal conseguente rideposito del rame).

CW724R, CW511L, CW510L

Con l'obiettivo di migliorare le caratteristiche igieniche dei prodotti ed elevare sempre più la purezza di materiali, Luxor utilizza per particolari mercati ottoni con percentuale di piombo minima (<0.2%).

ACCIAIO INOX AISI304

Dove sono necessarie alte resistenze all'ossidazione e ottima resistenza a sollecitazioni meccaniche.

RAME DISSODIATO AL FOSFORO

Qualità Cu-DHP con composizione chimica Cu 99,9% min, le cui caratteristiche meccaniche, le dimensioni e le tolleranze sono rispondenti alla norma EN1057.

ACCIAIO AVP

Sono inoltre disponibili, su particolari richieste raccordi in acciaio AVP.



GUARNIZIONI E O-RING

La tenuta idraulica dei raccordi è garantita dall'utilizzo di Guarnizioni e o-ring in EPDM e NBR, materiali ad alta proprietà antiozono, che preservano le loro caratteristiche di tenuta e di resistenza meccanica nel tempo.

Le mescole utilizzate, grazie alle loro ottime proprietà igieniche, sono idonee all'adduzione di acqua potabile e sono state approvate dai più severi enti di certificazione di prodotto del settore idrosanitario.

Le caratteristiche meccaniche, fisiche e igieniche delle guarnizioni e degli o-ring vengono appurate attentamente eseguendo specifici test di laboratorio interni e esterni per verificare la rispondenza alle norme previste.



LA SFIDA

Sebbene le percentuali di piombo all'interno delle leghe in ottone per i raccordi siano basse e garantite da norme europee, la nuova sfida che si pone ai produttori di materiale idraulico è l'eliminazione totale del piombo dagli articoli realizzati.



LAVORAZIONI

I raccordi, in base alle specifiche richieste del mercato o da quanto previsto dalle certificazioni di prodotto, vengono poi sottoposti a ulteriori processi di lavorazione come il trattamento di normalizzazione (per distendere il materiale, ridurre la durezza superficiale ed evitare la formazione di cricche di lavorazione).

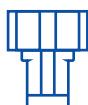

BUSSOLE DI SERRAGGIO

La bussole di serraggio dei raccordi vengono realizzate in acciaio inox AISI 304 (dal DN6 al DN50) e in alluminio (dal DN15 al DN50), materiali sicuri che a differenza dell'ottone non sono soggetti alle rotture da tensocorrosione.

TIPOLOGIA DI RACCORDI

Soddisfare le esigenze del cliente nella fase di progettazione dei prodotti e proporre nuove soluzioni tecniche sono obiettivi primari della Luxor Spa.

Gamma Tubo Interno	Diametro Nominale								
<ul style="list-style-type: none"> ● Silicone ● EPDM ● Termoplastico ● PEX 	DN6	Maschio corto M 8x1 - 18 mm M 10x1 - 18 mm M 11x1 - 20 mm		Maschio medio M 8x1 - 44 mm M 10x1 - 44 mm		Maschio Lungo M 8x1 - 74 mm M 10x1 - 74 mm		Astina Liscia ø 10 mm	
		Astina Scalino ø 8 mm ø 10 mm		Femmina senza guarnizione G 1/4 - G 3/8 - G 1/8 G 1/2 - M 10x1 M 15x1 M 12x1 - 9/16 - 24 unef		Ghiera G 1/2		Maschio G 1/8 G 3/8 G 1/2	
		Maschi Girevoli M 12x1 M 15x1 G 3/8		Femmina con guarnizione G 3/8 - G 1/2 M 10x1 - M 15x1 9/16 - 24 unef					

Gamma Tubo Interno	Diametro Nominale								
<ul style="list-style-type: none"> ● Silicone ● EPDM ● Termoplastico ● Butile 	DN8	Maschio corto M 10x1 - 18 mm M 11x1 - 19 mm M 12x1 - 19 mm		Maschio medio M 10x1 - 46 mm M 12x1 - 43 mm		Maschio Lungo M 10x1 - 74 mm M 12x1 - 75 mm		Astina Liscia ø 10 mm ø 15 mm	
		Astina Scalino ø 10 mm		Maschio G 1/4 G 3/8 G 1/2 G 3/4		Femmina senza guarnizione G 1/4 - G 3/8 - G 1/2 G 3/4 - M 15x1		Femmina Curva senza guarnizione G 1/4 - G 3/8 G 1/2 - G 3/4	
		Raccordo a Stringere ø 10 mm ø 12 mm ø 14 mm ø 15 mm		Maschi Girevoli M 15x1 G 3/8 G 1/2		Ghiera G 1/2		Femmina con o-ring G 3/8	
		Femmina Curva con o-ring G 3/8		Femmina con guarnizione G 3/8 - G 1/2 G 3/4 - 1/2 NPSM 9/16 - 24 unef		Femmina Curva con guarnizione G 3/8 - G 1/2 G 3/4		Maschio Prolungato G 3/8 - 26 mm G 1/2 - 28 mm	
		Push-Fit Ottone ø 10 mm							

● Silicone
 ● EPDM
 ● Termoplastico
 ● PEX
 ● Butile

Per ulteriori informazioni si prega di contattare il nostro ufficio tecnico

Gamma Tubo Interno	Diametro Nominale						
<ul style="list-style-type: none"> ● EPDM ● Termoplastico ● Butile 	DN10	Maschio corto M 12x1 - 16 mm 	Maschio G 1/4 G 3/8 G 1/2 	Femmina senza guarnizione G 3/8 G 1/2 G 3/4 	Femmina Curva senza guarnizione G 3/8 G 1/2 G 3/4 		
		Raccordo a Stringere ø 10 mm ø 12 mm ø 14 mm ø 15 mm 	Femmina Alettata con e senza o-ring G 1/2 	Maschi Girevoli G 3/8 G 1/2 	Push-Fit Ottone ø 12 		
		Femmina con guarnizione G 3/8 - G 1/2 G 3/4 	Femmina Curva con guarnizione G 1/2 - G 3/4 	Maschio Prolungato G 3/8 - 26 mm G 1/2 - 28 mm 			

Gamma Tubo Interno	Diametro Nominale						
<ul style="list-style-type: none"> ● Silicene ● EPDM ● Termoplastico ● Butile 	DN13	Maschio G 3/8 G 1/2 G 3/4 	Femmina senza guarnizione G 3/8 G 1/2 G 3/4 	Femmina Curva senza guarnizione G 1/2 G 3/4 G 1" 	Astina Liscia ø 15 mm 		
		Astina Scalino ø 15 mm 	Raccordo a Stringere ø 12 mm ø 15 mm 	Push-Fit Ottone ø 12 	Femmina con guarnizione G 1/2 - G 3/4 		
		Femmina Curva con guarnizione G 1/2 - G 3/4 	Maschio Prolungato G 1/2 - 28 mm 				

Gamma Tubo Interno	Diametro Nominale						
<ul style="list-style-type: none"> ● EPDM ● Butile 	DN15	Maschio G 1/2 G 3/4 	Femmina G 1/2 G 3/4 	Femmina Curva G 1/2 G 3/4 	Astina Liscia ø 15 mm 		

Gamma Tubo Interno	Diametro Nominale								
<ul style="list-style-type: none"> ● Silicone ● EPDM ● Butile 	DN18	Maschio G 3/4 G 1"		Femmina G 3/4 G 1"		Femmina Curva G 3/4 G 1"		Astina Liscia ø 22 mm	

Gamma Tubo Interno	Diametro Nominale								
<ul style="list-style-type: none"> ● Silicone ● EPDM ● Butile 	DN25	Maschio G 1"		Femmina G 1" G 1" 1/4 G 1" 1/2		Femmina Curva G 1"		Astina Liscia ø 28 mm	

Gamma Tubo Interno	Diametro Nominale						
<ul style="list-style-type: none"> ● Silicone ● EPDM ● Butile 	DN32	Maschio G 1" 1/4		Femmina G 1" 1/4		Femmina Curva G 1" 1/4	

Gamma Tubo Interno	Diametro Nominale				
<ul style="list-style-type: none"> ● EPDM 	DN40	Maschio G 1" 1/2		Femmina G 1" 1/2	

Gamma Tubo Interno	Diametro Nominale				
<ul style="list-style-type: none"> ● EPDM 	DN50	Maschio G 2"		Femmina G 2"	

TRECCIA

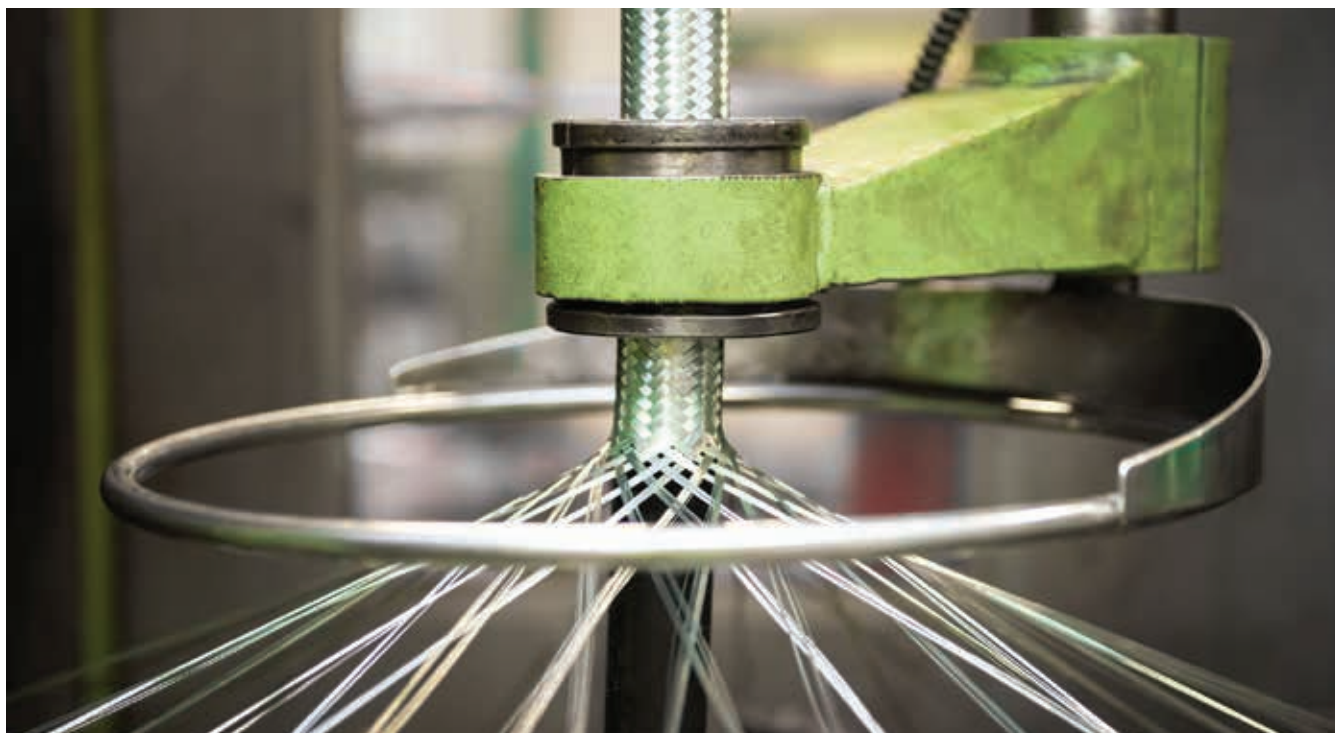

MATERIALI

FILI DI ACCIAIO INOX AISI 304

La treccia esterna di rinforzo viene realizzata utilizzando fili di acciaio inox AISI 304 \varnothing 0,20 mm, \varnothing 0,22 mm, fili in acciaio zincato \varnothing 0,30 mm e fili in Nylon PA 6.6 \varnothing 0,25 mm e \varnothing 0,30 mm.

Questi fili, trasformati in bandelle e assemblati a totale copertura del tubo interno garantiscono al flessibile di sopportare le normali pressioni di esercizio e le eventuali sovrappressioni che si possono generare durante il normale funzionamento di un impianto idraulico.

FILI IN ACCIAIO

I fili in acciaio hanno un diametro minimo di \varnothing 0,20 mm, una dimensione superiore a quella che solitamente viene utilizzata da altri produttori, a garanzia di un prodotto sicuro e affidabile, un prodotto di qualità superiore. L'ottimo materiale di rivestimento ha permesso ai tubi flessibili Luxor di superare i più severi test meccanici richiesti dagli Istituti di Certificazione europei ed extraeuropei del settore idrosanitario.

FILI IN NYLON

Anche i fili in Nylon PA 6.6 assicurano un'ottima resistenza e buone caratteristiche meccaniche grazie all'elasticità del materiale e all'eccellente comportamento ad alte e basse temperature. I tubi flessibili con trecciatura in Nylon PA 6.6 hanno trovato larga diffusione ad esempio tra i miscelatori da cucina con doccetta estraibile grazie alla loro resistenza all'usura da sfregamento e alla bassa rumorosità prodotta durante l'utilizzo quotidiano.

RICOPERTURA

La percentuale di ricopertura può variare in base a quanto previsto dalle certificazioni di prodotto e alle richieste del cliente, si parte da una ricopertura al 97% fino ad arrivare ad una ricopertura all'80%.

La ricopertura al 97% riveste perfettamente il tubo interno rendendo il flessibile meccanicamente più resistente alle sollecitazioni e offrendo un aspetto estetico nettamente superiore.

Le dimensioni del filo, la qualità del materiale e la percentuale di ricopertura distinguono i tubi flessibili Luxor, prodotti di alto profilo qualitativo, da quelli di altri produttori.

CERTIFICAZIONI DI PRODOTTO

Diametro Nominale

DN6	 Nazione: Italia Certificazione: DM 174 Tubo Interno:	 Nazione: Australia Certificazione: WATERMARK Tubo Interno:	 Nazione: Danimarca Certificazione: VA Tubo Interno:
	 Nazione: Francia Certificazione: QB Tubo Interno:	 Nazione: Germania Certificazione: DVGW Tubo Interno:	 Nazione: Norvegia Certificazione: SINTEF Tubo Interno:
	 Nazione: Olanda Certificazione: KIWA Tubo Interno:	 Nazione: Svizzera Certificazione: SVGW Tubo Interno:	 Nazione: Svezia Certificazione: RISE Tubo Interno:
	 Nazione: U.S.A. Certificazione: NSF - IAPMO Tubo Interno: (NSF - IAPMO) (NSF)	 Nazione: UE Certificazione: EN 13618 Tubo Interno:	 Nazione: UK Certificazione: WRAS Tubo Interno:

Diametro Nominale

DN8	 Nazione: Italia Certificazione: DM 174 Tubo Interno:	 Nazione: Australia Certificazione: WATERMARK Tubo Interno:	 Nazione: Danimarca Certificazione: VA Tubo Interno:
	 Nazione: Francia Certificazione: QB Tubo Interno:	 Nazione: Germania Certificazione: DVGW - TÜV Tubo Interno: (DVGW - TÜV) (DVGW)	 Nazione: Norvegia Certificazione: SINTEF Tubo Interno:
	 Nazione: Olanda Certificazione: KIWA Tubo Interno:	 Nazione: Svizzera Certificazione: SVGW Tubo Interno:	 Nazione: Svezia Certificazione: RISE Tubo Interno:
	 Nazione: U.S.A. Certificazione: NSF - IAPMO Tubo Interno:	 Nazione: UE Certificazione: EN 13618 Tubo Interno:	 Nazione: UK Certificazione: WRAS Tubo Interno:

Silicone
 EPDM
 Termoplastico
 PEX

Per informazioni sulle specifiche tecniche e sui prodotti certificati si prega di rivolgersi ai nostri uffici o visitare il sito web degli enti di certificazione corrispondenti. La lista completa dei prodotti certificati NSF è consultabile al sito www.nsf.org. La lista completa dei prodotti certificati UPC/CUPC è consultabile al sito www.iapmort.org.

Diametro
Nominale

DN10	 Nazione: Italia Certificazione: DM 174 Tubo Interno: ●●	 Nazione: Australia Certificazione: WATERMARK Tubo Interno: ●●	 Nazione: Danimarca Certificazione: VA Tubo Interno: ●
	 Nazione: Francia Certificazione: QB Tubo Interno: ●●	 Nazione: Germania Certificazione: DVGW - TÜV Tubo Interno: ● (TÜV) ● (DVGW)	 Nazione: Norvegia Certificazione: SINTEF Tubo Interno: ●
	 Nazione: Olanda Certificazione: KIWA Tubo Interno: ●	 Nazione: Svizzera Certificazione: SVGW Tubo Interno: ●	 Nazione: Svezia Certificazione: RISE Tubo Interno: ●
	 Nazione: U.S.A. Certificazione: NSF - IAPMO Tubo Interno: ●●	 Nazione: UE Certificazione: EN 13618 Tubo Interno: ●●	 Nazione: UK Certificazione: WRAS Tubo Interno: ●●

Diametro
Nominale

DN13	 Nazione: Italia Certificazione: DM 174 Tubo Interno: ●●●●	 Nazione: Australia Certificazione: WATERMARK Tubo Interno: ●●●●	 Nazione: Danimarca Certificazione: VA Tubo Interno: ●●
	 Nazione: Francia Certificazione: QB Tubo Interno: ●●●●	 Nazione: Germania Certificazione: DVGW - TÜV Tubo Interno: ● (DVGW - TÜV) ● (TÜV) ● (DVGW)	 Nazione: Norvegia Certificazione: SINTEF Tubo Interno: ●●
	 Nazione: Olanda Certificazione: KIWA Tubo Interno: ●●	 Nazione: Svizzera Certificazione: SVGW Tubo Interno: ●●	 Nazione: Svezia Certificazione: RISE Tubo Interno: ●●
	 Nazione: U.S.A. Certificazione: NSF - IAPMO Tubo Interno: ●●●●	 Nazione: UE Certificazione: EN 13618 Tubo Interno: ●●●●	 Nazione: UK Certificazione: WRAS Tubo Interno: ●●●●

















● Silicene ● EPDM ● Termoplastico ● PEX

Per informazioni sulle specifiche tecniche e sui prodotti certificati si prega di rivolgersi ai nostri uffici o visitare il sito web degli enti di certificazione corrispondenti. La lista completa dei prodotti certificati NSF è consultabile al sito www.nsf.org. La lista completa dei prodotti certificati UPC/CUPC è consultabile al sito www.iapm.org.



Diametro
Nominale

DN15		Nazione: Francia 		Nazione: Germania 	EN 13618 	
		Certificazione: QB		Certificazione: TÜV		Certificazione: EN 13618
		Tubo Interno: 		Tubo Interno: 		Tubo Interno: 







Diametro
Nominale

DN18		Nazione: Francia 		Nazione: Germania 	EN 13618 	
		Certificazione: QB		Certificazione: DVGW - TÜV		Certificazione: EN 13618
		Tubo Interno: 		Tubo Interno:  		Tubo Interno:  
		Nazione: UK 		Nazione: Germania 		
		Certificazione: WRAS		Certificazione: EN 13618		
		Tubo Interno: 		Tubo Interno:  		





Diametro
Nominale

DN25		Nazione: Francia 		Nazione: Germania 	EN 13618 	
		Certificazione: QB		Certificazione: DVGW - TÜV		Certificazione: EN 13618
		Tubo Interno: 		Tubo Interno:  		Tubo Interno:  



Diametro
Nominale

DN32		Nazione: Francia 		Nazione: Germania 
		Certificazione: QB		Certificazione: DVGW - TÜV
		Tubo Interno: 		Tubo Interno:  

Diametro
Nominale

DN40		Nazione: Francia 		Nazione: Germania 
		Certificazione: ACS		Certificazione: TÜV
		Tubo Interno: 		Tubo Interno: 

Diametro
Nominale

DN50		Nazione: Francia 		Nazione: Germania 
		Certificazione: ACS		Certificazione: TÜV
		Tubo Interno: 		Tubo Interno: 

 Silicone EPDM

Per informazioni sulle specifiche tecniche e sui prodotti certificati si prega di rivolgersi ai nostri uffici o visitare il sito web degli enti di certificazione corrispondenti. La lista completa dei prodotti certificati NSF è consultabile al sito www.nsf.org. La lista completa dei prodotti certificati UPC/CUPC è consultabile al sito www.iapmort.org.



LUXOR®

TUBI FLESSIBILI BAGNO

1.1 / FLEXY MIX

FLEXY MIX

IDEALE PER RUBINETTERIA



È la soluzione ideale per l'allacciamento dalla rete idrica a qualsiasi tipo di rubinetto e miscelatore. La combinazione tra treccia inox e il tubo interno in EPDM

permette un collegamento flessibile, semplice e sicuro. È un prodotto di alta qualità, in conformità ai requisiti internazionali del settore.

CARATTERISTICHE TECNICHE



DN

8



Max temperatura

70 °C



Max pressione

10 bar



Portata a 3 bar

28 l/min



Raggio min. di curvatura
48 mm



Tubo interno

EPDM



Treccia

INOX AISI 304



Raccordi

CW617N

CAMPI DI APPLICAZIONE



rubinetto tradizionale



rubinetti miscelatori

TUBO INTERNO

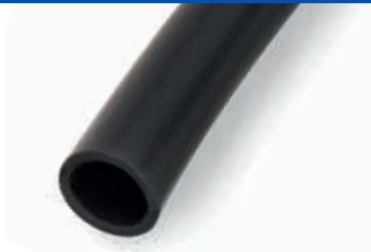

EPDM

La gomma EPDM perossidica è il materiale più utilizzato per la realizzazione del tubo interno.

Con diverse composizioni chimiche, ha proprietà igieniche e meccaniche di alto livello, unitamente ad un'assoluta resistenza all'ossidazione, agli agenti atmosferici ed alle alte temperature.

TIPOLOGIA DI RACCORDI

Maschio corto
M 10x1 - 18 mm



Maschio medio
M 10x1 - 46 mm



Femmina con guarnizione inserita
G 3/8
G 1/2



Astina con scalino
Ø 10 mm



Raccordo a stringere
G 3/8 Ø 10 mm



CERTIFICAZIONI

EN 13618
UE



Istruzioni
Pag. 444

Per informazioni sulle specifiche tecniche e sui prodotti certificati si prega di rivolgersi ai nostri uffici o visitare il sito web degli enti di certificazione corrispondenti.

FX 801

● M 10x1



● G 3/8

Maschio Corto

Femmina con guarnizione inserita

CODICE	RACCORDI	DN	LUNGHEZZA mm			
CGAKLS0200LAL	Maschio Corto M 10x1 Femmina con guarnizione inserita G 3/8	8	200	63	-	25
CGAKLS0250LAL			250	70	-	25
CGAKLS0300LAL			300	76	-	25
CGAKLS0350LAL			350	83	-	25
CGAKLS0400LAE			400	90	10	-
CGAKLS0500LAE			500	104	10	-
CGAKLS0600LAE			600	117	10	-

FX 802

● M 10x1



● G 1/2

Maschio Corto

Femmina con guarnizione inserita

CODICE	RACCORDI	DN	LUNGHEZZA mm			
CGAKJS0200LAL	Maschio Corto M 10x1 Femmina con guarnizione inserita G 1/2	8	200	78	-	25
CGAKJS0250LAL			250	85	-	25
CGAKJS0300LAL			300	92	-	25
CGAKJS0350LAL			350	99	-	25
CGAKJS0400LAE			400	106	10	-
CGAKJS0500LAE			500	119	10	-
CGAKJS0600LAE			600	133	10	-

FX 803

● M 10x1



● G 3/8

Maschio Medio

Femmina con guarnizione inserita

CODICE	RACCORDI	DN	LUNGHEZZA mm			
CGASES0200LAL	Maschio Medio M 10x1 Femmina con guarnizione inserita G 3/8	8	200	69	-	25
CGASES0250LAL			250	76	-	25
CGASES0300LAL			300	83	-	25
CGASES0350LAL			350	90	-	25
CGASES0400LAE			400	96	10	-
CGASES0500LAE			500	110	10	-
CGASES0600LAE			600	124	10	-

FX 804

● M 10x1



● G 1/2

Maschio Medio

Femmina con guarnizione inserita

CODICE	RACCORDI	DN	LUNGHEZZA mm			
CGASDS0200LAL	Maschio Medio M 10x1 Femmina con guarnizione inserita G 1/2	8	200	85	-	25
CGASDS0250LAL			250	92	-	25
CGASDS0300LAL			300	98	-	25
CGASDS0350LAL			350	105	-	25
CGASDS0400LAE			400	112	10	-
CGASDS0500LAE			500	126	10	-
CGASDS0600LAE			600	139	10	-



DN
8



Max temperatura
70 °C



Max pressione
10 bar



Portata a 3 bar
28 l/min



Raggio min. di curvatura
48 mm



Tubo interno
EPDM



Treccia
INOX AISI 304



Raccordi
CW617N



Istruzioni
Pag. 444

FX 805

● $\varnothing 10$ mm



● G 3/8 $\varnothing 10$ mm

Astina con scalino

Raccordo a stringere

CODICE	RACCORDI	DN	LUNGHEZZA mm			
CGA3GS0200LAL	Astina con scalino $\varnothing 10$ mm Raccordo a stringere G 3/8 $\varnothing 10$ mm	8	200	75	-	25
CGA3GS0250LAL			250	82	-	25
CGA3GS0300LAL			300	89	-	25
CGA3GS0350LAL			350	96	-	25
CGA3GS0400LAE			400	102	10	-
CGA3GS0500LAE			500	116	10	-
CGA3GS0600LAE			600	130	10	-



DN
8



Max temperatura
70 °C



Max pressione
10 bar



Portata a 3 bar
28 l/min



Raggio min. di curvatura
48 mm



Tubo interno
EPDM



Treccia
INOX AISI 304



Raccordi
CW617N



Istruzioni
Pag. 444



LUXOR®

TUBI FLESSIBILI BAGNO

1.2 / FLEXY MIX PT+

FLEXY MIX PT+

SPECIALE RUBINETTERIA IN SILICONE



Il tubo interno in Silicone Platinico conferisce a tubi flessibili eccellenti proprietà igieniche nonché un'elevata resistenza alla pressione e alla temperatura.

Il rivestimento interno resistente ai prodotti chimici protegge dagli additivi dell'acqua potabile. È quindi particolarmente indicato per ambienti con requisiti igienici rigorosi come per esempio strutture sanitarie.

CARATTERISTICHE TECNICHE



DN

8



Max temperatura

70 °C



Max pressione

10 bar



Portata a 3 bar

28 l/min



Raggio min. di curvatura
48 mm



Tubo interno
SILICONE



Treccia
INOX AISI 304



Raccordi
CW617N

CAMPI DI APPLICAZIONE

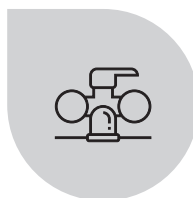

rubinetto tradizionale



rubinetti miscelatori

TUBO INTERNO



SILICONE

Il silicone platinico, materiale pregiato di altissima qualità, sta raccogliendo sempre più consenso sui mercati idrosanitari internazionali.

Questa è la versione più pura disponibile sul mercato e capace di garantire la piena alimentariet  del prodotto. Alcune delle caratteristiche peculiari sono il mantenimento di un'ottima elasticit  e delle propriet  meccaniche per tutto il range di temperatura di servizio.

TIPOLOGIA DI RACCORDI

Maschio corto
M 10x1 - 18mm



Maschio medio
M 10x1 - 46 mm



Femmina con
guarnizione
inserita
G 3/8
G 1/2



CERTIFICAZIONI

DM 174
Italia



EN 13618
UE



DVGW
Germania



Istruzioni
Pag. 444

Per informazioni sulle specifiche tecniche e sui prodotti certificati si prega di rivolgersi ai nostri uffici o visitare il sito web degli enti di certificazione corrispondenti.

FP 801

● M 10x1



● G 3/8

Maschio Corto

Femmina con guarnizione inserita

CODICE	RACCORDI	DN	LUNGHEZZA mm			
CHQKLS0200DML	Maschio Corto M 10x1 Femmina con guarnizione inserita G 3/8	8	200	58	-	25
CHQKLS0250DML			250	65	-	25
CHQKLS0300DML			300	71	-	25
CHQKLS0350DML			350	77	-	25
CHQKLS0400DME			400	84	10	-
CHQKLS0500DME			500	96	10	-
CHQKLS0600DME			600	109	10	-

FP 802

● M 10x1



● G 1/2

Maschio Corto

Femmina con guarnizione inserita

CODICE	RACCORDI	DN	LUNGHEZZA mm			
CHQKJS0200DML	Maschio Corto M 10x1 Femmina con guarnizione inserita G 1/2	8	200	62	-	25
CHQKJS0250DML			250	69	-	25
CHQKJS0300DML			300	75	-	25
CHQKJS0350DML			350	81	-	25
CHQKJS0400DME			400	88	10	-
CHQKJS0500DME			500	100	10	-
CHQKJS0600DME			600	113	10	-

FP 803

● M 10x1



● G 3/8

Maschio Medio

Femmina con guarnizione inserita

CODICE	RACCORDI	DN	LUNGHEZZA mm			
CHQSES0200DML	Maschio Medio M 10x1 Femmina con guarnizione inserita G 3/8	8	200	66	-	25
CHQSES0250DML			250	72	-	25
CHQSES0300DML			300	79	-	25
CHQSES0350DML			350	85	-	25
CHQSES0400DME			400	91	10	-
CHQSES0500DME			500	104	10	-
CHQSES0600DME			600	116	10	-

FP 804

● M 10x1



● G 1/2

Maschio Medio

Femmina con guarnizione inserita

CODICE	RACCORDI	DN	LUNGHEZZA mm			
CHQSDS0200DML	Maschio Medio M 10x1 Femmina con guarnizione inserita G 1/2	8	200	70	-	25
CHQSDS0250DML			250	76	-	25
CHQSDS0300DML			300	83	-	25
CHQSDS0350DML			350	89	-	25
CHQSDS0400DME			400	95	10	-
CHQSDS0500DME			500	108	10	-
CHQSDS0600DME			600	120	10	-



DN
8



Max temperatura
70 °C



Max pressione
10 bar



Portata a 3 bar
28 l/min



Raggio min. di curvatura
48 mm



Tubo interno
SILICONE



Trecia
INOX AISI 304



Raccordi
CW617N



Istruzioni
Pag. 444



LUXOR®

TUBI FLESSIBILI BAGNO

1.3 / OMNYFLEX 8

OMNYFLEX 8

APPLICAZIONI GENERICHE



Il tubo più tradizionale e versatile con interno in EPDM.
Questo tubo flessibile si presta a diversi campi di applicazione.

CARATTERISTICHE TECNICHE



DN

8



Max temperatura

70 °C



Max pressione

10 bar



Portata a 3 bar

28 l/min



Raggio min.
di curvatura
48 mm



Tubo interno

EPDM



Treccia

INOX AISI
304



Raccordi

CW617N

CAMPI DI APPLICAZIONE



cassette di scarico

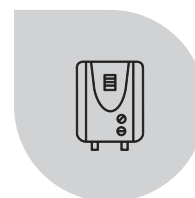

caldaie

TUBO INTERNO

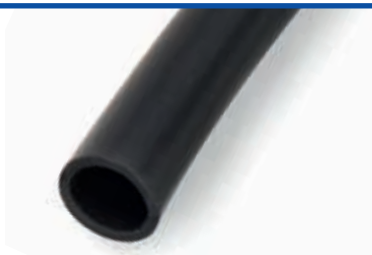

EPDM

La gomma EPDM perossidica è il materiale più utilizzato per la realizzazione del tubo interno.

Con diverse composizioni chimiche, ha proprietà igieniche e meccaniche di alto livello, unitamente ad un'assoluta resistenza all'ossidazione, agli agenti atmosferici ed alle alte temperature.

TIPOLOGIA DI RACCORDI

Maschio

G 3/8
G 1/2



Maschio Prolungato

G 3/8 - 26 mm
G 1/2 - 28 mm



Femmina con guarnizione inserita

G 3/8
G 1/2



Raccordo a stringere

G 3/8 Ø 10 mm



Maschio Girevole

G 1/2



Maschio Prolungato con rosetta scorrevole

G 3/8 - 26 mm
G 1/2 - 28 mm



CERTIFICAZIONI

EN 13618

UE



Istruzioni
Pag. 444

Per informazioni sulle specifiche tecniche e sui prodotti certificati si prega di rivolgersi ai nostri uffici o visitare il sito web degli enti di certificazione corrispondenti.

OF 801

● G 3/8



● G 3/8

Maschio

Femmina con guarnizione inserita

CODICE	RACCORDI	DN	LUNGHEZZA mm			
CGACFS0200LAL	Maschio G 3/8 Femmina con guarnizione inserita G 3/8	8	200	66	-	25
CGACFS0250LAL			250	73	-	25
CGACFS0300LAL			300	79	-	25
CGACFS0350LAL			350	85	-	25
CGACFS0400LAE			400	92	10	-
CGACFS0500LAE			500	105	10	-
CGACFS0600LAE			600	117	10	-
CGACFS0800LAE			800	143	10	-
CGACFS1000LAE			1000	169	10	-

OF 802

● G 3/8



● G 1/2

Maschio

Femmina con guarnizione inserita

CODICE	RACCORDI	DN	LUNGHEZZA mm			
CGACDS0200LAL	Maschio G 3/8 Femmina con guarnizione inserita G 1/2	8	200	69	-	25
CGACDS0250LAL			250	76	-	25
CGACDS0300LAL			300	82	-	25
CGACDS0350LAL			350	88	-	25
CGACDS0400LAE			400	95	10	-
CGACDS0500LAE			500	108	10	-
CGACDS0600LAE			600	120	10	-
CGACDS0800LAE			800	146	10	-
CGACDS1000LAE			1000	172	10	-

OF 803

● G 1/2



● G 3/8

Maschio

Femmina con guarnizione inserita

CODICE	RACCORDI	DN	LUNGHEZZA mm			
CGAEWS0200LAL	Maschio G 1/2 Femmina con guarnizione inserita G 3/8	8	200	80	-	25
CGAEWS0250LAL			250	86	-	25
CGAEWS0300LAL			300	93	-	25
CGAEWS0350LAL			350	99	-	25
CGAEWS0400LAE			400	105	10	-
CGAEWS0500LAE			500	118	10	-
CGAEWS0600LAE			600	131	10	-
CGAEWS0800LAE			800	157	10	-
CGAEWS1000LAE			1000	182	10	-

OF 804

● G 1/2



● G 1/2

Maschio

Femmina con guarnizione inserita

CODICE	RACCORDI	DN	LUNGHEZZA mm			
CGAEVS0200LAL	Maschio G 1/2 Femmina con guarnizione inserita G 1/2	8	200	83	-	25
CGAEVS0250LAL			250	89	-	25
CGAEVS0300LAL			300	96	-	25
CGAEVS0350LAL			350	102	-	25
CGAEVS0400LAE			400	108	10	-
CGAEVS0500LAE			500	121	10	-
CGAEVS0600LAE			600	134	10	-
CGAEVS0800LAE			800	160	10	-
CGAEVS1000LAE			1000	185	10	-



DN
8



Max temperatura
70 °C



Max pressione
10 bar



Portata a 3 bar
28 l/min



Raggio min. di curvatura
48 mm



Tubo interno
EPDM



Trecia
INOX AISI 304



Raccordi
CW617N



Istruzioni
Pag. 444

OF 805

● G 3/8



● G 3/8

Femmina con guarnizione inserita

Femmina con guarnizione inserita

CODICE	RACCORDI	DN	LUNGHEZZA mm			
CGAGUS0200LAL	Femmina con guarnizione inserita G 3/8	8	200	69	-	25
CGAGUS0250LAL			250	74	-	25
CGAGUS0300LAL			300	80	-	25
CGAGUS0350LAL			350	87	-	25
CGAGUS0400LAE			400	93	10	-
CGAGUS0500LAE	Femmina con guarnizione inserita G 3/8	8	500	106	10	-
CGAGUS0600LAE			600	119	10	-
CGAGUS0800LAE			800	144	10	-
CGAGUS1000LAE			1000	170	10	-

OF 806

● G 1/2



● G 3/8

Femmina con guarnizione inserita

Femmina con guarnizione inserita

CODICE	RACCORDI	DN	LUNGHEZZA mm			
CGAGNS0200LAL	Femmina con guarnizione inserita G 1/2	8	200	72	-	25
CGAGNS0250LAL			250	77	-	25
CGAGNS0300LAL			300	83	-	25
CGAGNS0350LAL			350	90	-	25
CGAGNS0400LAE			400	96	10	-
CGAGNS0500LAE	Femmina con guarnizione inserita G 3/8	8	500	109	10	-
CGAGNS0600LAE			600	122	10	-
CGAGNS0800LAE			800	147	10	-
CGAGNS1000LAE			1000	173	10	-

OF 807

● G 1/2



● G 1/2

Femmina con guarnizione inserita

Femmina con guarnizione inserita

CODICE	RACCORDI	DN	LUNGHEZZA mm			
CGAGKS0200LAL	Femmina con guarnizione inserita G 1/2	8	200	75	-	25
CGAGKS0250LAL			250	80	-	25
CGAGKS0300LAL			300	86	-	25
CGAGKS0350LAL			350	93	-	25
CGAGKS0400LAE			400	99	10	-
CGAGKS0500LAE	Femmina con guarnizione inserita G 1/2	8	500	112	10	-
CGAGKS0600LAE			600	125	10	-
CGAGKS0800LAE			800	150	10	-
CGAGKS1000LAE			1000	176	10	-



DN

8



Max temperatura

70 °C



Max pressione

10 bar



Portata a 3 bar

28 l/min



Raggio min. di curvatura

48 mm



Tubo interno

EPDM



Treccia

INOX AISI 304



Raccordi

CW617N



Istruzioni

Pag. 444

OF 808

● G 1/2



● G 3/8

Maschio Girevole

Femmina con guarnizione inserita

CODICE	RACCORDI	DN	LUNGHEZZA mm			
CGAD8S0200LAL	Maschio Girevole G 1/2 Femmina con guarnizione inserita G 3/8	8	200	104	-	25
CGAD8S0250LAL			250	110	-	25
CGAD8S0300LAL			300	116	-	25
CGAD8S0350LAL			350	123	-	25
CGAD8S0400LAE			400	129	10	-
CGAD8S0500LAE			500	142	10	-
CGAD8S0600LAE			600	155	10	-
CGAD8S0800LAE			800	180	10	-
CGAD8S1000LAE			1000	206	10	-

OF 809

● G 1/2



● G 1/2

Maschio Girevole

Femmina con guarnizione inserita

CODICE	RACCORDI	DN	LUNGHEZZA mm			
CGACMS0200LAL	Maschio Girevole G 1/2 Femmina con guarnizione inserita G 1/2	8	200	106	-	25
CGACMS0250LAL			250	112	-	25
CGACMS0300LAL			300	118	-	25
CGACMS0350LAL			350	125	-	25
CGACMS0400LAE			400	131	10	-
CGACMS0500LAE			500	144	10	-
CGACMS0600LAE			600	157	10	-
CGACMS0800LAE			800	182	10	-
CGACMS1000LAE			1000	208	10	-

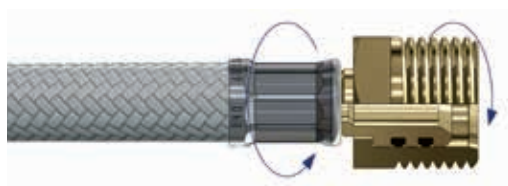

MASCHIO GIREVOLE

Il maschio girevole permette al tubo flessibile di ruotare liberamente dopo l'installazione.

Elimina i problemi di torsione e permette montaggi e destinazioni d'uso particolari.



DN
8



Max temperatura
70 °C



Max pressione
10 bar



Portata a 3 bar
28 l/min



Raggio min. di curvatura
48 mm



Tubo interno
EPDM



Treccia
INOX AISI 304



Raccordi
CW617N



Istruzioni
Pag. 444

OF 810

● G 3/8



● G 3/8

Maschio Prolungato

Femmina con guarnizione inserita

CODICE	RACCORDI	DN	LUNGHEZZA mm			
CGADJS0200LAL	Maschio Prolungato G 3/8 Femmina con guarnizione inserita G 3/8	8	200	74	-	25
CGADJS0250LAL			250	80	-	25
CGADJS0300LAL			300	87	-	25
CGADJS0350LAL			350	93	-	25
CGADJS0400LAE			400	100	10	-
CGADJS0500LAE			500	112	10	-
CGADJS0600LAE			600	125	10	-
CGADJS0800LAE			800	151	10	-
CGADJS1000LAE			1000	176	10	-

OF 811

● G 3/8



● G 1/2

Maschio Prolungato

Femmina con guarnizione inserita

CODICE	RACCORDI	DN	LUNGHEZZA mm			
CGADHS0200LAL	Maschio Prolungato G 3/8 Femmina con guarnizione inserita G 1/2	8	200	77	-	25
CGADHS0250LAL			250	83	-	25
CGADHS0300LAL			300	90	-	25
CGADHS0350LAL			350	96	-	25
CGADHS0400LAE			400	103	10	-
CGADHS0500LAE			500	115	10	-
CGADHS0600LAE			600	128	10	-
CGADHS0800LAE			800	154	10	-
CGADHS1000LAE			1000	179	10	-

OF 812

● G 1/2



● G 3/8

Maschio Prolungato

Femmina con guarnizione inserita

CODICE	RACCORDI	DN	LUNGHEZZA mm			
CGADES0200LAL	Maschio Prolungato G 1/2 Femmina con guarnizione inserita G 3/8	8	200	91	-	25
CGADES0250LAL			250	97	-	25
CGADES0300LAL			300	104	-	25
CGADES0350LAL			350	110	-	25
CGADES0400LAE			400	116	10	-
CGADES0500LAE			500	129	10	-
CGADES0600LAE			600	142	10	-
CGADES0800LAE			800	168	10	-
CGADES1000LAE			1000	193	10	-

OF 813

● G 1/2



● G 1/2

Maschio Prolungato

Femmina con guarnizione inserita

CODICE	RACCORDI	DN	LUNGHEZZA mm			
CGADDS0200LAL	Maschio Prolungato G 1/2 Femmina con guarnizione inserita G 1/2	8	200	94	-	25
CGADDS0250LAL			250	100	-	25
CGADDS0300LAL			300	107	-	25
CGADDS0350LAL			350	113	-	25
CGADDS0400LAE			400	119	10	-
CGADDS0500LAE			500	132	10	-
CGADDS0600LAE			600	145	10	-
CGADDS0800LAE			800	171	10	-
CGADDS1000LAE			1000	196	10	-



DN

8



Max temperatura

70 °C



Max pressione

10 bar



Portata a 3 bar

28 l/min



Raggio min. di curvatura

48 mm



Tubo interno

EPDM



Treccia

INOX AISI 304



Raccordi

CW617N



Istruzioni

Pag. 444

OF 814

● G 3/8



Maschio Prolungato
con rosetta scorrevole

Femmina con
guarnizione inserita

● G 3/8

CODICE	RACCORDI	DN	LUNGHEZZA mm			
CGADJS0200LAR	Maschio Prolungato con rosetta scorrevole G 3/8 Femmina con guarnizione inserita G 3/8	8	200	83	-	25
CGADJS0250LAR			250	89	-	25
CGADJS0300LAR			300	96	-	25
CGADJS0350LAR			350	102	-	25
CGADJS0400LAS			400	109	10	-
CGADJS0500LAS			500	121	10	-
CGADJS0600LAS			600	134	10	-
CGADJS0800LAS			800	160	10	-
CGADJS1000LAS			1000	185	10	-

OF 815

● G 3/8



Maschio Prolungato
con rosetta scorrevole

Femmina
con guarnizione inserita

● G 1/2

CODICE	RACCORDI	DN	LUNGHEZZA mm			
CGADHS0200LAR	Maschio Prolungato con rosetta scorrevole G 3/8 Femmina con guarnizione inserita G 1/2	8	200	86	-	25
CGADHS0250LAR			250	92	-	25
CGADHS0300LAR			300	99	-	25
CGADHS0350LAR			350	105	-	25
CGADHS0400LAS			400	112	10	-
CGADHS0500LAS			500	124	10	-
CGADHS0600LAS			600	137	10	-
CGADHS0800LAS			800	163	10	-
CGADHS1000LAS			1000	188	10	-

OF 816

● G 1/2



Maschio Prolungato
con rosetta scorrevole

Femmina con
guarnizione inserita

● G 3/8

CODICE	RACCORDI	DN	LUNGHEZZA mm			
CGADES0200LAR	Maschio Prolungato con rosetta scorrevole G 1/2 Femmina con guarnizione inserita G 3/8	8	200	99	-	25
CGADES0250LAR			250	105	-	25
CGADES0300LAR			300	112	-	25
CGADES0350LAR			350	118	-	25
CGADES0400LAS			400	124	10	-
CGADES0500LAS			500	137	10	-
CGADES0600LAS			600	150	10	-
CGADES0800LAS			800	176	10	-
CGADES1000LAS			1000	201	10	-

OF 817

● G 1/2



Maschio Prolungato
con rosetta scorrevole

Femmina con
guarnizione inserita

● G 1/2

CODICE	RACCORDI	DN	LUNGHEZZA mm			
CGADDS0200LAR	Maschio Prolungato con rosetta scorrevole G 1/2 Femmina con guarnizione inserita G 1/2	8	200	102	-	25
CGADDS0250LAR			250	108	-	25
CGADDS0300LAR			300	115	-	25
CGADDS0350LAR			350	121	-	25
CGADDS0400LAS			400	127	10	-
CGADDS0500LAS			500	140	10	-
CGADDS0600LAS			600	153	10	-
CGADDS0800LAS			800	179	10	-
CGADDS1000LAS			1000	204	10	-



DN
8



Max temperatura
70 °C



Max pressione
10 bar



Portata a 3 bar
28 l/min



Raggio min. di curvatura
48 mm



Tubo interno
EPDM



Treccia
INOX AISI 304



Raccordi
CW617N



Istruzioni
Pag. 444

OF 818

● G 3/8



● G 3/8 Ø 10 mm

Maschio

Raccordo a stringere

CODICE	RACCORDI	DN	LUNGHEZZA mm			
CGAQMS0200LAL	Maschio G 3/8 Raccordo a stringere G 3/8 Ø 10 mm	8	200	83	-	25
CGAQMS0250LAL			250	89	-	25
CGAQMS0300LAL			300	95	-	25
CGAQMS0350LAL			350	102	-	25
CGAQMS0400LAE			400	108	10	-
CGAQMS0500LAE			500	121	10	-
CGAQMS0600LAE			600	134	10	-
CGAQMS0800LAE			800	159	10	-
CGAQMS1000LAE			1000	185	10	-

OF 819

● G 1/2



● G 3/8 Ø 10 mm

Maschio

Raccordo a stringere

CODICE	RACCORDI	DN	LUNGHEZZA mm			
CGAQES0200LAL	Maschio G 1/2 Raccordo a stringere G 3/8 Ø 10 mm	8	200	96	-	25
CGAQES0250LAL			250	103	-	25
CGAQES0300LAL			300	109	-	25
CGAQES0350LAL			350	116	-	25
CGAQES0400LAE			400	122	10	-
CGAQES0500LAE			500	135	10	-
CGAQES0600LAE			600	148	10	-
CGAQES0800LAE			800	173	10	-
CGAQES1000LAE			1000	199	10	-

OF 820

● G 3/8



● G 3/8 Ø 10 mm

Femmina con guarnizione inserita

Raccordo a stringere

CODICE	RACCORDI	DN	LUNGHEZZA mm			
CGANWS0200LAL	Femmina con guarnizione inserita G 3/8 Raccordo a stringere G 3/8 Ø 10 mm	8	200	85	-	25
CGANWS0250LAL			250	92	-	25
CGANWS0300LAL			300	98	-	25
CGANWS0350LAL			350	104	-	25
CGANWS0400LAE			400	111	10	-
CGANWS0500LAE			500	124	10	-
CGANWS0600LAE			600	136	10	-
CGANWS0800LAE			800	162	10	-
CGANWS1000LAE			1000	188	10	-

OF 821

● G 1/2



● G 3/8 Ø 10 mm

Femmina con guarnizione inserita

Raccordo a stringere

CODICE	RACCORDI	DN	LUNGHEZZA mm			
CGANVS0200LAL	Femmina con guarnizione inserita G 1/2 Raccordo a stringere G 3/8 Ø 10 mm	8	200	87	-	25
CGANVS0250LAL			250	94	-	25
CGANVS0300LAL			300	100	-	25
CGANVS0350LAL			350	106	-	25
CGANVS0400LAE			400	113	10	-
CGANVS0500LAE			500	126	10	-
CGANVS0600LAE			600	138	10	-
CGANVS0800LAE			800	164	10	-
CGANVS1000LAE			1000	190	10	-



DN

8



Max temperatura

70 °C



Max pressione

10 bar



Portata a 3 bar

28 l/min



Raggio min. di curvatura

48 mm



Tubo interno

EPDM



Treccia

INOX AISI 304



Raccordi

CW617N



Istruzioni

Pag. 444

OF 822



● G 3/8



● G 3/8 Ø 10 mm

Maschio Prolungato

Raccordo a stringere

CODICE	RACCORDI	DN	LUNGHEZZA mm			
CGAQQS0200LAL	Maschio Prolungato G 3/8 Raccordo a stringere G 3/8 Ø 10 mm	8	200	91	-	25
CGAQQS0250LAL			250	97	-	25
CGAQQS0300LAL			300	103	-	25
CGAQQS0350LAL			350	110	-	25
CGAQQS0400LAE			400	116	10	-
CGAQQS0500LAE			500	117	10	-
CGAQQS0600LAE			600	130	10	-
CGAQQS0800LAE			800	156	10	-
CGAQQS1000LAE			1000	181	10	-

OF 823



● G 1/2



● G 3/8 Ø 10 mm

Maschio Prolungato

Raccordo a stringere

CODICE	RACCORDI	DN	LUNGHEZZA mm			
CGAQPS0200LAL	Maschio Prolungato G 1/2 Raccordo a stringere G 3/8 Ø 10 mm	8	200	107	-	25
CGAQPS0250LAL			250	114	-	25
CGAQPS0300LAL			300	120	-	25
CGAQPS0350LAL			350	126	-	25
CGAQPS0400LAE			400	133	10	-
CGAQPS0500LAE			500	134	10	-
CGAQPS0600LAE			600	147	10	-
CGAQPS0800LAE			800	173	10	-
CGAQPS1000LAE			1000	198	10	-



OF 824

● G 3/8



● G 3/8 Ø 10 mm

Maschio Prolungato
con rosetta scorrevoleRaccordo
a stringere

CODICE	RACCORDI	DN	LUNGHEZZA mm			
CGAQQS0200LAR	Maschio Prolungato con rosetta scorrevole G 3/8 Raccordo a stringere G 3/8 Ø 10 mm	8	200	100	-	25
CGAQQS0250LAR			250	106	-	25
CGAQQS0300LAR			300	112	-	25
CGAQQS0350LAR			350	119	-	25
CGAQQS0400LAS			400	125	10	-
CGAQQS0500LAS			500	126	10	-
CGAQQS0600LAS			600	139	10	-
CGAQQS0800LAS			800	165	10	-
CGAQQS1000LAS			1000	190	10	-



OF 825

● G 1/2



● G 3/8 Ø 10 mm

Maschio Prolungato
con rosetta scorrevoleRaccordo
a stringere

CODICE	RACCORDI	DN	LUNGHEZZA mm			
CGAQPS0200LAR	Maschio Prolungato con rosetta scorrevole G 1/2 Raccordo a stringere G 3/8 Ø 10 mm	8	200	115	-	25
CGAQPS0250LAR			250	122	-	25
CGAQPS0300LAR			300	128	-	25
CGAQPS0350LAR			350	134	-	25
CGAQPS0400LAS			400	141	10	-
CGAQPS0500LAS			500	142	10	-
CGAQPS0600LAS			600	155	10	-
CGAQPS0800LAS			800	181	10	-
CGAQPS1000LAS			1000	206	10	-



DN

8



Max temperatura

70 °C



Max pressione

10 bar



Portata a 3 bar

28 l/min



Raggio min. di curvatura

48 mm



Tubo interno

EPDM



Treccia

INOX AISI 304



Raccordi

CW617N



Istruzioni

Pag. 444



LUXOR®

TUBI FLESSIBILI BAGNO

1.4 / OMNYFLEX PT+

OMNYFLEX PT+

APPLICAZIONI IN SILICONE



Il tubo più tradizionale e versatile con interno in silicone, adatto a diversi campi di applicazione. Il tubo interno in silicone platinico garantisce inoltre altissimi standard qualitativi,

rendendo OMNYFLEX PT+ la soluzione ideale per installazioni in ambienti con requisiti igienici rigorosi.

CARATTERISTICHE TECNICHE



DN

8



Max temperatura

70 °C



Max pressione

10 bar



Portata a 3 bar

28 l/min



Raggio min. di curvatura
48 mm



Tubo interno

SILICONE



Treccia

INOX AISI 304



Raccordi

CW617N

CAMPI DI APPLICAZIONE



cassette di scarico

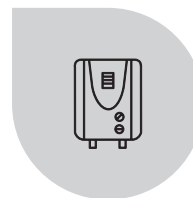

caldaie

TUBO INTERNO



SILICONE

Il silicone platinico, materiale pregiato di altissima qualità, sta raccogliendo sempre più consenso sui mercati idrosanitari internazionali.

Questa è la versione più pura disponibile sul mercato e capace di garantire la piena alimentariet  del prodotto. Alcune delle caratteristiche peculiari sono il mantenimento di un'ottima elasticit  e delle propriet  meccaniche per tutto il range di temperatura di servizio.

TIPOLOGIA DI RACCORDI

Maschio

G 3/8
G 1/2



Maschio Prolungato

G 3/8 - 26 mm
G 1/2 - 28 mm



Femmina con guarnizione inserita

G 3/8
G 1/2



Maschio Prolungato con rosetta scorrevole

G 3/8 - 26 mm
G 1/2 - 28 mm



CERTIFICAZIONI

DM 174

Italia



EN 13618

UE



DVGW

Germania



Istruzioni
Pag. 444

Per informazioni sulle specifiche tecniche e sui prodotti certificati si prega di rivolgersi ai nostri uffici o visitare il sito web degli enti di certificazione corrispondenti.

OP 801

● G 3/8



● G 3/8

Maschio

Femmina con guarnizione inserita

CODICE	RACCORDI	DN	LUNGHEZZA mm			
CHQCFS0200DML	Maschio G 3/8 Femmina con guarnizione inserita G 3/8	8	200	66	-	25
CHQCFS0250DML			250	72	-	25
CHQCFS0300DML			300	78	-	25
CHQCFS0350DML			350	85	-	25
CHQCFS0400DME			400	91	10	-
CHQCFS0500DME			500	104	10	-
CHQCFS0600DME			600	116	10	-
CHQCFS0800DME			800	141	10	-
CHQCFS1000DME			1000	167	10	-

OP 802

● G 3/8



● G 1/2

Maschio

Femmina con guarnizione inserita

CODICE	RACCORDI	DN	LUNGHEZZA mm			
CHQCDS0200DML	Maschio G 3/8 Femmina con guarnizione inserita G 1/2	8	200	70	-	25
CHQCDS0250DML			250	76	-	25
CHQCDS0300DML			300	82	-	25
CHQCDS0350DML			350	89	-	25
CHQCDS0400DME			400	95	10	-
CHQCDS0500DME			500	108	10	-
CHQCDS0600DME			600	120	10	-
CHQCDS0800DME			800	145	10	-
CHQCDS1000DME			1000	171	10	-

OP 803

● G 1/2



● G 3/8

Maschio

Femmina con guarnizione inserita

CODICE	RACCORDI	DN	LUNGHEZZA mm			
CHQEWS0200DML	Maschio G 1/2 Femmina con guarnizione inserita G 3/8	8	200	79	-	25
CHQEWS0250DML			250	86	-	25
CHQEWS0300DML			300	92	-	25
CHQEWS0350DML			350	98	-	25
CHQEWS0400DME			400	105	10	-
CHQEWS0500DME			500	117	10	-
CHQEWS0600DME			600	130	10	-
CHQEWS0800DME			800	155	10	-
CHQEWS1000DME			1000	180	10	-

OP 804

● G 1/2



● G 1/2

Maschio

Femmina con guarnizione inserita

CODICE	RACCORDI	DN	LUNGHEZZA mm			
CHQEVS0200DML	Maschio G 1/2 Femmina con guarnizione inserita G 1/2	8	200	83	-	25
CHQEVS0250DML			250	90	-	25
CHQEVS0300DML			300	96	-	25
CHQEVS0350DML			350	102	-	25
CHQEVS0400DME			400	109	10	-
CHQEVS0500DME			500	121	10	-
CHQEVS0600DME			600	134	10	-
CHQEVS0800DME			800	159	10	-
CHQEVS1000DME			1000	184	10	-



DN
8



Max temperatura
70 °C



Max pressione
10 bar



Portata a 3 bar
28 l/min



Raggio min. di curvatura
48 mm



Tubo interno
SILICONE



Treccia
INOX AISI 304



Raccordi
CW617N



Istruzioni
Pag. 444

OP 805

● G 3/8



● G 3/8

Femmina con guarnizione inserita

Femmina con guarnizione inserita

CODICE	RACCORDI	DN	LUNGHEZZA mm			
CHQGUS0200DML	Femmina con guarnizione inserita G 3/8	8	200	68	-	25
CHQGUS0250DML			250	74	-	25
CHQGUS0300DML			300	81	-	25
CHQGUS0350DML			350	87	-	25
CHQGUS0400DME	Femmina con guarnizione inserita G 3/8	8	400	93	10	-
CHQGUS0500DME			500	106	10	-
CHQGUS0600DME			600	119	10	-
CHQGUS0800DME			800	144	10	-
CHQGUS1000DME			1000	169	10	-

OP 806

● G 3/8



● G 1/2

Femmina con guarnizione inserita

Femmina con guarnizione inserita

CODICE	RACCORDI	DN	LUNGHEZZA mm			
CHQGNS0200DML	Femmina con guarnizione inserita G 3/8	8	200	72	-	25
CHQGNS0250DML			250	78	-	25
CHQGNS0300DML			300	85	-	25
CHQGNS0350DML			350	91	-	25
CHQGNS0400DME	Femmina con guarnizione inserita G 1/2	8	400	97	10	-
CHQGNS0500DME			500	110	10	-
CHQGNS0600DME			600	123	10	-
CHQGNS0800DME			800	148	10	-
CHQGNS1000DME			1000	173	10	-

OP 807

● G 1/2



● G 1/2

Femmina con guarnizione inserita

Femmina con guarnizione inserita

CODICE	RACCORDI	DN	LUNGHEZZA mm			
CHQGKS0200DML	Femmina con guarnizione inserita G 1/2	8	200	76	-	25
CHQGKS0250DML			250	82	-	25
CHQGKS0300DML			300	89	-	25
CHQGKS0350DML			350	95	-	25
CHQGKS0400DME	Femmina con guarnizione inserita G 1/2	8	400	101	10	-
CHQGKS0500DME			500	114	10	-
CHQGKS0600DME			600	127	10	-
CHQGKS0800DME			800	152	10	-
CHQGKS1000DME			1000	177	10	-



DN
8



Max temperatura
70 °C



Max pressione
10 bar



Portata a 3 bar
28 l/min



Raggio min. di curvatura
48 mm



Tubo interno
SILICONE



Treccia
INOX AISI 304



Raccordi
CW617N



Istruzioni
Pag. 444

OP 808

● G 3/8



● G 3/8

Maschio Prolungato

Femmina con guarnizione inserita

CODICE	RACCORDI	DN	LUNGHEZZA mm			
CHQDJS0200DML	Maschio Prolungato G 3/8 Femmina con guarnizione inserita G 3/8	8	200	73	-	25
CHQDJS0250DML			250	80	-	25
CHQDJS0300DML			300	86	-	25
CHQDJS0350DML			350	92	-	25
CHQDJS0400DME			400	99	10	-
CHQDJS0500DME			500	111	10	-
CHQDJS0600DME			600	124	10	-
CHQDJS0800DME			800	149	10	-
CHQDJS1000DME			1000	175	10	-

OP 809

● G 3/8



● G 1/2

Maschio Prolungato

Femmina con guarnizione inserita

CODICE	RACCORDI	DN	LUNGHEZZA mm			
CHQDHS0200DML	Maschio Prolungato G 3/8 Femmina con guarnizione inserita G 1/2	8	200	77	-	25
CHQDHS0250DML			250	84	-	25
CHQDHS0300DML			300	90	-	25
CHQDHS0350DML			350	96	-	25
CHQDHS0400DME			400	103	10	-
CHQDHS0500DME			500	115	10	-
CHQDHS0600DME			600	128	10	-
CHQDHS0800DME			800	153	10	-
CHQDHS1000DME			1000	179	10	-

OP 810

● G 1/2



● G 3/8

Maschio Prolungato

Femmina con guarnizione inserita

CODICE	RACCORDI	DN	LUNGHEZZA mm			
CHQDES0200DML	Maschio Prolungato G 1/2 Femmina con guarnizione inserita G 3/8	8	200	90	-	25
CHQDES0250DML			250	97	-	25
CHQDES0300DML			300	103	-	25
CHQDES0350DML			350	109	-	25
CHQDES0400DME			400	115	10	-
CHQDES0500DME			500	128	10	-
CHQDES0600DME			600	141	10	-
CHQDES0800DME			800	166	10	-
CHQDES1000DME			1000	191	10	-

OP 811

● G 1/2



● G 1/2

Maschio Prolungato

Femmina con guarnizione inserita

CODICE	RACCORDI	DN	LUNGHEZZA mm			
CHQDDS0200DML	Maschio Prolungato G 1/2 Femmina con guarnizione inserita G 1/2	8	200	94	-	25
CHQDDS0250DML			250	101	-	25
CHQDDS0300DML			300	107	-	25
CHQDDS0350DML			350	113	-	25
CHQDDS0400DME			400	119	10	-
CHQDDS0500DME			500	132	10	-
CHQDDS0600DME			600	145	10	-
CHQDDS0800DME			800	170	10	-
CHQDDS1000DME			1000	195	10	-



DN
8



Max temperatura
70 °C



Max pressione
10 bar



Portata a 3 bar
28 l/min



Raggio min. di curvatura
48 mm



Tubo interno
SILICONE



Trecia
INOX AISI 304



Raccordi
CW617N



Istruzioni
Pag. 444

OP 812

● G 3/8



Maschio Prolungato
con rosetta scorrevole

Femmina con
guarnizione inserita

● G 3/8

CODICE	RACCORDI	DN	LUNGHEZZA mm			
CHQDJS0200DMR	Maschio Prolungato con rosetta scorrevole G 3/8 Femmina con guarnizione inserita G 3/8	8	200	103	-	25
CHQDJS0250DMR			250	110	-	25
CHQDJS0300DMR			300	116	-	25
CHQDJS0350DMR			350	122	-	25
CHQDJS0400DMS			400	129	10	-
CHQDJS0500DMS			500	141	10	-
CHQDJS0600DMS			600	154	10	-
CHQDJS0800DMS			800	179	10	-
CHQDJS1000DMS			1000	205	10	-

OP 813

● G 3/8



Maschio Prolungato
con rosetta scorrevole

Femmina con
guarnizione inserita

● G 1/2

CODICE	RACCORDI	DN	LUNGHEZZA mm			
CHQDHS0200DMR	Maschio Prolungato con rosetta scorrevole G 3/8 Femmina con guarnizione inserita G 1/2	8	200	99	-	25
CHQDHS0250DMR			250	106	-	25
CHQDHS0300DMR			300	112	-	25
CHQDHS0350DMR			350	118	-	25
CHQDHS0400DMS			400	125	10	-
CHQDHS0500DMS			500	137	10	-
CHQDHS0600DMS			600	150	10	-
CHQDHS0800DMS			800	175	10	-
CHQDHS1000DMS			1000	201	10	-

OP 814

● G 1/2



Maschio Prolungato
con rosetta scorrevole

Femmina con
guarnizione inserita

● G 3/8

CODICE	RACCORDI	DN	LUNGHEZZA mm			
CHQDES0200DMR	Maschio Prolungato con rosetta scorrevole G 1/2 Femmina con guarnizione inserita G 3/8	8	200	87	-	25
CHQDES0250DMR			250	93	-	25
CHQDES0300DMR			300	99	-	25
CHQDES0350DMR			350	106	-	25
CHQDES0400DMS			400	112	10	-
CHQDES0500DMS			500	125	10	-
CHQDES0600DMS			600	137	10	-
CHQDES0800DMS			800	163	10	-
CHQDES1000DMS			1000	188	10	-

OP 815

● G 1/2



Maschio Prolungato
con rosetta scorrevole

Femmina con
guarnizione inserita

● G 1/2

CODICE	RACCORDI	DN	LUNGHEZZA mm			
CHQDDS0200DMR	Maschio Prolungato con rosetta scorrevole G 1/2 Femmina con guarnizione inserita G 1/2	8	200	83	-	25
CHQDDS0250DMR			250	89	-	25
CHQDDS0300DMR			300	95	-	25
CHQDDS0350DMR			350	102	-	25
CHQDDS0400DMS			400	108	10	-
CHQDDS0500DMS			500	121	10	-
CHQDDS0600DMS			600	133	10	-
CHQDDS0800DMS			800	159	10	-
CHQDDS1000DMS			1000	184	10	-



DN
8



Max temperatura
70 °C



Max pressione
10 bar



Portata a 3 bar
28 l/min



Raggio min. di curvatura
48 mm



Tubo interno
SILICONE



Trezza
INOX AISI 304



Raccordi
CW617N



Istruzioni
Pag. 444



LUXOR®

TUBI FLESSIBILI BAGNO

1.5 / OMNYFLEX 10

OMNYFLEX 10

APPLICAZIONI GENERICHE



È la soluzione ideale per l'allacciamento dalla rete idrica a scaldabagni e caldaie. Il diametro maggiore permette portate più elevate e assicura controllo della pressione.

CARATTERISTICHE TECNICHE



DN

10



Max temperatura

70 °C



Max pressione

10 bar



Portata a 3 bar

46 l/min



Raggio min. di curvatura
56 mm



Tubo interno

EPDM



Treccia

INOX AISI 304



Raccordi

CW617N

CAMPI DI APPLICAZIONE

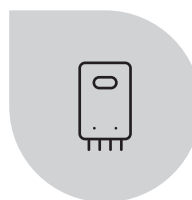

scaldabagni

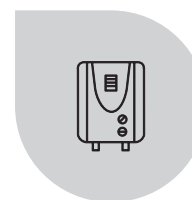

caldaie

TUBO INTERNO

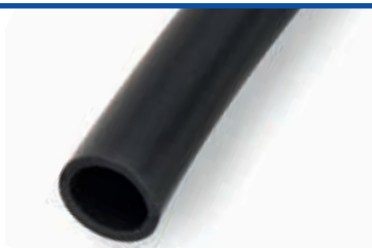

EPDM

La gomma EPDM perossidica è il materiale più utilizzato per la realizzazione del tubo interno.

Con diverse composizioni chimiche, ha proprietà igieniche e meccaniche di alto livello, unitamente ad un'assoluta resistenza all'ossidazione, agli agenti atmosferici ed alle alte temperature.

TIPOLOGIA DI RACCORDI

Maschio

G 3/8
G 1/2



Maschio Prolungato

G 3/8 - 26 mm
G 1/2 - 28 mm



Femmina con guarnizione inserita

G 3/8
G 1/2



Raccordo a Stringere

G 3/8 Ø 10 mm



Maschio Girevole

G 1/2



Maschio Prolungato con rosetta scorrevole

G 3/8 - 26 mm
G 1/2 - 28 mm



CERTIFICAZIONI

EN 13618

UE



Istruzioni
Pag. 444

Per informazioni sulle specifiche tecniche e sui prodotti certificati si prega di rivolgersi ai nostri uffici o visitare il sito web degli enti di certificazione corrispondenti.

OF 1001

● G 3/8



● G 3/8

Maschio

Femmina con guarnizione inserita

CODICE	RACCORDI	DN	LUNGHEZZA mm			
FGACFS0200LAL	Maschio G 3/8 Femmina con guarnizione inserita G 3/8	10	200	70	-	25
FGACFS0250LAL			250	78	-	25
FGACFS0300LAL			300	86	-	25
FGACFS0350LAL			350	93	-	25
FGACFS0400LAE			400	101	10	-
FGACFS0500LAE			500	116	10	-
FGACFS0600LAE			600	131	10	-
FGACFS0800LAE			800	161	10	-
FGACFS1000LAE			1000	191	10	-

OF 1002

● G 3/8



● G 1/2

Maschio

Femmina con guarnizione inserita

CODICE	RACCORDI	DN	LUNGHEZZA mm			
FGACDS0200LAL	Maschio G 3/8 Femmina con guarnizione inserita G 1/2	10	200	74	-	25
FGACDS0250LAL			250	82	-	25
FGACDS0300LAL			300	90	-	25
FGACDS0350LAL			350	97	-	25
FGACDS0400LAE			400	105	10	-
FGACDS0500LAE			500	120	10	-
FGACDS0600LAE			600	135	10	-
FGACDS0800LAE			800	165	10	-
FGACDS1000LAE			1000	195	10	-

OF 1003

● G 1/2



● G 3/8

Maschio

Femmina con guarnizione inserita

CODICE	RACCORDI	DN	LUNGHEZZA mm			
FGAAVS0200LAL	Maschio G 1/2 Femmina con guarnizione inserita G 3/8	10	200	82	-	25
FGAAVS0250LAL			250	89	-	25
FGAAVS0300LAL			300	97	-	25
FGAAVS0350LAL			350	104	-	25
FGAAVS0400LAE			400	112	10	-
FGAAVS0500LAE			500	127	10	-
FGAAVS0600LAE			600	142	10	-
FGAAVS0800LAE			800	172	10	-
FGAAVS1000LAE			1000	203	10	-

OF 1004

● G 1/2



● G 1/2

Maschio

Femmina con guarnizione inserita

CODICE	RACCORDI	DN	LUNGHEZZA mm			
FGAASS0200LAL	Maschio G 1/2 Femmina con guarnizione inserita G 1/2	10	200	86	-	25
FGAASS0250LAL			250	94	-	25
FGAASS0300LAL			300	101	-	25
FGAASS0350LAL			350	109	-	25
FGAASS0400LAE			400	116	10	-
FGAASS0500LAE			500	131	10	-
FGAASS0600LAE			600	147	10	-
FGAASS0800LAE			800	178	10	-
FGAASS1000LAE			1000	207	10	-



DN
10



Max temperatura
70 °C



Max pressione
10 bar



Portata a 3 bar
46 l/min



Raggio min. di curvatura
56 mm



Tubo interno
EPDM



Treccia
INOX AISI 304



Raccordi
CW617N



Istruzioni
Pag. 444

OF 1005

● G 3/8



● G 3/8

Femmina con guarnizione inserita

Femmina con guarnizione inserita

CODICE	RACCORDI	DN	LUNGHEZZA mm			
FGAGUS0200LAL	Femmina con guarnizione inserita G 3/8	10	200	74	-	25
FGAGUS0250LAL			250	81	-	25
FGAGUS0300LAL			300	89	-	25
FGAGUS0350LAL			350	96	-	25
FGAGUS0400LAE	Femmina con guarnizione inserita G 3/8	10	400	104	10	-
FGAGUS0500LAE			500	119	10	-
FGAGUS0600LAE			600	134	10	-
FGAGUS0800LAE			800	164	10	-
FGAGUS1000LAE			1000	195	10	-

OF 1006

● G 1/2



● G 3/8

Femmina con guarnizione inserita

Femmina con guarnizione inserita

CODICE	RACCORDI	DN	LUNGHEZZA mm			
FGAGNS0200LAL	Femmina con guarnizione inserita G 1/2	10	200	78	-	25
FGAGNS0250LAL			250	85	-	25
FGAGNS0300LAL			300	93	-	25
FGAGNS0350LAL			350	100	-	25
FGAGNS0400LAE	Femmina con guarnizione inserita G 3/8	10	400	108	10	-
FGAGNS0500LAE			500	123	10	-
FGAGNS0600LAE			600	138	10	-
FGAGNS0800LAE			800	168	10	-
FGAGNS1000LAE			1000	199	10	-

OF 1007

● G 1/2



● G 1/2

Femmina con guarnizione inserita

Femmina con guarnizione inserita

CODICE	RACCORDI	DN	LUNGHEZZA mm			
FGAGKS0200LAL	Femmina con guarnizione inserita G 1/2	10	200	82	-	25
FGAGKS0250LAL			250	89	-	25
FGAGKS0300LAL			300	97	-	25
FGAGKS0350LAL			350	105	-	25
FGAGKS0400LAE	Femmina con guarnizione inserita G 1/2	10	400	112	10	-
FGAGKS0500LAE			500	127	10	-
FGAGKS0600LAE			600	142	10	-
FGAGKS0800LAE			800	172	10	-
FGAGKS1000LAE			1000	203	10	-



DN
10



Max temperatura
70 °C



Max pressione
10 bar



Portata a 3 bar
46 l/min



Raggio min. di curvatura
56 mm



Tubo interno
EPDM



Treccia
INOX AISI 304



Raccordi
CW617N



Istruzioni
Pag. 444

OF 1008

● G 1/2



● G 3/8

Maschio Girevole

Femmina con guarnizione inserita

CODICE	RACCORDI	DN	LUNGHEZZA mm			
FGAD8S0200LAL	Maschio Girevole G 1/2 Femmina con guarnizione inserita G 3/8	10	200	96	-	25
FGAD8S0250LAL			250	104	-	25
FGAD8S0300LAL			300	111	-	25
FGAD8S0350LAL			350	119	-	25
FGAD8S0400LAE			400	127	10	-
FGAD8S0500LAE			500	142	10	-
FGAD8S0600LAE			600	157	10	-
FGAD8S0800LAE			800	187	10	-
FGAD8S1000LAE			1000	217	10	-

OF 1009

● G 1/2



● G 1/2

Maschio Girevole

Femmina con guarnizione inserita

CODICE	RACCORDI	DN	LUNGHEZZA mm			
FGACMS0200LAL	Maschio Girevole G 1/2 Femmina con guarnizione inserita G 1/2	10	200	100	-	25
FGACMS0250LAL			250	108	-	25
FGACMS0300LAL			300	115	-	25
FGACMS0350LAL			350	123	-	25
FGACMS0400LAE			400	131	10	-
FGACMS0500LAE			500	146	10	-
FGACMS0600LAE			600	161	10	-
FGACMS0800LAE			800	191	10	-
FGACMS1000LAE			1000	221	10	-

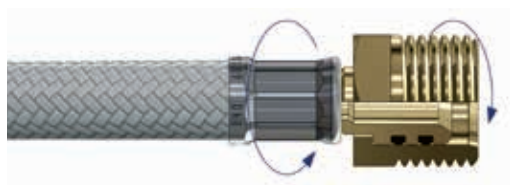

MASCHIO GIREVOLE

Il maschio girevole permette al tubo flessibile di ruotare liberamente dopo l'installazione.

Elimina i problemi di torsione e permette montaggi e destinazioni d'uso particolari.



DN
10



Max temperatura
70 °C



Max pressione
10 bar



Portata a 3 bar
46 l/min



Raggio min. di curvatura
56 mm



Tubo interno
EPDM



Treccia
INOX AISI 304



Raccordi
CW617N



Istruzioni
Pag. 444

OF 1010

● G 3/8



● G 3/8

Maschio Prolungato

Femmina con guarnizione inserita

CODICE	RACCORDI	DN	LUNGHEZZA mm			
FGADJS0200LAL	Maschio Prolungato G 3/8 Femmina con guarnizione inserita G 3/8	10	200	81	-	25
FGADJS0250LAL			250	89	-	25
FGADJS0300LAL			300	97	-	25
FGADJS0350LAL			350	104	-	25
FGADJS0400LAE			400	112	10	-
FGADJS0500LAE			500	127	10	-
FGADJS0600LAE			600	142	10	-
FGADJS0800LAE			800	172	10	-
FGADJS1000LAE			1000	202	10	-

OF 1011

● G 3/8



● G 1/2

Maschio Prolungato

Femmina con guarnizione inserita

CODICE	RACCORDI	DN	LUNGHEZZA mm			
FGADHS0200LAL	Maschio Prolungato G 3/8 Femmina con guarnizione inserita G 1/2	10	200	85	-	25
FGADHS0250LAL			250	93	-	25
FGADHS0300LAL			300	101	-	25
FGADHS0350LAL			350	108	-	25
FGADHS0400LAE			400	116	10	-
FGADHS0500LAE			500	131	10	-
FGADHS0600LAE			600	146	10	-
FGADHS0800LAE			800	176	10	-
FGADHS1000LAE			1000	206	10	-

OF 1012

● G 1/2



● G 3/8

Maschio Prolungato

Femmina con guarnizione inserita

CODICE	RACCORDI	DN	LUNGHEZZA mm			
FGADES0200LAL	Maschio Prolungato G 1/2 Femmina con guarnizione inserita G 3/8	10	200	103	-	25
FGADES0250LAL			250	111	-	25
FGADES0300LAL			300	118	-	25
FGADES0350LAL			350	126	-	25
FGADES0400LAE			400	133	10	-
FGADES0500LAE			500	148	10	-
FGADES0600LAE			600	163	10	-
FGADES0800LAE			800	194	10	-
FGADES1000LAE			1000	224	10	-

OF 1013

● G 1/2



● G 1/2

Maschio Prolungato

Femmina con guarnizione inserita

CODICE	RACCORDI	DN	LUNGHEZZA mm			
FGADDS0200LAL	Maschio Prolungato G 1/2 Femmina con guarnizione inserita G 1/2	10	200	107	-	25
FGADDS0250LAL			250	115	-	25
FGADDS0300LAL			300	122	-	25
FGADDS0350LAL			350	130	-	25
FGADDS0400LAE			400	137	10	-
FGADDS0500LAE			500	152	10	-
FGADDS0600LAE			600	167	10	-
FGADDS0800LAE			800	198	10	-
FGADDS1000LAE			1000	228	10	-



DN

10



Max temperatura

70 °C



Max pressione

10 bar



Portata a 3 bar

46 l/min



Raggio min. di curvatura

56 mm



Tubo interno

EPDM



Treccia

INOX AISI 304



Raccordi

CW617N



Istruzioni

Pag. 444

OF 1014

● G 3/8



● G 3/8

Maschio Prolungato
con rosetta scorrevole

Femmina con
guarnizione inserita

CODICE	RACCORDI	DN	LUNGHEZZA mm			
FGADJS0200LAR	Maschio Prolungato con rosetta scorrevole G 3/8 Femmina con guarnizione inserita G 3/8	10	200	90	-	25
FGADJS0250LAR			250	98	-	25
FGADJS0300LAR			300	106	-	25
FGADJS0350LAR			350	113	-	25
FGADJS0400LAS			400	121	10	-
FGADJS0500LAS			500	136	10	-
FGADJS0600LAS			600	151	10	-
FGADJS0800LAS			800	181	10	-
FGADJS1000LAS			1000	211	10	-

OF 1015

● G 3/8



● G 1/2

Maschio Prolungato
con rosetta scorrevole

Femmina con
guarnizione inserita

CODICE	RACCORDI	DN	LUNGHEZZA mm			
FGADHS0200LAR	Maschio Prolungato con rosetta scorrevole G 3/8 Femmina con guarnizione inserita G 1/2	10	200	94	-	25
FGADHS0250LAR			250	102	-	25
FGADHS0300LAR			300	110	-	25
FGADHS0350LAR			350	117	-	25
FGADHS0400LAS			400	125	10	-
FGADHS0500LAS			500	140	10	-
FGADHS0600LAS			600	155	10	-
FGADHS0800LAS			800	185	10	-
FGADHS1000LAS			1000	215	10	-

OF 1016

● G 1/2



● G 3/8

Maschio Prolungato
con rosetta scorrevole

Femmina con
guarnizione inserita

CODICE	RACCORDI	DN	LUNGHEZZA mm			
FGADES0200LAR	Maschio Prolungato con rosetta scorrevole G 1/2 Femmina con guarnizione inserita G 3/8	10	200	111	-	25
FGADES0250LAR			250	119	-	25
FGADES0300LAR			300	126	-	25
FGADES0350LAR			350	134	-	25
FGADES0400LAS			400	141	10	-
FGADES0500LAS			500	156	10	-
FGADES0600LAS			600	171	10	-
FGADES0800LAS			800	202	10	-
FGADES1000LAS			1000	232	10	-

OF 1017

● G 1/2



● G 1/2

Maschio Prolungato
con rosetta scorrevole

Femmina con
guarnizione inserita

CODICE	RACCORDI	DN	LUNGHEZZA mm			
FGADDS0200LAR	Maschio Prolungato con rosetta scorrevole G 1/2 Femmina con guarnizione inserita G 1/2	10	200	115	-	25
FGADDS0250LAR			250	123	-	25
FGADDS0300LAR			300	130	-	25
FGADDS0350LAR			350	138	-	25
FGADDS0400LAS			400	145	10	-
FGADDS0500LAS			500	160	10	-
FGADDS0600LAS			600	175	10	-
FGADDS0800LAS			800	206	10	-
FGADDS1000LAS			1000	236	10	-



DN
10



Max temperatura
70 °C



Max pressione
10 bar



Portata a 3 bar
46 l/min



Raggio min. di curvatura
56 mm



Tubo interno
EPDM



Treccia
INOX AISI 304



Raccordi
CW617N



Istruzioni
Pag. 444

OF 1018

● G 3/8



● G 3/8 Ø 10 mm

Maschio

Raccordo a stringere

CODICE	RACCORDI	DN	LUNGHEZZA mm			
FGAQMS0200LAL	Maschio G 3/8 Raccordo a stringere G 3/8 Ø 10 mm	10	200	85	-	25
FGAQMS0250LAL			250	92	-	25
FGAQMS0300LAL			300	100	-	25
FGAQMS0350LAL			350	108	-	25
FGAQMS0400LAE			400	115	10	-
FGAQMS0500LAE			500	130	10	-
FGAQMS0600LAE			600	145	10	-
FGAQMS0800LAE			800	176	10	-
FGAQMS1000LAE			1000	206	10	-

OF 1019

● G 1/2



● G 3/8 Ø 10 mm

Maschio

Raccordo a stringere

CODICE	RACCORDI	DN	LUNGHEZZA mm			
FGAQES0200LAL	Maschio G 1/2 Raccordo a stringere G 3/8 Ø 10 mm	10	200	96	-	25
FGAQES0250LAL			250	104	-	25
FGAQES0300LAL			300	111	-	25
FGAQES0350LAL			350	119	-	25
FGAQES0400LAE			400	126	10	-
FGAQES0500LAE			500	142	10	-
FGAQES0600LAE			600	157	10	-
FGAQES0800LAE			800	187	10	-
FGAQES1000LAE			1000	217	10	-

OF 1020

● G 3/8



● G 3/8 Ø 10 mm

Femmina con guarnizione inserita

Raccordo a stringere

CODICE	RACCORDI	DN	LUNGHEZZA mm			
FGANWS0200LAL	Femmina con guarnizione inserita G 3/8 Raccordo a stringere G 3/8 Ø 10 mm	10	200	88	-	25
FGANWS0250LAL			250	96	-	25
FGANWS0300LAL			300	103	-	25
FGANWS0350LAL			350	111	-	25
FGANWS0400LAE			400	118	10	-
FGANWS0500LAE			500	134	10	-
FGANWS0600LAE			600	149	10	-
FGANWS0800LAE			800	179	10	-
FGANWS1000LAE			1000	209	10	-

OF 1021

● G 1/2



● G 3/8 Ø 10 mm

Femmina con guarnizione inserita

Raccordo a stringere

CODICE	RACCORDI	DN	LUNGHEZZA mm			
FGANVS0200LAL	Femmina con guarnizione inserita G 1/2 Raccordo a stringere G 3/8 Ø 10 mm	10	200	92	-	25
FGANVS0250LAL			250	100	-	25
FGANVS0300LAL			300	107	-	25
FGANVS0350LAL			350	115	-	25
FGANVS0400LAE			400	122	10	-
FGANVS0500LAE			500	138	10	-
FGANVS0600LAE			600	153	10	-
FGANVS0800LAE			800	183	10	-
FGANVS1000LAE			1000	213	10	-



DN
10



Max temperatura
70 °C



Max pressione
10 bar



Portata a 3 bar
46 l/min



Raggio min. di curvatura
56 mm



Tubo interno
EPDM



Treccia
INOX AISI 304



Raccordi
CW617N



Istruzioni
Pag. 444

OF 1022

● G 3/8



● G 3/8 Ø 10 mm

Maschio Prolungato

Raccordo a stringere

CODICE	RACCORDI	DN	LUNGHEZZA mm			
FGAQQS0200LAL	Maschio Prolungato G 3/8 Raccordo a stringere G 3/8 Ø 10 mm	10	200	96	-	25
FGAQQS0250LAL			250	104	-	25
FGAQQS0300LAL			300	111	-	25
FGAQQS0350LAL			350	119	-	25
FGAQQS0400LAE			400	126	10	-
FGAQQS0500LAE			500	141	10	-
FGAQQS0600LAE			600	156	10	-
FGAQQS0800LAE			800	187	10	-
FGAQQS1000LAE			1000	217	10	-

OF 1023

● G 1/2



● G 3/8 Ø 10 mm

Maschio Prolungato

Raccordo a stringere

CODICE	RACCORDI	DN	LUNGHEZZA mm			
FGAQPS0200LAL	Maschio Prolungato G 1/2 Raccordo a stringere G 3/8 Ø 10 mm	10	200	118	-	25
FGAQPS0250LAL			250	125	-	25
FGAQPS0300LAL			300	133	-	25
FGAQPS0350LAL			350	140	-	25
FGAQPS0400LAE			400	148	10	-
FGAQPS0500LAE			500	163	10	-
FGAQPS0600LAE			600	178	10	-
FGAQPS0800LAE			800	208	10	-
FGAQPS1000LAE			1000	238	10	-

OF 1024

● G 3/8

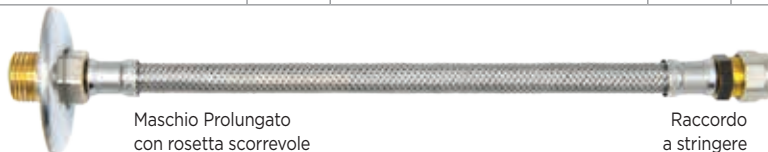

● G 3/8 Ø 10 mm

Maschio Prolungato
con rosetta scorrevole

Raccordo
a stringere

CODICE	RACCORDI	DN	LUNGHEZZA mm			
FGAQQS0200LAR	Maschio Prolungato con rosetta scorrevole G 3/8 Raccordo a stringere G 3/8 Ø 10 mm	10	200	105	-	25
FGAQQS0250LAR			250	113	-	25
FGAQQS0300LAR			300	120	-	25
FGAQQS0350LAR			350	128	-	25
FGAQQS0400LAS			400	135	10	-
FGAQQS0500LAS			500	150	10	-
FGAQQS0600LAS			600	165	10	-
FGAQQS0800LAS			800	196	10	-
FGAQQS1000LAS			1000	226	10	-

OF 1025

● G 1/2

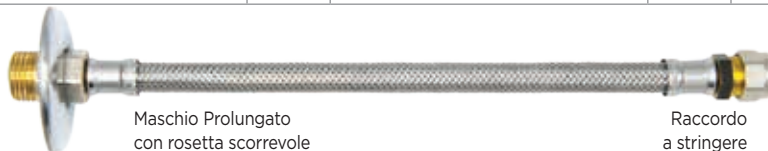

● G 3/8 Ø 10 mm

Maschio Prolungato
con rosetta scorrevole

Raccordo
a stringere

CODICE	RACCORDI	DN	LUNGHEZZA mm			
FGAQPS0200LAR	Maschio Prolungato con rosetta scorrevole G 1/2 Raccordo a stringere G 3/8 Ø 10 mm	10	200	126	-	25
FGAQPS0250LAR			250	133	-	25
FGAQPS0300LAR			300	141	-	25
FGAQPS0350LAR			350	148	-	25
FGAQPS0400LAS			400	156	10	-
FGAQPS0500LAS			500	171	10	-
FGAQPS0600LAS			600	186	10	-
FGAQPS0800LAS			800	216	10	-
FGAQPS1000LAS			1000	246	10	-



DN
10



Max temperatura
70 °C



Max pressione
10 bar



Portata a 3 bar
46 l/min



Raggio min. di curvatura
56 mm



Tubo interno
EPDM



Treccia
INOX AISI 304



Raccordi
CW617N



Istruzioni
Pag. 444



LUXOR®

TUBI FLESSIBILI BAGNO

1.6 / W-FLEX

W-FLEX

CABINE DOCCIA E IDROMASSAGGIO



Dotati di treccia esterna in acciaio inossidabile, raccordi di ottone e bussole in acciaio inossidabile, sono utilizzati prevalentemente per il collegamento tra la rete idrica e pareti

doccia attrezzate o vasche idromassaggio. Ideali per il montaggio da parte dell'installatore grazie al maschio girevole in dotazione.

CARATTERISTICHE TECNICHE



DN

8
10



Max temperatura

70 °C



Max pressione

10 bar



Portata a 3 bar

28 l/min
46 l/min



Raggio min.
di curvatura
48 mm
56 mm



Tubo interno

EPDM



Treccia

INOX AISI
304



Raccordi

CW617N

CAMPI DI APPLICAZIONE



cabine doccia



vasche idromassaggio

TUBO INTERNO

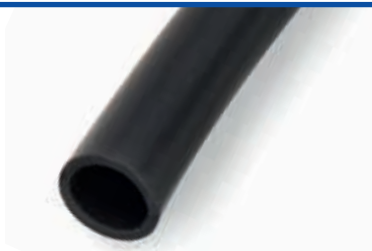

EPDM

La gomma EPDM perossidica è il materiale più utilizzato per la realizzazione del tubo interno.

Con diverse composizioni chimiche, ha proprietà igieniche e meccaniche di alto livello, unitamente ad un'assoluta resistenza all'ossidazione, agli agenti atmosferici ed alle alte temperature.

TIPOLOGIA DI RACCORDI

Maschio Girevole
G 1/2



Femmina con guarnizione inserita
G 1/2



Femmina Curva con guarnizione inserita
G 1/2



CERTIFICAZIONI

EN 13618
UE



Istruzioni
Pag. 444

Per informazioni sulle specifiche tecniche e sui prodotti certificati si prega di rivolgersi ai nostri uffici o visitare il sito web degli enti di certificazione corrispondenti.

WF 801



● G 1/2



● G 1/2

Maschio Girevole

Femmina con guarnizione inserita

CODICE	RACCORDI	DN	LUNGHEZZA mm			
CGGCMS0600LAE	Maschio Girevole G 1/2	8	600	206	10	-
CGGCMS0800LAE			800	249	10	-
CGGCMS1000LAE	Femmina con guarnizione inserita G 1/2		1000	292	10	-
CGGCMS1200LAN	1200		335	-	10	
CGGCMS1500LAN	1500		399	-	10	

WF 1001



● G 1/2



● G 1/2

Maschio Girevole

Femmina con guarnizione inserita

CODICE	RACCORDI	DN	LUNGHEZZA mm			
FGGCMS0600LAE	Maschio Girevole G 1/2	10	600	160	10	-
FGGCMS0800LAE			800	190	10	-
FGGCMS1000LAE	Femmina con guarnizione inserita G 1/2		1000	219	10	-
FGGCMS1200LAN	1200		248	-	10	
FGGCMS1500LAN	1500		293	-	10	

**MASCHIO GIREVOLE**

Il maschio girevole permette al tubo flessibile di ruotare liberamente dopo l'installazione.

Elimina i problemi di torsione e permette montaggi e destinazioni d'uso particolari.



DN
8
10



Max temperatura
70 °C



Max pressione
10 bar



Portata a 3 bar
28 l/min
46 l/min



Raggio min. di curvatura
48 mm
56 mm



Tubo interno
EPDM



Treccia
INOX AISI 304



Raccordi
CW617N



Istruzioni
Pag. 444

WF 802

● G 1/2



● G 1/2

Maschio Girevole

Femmina Curva con guarnizione inserita

CODICE	RACCORDI	DN	LUNGHEZZA mm			
CGGESS0600LAE	Maschio Girevole G 1/2	8	600	207	10	-
CGGESS0800LAE			800	250	10	-
CGGESS1000LAE	Femmina Curva con guarnizione inserita G 1/2		1000	293	10	-
CGGESS1200LAN			1200	336	-	10
CGGESS1500LAN			1500	400	-	10

WF 1002

● G 1/2



● G 1/2

Maschio Girevole

Femmina Curva con guarnizione inserita

CODICE	RACCORDI	DN	LUNGHEZZA mm			
FGGESS0600LAE	Maschio Girevole G 1/2	10	600	178	10	-
FGGESS0800LAE			800	207	10	-
FGGESS1000LAE	Femmina Curva con guarnizione inserita G 1/2		1000	237	10	-
FGGESS1200LAN			1200	266	-	10
FGGESS1500LAN			1500	310	-	10



MASCHIO GIREVOLE

Il maschio girevole permette al tubo flessibile di ruotare liberamente dopo l'installazione.

Elimina i problemi di torsione e permette montaggi e destinazioni d'uso particolari.



DN
8
10



Max temperatura
70 °C



Max pressione
10 bar



Portata a 3 bar
28 l/min
46 l/min



Raggio min. di curvatura
48 mm
56 mm



Tubo interno
EPDM



Treccia
INOX AISI 304



Raccordi
CW617N



Istruzioni
Pag. 444



LUXOR®

TUBI FLESSIBILI BAGNO

1.7 / SHOWER FLEX

SHOWER FLEX

FLESSIBILE PER DOCCIA



Il tubo in PVC ideale per ogni doccia, esteticamente perfetto e con una ghiera girevole per facilitarne l'utilizzo.

CARATTERISTICHE TECNICHE



DN

10



Max temperatura

60 °C



Max pressione

5 bar



Portata a 3 bar

46 l/min

Raggio min.
di curvatura
56 mm

Tubo interno

PVC



Treccia

-



Raccordi

CW617N

CAMPI DI APPLICAZIONE



cabine doccia

TIPOLOGIA DI RACCORDI

**Ghiera Conica
girevole**
G 1/2



**Ghiera
Zigrinata**
G 1/2



**Ghiera
Conica**
G 1/2



Istruzioni
Pag. 444

Per informazioni sulle specifiche tecniche e sui prodotti certificati si prega di rivolgersi ai nostri uffici o visitare il sito web degli enti di certificazione corrispondenti.

SF 8506

● G 1/2 Ghiera Conica girevole  Ghiera Zigrinata ● G 1/2

CODICE	RACCORDI	DN	MATERIALE	LUNGHEZZA mm			
85061500	Ghiera Conica girevole G 1/2	10	PVC cromato	1500	206	-	10
85062000	Ghiera Zigrinata G 1/2			2000	249	-	10

SF 8508

● G 1/2 Ghiera Conica girevole  Ghiera Zigrinata ● G 1/2

CODICE	RACCORDI	DN	MATERIALE	LUNGHEZZA mm			
85081500	Ghiera Conica girevole G 1/2	10	PVC classic	1500	206	-	10
85082000	Ghiera Zigrinata G 1/2			2000	249	-	10

SF 8507

● G 1/2 Ghiera Conica girevole  Cromato  Nero Ghiera Conica ● G 1/2

CODICE	RACCORDI	DN	MATERIALE	LUNGHEZZA mm			
85071500	Ghiera Conica girevole G 1/2	10	PVC cromato	1500	296	-	10
85072000	Ghiera Conica G 1/2			2000	339	-	10
85071500N	Ghiera Conica girevole G 1/2	10	PVC nero	1500	296	-	10
85072000N	Ghiera Conica G 1/2			2000	339	-	10



DN
10



Max temperatura
60 °C



Max pressione
5 bar



Portata a 3 bar
46 l/min



Raggio min. di curvatura
56 mm



Tubo interno
PVC



Treccia
-



Raccordi
CW617N



Istruzioni
Pag. 444



LUXOR®

TUBI FLESSIBILI BAGNO

1.8 / OMNYFLEX 13

OMNYFLEX 13

APPLICAZIONI GENERICHE



Il tubo tradizionale e versatile con interno in EPDM per applicazioni sanitarie che richiedono una portata maggiore.

CARATTERISTICHE TECNICHE



DN

13



Max temperatura

70 °C



Max pressione

10 bar



Portata a 3 bar

74 l/min



Raggio min. di curvatura
72 mm



Tubo interno

EPDM



Treccia

INOX AISI 304



Raccordi

CW617N

CAMPI DI APPLICAZIONE

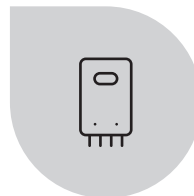

scaldabagni



cabine doccia



vasche idromassaggio

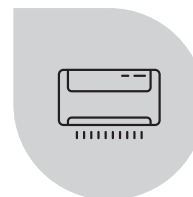

fan coil

TUBO INTERNO

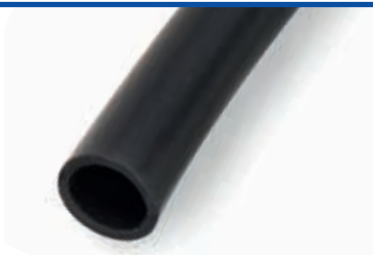

EPDM

La gomma EPDM perossidica è il materiale più utilizzato per la realizzazione del tubo interno.

Con diverse composizioni chimiche, ha proprietà igieniche e meccaniche di alto livello, unitamente ad un'assoluta resistenza all'ossidazione, agli agenti atmosferici ed alle alte temperature.

TIPOLOGIA DI RACCORDI

Maschio

G 1/2
G 3/4



Maschio Prolungato

G 1/2 - 28 mm



Femmina con guarnizione inserita

G 1/2
G 3/4



Femmina Curva con guarnizione inserita

G 1/2
G 3/4



Maschio Prolungato con rosetta scorrevole

G 1/2 - 28 mm



CERTIFICAZIONI

EN 13618

UE



Istruzioni
Pag. 444

Per informazioni sulle specifiche tecniche e sui prodotti certificati si prega di rivolgersi ai nostri uffici o visitare il sito web degli enti di certificazione corrispondenti.

OF 1301

● G 1/2



● G 1/2

Maschio

Femmina con guarnizione inserita

CODICE	RACCORDI	DN	LUNGHEZZA mm			
MGAASS0200LAL	Maschio G 1/2 Femmina con guarnizione inserita G 1/2	13	200	115	-	25
MGAASS0250LAL			250	128	-	25
MGAASS0300LAL			300	141	-	25
MGAASS0350LAL			350	153	-	25
MGAASS0400LAE			400	166	10	-
MGAASS0500LAE			500	191	10	-
MGAASS0600LAE			600	216	10	-
MGAASS0800LAE			800	266	10	-
MGAASS1000LAE			1000	317	10	-

OF 1302

● G 1/2



● G 3/4

Maschio

Femmina con guarnizione inserita

CODICE	RACCORDI	DN	LUNGHEZZA mm			
MGA AUS0200LAL	Maschio G 1/2 Femmina con guarnizione inserita G 3/4	13	200	133	-	20
MGA AUS0250LAL			250	145	-	20
MGA AUS0300LAL			300	158	-	20
MGA AUS0350LAL			350	171	-	20
MGA AUS0400LAE			400	183	10	-
MGA AUS0500LAE			500	208	10	-
MGA AUS0600LAE			600	233	10	-
MGA AUS0800LAE			800	284	10	-
MGA AUS1000LAE			1000	334	10	-

OF 1303

● G 3/4



● G 1/2

Maschio

Femmina con guarnizione inserita

CODICE	RACCORDI	DN	LUNGHEZZA mm			
MGACBS0200LAL	Maschio G 3/4 Femmina con guarnizione inserita G 1/2	13	200	132	-	20
MGACBS0250LAL			250	145	-	20
MGACBS0300LAL			300	157	-	20
MGACBS0350LAL			350	170	-	20
MGACBS0400LAE			400	183	10	-
MGACBS0500LAE			500	208	10	-
MGACBS0600LAE			600	233	10	-
MGACBS0800LAE			800	283	10	-
MGACBS1000LAE			1000	333	10	-

OF 1304

● G 3/4



● G 3/4

Maschio

Femmina con guarnizione inserita

CODICE	RACCORDI	DN	LUNGHEZZA mm			
MGAE7S0200LAL	Maschio G 3/4 Femmina con guarnizione inserita G 3/4	13	200	150	-	20
MGAE7S0250LAL			250	162	-	20
MGAE7S0300LAL			300	175	-	20
MGAE7S0350LAL			350	187	-	20
MGAE7S0400LAE			400	200	10	-
MGAE7S0500LAE			500	225	10	-
MGAE7S0600LAE			600	250	10	-
MGAE7S0800LAE			800	300	10	-
MGAE7S1000LAE			1000	351	10	-



DN
13



Max temperatura
70 °C



Max pressione
10 bar



Portata a 3 bar
74 l/min



Raggio min. di curvatura
72 mm



Tubo interno
EPDM



Treccia
INOX AISI 304



Raccordi
CW617N



Istruzioni
Pag. 444

OF 1305

● G 1/2



● G 1/2

Femmina con guarnizione inserita

Femmina con guarnizione inserita

CODICE	RACCORDI	DN	LUNGHEZZA mm			
MGAGKS0200LAL	Femmina con guarnizione inserita G 1/2	13	200	110	-	25
MGAGKS0250LAL			250	123	-	25
MGAGKS0300LAL			300	136	-	25
MGAGKS0350LAL			350	148	-	25
MGAGKS0400LAE			400	161	10	-
MGAGKS0500LAE	Femmina con guarnizione inserita G 1/2	13	500	186	10	-
MGAGKS0600LAE			600	211	10	-
MGAGKS0800LAE			800	261	10	-
MGAGKS1000LAE			1000	312	10	-

OF 1306

● G 1/2



● G 3/4

Femmina con guarnizione inserita

Femmina con guarnizione inserita

CODICE	RACCORDI	DN	LUNGHEZZA mm			
MGAGMS0200LAL	Femmina con guarnizione inserita G 1/2	13	200	134	-	20
MGAGMS0250LAL			250	146	-	20
MGAGMS0300LAL			300	159	-	20
MGAGMS0350LAL			350	171	-	20
MGAGMS0400LAE			400	184	10	-
MGAGMS0500LAE	Femmina con guarnizione inserita G 3/4	13	500	209	10	-
MGAGMS0600LAE			600	234	10	-
MGAGMS0800LAE			800	285	10	-
MGAGMS1000LAE			1000	335	10	-

OF 1307

● G 3/4



● G 3/4

Femmina con guarnizione inserita

Femmina con guarnizione inserita

CODICE	RACCORDI	DN	LUNGHEZZA mm			
MGAGRS0200LAL	Femmina con guarnizione inserita G 3/4	13	200	145	-	20
MGAGRS0250LAL			250	157	-	20
MGAGRS0300LAL			300	170	-	20
MGAGRS0350LAL			350	183	-	20
MGAGRS0400LAE			400	195	10	-
MGAGRS0500LAE	Femmina con guarnizione inserita G 3/4	13	500	220	10	-
MGAGRS0600LAE			600	246	10	-
MGAGRS0800LAE			800	296	10	-
MGAGRS1000LAE			1000	346	10	-



DN
13



Max temperatura
70 °C



Max pressione
10 bar



Portata a 3 bar
74 l/min



Raggio min. di curvatura
72 mm



Tubo interno
EPDM



Treccia
INOX AISI 304



Raccordi
CW617N



Istruzioni
Pag. 444

OF 1308

● G 1/2



Maschio

Femmina Curva con
guarnizione inserita

● G 1/2

CODICE	RACCORDI	DN	LUNGHEZZA mm			
MGAD3S0200LAL	Maschio G 1/2 Femmina Curva con guarnizione inserita G 1/2	13	200	129	-	20
MGAD3S0250LAL			250	141	-	20
MGAD3S0300LAL			300	154	-	20
MGAD3S0350LAL			350	167	-	20
MGAD3S0400LAE			400	179	10	-
MGAD3S0500LAE			500	204	10	-
MGAD3S0600LAE			600	230	10	-
MGAD3S0800LAE			800	280	10	-
MGAD3S1000LAE			1000	330	10	-

OF 1309

● G 1/2



Maschio

Femmina Curva con
guarnizione inserita

● G 3/4

CODICE	RACCORDI	DN	LUNGHEZZA mm			
MGAE2S0200LAL	Maschio G 1/2 Femmina Curva con guarnizione inserita G 3/4	13	200	147	-	20
MGAE2S0250LAL			250	172	-	20
MGAE2S0300LAL			300	185	-	20
MGAE2S0350LAL			350	197	-	20
MGAE2S0400LAE			400	222	10	-
MGAE2S0500LAE			500	248	10	-
MGAE2S0600LAE			600	298	10	-
MGAE2S0800LAE			800	348	10	-
MGAE2S1000LAE			1000	334	10	-

OF 1310

● G 3/4



Maschio

Femmina Curva con
guarnizione inserita

● G 3/4

CODICE	RACCORDI	DN	LUNGHEZZA mm			
MGAE1S0200LAL	Maschio G 3/4 Femmina Curva con guarnizione inserita G 3/4	13	200	158	-	20
MGAE1S0250LAL			250	171	-	20
MGAE1S0300LAL			300	183	-	20
MGAE1S0350LAL			350	196	-	20
MGAE1S0400LAE			400	208	10	-
MGAE1S0500LAE			500	233	10	-
MGAE1S0600LAE			600	258	10	-
MGAE1S0800LAE			800	308	10	-
MGAE1S1000LAE			1000	358	10	-



DN
13



Max temperatura
70 °C



Max pressione
10 bar



Portata a 3 bar
74 l/min



Raggio min. di curvatura
72 mm



Tubo interno
EPDM



Trecia
INOX AISI 304



Raccordi
CW617N



Istruzioni
Pag. 444

OF 1311

● G 1/2



● G 1/2

Maschio Prolungato

Femmina con guarnizione inserita

CODICE	RACCORDI	DN	LUNGHEZZA mm			
MGADDS0200LAL	Maschio Prolungato G 1/2 Femmina con guarnizione inserita G 1/2	13	200	135	-	25
MGADDS0250LAL			250	147	-	25
MGADDS0300LAL			300	160	-	25
MGADDS0350LAL			350	173	-	25
MGADDS0400LAE			400	185	10	-
MGADDS0500LAE			500	210	10	-
MGADDS0600LAE			600	235	10	-
MGADDS0800LAE			800	286	10	-
MGADDS1000LAE			1000	336	10	-

OF 1312

● G 1/2



● G 1/2

Maschio Prolungato
con rosetta scorrevole

Femmina con
guarnizione inserita

CODICE	RACCORDI	DN	LUNGHEZZA mm			
MGADDS0200LAR	Maschio Prolungato con rosetta scorrevole G 1/2 Femmina con guarnizione inserita G 1/2	13	200	143	-	25
MGADDS0250LAR			250	155	-	25
MGADDS0300LAR			300	168	-	25
MGADDS0350LAR			350	181	-	25
MGADDS0400LAS			400	193	10	-
MGADDS0500LAS			500	218	10	-
MGADDS0600LAS			600	243	10	-
MGADDS0800LAS			800	294	10	-
MGADDS1000LAS			1000	344	10	-



DN
13



Max temperatura
70 °C



Max pressione
10 bar



Portata a 3 bar
74 l/min



Raggio min. di curvatura
72 mm



Tubo interno
EPDM



Treccia
INOX AISI 304



Raccordi
CW617N



Istruzioni
Pag. 444



LUXOR®

TUBI FLESSIBILI CUCINA

2.1 / K-FLEX

K-FLEX

IDEALE PER DOCCETTA CUCINA



Ideale per il collegamento di doccette estraibili pull-out / pull-down utilizzabile per rubinetti da cucina. La misura standard è il DN8 con treccia in nylon PA6.6, disponibile nei

colori grigio, nero e bianco.
Raccordi in ottone e bussole in acciaio inossidabile.

CARATTERISTICHE TECNICHE



DN

8



Max temperatura

70 °C



Max pressione

10 bar



Portata a 3 bar

28 l/min

Raggio min.
di curvatura
48 mm

Tubo interno

EPDM



Treccia

NYLON PA
6.6

Raccordi

CW617N

CAMPI DI APPLICAZIONE

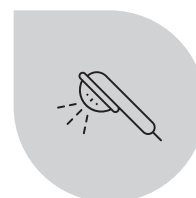

doccetta cucina

TUBO INTERNO

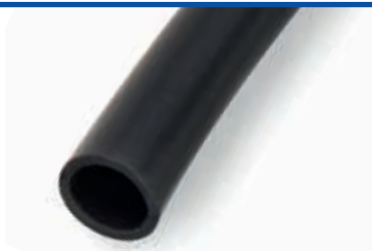

EPDM

La gomma EPDM perossidica è il materiale più utilizzato per la realizzazione del tubo interno.

Con diverse composizioni chimiche, ha proprietà igieniche e meccaniche di alto livello, unitamente ad un'assoluta resistenza all'ossidazione, agli agenti atmosferici ed alle alte temperature.

TIPOLOGIA DI RACCORDI

**Maschio
Girevole**
M 15x1



**Ghiera Conica
con o-ring e
contrappeso**
G 1/2



CERTIFICAZIONI

EN 13618
UE



Istruzioni
Pag. 444

Per informazioni sulle specifiche tecniche e sui prodotti certificati si prega di rivolgersi ai nostri uffici o visitare il sito web degli enti di certificazione corrispondenti.

KF 801

● M 15x1



● G 1/2

Maschio Girevole

Ghiera Conica con o-ring e contrappeso

CODICE	RACCORDI	DN	COLORE TRECCIA	LUNGHEZZA mm			
CPACTF1200LAG	Maschio Girevole M 15x1	8	Nylon nero	1200	365	1	50
CPACTF1500LAG	Ghiera Conica con o-ring e contrappeso G 1/2			1500	388	1	50

KF 802

● M 15x1



● G 1/2

Maschio Girevole

Ghiera Conica con o-ring e contrappeso

CODICE	RACCORDI	DN	COLORE TRECCIA	LUNGHEZZA mm			
CLACTF1200LAG	Maschio Girevole M 15x1	8	Nylon grigio	1200	365	1	50
CLACTF1500LAG	Ghiera Conica con o-ring e contrappeso G 1/2			1500	388	1	50

KF 803

● M 15x1



● G 1/2

Maschio Girevole

Ghiera Conica con o-ring e contrappeso

CODICE	RACCORDI	DN	COLORE TRECCIA	LUNGHEZZA mm			
CNACTF1200LAG	Maschio Girevole M 15x1	8	Nylon bianco	1200	365	1	50
CNACTF1500LAG	Ghiera Conica con o-ring e contrappeso G 1/2			1500	388	1	50



DN
8



Max temperatura
70 °C



Max pressione
10 bar



Portata a 3 bar
28 l/min



Raggio min. di curvatura
48 mm



Tubo interno
EPDM



Treccia
NYLON PA 6.6



Raccordi
CW617N



Istruzioni
Pag. 444



LUXOR®

TUBI FLESSIBILI CUCINA

2.2 / FLEXY MIX

FLEXY MIX

IDEALE PER RUBINETTERIA



Con la combinazione tra la treccia in inox e il tubo interno in EPDM, permette un collegamento flessibile e semplice tra la rete di approvvigionamento idrico e rubinetti di qualsiasi

tipo. Riconosciuto per il suo alto livello di qualità, è un prodotto in conformità ai requisiti internazionali del settore.

CARATTERISTICHE TECNICHE



DN

8



Max temperatura

70 °C



Max pressione

10 bar



Portata a 3 bar

28 l/min

Raggio min.
di curvatura
48 mm

Tubo interno

EPDM



Treccia

INOX AISI
304

Raccordi

CW617N

CAMPI DI APPLICAZIONE

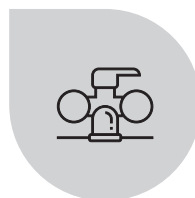

rubinetto tradizionale



rubinetti miscelatori

TUBO INTERNO

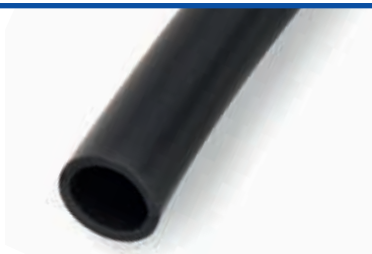

EPDM

La gomma EPDM perossidica è il materiale più utilizzato per la realizzazione del tubo interno.

Con diverse composizioni chimiche, ha proprietà igieniche e meccaniche di alto livello, unitamente ad un'assoluta resistenza all'ossidazione, agli agenti atmosferici ed alle alte temperature.

TIPOLOGIA DI RACCORDI

Maschio corto
M 10x1 - 18 mm



Maschio medio
M 10x1 - 46 mm



**Femmina con
guarnizione
inserita**
G 3/8
G 1/2



**Astina
con scalino**
Ø 10 mm



**Raccordo
a stringere**
G 3/8 Ø 10 mm



CERTIFICAZIONI

EN 13618
UE



Istruzioni
Pag. 444

Per informazioni sulle specifiche tecniche e sui prodotti certificati si prega di rivolgersi ai nostri uffici o visitare il sito web degli enti di certificazione corrispondenti.

FX 801



● M 10x1



● G 3/8

Maschio Corto

Femmina con guarnizione inserita

CODICE	RACCORDI	DN	LUNGHEZZA mm			
CGAKLS0200LAL	Maschio Corto M 10x1 Femmina con guarnizione inserita G 3/8	8	200	63	-	25
CGAKLS0250LAL			250	70	-	25
CGAKLS0300LAL			300	76	-	25
CGAKLS0350LAL			350	83	-	25
CGAKLS0400LAE			400	90	10	-
CGAKLS0500LAE			500	104	10	-
CGAKLS0600LAE			600	117	10	-

FX 802



● M 10x1



● G 1/2

Maschio Corto

Femmina con guarnizione inserita

CODICE	RACCORDI	DN	LUNGHEZZA mm			
CGAKJS0200LAL	Maschio Corto M 10x1 Femmina con guarnizione inserita G 1/2	8	200	78	-	25
CGAKJS0250LAL			250	85	-	25
CGAKJS0300LAL			300	92	-	25
CGAKJS0350LAL			350	99	-	25
CGAKJS0400LAE			400	106	10	-
CGAKJS0500LAE			500	119	10	-
CGAKJS0600LAE			600	133	10	-

FX 803



● M 10x1



● G 3/8

Maschio Medio

Femmina con guarnizione inserita

CODICE	RACCORDI	DN	LUNGHEZZA mm			
CGASES0200LAL	Maschio Medio M 10x1 Femmina con guarnizione inserita G 3/8	8	200	69	-	25
CGASES0250LAL			250	76	-	25
CGASES0300LAL			300	83	-	25
CGASES0350LAL			350	90	-	25
CGASES0400LAE			400	96	10	-
CGASES0500LAE			500	110	10	-
CGASES0600LAE			600	124	10	-

FX 804



● M 10x1



● G 1/2

Maschio Medio

Femmina con guarnizione inserita

CODICE	RACCORDI	DN	LUNGHEZZA mm			
CGASDS0200LAL	Maschio Medio M 10x1 Femmina con guarnizione inserita G 1/2	8	200	85	-	25
CGASDS0250LAL			250	92	-	25
CGASDS0300LAL			300	98	-	25
CGASDS0350LAL			350	105	-	25
CGASDS0400LAE			400	112	10	-
CGASDS0500LAE			500	126	10	-
CGASDS0600LAE			600	139	10	-

DN
8Max temperatura
70 °CMax pressione
10 barPortata a 3 bar
28 l/minRaggio min. di curvatura
48 mmTubo interno
EPDMTreccia
INOX AISI 304Raccordi
CW617NIstruzioni
Pag. 444

FX 805



● ø 10 mm



● G 3/8 Ø 10 mm

Astina con scalino

Raccordo a stringere

CODICE	RACCORDI	DN	LUNGHEZZA mm			
CGA3GS0200LAL	Astina con scalino ø 10 mm Raccordo a stringere G 3/8 ø 10 mm	8	200	75	-	25
CGA3GS0250LAL			250	82	-	25
CGA3GS0300LAL			300	89	-	25
CGA3GS0350LAL			350	96	-	25
CGA3GS0400LAE			400	102	10	-
CGA3GS0500LAE			500	116	10	-
CGA3GS0600LAE			600	130	10	-



DN

8



Max temperatura

70 °C



Max pressione

10 bar



Portata a 3 bar

28 l/min



Raggio min. di curvatura

48 mm



Tubo interno

EPDM



Treccia

INOX AISI 304



Raccordi

CW617N



Istruzioni

Pag. 444



LUXOR®

TUBI FLESSIBILI CUCINA

2.3 / FLEXY MIX PT+

FLEXY MIX PT+

SPECIALE RUBINETTERIA IN SILICONE



L'inliner in Silicone Platinico conferisce ai tubi flessibili eccellenti proprietà igieniche nonché un'elevata resistenza alla pressione e alla temperatura è quindi particolarmente

indicato per ambienti con requisiti igienici rigorosi come per esempio strutture sanitarie.

CARATTERISTICHE TECNICHE



DN

8



Max temperatura

70 °C



Max pressione

10 bar



Portata a 3 bar

28 l/min

Raggio min.
di curvatura
48 mm

Tubo interno

SILICONE



Treccia

INOX AISI
304

Raccordi

CW617N

CAMPI DI APPLICAZIONE

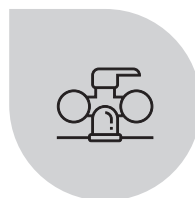

rubinetto tradizionale



rubinetti miscelatori

TUBO INTERNO



SILICONE

Il silicone platinico, materiale pregiato di altissima qualità, sta raccogliendo sempre più consenso sui mercati idrosanitari internazionali.

Questa è la versione più pura disponibile sul mercato e capace di garantire la piena alimentariet  del prodotto. Alcune delle caratteristiche peculiari sono il mantenimento di un'ottima elasticit  e delle propriet  meccaniche per tutto il range di temperatura di servizio.

TIPOLOGIA DI RACCORDI

Maschio corto
M 10x1 - 18 mm



Maschio medio
M 10x1 - 46 mm



**Femmina con
guarnizione
inserita**
G 3/8
G 1/2



DM 174
Italia



EN 13618
UE



DVGW
Germania



Istruzioni
Pag. 444

Per informazioni sulle specifiche tecniche e sui prodotti certificati si prega di rivolgersi ai nostri uffici o visitare il sito web degli enti di certificazione corrispondenti.

FP 801

● M 10x1



● G 3/8

Maschio Corto

Femmina con guarnizione inserita

CODICE	RACCORDI	DN	LUNGHEZZA mm			
CHQKLS0200DML	Maschio Corto M 10x1 Femmina con guarnizione inserita G 3/8	8	200	58	-	25
CHQKLS0250DML			250	65	-	25
CHQKLS0300DML			300	71	-	25
CHQKLS0350DML			350	77	-	25
CHQKLS0400DME			400	84	10	-
CHQKLS0500DME			500	96	10	-
CHQKLS0600DME			600	109	10	-

FP 802

● M 10x1



● G 1/2

Maschio Corto

Femmina con guarnizione inserita

CODICE	RACCORDI	DN	LUNGHEZZA mm			
CHQKJS0200DML	Maschio Corto M 10x1 Femmina con guarnizione inserita G 1/2	8	200	62	-	25
CHQKJS0250DML			250	69	-	25
CHQKJS0300DML			300	75	-	25
CHQKJS0350DML			350	81	-	25
CHQKJS0400DME			400	88	10	-
CHQKJS0500DME			500	100	10	-
CHQKJS0600DME			600	113	10	-

FP 803

● M 10x1



● G 3/8

Maschio Medio

Femmina con guarnizione inserita

CODICE	RACCORDI	DN	LUNGHEZZA mm			
CHQSES0200DML	Maschio Medio M 10x1 Femmina con guarnizione inserita G 3/8	8	200	66	-	25
CHQSES0250DML			250	72	-	25
CHQSES0300DML			300	79	-	25
CHQSES0350DML			350	85	-	25
CHQSES0400DME			400	91	10	-
CHQSES0500DME			500	104	10	-
CHQSES0600DME			600	116	10	-

FP 804

● M 10x1



● G 1/2

Maschio Medio

Femmina con guarnizione inserita

CODICE	RACCORDI	DN	LUNGHEZZA mm			
CHQSDS0200DML	Maschio Medio M 10x1 Femmina con guarnizione inserita G 1/2	8	200	70	-	25
CHQSDS0250DML			250	76	-	25
CHQSDS0300DML			300	83	-	25
CHQSDS0350DML			350	89	-	25
CHQSDS0400DME			400	95	10	-
CHQSDS0500DME			500	108	10	-
CHQSDS0600DME			600	120	10	-



DN
8



Max temperatura
70 °C



Max pressione
10 bar



Portata a 3 bar
28 l/min



Raggio min. di curvatura
48 mm



Tubo interno
SILICONE



Treccia
INOX AISI 304



Raccordi
CW617N



Istruzioni
Pag. 444



A series of horizontal lines for writing, consisting of 25 evenly spaced lines across the page.



LUXOR®

TUBI FLESSIBILI CARICO ELETTRODOMESTICI

3.1 / E-FLEX INOX

E-FLEX INOX

PER ELETTRODOMESTICI



Tubo per collegamento elettrodomestici nei diametri DN8, DN10 e DN13. La treccia esterna in inox garantisce durezza e resistenza agli agenti esterni, mantenendo una discreta flessibilità nonché un'elevata resistenza alla pressione

e alla temperatura, ideale per acqua calda. Disponibile con treccia e bussola in acciaio inossidabile e raccorderia in ottone.

CARATTERISTICHE TECNICHE



DN

8
10
13

Raggio min.
di curvatura
48 mm
56 mm
72 mm



Max temperatura

70 °C



Tubo interno

EPDM



Max pressione

10 bar



Treccia

INOX AISI
304

Portata a 3 bar

28 l/min
46 l/min
74 l/min

Raccordi

CW617N

CAMPI DI APPLICAZIONE



lavatrici



lavastoviglie

TUBO INTERNO

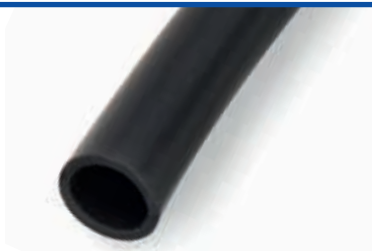

EPDM

La gomma EPDM perossidica è il materiale più utilizzato per la realizzazione del tubo interno.

Con diverse composizioni chimiche, ha proprietà igieniche e meccaniche di alto livello, unitamente ad un'assoluta resistenza all'ossidazione, agli agenti atmosferici ed alle alte temperature.

TIPOLOGIA DI RACCORDI

Femmina con
guarnizione
inserita
G 3/4



Femmina Curva
con guarnizione
inserita
G 3/4



CERTIFICAZIONI

EN 13618
UE



Istruzioni
Pag. 444

Per informazioni sulle specifiche tecniche e sui prodotti certificati si prega di rivolgersi ai nostri uffici o visitare il sito web degli enti di certificazione corrispondenti.

EFI 801

● G 3/4



● G 3/4

Femmina con guarnizione inserita

Femmina con guarnizione inserita

CODICE	RACCORDI	DN	LUNGHEZZA mm			
CGGGRS1000LAN	Femmina con guarnizione inserita G 3/4	8	1000	228	-	10
CGGGRS1500LAN			1500	290	-	10
CGGGRS2000LAN			2000	352	-	10
CGGGRS2500LAN	Femmina con guarnizione inserita G 3/4	8	2500	415	-	10
CGGGRS3000LAN			3000	477	-	10

EFI 1001

● G 3/4



● G 3/4

Femmina con guarnizione inserita

Femmina con guarnizione inserita

CODICE	RACCORDI	DN	LUNGHEZZA mm			
FGGGRS1000LAN	Femmina con guarnizione inserita G 3/4	10	1000	246	-	10
FGGGRS1500LAN			1500	319	-	10
FGGGRS2000LAN			2000	393	-	10
FGGGRS2500LAN	Femmina con guarnizione inserita G 3/4	10	2500	466	-	10
FGGGRS3000LAN			3000	539	-	10

EFI 1301

● G 3/4



● G 3/4

Femmina con guarnizione inserita

Femmina con guarnizione inserita

CODICE	RACCORDI	DN	LUNGHEZZA mm			
MGGGRS1000LAN	Femmina con guarnizione inserita G 3/4	13	1000	350	-	10
MGGGRS1500LAN			1500	472	-	10
MGGGRS2000LAN			2000	594	-	10
MGGGRS2500LAN	Femmina con guarnizione inserita G 3/4	13	2500	717	-	5
MGGGRS3000LAN			3000	839	-	5



DN
8
10
13



Max temperatura
70 °C



Max pressione
10 bar



Portata a 3 bar
28 l/min
46 l/min
74 l/min



Raggio min. di curvatura
48 mm
56 mm
72 mm



Tubo interno
EPDM



Treccia
INOX AISI 304



Raccordi
CW617N



Istruzioni
Pag. 444

EFI 802



● G 3/4



● G 3/4

Femmina con guarnizione inserita

Femmina Curva con guarnizione inserita

CODICE	RACCORDI	DN	LUNGHEZZA mm			
CGGHZS1000LAN	Femmina con guarnizione inserita G 3/4	8	1000	224	-	10
CGGHZS1500LAN			1500	286	-	10
CGGHZS2000LAN	Femmina Curva con guarnizione inserita G 3/4		2000	349	-	10
CGGHZS2500LAN			2500	411	-	10
CGGHZS3000LAN			3000	474	-	10

EFI 1002



● G 3/4



● G 3/4

Femmina con guarnizione inserita

Femmina Curva con guarnizione inserita

CODICE	RACCORDI	DN	LUNGHEZZA mm			
FGGHZS1000LAN	Femmina con guarnizione inserita G 3/4	10	1000	259	-	10
FGGHZS1500LAN			1500	332	-	10
FGGHZS2000LAN	Femmina Curva con guarnizione inserita G 3/4		2000	405	-	10
FGGHZS2500LAN			2500	479	-	10
FGGHZS3000LAN			3000	552	-	10

EFI 1302



● G 3/4



● G 3/4

Femmina con guarnizione inserita

Femmina Curva con guarnizione inserita

CODICE	RACCORDI	DN	LUNGHEZZA mm			
MGGHZS1000LAN	Femmina con guarnizione inserita G 3/4	13	1000	360	-	10
MGGHZS1500LAN			1500	482	-	10
MGGHZS2000LAN	Femmina Curva con guarnizione inserita G 3/4		2000	605	-	10
MGGHZS2500LAN			2500	727	-	5
MGGHZS3000LAN			3000	849	-	5



DN

8
10
13

Max temperatura

70 °C



Max pressione

10 bar



Portata a 3 bar

28 l/min
46 l/min
74 l/min

Raggio min. di curvatura

48 mm
56 mm
72 mm

Tubo interno

EPDM



Treccia

INOX AISI 304



Raccordi

CW617N



Istruzioni

Pag. 444



LUXOR®

TUBI FLESSIBILI CARICO ELETTRODOMESTICI

3.2 / E-FLEX

E-FLEX SENZA TRECCIA



Tubo flessibile in PVC rinforzato per acqua fredda, con raccordi in nylon; disponibile nelle versioni con raccordi in nylon Femmina / Femmina e Femmina / Femmina curva, sempre con guarnizione inserita.

CARATTERISTICHE TECNICHE



DN

10



Max temperatura

30 °C



Max pressione

10 bar



Portata a 3 bar

46 l/min

Raggio min.
di curvatura
60 mm

Tubo interno

PVC



Treccia

-



Raccordi

NYLON PA
6.6

CAMPI DI APPLICAZIONE



lavatrici



lavastoviglie

TIPOLOGIA DI RACCORDI

**Femmina
in nylon con
guarnizione
inserita**
G 3/4



**Femmina Curva
in nylon con
guarnizione
inserita**
G 3/4



Istruzioni
Pag. 444

Per informazioni sulle specifiche tecniche e sui prodotti certificati si prega di rivolgersi ai nostri uffici o visitare il sito web degli enti di certificazione corrispondenti.

EF 1001



Femmina in nylon
con guarnizione inserita

● G 3/4

Femmina in nylon
con guarnizione inserita

● G 3/4

CODICE	RACCORDI	DN	LUNGHEZZA mm			
60108210	Femmina in nylon con guarnizione inserita G 3/4	10	1000	156	-	10
60108215			1500	218	-	10
60108220			2000	288	-	10
60108225	Femmina in nylon con guarnizione inserita G 3/4	10	2500	382	-	5
60108230			3000	420	-	5

EF 1002



Femmina in nylon
con guarnizione inserita

● G 3/4

Femmina Curva in nylon
con guarnizione inserita

● G 3/4

CODICE	RACCORDI	DN	LUNGHEZZA mm			
60108010	Femmina in nylon con guarnizione inserita G 3/4	10	1000	164	-	10
60108015			1500	218	-	10
60108020			2000	290	-	10
60108025	Femmina Curva in nylon con guarnizione inserita G 3/4	10	2500	388	-	5
60108030			3000	420	-	5

EF 1003

Tubi scarico in polypropilene
con curva inclusa.



CODICE	RACCORDI	DN	LUNGHEZZA mm			
60001000	Tubo Ø 19 x 25	10	1000	80	-	10
60001500			1500	102	-	10
60002000			2000	122	-	10
60002500	Manicotti Ø 19 - Ø 21	10	2500	148	-	10
60003000			3000	168	-	10

EF 1004

Guarnizione in gomma EPDM
senza retino.



CODICE	RACCORDI	DN	LUNGHEZZA mm			
60120000CF	G 3/4	10	-	1	100	-



DN
10



Max temperatura
30 °C



Max pressione
10 bar



Portata a 3 bar
46 l/min



Raggio min. di curvatura
60 mm



Tubo interno
PVC



Treccia
-



Raccordi
NYLON PA 6.6



Istruzioni
Pag. 444



LUXOR®

TUBI FLESSIBILI INDUSTRIALI

4.1 / ACFZ-S

ACFZ-S

FLESSIBILI IN ACCIAIO ZINCATO



Per applicazioni industriali dove è necessaria una portata elevata ed una temperatura massima elevata, vengono utiliz-

zati questi flessibili di grandi dimensioni, dal diametro DN15 al DN50.

CARATTERISTICHE TECNICHE



DN

15
18
25
32
40
50



Max temperatura

110 °C



Max pressione

10 bar
10 bar
10 bar
6 bar
6 bar
6 bar



Portata a 3 bar

83 l/min
200 l/min
280 l/min
490 l/min
800 l/min
1300 l/min



Raggio min. di curvatura
80 mm
104 mm
132 mm
168 mm
212 mm
275 mm



Tubo interno

EPDM



Treccia

ACCIAIO ZINCATO



Raccordi

ACCIAIO ZINCATO
o
CW617N ZINCATO

CAMPI DI APPLICAZIONE

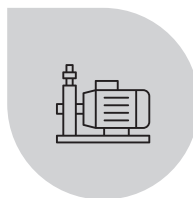

pompe



colonne montanti



impianti di riscaldamento

TUBO INTERNO

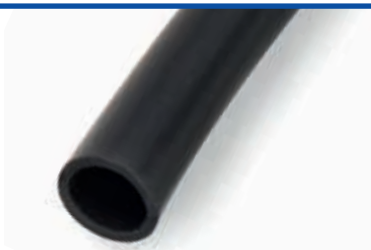

EPDM

La gomma EPDM perossidica è il materiale più utilizzato per la realizzazione del tubo interno.

Con diverse composizioni chimiche, ha proprietà igieniche e meccaniche di alto livello, unitamente ad un'assoluta resistenza all'ossidazione, agli agenti atmosferici ed alle alte temperature.

TIPOLOGIA DI RACCORDI

Maschio

G 1/2
G 3/4
G 1"
G 1" 1/4
G 1" 1/2
G 2"



Femmina

G 1/2
G 3/4
G 1"
G 1" 1/4
G 1" 1/2
G 2"



Femmina Curva

G 1/2
G 3/4
G 1"
G 1" 1/4



Istruzioni
Pag. 444

Per informazioni sulle specifiche tecniche e sui prodotti certificati si prega di rivolgersi ai nostri uffici o visitare il sito web degli enti di certificazione corrispondenti.

AC 1501

● G 1/2

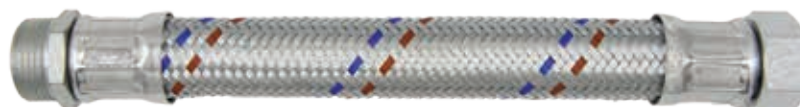

● G 1/2

Maschio

Femmina

CODICE	RACCORDI	DN	LUNGHEZZA mm			
QZMANZ0300LAE	Maschio G 1/2 Femmina G 1/2	15	300	187	5	-
QZMANZ0400LAE			400	222	5	-
QZMANZ0500LAE			500	257	5	-
QZMANZ0600LAE			600	291	5	-
QZMANZ0700LAE			700	326	5	-
QZMANZ0800LAE			800	360	5	-
QZMANZ1000LAE			1000	430	5	-

AC 1801

● G 3/4

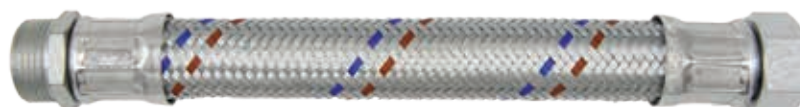

● G 3/4

Maschio

Femmina

CODICE	RACCORDI	DN	LUNGHEZZA mm			
SZMBTG0300LAE	Maschio G 3/4 Femmina G 3/4	18	300	260	5	-
SZMBTG0400LAE			400	312	5	-
SZMBTG0500LAE			500	362	5	-
SZMBTG0600LAE			600	413	5	-
SZMBTG0700LAE			700	464	5	-
SZMBTG0800LAE			800	515	5	-
SZMBTG1000LAE			1000	617	5	-

AC 1802

● G 1"

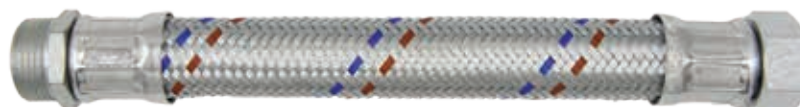

● G 1"

Maschio

Femmina

CODICE	RACCORDI	DN	LUNGHEZZA mm			
SZMABG0300LAE	Maschio G 1" Femmina G 1"	18	300	321	5	-
SZMABG0400LAE			400	371	5	-
SZMABG0500LAE			500	422	5	-
SZMABG0600LAE			600	473	5	-
SZMABG0700LAE			700	524	5	-
SZMABG0800LAE			800	575	5	-
SZMABG1000LAE			1000	677	5	-

AC 2501

● G 1"

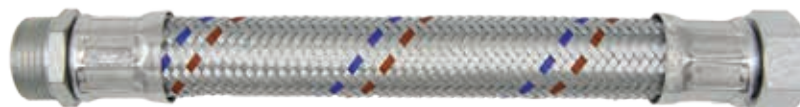

● G 1"

Maschio

Femmina

CODICE	RACCORDI	DN	LUNGHEZZA mm			
TZMABG0300LAE	Maschio G 1" Femmina G 1"	25	300	389	5	-
TZMABG0400LAE			400	459	5	-
TZMABG0500LAE			500	530	5	-
TZMABG0600LAE			600	601	5	-
TZMABG0700LAE			700	672	5	-
TZMABG0800LAE			800	742	5	-
TZMABG1000LAE			1000	884	5	-



DN

15
18
25



Max temperatura

110 °C



Max pressione

10 bar
10 bar
10 bar



Portata a 3 bar

83 l/min
200 l/min
280 l/min



Raggio min. di curvatura

80 mm
104 mm
132 mm



Tubo interno

EPDM



Treccia

ACCIAIO ZINCATO



Raccordi

ACCIAIO ZINCATO
o
CW617N ZINCATO



Istruzioni

Pag. 444

AC 3201

● G 1" 1/4

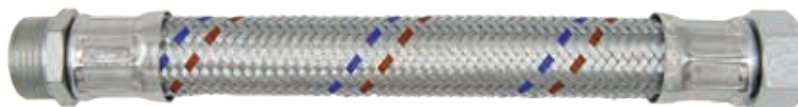

Maschio

Femmina

● G 1" 1/4

CODICE	RACCORDI	DN	LUNGHEZZA mm			
VZMAGG0300LAE	Maschio G 1" 1/4 Femmina G 1" 1/4	32	300	681	2	-
VZMAGG0400LAE			400	789	2	-
VZMAGG0500LAE			500	897	2	-
VZMAGG0600LAE			600	1.005	2	-
VZMAGG0700LAE			700	1.113	2	-
VZMAGG0800LAE			800	1.221	2	-
VZMAGG1000LAE			1000	1.437	2	-

AC 4001

● G 1" 1/2

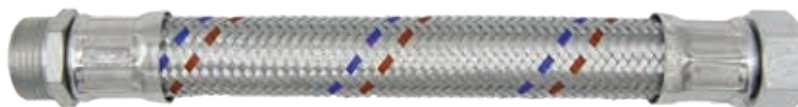

Maschio

Femmina

● G 1" 1/2

CODICE	RACCORDI	DN	LUNGHEZZA mm			
XZMAEB0300LAE	Maschio G 1" 1/2 Femmina G 1" 1/2	40	300	1.097	2	-
XZMAEB0400LAE			400	1.258	2	-
XZMAEB0500LAE			500	1.418	2	-
XZMAEB0600LAE			600	1.579	2	-
XZMAEB0700LAE			700	1.740	2	-
XZMAEB0800LAE			800	1.900	2	-
XZMAEB1000LAE			1000	2.222	2	-

AC 5001

● G 2"

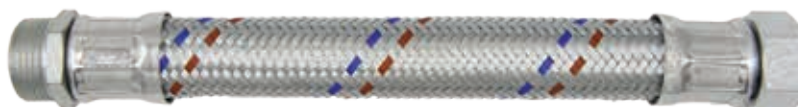

Maschio

Femmina

● G 2"

CODICE	RACCORDI	DN	LUNGHEZZA mm			
ZZMBNB0300LAE	Maschio G 2" Femmina G 2"	50	300	1.553	1	-
ZZMBNB0400LAE			400	1.776	1	-
ZZMBNB0500LAE			500	1.998	1	-
ZZMBNB0600LAE			600	2.221	1	-
ZZMBNB0700LAE			700	2.444	1	-
ZZMBNB0800LAE			800	2.667	1	-
ZZMBNB1000LAE			1000	3.113	1	-



DN
32
40
50



Max temperatura
110 °C



Max pressione
6 bar
6 bar
6 bar



Portata a 3 bar
490 l/min
800 l/min
1300 l/min



Raggio min. di curvatura
168 mm
212 mm
275 mm



Tubo interno
EPDM



Treccia
ACCIAIO ZINCATO



Raccordi
ACCIAIO ZINCATO



Istruzioni
Pag. 444

AC 1502

● G 1/2



● G 1/2

Femmina

Femmina

CODICE	RACCORDI	DN	LUNGHEZZA mm			
QZMFHZ0300LAE	Femmina G 1/2	15	300	183	5	-
QZMFHZ0400LAE			400	218	5	-
QZMFHZ0500LAE			500	253	5	-
QZMFHZ0600LAE			600	287	5	-
QZMFHZ0700LAE			700	322	5	-
QZMFHZ0800LAE			800	356	5	-
QZMFHZ1000LAE			1000	425	5	-

AC 1803

● G 3/4



● G 3/4

Femmina

Femmina

CODICE	RACCORDI	DN	LUNGHEZZA mm			
SZMGCG0300LAE	Femmina G 3/4	18	300	272	5	-
SZMGCG0400LAE			400	323	5	-
SZMGCG0500LAE			500	374	5	-
SZMGCG0600LAE			600	425	5	-
SZMGCG0700LAE			700	476	5	-
SZMGCG0800LAE			800	527	5	-
SZMGCG1000LAE			1000	629	5	-

AC 1804

● G 1"



● G 1"

Femmina

Femmina

CODICE	RACCORDI	DN	LUNGHEZZA mm			
SZMFBG0300LAE	Femmina G 1"	18	300	336	5	-
SZMFBG0400LAE			400	387	5	-
SZMFBG0500LAE			500	438	5	-
SZMFBG0600LAE			600	489	5	-
SZMFBG0700LAE			700	540	5	-
SZMFBG0800LAE			800	590	5	-
SZMFBG1000LAE			1000	693	5	-

AC 2502

● G 1"



● G 1"

Femmina

Femmina

CODICE	RACCORDI	DN	LUNGHEZZA mm			
TZMFBG0300LAE	Femmina G 1"	25	300	388	5	-
TZMFBG0400LAE			400	459	5	-
TZMFBG0500LAE			500	529	5	-
TZMFBG0600LAE			600	600	5	-
TZMFBG0700LAE			700	671	5	-
TZMFBG0800LAE			800	741	5	-
TZMFBG1000LAE			1000	883	5	-



DN

15
18
25



Max temperatura

110 °C



Max pressione

10 bar
10 bar
10 bar



Portata a 3 bar

83 l/min
200 l/min
280 l/min



Raggio min. di curvatura

80 mm
104 mm
132 mm



Tubo interno

EPDM



Treccia

ACCIAIO ZINCATO



Raccordi

ACCIAIO ZINCATO



Istruzioni

Pag. 444

AC 3202

● G 1" 1/4



● G 1" 1/4

Femmina

Femmina

CODICE	RACCORDI	DN	LUNGHEZZA mm			
VZMFFG0300LAE	Femmina G 1" 1/4	32	300	672	2	-
VZMFFG0400LAE			400	780	2	-
VZMFFG0500LAE			500	888	2	-
VZMFFG0600LAE			600	995	2	-
VZMFFG0700LAE			700	1.103	2	-
VZMFFG0800LAE			800	1.211	2	-
VZMFFG1000LAE			1000	1.427	2	-

AC 4002

● G 1" 1/2



● G 1" 1/2

Femmina

Femmina

CODICE	RACCORDI	DN	LUNGHEZZA mm			
XZMFGB0300LAE	Femmina G 1" 1/2	40	300	1.134	2	-
XZMFGB0400LAE			400	1.295	2	-
XZMFGB0500LAE			500	1.456	2	-
XZMFGB0600LAE			600	1.616	2	-
XZMFGB0700LAE			700	1.777	2	-
XZMFGB0800LAE			800	1.937	2	-
XZMFGB1000LAE			1000	2.259	2	-

AC 5002

● G 2"



● G 2"

Femmina

Femmina

CODICE	RACCORDI	DN	LUNGHEZZA mm			
ZZMGAB0300LAE	Femmina G 2"	50	300	1.566	1	-
ZZMGAB0400LAE			400	1.789	1	-
ZZMGAB0500LAE			500	2.012	1	-
ZZMGAB0600LAE			600	2.235	1	-
ZZMGAB0700LAE			700	2.458	1	-
ZZMGAB0800LAE			800	2.681	1	-
ZZMGAB1000LAE			1000	3.127	1	-



DN

32
40
50



Max temperatura

110 °C



Max pressione

6 bar
6 bar
6 bar



Portata a 3 bar

490 l/min
800 l/min
1300 l/min



Raggio min. di curvatura

168 mm
212 mm
275 mm



Tubo interno

EPDM



Treccia

ACCIAIO ZINCATO



Raccordi

ACCIAIO ZINCATO



Istruzioni

Pag. 444

AC 1503

● G 1/2



Maschio

Femmina Curva ● G 1/2

CODICE	RACCORDI	DN	LUNGHEZZA mm			
QZMECZ0300LAE	Maschio G 1/2 Femmina Curva G 1/2	15	300	201	5	-
QZMECZ0400LAE			400	236	5	-
QZMECZ0500LAE			500	270	5	-
QZMECZ0600LAE			600	305	5	-
QZMECZ0700LAE			700	340	5	-
QZMECZ0800LAE			800	374	5	-
QZMECZ1000LAE			1000	443	5	-

AC 1805

● G 3/4

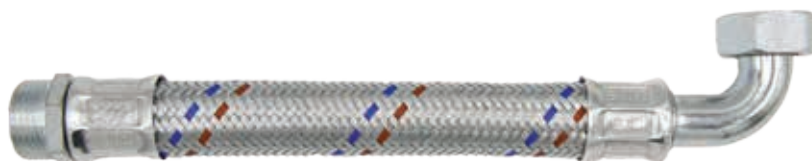

Maschio

Femmina Curva ● G 3/4

CODICE	RACCORDI	DN	LUNGHEZZA mm			
SZMEYG0300LAE	Maschio G 3/4 Femmina Curva G 3/4	18	300	280	5	-
SZMEYG0400LAE			400	330	5	-
SZMEYG0500LAE			500	382	5	-
SZMEYG0600LAE			600	432	5	-
SZMEYG0700LAE			700	483	5	-
SZMEYG0800LAE			800	535	5	-
SZMEYG1000LAE			1000	637	5	-

AC 1806

● G 1"



Maschio

Femmina Curva ● G 1"

CODICE	RACCORDI	DN	LUNGHEZZA mm			
SZMDVG0300LAE	Maschio G 1" Femmina Curva G 1"	18	300	317	2	-
SZMDVG0400LAE			400	368	2	-
SZMDVG0500LAE			500	419	2	-
SZMDVG0600LAE			600	470	2	-
SZMDVG0700LAE			700	520	2	-
SZMDVG0800LAE			800	571	2	-
SZMDVG1000LAE			1000	673	2	-



DN
15
18



Max temperatura
110 °C



Max pressione
10 bar
10 bar



Portata a 3 bar
83 l/min
200 l/min



Raggio min. di curvatura
80 mm
104 mm



Tubo interno
EPDM



Treccia
ACCIAIO ZINCATO



Raccordi
ACCIAIO ZINCATO



Istruzioni
Pag. 444

AC 2503

● G 1"

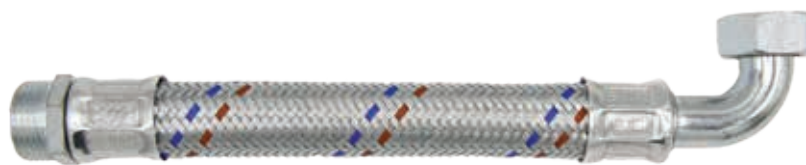

Maschio

Femmina Curva

● G 1"

CODICE	RACCORDI	DN	LUNGHEZZA mm			
TZMDVG0300LAE	Maschio G 1" Femmina Curva G 1"	25	300	394	2	-
TZMDVG0400LAE			400	465	2	-
TZMDVG0500LAE			500	535	2	-
TZMDVG0600LAE			600	606	2	-
TZMDVG0700LAE			700	677	2	-
TZMDVG0800LAE			800	748	2	-
TZMDVG1000LAE			1000	889	2	-

AC 3203

● G 1" 1/4



Maschio

Femmina Curva

● G 1" 1/4

CODICE	RACCORDI	DN	LUNGHEZZA mm			
VZMDZG0300LAE	Maschio G 1" 1/4 Femmina Curva in acciaio inox G 1" 1/4	32	300	706	2	-
VZMDZG0400LAE			400	814	2	-
VZMDZG0500LAE			500	922	2	-
VZMDZG0600LAE			600	1.030	2	-
VZMDZG0700LAE			700	1.138	2	-
VZMDZG0800LAE			800	1.246	2	-
VZMDZG1000LAE			1000	1.462	2	-



DN
25
32



Max temperatura
110 °C



Max pressione
10 bar
6 bar



Portata a 3 bar
280 l/min
490 l/min



Raggio min. di curvatura
132 mm
168 mm



Tubo interno
EPDM



Treccia
ACCIAIO ZINCATO



Raccordi
ACCIAIO ZINCATO



Istruzioni
Pag. 444



LUXOR®

TUBI FLESSIBILI INDUSTRIALI

4.2 / ACFZ-B

ACFZ-B

RACCORDI IN OTTONE



Per soddisfare le esigenze di più clienti sono nati i tubi ACFZ-B che uniscono l'economicità della treccia in acciaio

zincato alle caratteristiche migliori dei raccordi in ottone. Questi flessibili sono disponibili dal DN15 al DN50.

CARATTERISTICHE TECNICHE



DN

15
18
25
32
40
50



Max temperatura

110 °C



Max pressione

10 bar
10 bar
10 bar
6 bar
6 bar
6 bar



Portata a 3 bar

83 l/min
200 l/min
280 l/min
490 l/min
800 l/min
1300 l/min



Raggio min. di curvatura
80 mm
104 mm
132 mm
168 mm
212 mm
275 mm



Tubo interno

EPDM



Treccia

ACCIAIO
ZINCATO



Raccordi

CW617N

CAMPI DI APPLICAZIONE

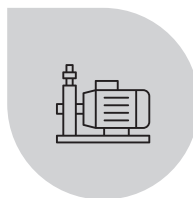

pompe



colonne montanti



impianti di riscaldamento

TUBO INTERNO

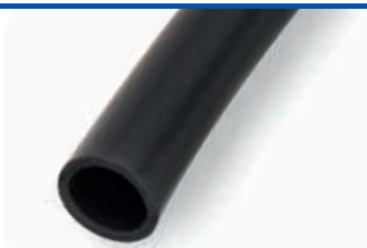

EPDM

La gomma EPDM perossidica è il materiale più utilizzato per la realizzazione del tubo interno.

Con diverse composizioni chimiche, ha proprietà igieniche e meccaniche di alto livello, unitamente ad un'assoluta resistenza all'ossidazione, agli agenti atmosferici ed alle alte temperature.

TIPOLOGIA DI RACCORDI

Maschio (raccordi ottone)

G 1/2
G 3/4
G 1"
G 1" 1/4
G 1" 1/2
G 2"



Femmina (raccordi ottone)

G 1/2
G 3/4
G 1"
G 1" 1/4
G 1" 1/2
G 2"



Femmina Curva (raccordi ottone)

G 1/2
G 3/4
G 1"
G 1" 1/4



Istruzioni
Pag. 444

Per informazioni sulle specifiche tecniche e sui prodotti certificati si prega di rivolgersi ai nostri uffici o visitare il sito web degli enti di certificazione corrispondenti.

AC 1504

● G 1/2



● G 1/2

Maschio (raccordi ottone)

Femmina (raccordi ottone)

CODICE	RACCORDI	DN	LUNGHEZZA mm			
QZMANS0300LAE	Maschio (raccordi ottone) G 1/2	15	300	181	5	-
QZMANS0400LAE			400	216	5	-
QZMANS0500LAE			500	250	5	-
QZMANS0600LAE			600	285	5	-
QZMANS0700LAE	Femmina (raccordi ottone) G 1/2	15	700	320	5	-
QZMANS0800LAE			800	354	5	-
QZMANS1000LAE			1000	423	5	-

AC 1807

● G 3/4



● G 3/4

Maschio (raccordi ottone)

Femmina (raccordi ottone)

CODICE	RACCORDI	DN	LUNGHEZZA mm			
SZMBSS0300LAE	Maschio (raccordi ottone) G 3/4	18	300	265	5	-
SZMBSS0400LAE			400	316	5	-
SZMBSS0500LAE			500	367	5	-
SZMBSS0600LAE			600	418	5	-
SZMBSS0700LAE	Femmina (raccordi ottone) G 3/4	18	700	469	5	-
SZMBSS0800LAE			800	520	5	-
SZMBSS1000LAE			1000	622	5	-

AC 2504

● G 1"



● G 1"

Maschio (raccordi ottone)

Femmina (raccordi ottone)

CODICE	RACCORDI	DN	LUNGHEZZA mm			
TZMAAS0300LAE	Maschio (raccordi ottone) G 1"	25	300	412	5	-
TZMAAS0400LAE			400	483	5	-
TZMAAS0500LAE			500	554	5	-
TZMAAS0600LAE			600	624	5	-
TZMAAS0700LAE	Femmina (raccordi ottone) G 1"	25	700	695	5	-
TZMAAS0800LAE			800	766	5	-
TZMAAS1000LAE			1000	907	5	-



DN
15
18
25



Max temperatura
110 °C



Max pressione
10 bar
10 bar
10 bar



Portata a 3 bar
83 l/min
200 l/min
280 l/min



Raggio min. di curvatura
80 mm
104 mm
132 mm



Tubo interno
EPDM



Treccia
ACCIAIO ZINCATO



Raccordi
CW617N



Istruzioni
Pag. 444

AC 3204

● G 1" 1/4

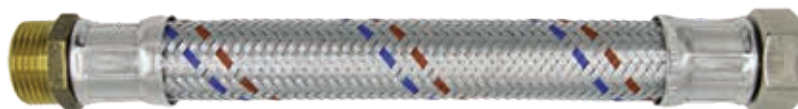

● G 1" 1/4

Maschio (raccordi ottone)

Femmina (raccordi ottone)

CODICE	RACCORDI	DN	LUNGHEZZA mm			
VZMAFS0300LAE	Maschio (raccordi ottone) G 1" 1/4	32	300	714	2	-
VZMAFS0400LAE			400	822	2	-
VZMAFS0500LAE			500	930	2	-
VZMAFS0600LAE			600	1.038	2	-
VZMAFS0700LAE	Femmina (raccordi ottone) G 1" 1/4	32	700	1.146	2	-
VZMAFS0800LAE			800	1.254	2	-
VZMAFS1000LAE			1000	1.470	2	-

AC 4003

● G 1" 1/2



● G 1" 1/2

Maschio (raccordi ottone)

Femmina (raccordi ottone)

CODICE	RACCORDI	DN	LUNGHEZZA mm			
XZMAES0300LAE	Maschio (raccordi ottone) G 1" 1/2	40	300	1.140	2	-
XZMAES0400LAE			400	1.300	2	-
XZMAES0500LAE			500	1.461	2	-
XZMAES0600LAE			600	1.622	2	-
XZMAES0700LAE	Femmina (raccordi ottone) G 1" 1/2	40	700	1.783	2	-
XZMAES0800LAE			800	1.943	2	-
XZMAES1000LAE			1000	2.264	2	-

AC 5003

● G 2"

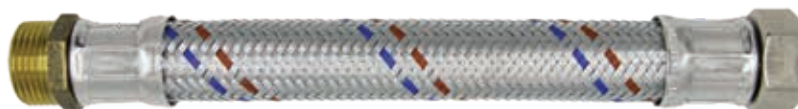

● G 2"

Maschio (raccordi ottone)

Femmina (raccordi ottone)

CODICE	RACCORDI	DN	LUNGHEZZA mm			
ZZMBNS0300LAE	Maschio (raccordi ottone) G 2"	50	300	1.641	1	-
ZZMBNS0400LAE			400	1.864	1	-
ZZMBNS0500LAE			500	2.087	1	-
ZZMBNS0600LAE			600	2.310	1	-
ZZMBNS0700LAE	Femmina (raccordi ottone) G 2"	50	700	2.533	1	-
ZZMBNS0800LAE			800	2.756	1	-
ZZMBNS1000LAE			1000	3.202	1	-



DN
32
40
50



Max temperatura
110 °C



Max pressione
6 bar
6 bar
6 bar



Portata a 3 bar
490 l/min
800 l/min
1300 l/min



Raggio min. di curvatura
168 mm
212 mm
275 mm



Tubo interno
EPDM



Treccia
ACCIAIO ZINCATO



Raccordi
CW617N



Istruzioni
Pag. 444

AC 1505

● G 1/2



● G 1/2

Femmina (raccordi ottone)

Femmina (raccordi ottone)

CODICE	RACCORDI	DN	LUNGHEZZA mm			
QZMFHS0300LAE	Femmina (raccordi ottone) G 1/2	15	300	185	5	-
QZMFHS0400LAE			400	220	5	-
QZMFHS0500LAE			500	255	5	-
QZMFHS0600LAE			600	289	5	-
QZMFHS0700LAE	Femmina (raccordi ottone) G 1/2	15	700	323	5	-
QZMFHS0800LAE			800	358	5	-
QZMFHS1000LAE			1000	427	5	-

AC 1808

● G 3/4



● G 3/4

Femmina (raccordi ottone)

Femmina (raccordi ottone)

CODICE	RACCORDI	DN	LUNGHEZZA mm			
SZMGBS0300LAE	Femmina (raccordi ottone) G 3/4	18	300	270	5	-
SZMGBS0400LAE			400	321	5	-
SZMGBS0500LAE			500	372	5	-
SZMGBS0600LAE			600	423	5	-
SZMGBS0700LAE	Femmina (raccordi ottone) G 3/4	18	700	474	5	-
SZMGBS0800LAE			800	525	5	-
SZMGBS1000LAE			1000	627	5	-

AC 2505

● G 1"



● G 1"

Femmina (raccordi ottone)

Femmina (raccordi ottone)

CODICE	RACCORDI	DN	LUNGHEZZA mm			
TZMFAS0300LAE	Femmina (raccordi ottone) G 1"	25	300	508	5	-
TZMFAS0400LAE			400	578	5	-
TZMFAS0500LAE			500	649	5	-
TZMFAS0600LAE			600	720	5	-
TZMFAS0700LAE	Femmina (raccordi ottone) G 1"	25	700	790	5	-
TZMFAS0800LAE			800	861	5	-
TZMFAS1000LAE			1000	1.002	5	-



DN
15
18
25



Max temperatura
110 °C



Max pressione
10 bar
10 bar
10 bar



Portata a 3 bar
83 l/min
200 l/min
280 l/min



Raggio min. di curvatura
80 mm
104 mm
132 mm



Tubo interno
EPDM



Treccia
ACCIAIO ZINCATO



Raccordi
CW617N



Istruzioni
Pag. 444

AC 3205

● G 1" 1/4



● G 1" 1/4

Femmina (raccordi ottone)

Femmina (raccordi ottone)

CODICE	RACCORDI	DN	LUNGHEZZA mm			
VZMFES0300LAE	Femmina (raccordi ottone) G 1" 1/4	32	300	704	2	-
VZMFES0400LAE			400	812	2	-
VZMFES0500LAE			500	920	2	-
VZMFES0600LAE			600	1.028	2	-
VZMFES0700LAE			700	1.136	2	-
VZMFES0800LAE			800	1.244	2	-
VZMFES1000LAE			1000	1.460	2	-

AC 4004

● G 1" 1/2



● G 1" 1/2

Femmina (raccordi ottone)

Femmina (raccordi ottone)

CODICE	RACCORDI	DN	LUNGHEZZA mm			
XZMFGS0300LAE	Femmina (raccordi ottone) G 1" 1/2	40	300	1.180	2	-
XZMFGS0400LAE			400	1.341	2	-
XZMFGS0500LAE			500	1.501	2	-
XZMFGS0600LAE			600	1.662	2	-
XZMFGS0700LAE			700	1.823	2	-
XZMFGS0800LAE			800	1.983	2	-
XZMFGS1000LAE			1000	2.305	2	-

AC 5004

● G 2"



● G 2"

Femmina (raccordi ottone)

Femmina (raccordi ottone)

CODICE	RACCORDI	DN	LUNGHEZZA mm			
ZZMGAS0300LAE	Femmina (raccordi ottone) G 2"	50	300	1.672	1	-
ZZMGAS0400LAE			400	1.895	1	-
ZZMGAS0500LAE			500	2.118	1	-
ZZMGAS0600LAE			600	2.341	1	-
ZZMGAS0700LAE			700	2.564	1	-
ZZMGAS0800LAE			800	2.787	1	-
ZZMGAS1000LAE			1000	3.233	1	-



DN
32
40
50



Max temperatura
110 °C



Max pressione
6 bar
6 bar
6 bar



Portata a 3 bar
490 l/min
800 l/min
1300 l/min



Raggio min. di curvatura
168 mm
212 mm
275 mm



Tubo interno
EPDM



Treccia
ACCIAIO ZINCATO



Raccordi
CW617N



Istruzioni
Pag. 444

AC 1506

● G 1/2



● G 1/2

Maschio (raccordi ottone)

Femmina Curva (raccordi ottone)

CODICE	RACCORDI	DN	LUNGHEZZA mm			
QZMECS0300LAE	Maschio (raccordi ottone) G 1/2	15	300	195	5	-
QZMECS0400LAE			400	230	5	-
QZMECS0500LAE			500	265	5	-
QZMECS0600LAE			600	299	5	-
QZMECS0700LAE	Femmina Curva (raccordi ottone) G 1/2	15	700	333	5	-
QZMECS0800LAE			800	368	5	-
QZMECS1000LAE			1000	437	5	-

AC 1809

● G 3/4

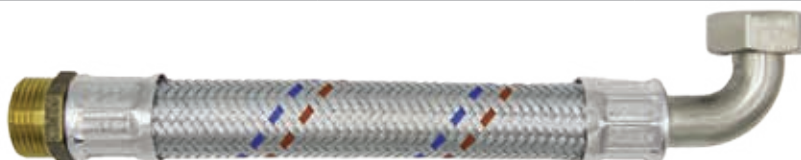

● G 3/4

Maschio (raccordi ottone)

Femmina Curva (raccordi ottone)

CODICE	RACCORDI	DN	LUNGHEZZA mm			
SZMENS0300LAE	Maschio (raccordi ottone) G 3/4	18	300	272	5	-
SZMENS0400LAE			400	323	5	-
SZMENS0500LAE			500	374	5	-
SZMENS0600LAE			600	425	5	-
SZMENS0700LAE	Femmina Curva (raccordi ottone) G 3/4	18	700	476	5	-
SZMENS0800LAE			800	527	5	-
SZMENS1000LAE			1000	627	5	-

AC 2506

● G 1"

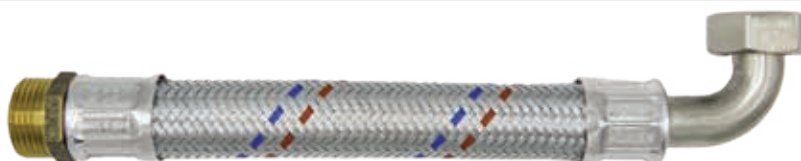

● G 1"

Maschio (raccordi ottone)

Femmina Curva (raccordi ottone)

CODICE	RACCORDI	DN	LUNGHEZZA mm			
TZMDUS0300LAE	Maschio (raccordi ottone) G 1"	25	300	413	2	-
TZMDUS0400LAE			400	483	2	-
TZMDUS0500LAE			500	554	2	-
TZMDUS0600LAE			600	625	2	-
TZMDUS0700LAE	Femmina Curva (raccordi ottone) G 1"	25	700	695	2	-
TZMDUS0800LAE			800	766	2	-
TZMDUS1000LAE			1000	906	2	-

AC 3206

● G 1" 1/4



● G 1" 1/4

Maschio (raccordi ottone)

Femmina Curva

CODICE	RACCORDI	DN	LUNGHEZZA mm			
VZMDYS0300LAE	Maschio (raccordi ottone) G 1" 1/4	32	300	715	2	-
VZMDYS0400LAE			400	823	2	-
VZMDYS0500LAE			500	931	2	-
VZMDYS0600LAE			600	1.039	2	-
VZMDYS0700LAE	Femmina Curva in acciaio inox G 1" 1/4	32	700	1.147	2	-
VZMDYS0800LAE			800	1.255	2	-
VZMDYS1000LAE			1000	1.470	2	-



DN

15
18
25
32



Max temperatura

110 °C



Max pressione

10 bar
10 bar
10 bar
6 bar



Portata a 3 bar

83 l/min
200 l/min
280 l/min
490 l/min



Raggio min. di curvatura

80 mm
104 mm
132 mm
168 mm



Tubo interno

EPDM



Treccia

ACCIAIO ZINCATO



Raccordi

CW617N



Istruzioni

Pag. 444



LUXOR®

TUBI FLESSIBILI INDUSTRIALI

4.3 / ACFX

ACFX

FLESSIBILI IN ACCIAIO INOX



Rivestiti di treccia metallica INOX con raccordi in OTTONE, sono adatti al collegamento di pompe, caldaie, autoclavi

e colonne montanti, l'ideale per le applicazioni industriali. Sono disponibili dal diametro DN15 al DN50.

CARATTERISTICHE TECNICHE



DN

15
18
25
32
40
50



Max temperatura

110 °C



Max pressione

10 bar
10 bar
10 bar
6 bar
6 bar
6 bar



Portata a 3 bar

83 l/min
200 l/min
280 l/min
490 l/min
800 l/min
1300 l/min



Raggio min. di curvatura
80 mm
104 mm
132 mm
168 mm
212 mm
275 mm



Tubo interno

EPDM



Treccia

INOX AISI 304



Raccordi

CW617N

CAMPI DI APPLICAZIONE

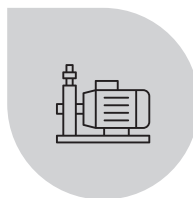

pompe



colonne montanti



impianti di riscaldamento

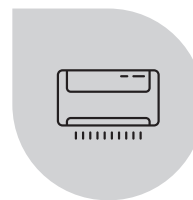

impianti condizionamento

TUBO INTERNO

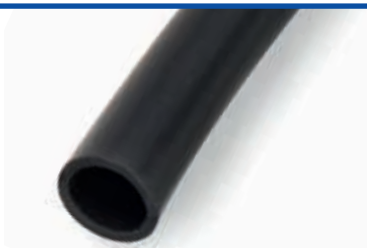

EPDM

La gomma EPDM perossidica è il materiale più utilizzato per la realizzazione del tubo interno.

Con diverse composizioni chimiche, ha proprietà igieniche e meccaniche di alto livello, unitamente ad un'assoluta resistenza all'ossidazione, agli agenti atmosferici ed alle alte temperature.

TIPOLOGIA DI RACCORDI

Maschio

G 1/2
G 3/4
G 1"
G 1" 1/4
G 1" 1/2
G 2"



Femmina

G 1/2
G 3/4
G 1"
G 1" 1/4
G 1" 1/2
G 2"



Femmina Curva

G 1/2
G 3/4
G 1"
G 1" 1/4



CERTIFICAZIONI

EN 13618

UE



DN 15-18-25



TÜV

Germania



Istruzioni
Pag. 444

Per informazioni sulle specifiche tecniche e sui prodotti certificati si prega di rivolgersi ai nostri uffici o visitare il sito web degli enti di certificazione corrispondenti.

AC 1507

● G 1/2



● G 1/2

Maschio (raccordi ottone)

Femmina (raccordi ottone)

CODICE	RACCORDI	DN	LUNGHEZZA mm			
QCMANS0300TAE	Maschio (raccordi ottone) G 1/2	15	300	167	5	-
QCMANS0400TAE			400	196	5	-
QCMANS0500TAE			500	225	5	-
QCMANS0600TAE			600	254	5	-
QCMANS0700TAE	Femmina (raccordi ottone) G 1/2	15	700	283	5	-
QCMANS0800TAE			800	612	5	-
QCMANS1000TAE			1000	871	5	-

AC 1810

● G 3/4



● G 3/4

Maschio (raccordi ottone)

Femmina (raccordi ottone)

CODICE	RACCORDI	DN	LUNGHEZZA mm			
SCMBSS0300TAE	Maschio (raccordi ottone) G 3/4	18	300	247	5	-
SCMBSS0400TAE			400	291	5	-
SCMBSS0500TAE			500	335	5	-
SCMBSS0600TAE			600	379	5	-
SCMBSS0700TAE	Femmina (raccordi ottone) G 3/4	18	700	423	5	-
SCMBSS0800TAE			800	467	5	-
SCMBSS1000TAE			1000	555	5	-

AC 2507

● G 1"



● G 1"

Maschio (raccordi ottone)

Femmina (raccordi ottone)

CODICE	RACCORDI	DN	LUNGHEZZA mm			
TCMAAS0300TAE	Maschio (raccordi ottone) G 1"	25	300	398	5	-
TCMAAS0400TAE			400	464	5	-
TCMAAS0500TAE			500	529	5	-
TCMAAS0600TAE			600	594	5	-
TCMAAS0700TAE	Femmina (raccordi ottone) G 1"	25	700	660	5	-
TCMAAS0800TAE			800	725	5	-
TCMAAS1000TAE			1000	856	5	-



DN
15
18
25



Max temperatura
110 °C



Max pressione
10 bar
10 bar
10 bar



Portata a 3 bar
83 l/min
200 l/min
280 l/min



Raggio min. di curvatura
80 mm
104 mm
132 mm



Tubo interno
EPDM



Treccia
INOX AISI 304



Raccordi
CW617N



Istruzioni
Pag. 444

AC 3207

● G 1" 1/4



● G 1" 1/4

Maschio (raccordi ottone)

Femmina (raccordi ottone)

CODICE	RACCORDI	DN	LUNGHEZZA mm				
VCMAFS0300TAE	Maschio (raccordi ottone) G 1" 1/4	32	300	684	2	-	
VCMAFS0400TAE			400	780	2	-	
VCMAFS0500TAE			500	876	2	-	
VCMAFS0600TAE			600	972	2	-	
VCMAFS0700TAE			Femmina (raccordi ottone) G 1" 1/4	700	1.068	2	-
VCMAFS0800TAE				800	1.164	2	-
VCMAFS1000TAE				1000	1.356	2	-

AC 4005

● G 1" 1/2



● G 1" 1/2

Maschio (raccordi ottone)

Femmina (raccordi ottone)

CODICE	RACCORDI	DN	LUNGHEZZA mm				
XCMAES0300TAE	Maschio (raccordi ottone) G 1" 1/2	40	300	1.136	2	-	
XCMAES0400TAE			400	1.296	2	-	
XCMAES0500TAE			500	1.456	2	-	
XCMAES0600TAE			600	1.616	2	-	
XCMAES0700TAE			Femmina (raccordi ottone) G 1" 1/2	700	1.776	2	-
XCMAES0800TAE				800	1.936	2	-
XCMAES1000TAE				1000	2.256	2	-

AC 5005

● G 2"



● G 2"

Maschio (raccordi ottone)

Femmina (raccordi ottone)

CODICE	RACCORDI	DN	LUNGHEZZA mm				
ZCMBNS0300TAE	Maschio (raccordi ottone) G 2"	50	300	1.618	1	-	
ZCMBNS0400TAE			400	1.840	1	-	
ZCMBNS0500TAE			500	2.063	1	-	
ZCMBNS0600TAE			600	2.285	1	-	
ZCMBNS0700TAE			Femmina (raccordi ottone) G 2"	700	2.507	1	-
ZCMBNS0800TAE				800	2.729	1	-
ZCMBNS1000TAE				1000	3.174	1	-



DN
32
40
50



Max temperatura
110 °C



Max pressione
6 bar
6 bar
6 bar



Portata a 3 bar
490 l/min
800 l/min
1300 l/min



Raggio min. di curvatura
168 mm
212 mm
275 mm



Tubo interno
EPDM



Treccia
INOX AISI 304



Raccordi
CW617N



Istruzioni
Pag. 444

AC 1508

● G 1/2



● G 1/2

Femmina (raccordi ottone)

Femmina (raccordi ottone)

CODICE	RACCORDI	DN	LUNGHEZZA mm			
QCMFHS0300TAE	Femmina (raccordi ottone) G 1/2	15	300	171	5	-
QCMFHS0400TAE			400	200	5	-
QCMFHS0500TAE			500	229	5	-
QCMFHS0600TAE			600	258	5	-
QCMFHS0700TAE	Femmina (raccordi ottone) G 1/2	15	700	287	5	-
QCMFHS0800TAE			800	316	5	-
QCMFHS1000TAE			1000	374	5	-

AC 1811

● G 3/4



● G 3/4

Femmina (raccordi ottone)

Femmina (raccordi ottone)

CODICE	RACCORDI	DN	LUNGHEZZA mm			
SCMGBS0300TAE	Femmina (raccordi ottone) G 3/4	18	300	251	5	-
SCMGBS0400TAE			400	295	5	-
SCMGBS0500TAE			500	339	5	-
SCMGBS0600TAE			600	383	5	-
SCMGBS0700TAE	Femmina (raccordi ottone) G 3/4	18	700	427	5	-
SCMGBS0800TAE			800	471	5	-
SCMGBS1000TAE			1000	559	5	-

AC 2508

● G 1"



● G 1"

Femmina (raccordi ottone)

Femmina (raccordi ottone)

CODICE	RACCORDI	DN	LUNGHEZZA mm			
TCMFAS0300TAE	Femmina (raccordi ottone) G 1"	25	300	403	5	-
TCMFAS0400TAE			400	469	5	-
TCMFAS0500TAE			500	534	5	-
TCMFAS0600TAE			600	599	5	-
TCMFAS0700TAE	Femmina (raccordi ottone) G 1"	25	700	665	5	-
TCMFAS0800TAE			800	730	5	-
TCMFAS1000TAE			1000	861	5	-



DN
15
18
25



Max temperatura
110 °C



Max pressione
10 bar
10 bar
10 bar



Portata a 3 bar
83 l/min
200 l/min
280 l/min



Raggio min. di curvatura
80 mm
104 mm
132 mm



Tubo interno
EPDM



Treccia
INOX AISI 304



Raccordi
CW617N



Istruzioni
Pag. 444

AC 3208

● G 1" 1/4



● G 1" 1/4

Femmina (raccordi ottone)

Femmina (raccordi ottone)

CODICE	RACCORDI	DN	LUNGHEZZA mm			
VCMFES0300TAE	Femmina (raccordi ottone) G 1" 1/4	32	300	673	2	-
VCMFES0400TAE			400	769	2	-
VCMFES0500TAE			500	865	2	-
VCMFES0600TAE			600	961	2	-
VCMFES0700TAE	Femmina (raccordi ottone) G 1" 1/4	32	700	1.057	2	-
VCMFES0800TAE			800	1.154	2	-
VCMFES1000TAE			1000	1.346	2	-

AC 4006

● G 1" 1/2



● G 1" 1/2

Femmina (raccordi ottone)

Femmina (raccordi ottone)

CODICE	RACCORDI	DN	LUNGHEZZA mm			
XCMFGS0300TAE	Femmina (raccordi ottone) G 1" 1/2	40	300	1.176	2	-
XCMFGS0400TAE			400	1.336	2	-
XCMFGS0500TAE			500	1.496	2	-
XCMFGS0600TAE			600	1.656	2	-
XCMFGS0700TAE	Femmina (raccordi ottone) G 1" 1/2	40	700	1.816	2	-
XCMFGS0800TAE			800	1.976	2	-
XCMFGS1000TAE			1000	2.296	2	-

AC 5006

● G 2"



● G 2"

Femmina (raccordi ottone)

Femmina (raccordi ottone)

CODICE	RACCORDI	DN	LUNGHEZZA mm			
ZCMGAS0300TAE	Femmina (raccordi ottone) G 2"	50	300	1.628	1	-
ZCMGAS0400TAE			400	1.850	1	-
ZCMGAS0500TAE			500	2.073	1	-
ZCMGAS0600TAE			600	2.295	1	-
ZCMGAS0700TAE	Femmina (raccordi ottone) G 2"	50	700	2.517	1	-
ZCMGAS0800TAE			800	2.739	1	-
ZCMGAS1000TAE			1000	3.184	1	-



DN
32
40
50



Max temperatura
110 °C



Max pressione
6 bar
6 bar
6 bar



Portata a 3 bar
490 l/min
800 l/min
1300 l/min



Raggio min. di curvatura
168 mm
212 mm
275 mm



Tubo interno
EPDM



Treccia
INOX AISI 304



Raccordi
CW617N



Istruzioni
Pag. 444

AC 1509

● G 1/2



● G 1/2

Maschio (raccordi ottone)

Femmina Curva (raccordi ottone)

CODICE	RACCORDI	DN	LUNGHEZZA mm			
QCMECS0300TAE	Maschio (raccordi ottone) G 1/2	15	300	183	5	-
QCMECS0400TAE			400	212	5	-
QCMECS0500TAE			500	241	5	-
QCMECS0600TAE	Femmina Curva (raccordi ottone) G 1/2	15	600	270	5	-
QCMECS0700TAE			700	299	5	-
QCMECS0800TAE			800	328	5	-
QCMECS1000TAE			1000	386	5	-

AC 1812

● G 3/4

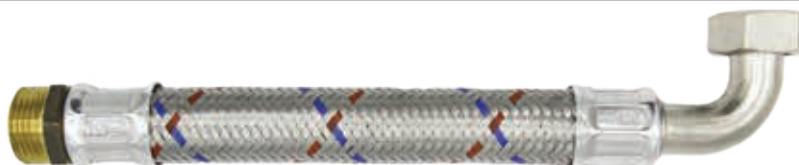

● G 3/4

Maschio (raccordi ottone)

Femmina Curva (raccordi ottone)

CODICE	RACCORDI	DN	LUNGHEZZA mm			
SCMENS0300TAE	Maschio (raccordi ottone) G 3/4	18	300	256	5	-
SCMENS0400TAE			400	300	5	-
SCMENS0500TAE			500	344	5	-
SCMENS0600TAE	Femmina Curva (raccordi ottone) G 3/4	18	600	388	5	-
SCMENS0700TAE			700	432	5	-
SCMENS0800TAE			800	476	5	-
SCMENS1000TAE			1000	564	5	-

AC 2509

● G 1"



● G 1"

Maschio (raccordi ottone)

Femmina Curva (raccordi ottone)

CODICE	RACCORDI	DN	LUNGHEZZA mm			
TCMDUS0300TAE	Maschio (raccordi ottone) G 1"	25	300	400	2	-
TCMDUS0400TAE			400	466	2	-
TCMDUS0500TAE			500	531	2	-
TCMDUS0600TAE	Femmina Curva (raccordi ottone) G 1"	25	600	596	2	-
TCMDUS0700TAE			700	662	2	-
TCMDUS0800TAE			800	727	2	-
TCMDUS1000TAE			1000	858	2	-

AC 3209

● G 1" 1/4



● G 1" 1/4

Maschio (raccordi ottone)

Femmina Curva

CODICE	RACCORDI	DN	LUNGHEZZA mm			
VCMDYS0300TAE	Maschio (raccordi ottone) G 1" 1/4	32	300	689	2	-
VCMDYS0400TAE			400	785	2	-
VCMDYS0500TAE			500	881	2	-
VCMDYS0600TAE	Femmina Curva in acciaio inox G 1" 1/4	32	600	977	2	-
VCMDYS0700TAE			700	1.073	2	-
VCMDYS0800TAE			800	1.169	2	-
VCMDYS1000TAE			1000	1.361	2	-



DN

15
18
25
32



Max temperatura

110 °C



Max pressione

10 bar
10 bar
10 bar
6 bar



Portata a 3 bar

83 l/min
200 l/min
280 l/min
490 l/min



Raggio min. di curvatura

80 mm
104 mm
132 mm
168 mm



Tubo interno

EPDM



Treccia

INOX AISI 304



Raccordi

CW617N



Istruzioni

Pag. 444



LUXOR®

TUBI FLESSIBILI INDUSTRIALI

4.4 / ACEX

ACEX

FLESSIBILI ESTENSIBILI



Per il collegamento tra la rete idrica e le caldaie murali. Flessibile metallico estensibile con soffiutto in acciaio inox di-

ponibile in diverse misure per soddisfare le esigenze dell'installatore e dei produttori di caldaie murali.

CARATTERISTICHE TECNICHE



DN

15
20
25



Max temperatura

90 °C



Max pressione

6
4
4



Portata a 3 bar

-



Raggio min. di curvatura

-



Tubo interno

AISI 316



Treccia

-



Raccordi

AISI 303
CW614N

CAMPI DI APPLICAZIONE

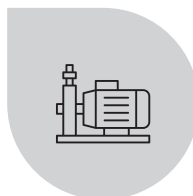

pompe



colonne montanti



impianti di riscaldamento

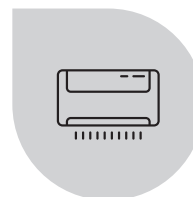

impianti condizionamento

TIPOLOGIA DI RACCORDI

Maschio

R 1/2
R 3/4
R 1"



Femmina

G 1/2
G 3/4
G 1"



Istruzioni
Pag. 444

Per informazioni sulle specifiche tecniche e sui prodotti certificati si prega di rivolgersi ai nostri uffici o visitare il sito web degli enti di certificazione corrispondenti.

AC 1510

● G 1/2



● G 1/2

Maschio

Femmina

CODICE	RACCORDI	DN	LUNGHEZZA mm			
81200100	Maschio R 1/2	15	90 x 140	78	-	10
81200200			130 x 220	86	-	10
81200300	Femmina G 1/2		220 x 420	112	-	10

AC 1511

● G 1/2



● G 3/4

Maschio

Femmina

CODICE	RACCORDI	DN	LUNGHEZZA mm			
81210100	Maschio R 1/2	15	90 x 140	100	-	10
81210200			130 x 220	112	-	10
81210300	Femmina G 3/4		220 x 420	152	-	10

AC 2001

● G 3/4



● G 3/4

Maschio

Femmina

CODICE	RACCORDI	DN	LUNGHEZZA mm			
81220100	Maschio R 3/4	20	90 x 140	102	-	10
81220200			130 x 220	118	-	10
81220300	Femmina G 3/4		220 x 420	164	-	10

AC 2510

● G 1"



● G 1"

Maschio

Femmina

CODICE	RACCORDI	DN	LUNGHEZZA mm			
81230100	Maschio R 1"	25	90 x 140	196	-	10
81230200			130 x 220	222	-	10
81230300	Femmina G 1"		220 x 420	296	-	10



DN
15
20
25



Max temperatura
90 °C



Max pressione
6
4
4



Portata a 3 bar
-



Raggio min. di curvatura
-



Tubo interno
AISI 316



Treccia
-



Raccordi
AISI 303
CW614N



Istruzioni
Pag. 444

ISTRUZIONI DI INSTALLAZIONE

I tubi flessibili Luxor Spa sono progettati per l'adduzione e la distribuzione di acqua. Il trasporto di altri liquidi o soluzioni non viene garantito se non espressamente concordato con l'Ufficio Tecnico.

Eseguire sempre il collaudo dell'impianto dopo l'installazione dei tubi flessibili per verificare perdite o difettosità funzionali del prodotto.

Verificare la corretta messa a terra delle apparecchiature elettriche (impianti di condizionamento, vasche idromassaggio, ecc.) a cui vengono collegati i tubi flessibili.

Eventuali correnti disperse potrebbero favorire il fenomeno della corrosione. Per impianti situati in condizioni di umidità molto elevata e in cui si genera condensa è necessario utilizzare tubi flessibili con treccia e bussole inox.

Progettare l'impianto utilizzando flessibili di lunghezza adeguata e raccordi atti a ridurre al minimo torsioni e tensioni del tubo (verificare sempre le schede del prodotto).

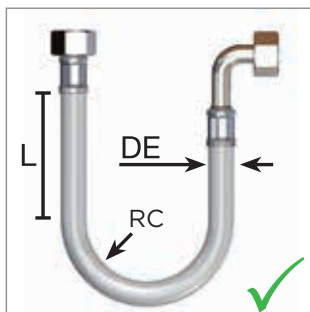

$RC \geq 4 DE$ $L \geq 4 DE$



Verificare sempre che le bussole di serraggio siano pressate e che non fuoriescano fili di trecciatura. In caso di dubbio non installare il tubo flessibile.



I flessibili devono mantenere un tratto rettilineo in corrispondenza dei raccordi pari a 4 volte il diametro esterno del tubo (DN6 = Ø 10mm → tratto rettilineo 40 mm), il raggio di curvatura non deve essere inferiore a 4 volte il diametro esterno del tubo (DN6 = Ø 10mm → raggio di curvatura 40 mm).

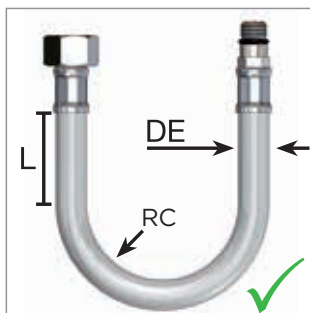

$RC \geq 4 DE$ $L \geq 4 DE$



Non installare il tubo flessibile in condizioni di torsione o tensione.

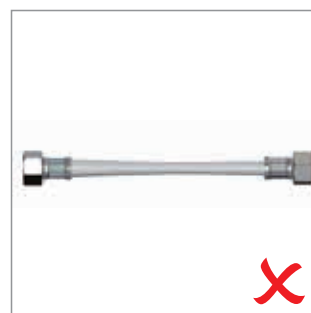

I flessibili devono poter essere ispezionati. Non installare all'interno di muri o in cunicoli non ispezionabili. Non rivestire con materiale isolante (tranne in caso di flessibili con treccia inox e bussole inox).

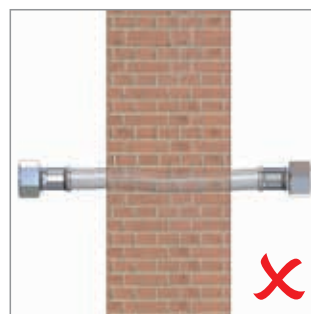

Utilizzare solo attrezzi adeguati alla tipologia di prodotto. Gli attrezzi vanno utilizzati solo in presenza di dado esagonale, ogni altra configurazione (raccordo cilindrico, ghiera zigrinata, ...) deve esser chiusa a mano (forza di chiusura non superiore a 3 Nm).



Non utilizzare alcun attrezzo sulla bussola di serraggio. Una forza applicata a questa bussola ne determina spesso il danneggiamento e la conseguente rottura del tubo flessibile.



Non assemblare mai due o più flessibili in serie, in caso scegliere una lunghezza maggiore.

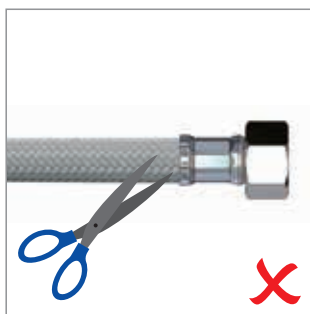

Evitare di colpire il tubo con oggetti taglienti o appuntiti per non danneggiare la treccia esterna.

RACCORDI NORMALI

Per il corretto montaggio attenersi alle seguenti istruzioni:

- verificare che la filettatura del raccordo (A) del tubo flessibile corrisponda a quella del corpo del rubinetto (B);
- verificare la presenza della guarnizione sul raccordo femmina (C);
- non applicare canapa e/o teflon sul filetto (A) del raccordo.

Attenzione! Serraggio da 2 a 3 Nm.

I maschi con sede o-ring sono appositamente progettati per garantire la tenuta tra il raccordo ed il corpo del rubinetto. Non è necessario serrare con la chiave; la forza della mano è sufficiente.

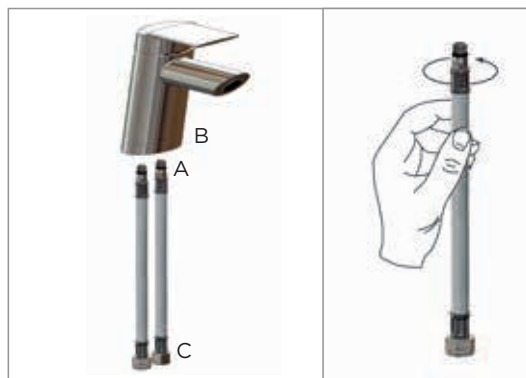

RACCORDI A COMPRESSIONE

Per il corretto montaggio attenersi alle seguenti istruzioni:

- verificare che la cartuccia (2) sia montata esattamente come sullo schema poiché se capovolta crea problemi di tenuta.
- I raccordi a stringere o compressione devono essere collegati a tubetti con uno spessore di parete non inferiore a 0,75 mm. I raccordi a compressione RCG, RCC e RCB devono essere avvitati con una coppia di serraggio compresa tra 25 e 30 Nm.

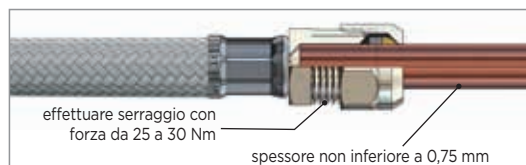

ISTRUZIONI DI MANUTENZIONE

- Monitorare periodicamente lo stato dei tubi flessibili, in caso di ossidazione o evidente stato di usura provvedere alla sostituzione.
- Evitare l'esposizione diretta o indiretta a sostanze corrosive, comprese sostanze utilizzate per le pulizie (candeggina e similari).
- Per la pulizia utilizzare solo panni umidi (non bagnati) senza l'ausilio di sostanze per la pulizia.
- Evitare di colpire il tubo con oggetti taglienti o appuntiti per evitare la rottura della treccia esterna (comprese cassette e contenitori metallici, in legno o altri materiali).
- In caso di impianti in luoghi periodicamente disabitati (per esempio case vacanze oppure in luoghi con condizioni climatiche particolarmente rigide) verificare sempre la chiusura dell'impianto e, in ogni caso, evitare di lasciare l'impianto in pressione.

ISTRUZIONI DI LUNGHEZZA

Tutti i tubi flessibili devono essere fabbricati in lunghezze L misurate come mostrato in figura da un minimo di 90 mm ad un massimo di 2000 mm, in conformità alla norma EN 13618.

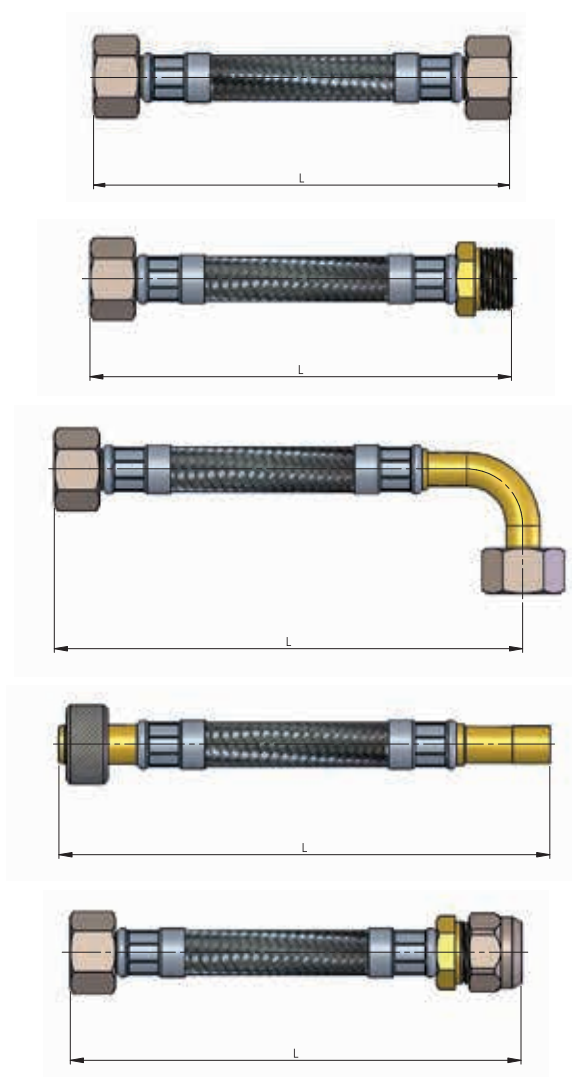

La lunghezza effettiva rispetto alla lunghezza L dichiarata dal fornitore deve essere compresa tra le seguenti tolleranze ammesse, in conformità alla norma EN 13618:

- $L \leq 400$ mm: +10 mm / 0
- $400 \text{ mm} < L \leq 1000$ mm: +20 mm / 0
- $1000 \text{ mm} < L \leq 2000$ mm: +30 mm / 0



LUXOR®

5 / COLLEGAMENTI RIGIDI SOTTOLAVABO

COLLEGAMENTI RIGIDI SOTTOLAVABO



CARATTERISTICHE TECNICHE



Max temperatura

90 °C



Max pressione

10 bar

CARATTERISTICHE COSTRUTTIVE

I collegamenti rigidi sottolavabo offrono tutta la qualità e la garanzia del prodotto Made in Italy. La gamma dei prodotti include svariati tubetti in rame cromato, curvette direzionabili attraverso raccordi snodabili e squadrette sfilabili a lunghezza variabile, tutte soluzioni tecniche che fanno dei collegamenti rigidi sottolavabo Luxor la soluzione ideale per ogni tipo di installazione.

GAMMA

Tutta la gamma viene prodotta con finitura cromata a telaio che garantisce maggiori spessori di ricopertura e di conseguenza una maggiore resistenza all'invecchiamento e alla corrosione, nonché una finitura estetica di livello superiore. Tale cromatura viene realizzata utilizzando sostanze e processi galvanici conformi alle più rigide normative internazionali in

materia di sanità e di sicurezza ambientale.

TUBETTI

I tubetti di collegamento vengono realizzati utilizzando rame disossidato al fosforo qualità Cu-DHP con composizione chimica Cu 99,9% min, le cui caratteristiche meccaniche, le dimensioni e le tolleranze sono rispondenti alla norma EN1057 e norme ad essa collegate. Per offrire una migliore qualità di prodotto i tubetti vengono lucidati al momento del taglio e viene eseguita una "doppia cartellatura" che garantisce una maggiore resistenza in fase di assemblaggio e assicura l'eliminazione di bave e spigoli vivi causa di possibili perdite. Tutti i particolari realizzati vengono rigorosamente lavati in vasche ad ultrasuoni con agenti neutri che permettono di eliminare sostanze di lavorazione residue.

SQUADRETTE E RACCORDI

Le squadrette e i raccordi in ottone CW617N e CW614N sono a basso contenuto di piombo in conformità alle più recenti normative UNI EN12165 e UNI EN12164.

ROSETTE

Le rosette sono realizzate in acciaio inox AISI 430 resistente all'azione degli agenti atmosferici, alle soluzioni alcaline degli acidi organici e all'ossidazione fino ad alte temperature.

Le tenute sono garantite dall'utilizzo di guarnizioni piane in EPDM perossidico e da cartucce di serraggio idonee per l'aduzione di acqua potabile.



CARTUCCIA RCC



La cartuccia RCC è la soluzione più sicura e funzionale per la connessione dei collegamenti rigidi sottolavabo alle utenze finali. Essendo i tre componenti raccolti in un corpo unico, la cartuccia RCC è la soluzione definitiva ai problemi di installazione dei raccordi a compressione.

Non più componenti persi o montati in modo erraneo, ma un solo pezzo che garantisce un'ottima tenuta meccanica e idraulica allo stesso tempo.

1. Rondella a stringere in ottone CW614N

La rondella in ottone possiede ottime caratteristiche meccaniche grazie al processo di ricottura che migliora la malleabilità del materiale garantendo il corretto accoppiamento tra raccordo e tubo senza esercitare un'eccessiva forza di serraggio.

2. Guarnizione interna in NBR

Campo di utilizzo per temperature fino a 90°C: le guarnizioni in NBR possiedono buone proprietà meccaniche, bassa deformazione permanente e bassa permeabilità al gas.

3. Cartuccia esterna in Nylon (Poliammide 6.6)

Campo di utilizzo per temperature fino a 90°C: la cartuccia in Nylon possiede ottime caratteristiche di resistenza meccanica accoppiate a grande tenacità ed elevata resistenza all'urto.

ISTRUZIONI DI INSTALLAZIONE



Attenzione

- Verificare il corretto verso della cartuccia.
- Coppia di serraggio consigliata da 25 a 30 Nm max.

Per il corretto montaggio dei collegamenti rigidi sottolavabo è necessario attenersi alla sequenza sopra indicata, verificando



scrupolosamente il verso di assemblaggio di cartuccia e guarnizioni. È quindi importante collegare per prima cosa il nipplo con rosetta alla rete idrica, inserire correttamente le eventuali guarnizioni tra la curvetta e il nipplo, inserire la cartuccia RCC all'interno del dado di serraggio facendo attenzione al verso di inserimento e in fine serrare il raccordo al tubetto.

TUBETTI RAME CROMATO

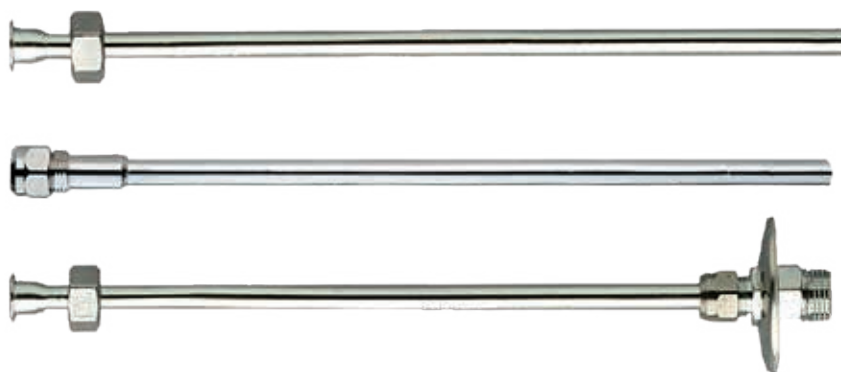

I tubetti in rame cromato Luxor Spa vengono utilizzati per collegare i rubinetti o i miscelatori alla rete idrica. In particolare si utilizzano dove i collegamenti sottolavabo restano scoperti ed è di conseguenza necessario un grado estetico elevato.

Si utilizzano inoltre dove non ci sono lunghezze di collegamento predefinite, lasciando quindi la possibilità all'installatore di rendere la lunghezza dei tubetti rame idonea ad ogni situazione.

Applicazioni:

- Lavabi aperti, con collegamenti a vista, senza coperture
- Bidet aperti, con collegamenti a vista, senza coperture
- Applicazioni personalizzate con ingombri specifici

- Lavabi con comandi a pedale
- Casette di scarico WC esterne

I tubetti cromati Luxor Spa sono realizzati in rame disossidato al 99,9%. La cartellatura delle estremità è doppia per garantire una maggiore resistenza in fase di collegamento.

Tutte le cannette vengono sbavate, lucidate e cromate al fine di distribuire un prodotto di immediato utilizzo e con un'ottima finitura estetica. La serie di tubetti in rame cromati Luxor Spa è corredata da accessori come raccordi a compressione, riduzioni e rosette copri foro.

**TUB 001**

Tubetto in rame cromato con flangia ricavata, raccordo a compressione e cartuccia a 3 pezzi.

CODICE	RACCORDI	A	B	C	D	E	F	G	H	L			
05060125CC	M 3/8 - F 3/8	14	10	17	19	19	G 3/8	G 3/8	-	250	107	-	20
05060130CC		14	10	17	19	19	G 3/8	G 3/8	-	300	116	-	20
05060135CC		14	10	17	19	19	G 3/8	G 3/8	-	350	125	-	20
05060140CC		14	10	17	19	19	G 3/8	G 3/8	-	400	134	10	-
05060150CC		14	10	17	19	19	G 3/8	G 3/8	-	500	152	10	-
05060170CC		14	10	17	19	19	G 3/8	G 3/8	-	700	188	10	-
05060199CC		14	10	17	19	19	G 3/8	G 3/8	-	1000	242	10	-

05060225CC	M 3/8 - F 1/2	18	10	17	19	23	G 3/8	G 1/2	-	250	109	-	20
05060230CC		18	10	17	19	23	G 3/8	G 1/2	-	300	118	-	20
05060235CC		18	10	17	19	23	G 3/8	G 1/2	-	350	127	-	20
05060240CC		18	10	17	19	23	G 3/8	G 1/2	-	400	136	10	-
05060250CC		18	10	17	19	23	G 3/8	G 1/2	-	500	154	10	-
05060270CC		18	10	17	19	23	G 3/8	G 1/2	-	700	190	10	-
05060299CC		18	10	17	19	23	G 3/8	G 1/2	-	1000	244	10	-

05060325CC	M 1/2 - F 3/8	14	10	21	19	19	G 1/2	G 3/8	-	250	114	-	20
05060330CC		14	10	21	19	19	G 1/2	G 3/8	-	300	123	-	20
05060335CC		14	10	21	19	19	G 1/2	G 3/8	-	350	132	-	20
05060340CC		14	10	21	19	19	G 1/2	G 3/8	-	400	141	10	-
05060350CC		14	10	21	19	19	G 1/2	G 3/8	-	500	159	10	-
05060370CC		14	10	21	19	19	G 1/2	G 3/8	-	700	195	10	-
05060399CC		14	10	21	19	19	G 1/2	G 3/8	-	1000	249	10	-

05060425CC	M 1/2 - F 1/2	18	10	21	19	23	G 1/2	G 1/2	-	250	116	-	20
05060430CC		18	10	21	19	23	G 1/2	G 1/2	-	300	125	-	20
05060435CC		18	10	21	19	23	G 1/2	G 1/2	-	350	136	-	20
05060440CC		18	10	21	19	23	G 1/2	G 1/2	-	400	143	10	-
05060450CC		18	10	21	19	23	G 1/2	G 1/2	-	500	161	10	-
05060470CC		18	10	21	19	23	G 1/2	G 1/2	-	700	197	10	-
05060499CC		18	10	21	19	23	G 1/2	G 1/2	-	1000	251	10	-

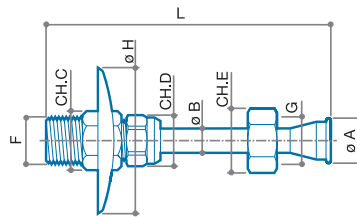

TUB 002

Tubetto in rame cromato con flangia ricavata, raccordo a compressione, cartuccia a 3 pezzi, maschio prolungato e rosetta scorrevole.

CODICE	RACCORDI	A	B	C	D	E	F	G	H	L			
05070125CC	MPR 3/8 - F 3/8	14	10	17	19	19	G 3/8	G 3/8	60	250	125	-	20
05070130CC		14	10	17	19	19	G 3/8	G 3/8	60	300	134	-	20
05070135CC		14	10	17	19	19	G 3/8	G 3/8	60	350	143	-	20
05070140CC		14	10	17	19	19	G 3/8	G 3/8	60	400	152	10	-
05070150CC		14	10	17	19	19	G 3/8	G 3/8	60	500	170	10	-
05070170CC		14	10	17	19	19	G 3/8	G 3/8	60	700	206	10	-
05070199CC		14	10	17	19	19	G 3/8	G 3/8	60	1000	260	10	-

05070225CC	MPR 3/8 - F 1/2	18	10	17	19	23	G 3/8	G 1/2	60	250	127	-	20
05070230CC		18	10	17	19	23	G 3/8	G 1/2	60	300	136	-	20
05070235CC		18	10	17	19	23	G 3/8	G 1/2	60	350	145	-	20
05070240CC		18	10	17	19	23	G 3/8	G 1/2	60	400	154	10	-
05070250CC		18	10	17	19	23	G 3/8	G 1/2	60	500	172	10	-
05070270CC		18	10	17	19	23	G 3/8	G 1/2	60	700	208	10	-
05070299CC		18	10	17	19	23	G 3/8	G 1/2	60	1000	262	10	-

05070325CC	MPR 1/2 - F 3/8	14	10	21	19	19	G 1/2	G 3/8	60	250	135	-	20
05070330CC		14	10	21	19	19	G 1/2	G 3/8	60	300	144	-	20
05070335CC		14	10	21	19	19	G 1/2	G 3/8	60	350	153	-	20
05070340CC		14	10	21	19	19	G 1/2	G 3/8	60	400	162	10	-
05070350CC		14	10	21	19	19	G 1/2	G 3/8	60	500	180	10	-
05070370CC		14	10	21	19	19	G 1/2	G 3/8	60	700	216	10	-
05070399CC		14	10	21	19	19	G 1/2	G 3/8	60	1000	270	10	-

05070425CC	MPR 1/2 - F 1/2	18	10	21	19	23	G 1/2	G 1/2	60	250	137	-	20
05070430CC		18	10	21	19	23	G 1/2	G 1/2	60	300	146	-	20
05070435CC		18	10	21	19	23	G 1/2	G 1/2	60	350	155	-	20
05070440CC		18	10	21	19	23	G 1/2	G 1/2	60	400	164	10	-
05070450CC		18	10	21	19	23	G 1/2	G 1/2	60	500	182	10	-
05070470CC		18	10	21	19	23	G 1/2	G 1/2	60	700	218	10	-
05070499CC		18	10	21	19	23	G 1/2	G 1/2	60	1000	272	10	-

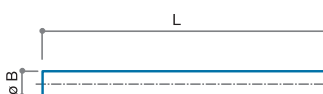

TUB 003

Tubetto in rame ricotto e cromato dritto senza flangiatura.

CODICE	RACCORDI	A	B	C	D	E	F	G	H	L			
05421000	Ø 10	-	10	-	-	-	-	-	-	1000	200	10	-
05421200	Ø 12	-	12	-	-	-	-	-	-	1000	222	10	-
05421400	Ø 14	-	14	-	-	-	-	-	-	1000	258	10	-



TUB 004

Tubetto in rame cromato con raccordo maschio.

CODICE	RACCORDI	A	B	C	D	E	F	G	H	L			
05012230	Ø 10 - M 10 x 1	-	10	-	-	12	M 10 x 1	-	-	300	66	10	-
05012240		-	10	-	-	12	M 10 x 1	-	-	400	87	10	-
05012260		-	10	-	-	-	12	M 10 x 1	-	-	600	126	10

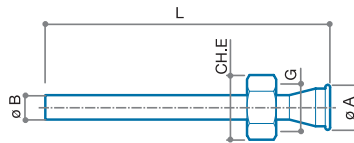

TUB 005

Tubetto in rame cromato con flangia ricavata e dado.

CODICE	RACCORDI	A	B	C	D	E	F	G	H	L			
05051720	Ø 10 - F 3/8	14	10	-	-	19	-	G 3/8	-	200	53	10	50
05051725		14	10	-	-	19	-	G 3/8	-	250	62	10	50
05051730		14	10	-	-	19	-	G 3/8	-	300	71	10	50
05051735		14	10	-	-	19	-	G 3/8	-	350	80	10	50
05051740		14	10	-	-	19	-	G 3/8	-	400	89	10	-
05051750		14	10	-	-	19	-	G 3/8	-	500	107	10	-
05051770		14	10	-	-	19	-	G 3/8	-	700	143	10	-
05051799		14	10	-	-	19	-	G 3/8	-	1000	197	10	-

05052120	Ø 10 - F 1/2	18	10	-	-	23	-	G 1/2	-	200	55	10	50
05052125		18	10	-	-	23	-	G 1/2	-	250	64	10	50
05052130		18	10	-	-	23	-	G 1/2	-	300	73	10	50
05052135		18	10	-	-	23	-	G 1/2	-	350	82	10	50
05052140		18	10	-	-	23	-	G 1/2	-	400	91	10	-
05052150		18	10	-	-	23	-	G 1/2	-	500	109	10	-
05052170		18	10	-	-	23	-	G 1/2	-	700	145	10	-
05052199		18	10	-	-	23	-	G 1/2	-	1000	199	10	-

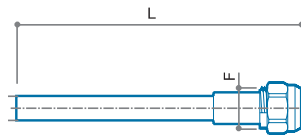

TUB 006

Tubetto in rame ricotto e cromato con raccordo a compressione e cartuccia a 3 pezzi.

CODICE	RACCORDI	A	B	C	D	E	F	G	H	L			
05100030CC	Ø 10 - RCC 3/8	-	10	-	-	19	G 3/8	-	-	300	86	10	50

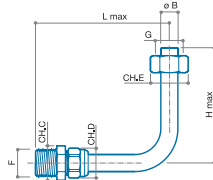

TUB 007

Curva in rame cromato completa di nipplo e raccordo a compressione, con cartuccia a 3 pezzi.

CODICE	RACCORDI	A	B	C	D	E	F	G	H	L			
05422112	M 1/2 - F 1/2	-	12	21	19	23	G 1/2	G 1/2	20	250	160	2	80
05422114		-	14	21	19	23	G 1/2	G 1/2	20	250	184	2	80

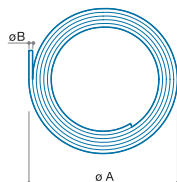

TUB 008

Rotolo di tubo pieghevole in rame ricotto e cromato.

CODICE	RACCORDI	A	B	C	D	E	F	G	H	L			
05401000	Ø 10	350	10	-	-	-	-	-	-	5000	920	-	1
05401200	Ø 12	350	12	-	-	-	-	-	-	5000	1.120	-	1

CURVETTE E SQUADRETTE SOTTOLAVABO



Le curvette e le squadrette sottolavabo Luxor spa vengono utilizzate per facilitare il collegamento tra i tubetti rame e la rete idrica. Questi articoli trovano maggiore utilizzo nelle applicazioni scoperte, dove i collegamenti restano visibili anche dopo l'installazione.

Applicazioni:

- Lavabi aperti, con collegamenti a vista, senza coperture
- Bidet aperti, con collegamenti a vista, senza coperture
- Applicazioni personalizzate con ingombri specifici
- Ogni collegamento generico dei tubetti rame

Le curvette sottolavabo Luxor Spa sono realizzate per il collegare le cannette in rame alla rete idrica.

Questa serie di articoli è stata progettata con interessanti accorgimenti tecnici che permettono agli utilizzatori una rapida e semplice installazione essendo regolabili in profondità e orientabili in angolazione.

La serie di curvette e squadrette sottolavabo Luxor Spa è corredata da accessori come raccordi a compressione, riduzioni e rosette copri foro.



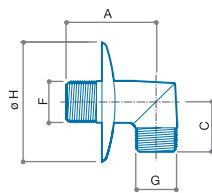

CHROME

BLACK



ET 001

Curvetta fissa per doccia 90° Serie 50th con rosetta scorrevole.

CODICE	RACCORDI	FINITURA	A	B	C	D	E	F	G	H	L			
85620001	M 1/2 - M 1/2	CHROME	45	-	25	-	-	G 1/2	G 1/2	68	-	50	10	100
85620002	M 1/2 - M 1/2	CHROME	45	-	25	-	-	G 1/2	G 1/2	55	-	50	25	200
85620003C	M 1/2 - M 1/2	CHROME	45	-	25	-	-	G 1/2	G 1/2	60	-	50	1	45
85620003N	M 1/2 - M 1/2	BLACK	45	-	25	-	-	G 1/2	G 1/2	60	-	50	1	45

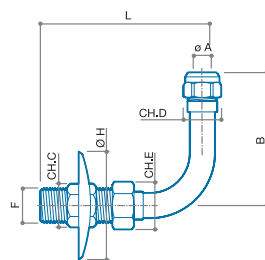

ET 002

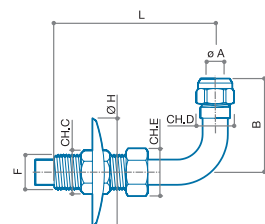

Curvetta fissa 90° in rame cromato per tubo Ø 10 mm con rosetta scorrevole e cartuccia a 3 pezzi.

CODICE	RACCORDI	A	B	C	D	E	F	G	H	L			
05391700CC	MPR 3/8 - RCC 3/8	10	78	21	19	23	G 3/8	-	60	82	130	10	100
05392100CC	MPR 1/2 - RCC 3/8	10	78	21	19	23	G 1/2	-	60	82	134	10	100





ET 003

Curvetta sfilabile 90° in rame cromato, per tubo Ø 10 mm con rosetta scorrevole e cartuccia a 3 pezzi.

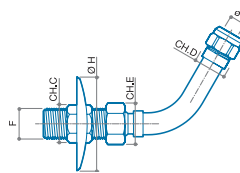
CODICE	RACCORDI	A	B	C	D	E	F	G	H	L			
05392115CC	MPR 1/2 - RCC 3/8	10	60	21	19	23	G 1/2	-	60	120	154	10	100

**ET 004**

Curveta orientabile con snodo in rame cromato per tubo \varnothing 10 mm con rosetta scorrevole e cartuccia a 3 pezzi.

CODICE	RACCORDI	A	B	C	D	E	F	G	H	L			
05392125CC	MPR 1/2 - RCC 3/8	10	-	21	19	23	G 1/2	-	60	-	158	10	100

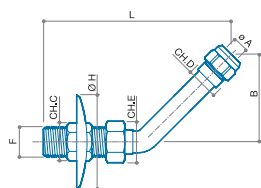

**ET 005**

Curveta fissa 45° in rame cromato per tubo \varnothing 10 mm con rosetta scorrevole e cartuccia a 3 pezzi.

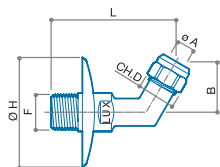
CODICE	RACCORDI	A	B	C	D	E	F	G	H	L			
05391735CC	MPR 3/8 - RCC 3/8	10	60	21	19	23	G 3/8	-	60	120	134	10	100
05392135CC	MPR 1/2 - RCC 3/8	10	60	21	19	23	G 1/2	-	60	120	138	10	100



**ET 006**

Squadretta fissa 60° in ottone stampato cromato per tubo \varnothing 10 mm con rosetta scorrevole e cartuccia a 3 pezzi.

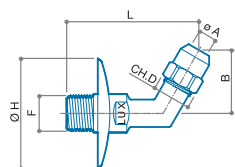
CODICE	RACCORDI	A	B	C	D	E	F	G	H	L			
05142101CC	MPR 1/2 - RCC 3/8	10	29	-	19	-	G 1/2	-	60	70	98	10	100

**ET 007**

Squadretta fissa 60° in ottone stampato cromato per tubo \varnothing 10 mm con rosetta scorrevole e cartuccia a 3 pezzi dado alto.

CODICE	RACCORDI	A	B	C	D	E	F	G	H	L			
05142102CC	MPR 1/2 - RCC 3/8	10	35	-	19	-	G 1/2	-	60	72	105	10	100

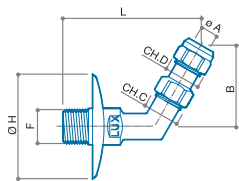

ET 008

Squadretta fissa 60° in ottone stampato cromato per tubo ø 10 mm con rosetta scorrevole, cartuccia a 3 pezzi e prolunga.

CODICE	RACCORDI	A	B	C	D	E	F	G	H	L			
05152101CC	MPR 1/2 - RCC 3/8	10	48	19	19	-	G 1/2	-	60	82	124	10	100

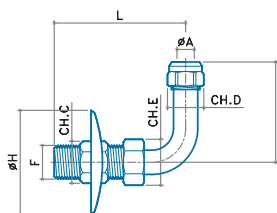

ET 009

Curvetta fissa 90° in ottone cromato per tubo ø 10 mm con rosetta scorrevole e cartuccia a 3 pezzi.

CODICE	RACCORDI	A	B	C	D	E	F	G	H	L			
05391710CC	MPR 3/8 - RCC 3/8	10	57	21	19	23	G 3/8	-	60	76	138	10	100
05392110CC	MPR 1/2 - RCC 3/8	10	57	21	19	23	G 1/2	-	60	76	138	10	100

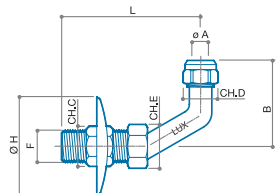

ET 010

Squadretta fissa 90° in ottone stampato cromato per tubo ø 10 mm con rosetta scorrevole e cartuccia a 3 pezzi.

CODICE	RACCORDI	A	B	C	D	E	F	G	H	L			
05391750CC	MPR 3/8 - RCC 3/8	10	55	21	19	23	G 3/8	-	60	78	144	10	100
05392150CC	MPR 1/2 - RCC 3/8	10	55	21	19	23	G 1/2	-	60	78	144	10	100

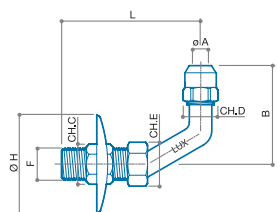

ET 011

Squadretta fissa 90° in ottone stampato cromato per tubo ø 10 mm con rosetta scorrevole e cartuccia 3 pezzi dado alto.

CODICE	RACCORDI	A	B	C	D	E	F	G	H	L			
05392160CC	MPR 1/2 - RCC 3/8	10	62	21	19	23	G 1/2	-	60	78	151	10	100

RACCORDI A COMPRESSIONE

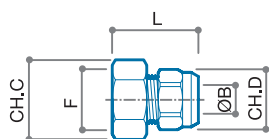

PR 001

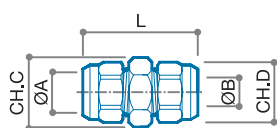

Raccordo femmina a compressione in ottone cromato per collegamento tubetti rame \varnothing 10 mm e \varnothing 12 mm.

CODICE	RACCORDI	A	B	C	D	E	F	G	H	L			
Cartuccia a tre pezzi													
05301710CC	F 3/8 - RCC 3/8	-	10	20	19	-	G 3/8	-	-	30	40	30	-
05302110CC	F 1/2 - RCC 3/8	-	10	24	19	-	G 1/2	-	-	30	45	30	-
Ogiva teflon													
05301712	F 3/8 - RCO 3/8	-	12	20	19	-	G 3/8	-	-	30	29	30	-
05302112	F 1/2 - RCO 3/8	-	12	24	19	-	G 1/2	-	-	30	40	30	-



PR 002

Raccordo nipplo a compressione in ottone cromato per collegamento tubetti rame \varnothing 10 mm e \varnothing 12 mm.

CODICE	RACCORDI	A	B	C	D	E	F	G	H	L			
Cartuccia a tre pezzi													
05291710CC	RCC 3/8 - RCC 3/8	10	10	17	-	-	-	-	-	40	55	30	-
Ogiva teflon													
05291712	RCO 3/8 - RCO 3/8	12	12	17	-	-	-	-	-	40	44	30	-

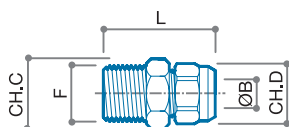

PR 003

Raccordo maschio a compressione in ottone cromato per collegamento tubetti rame.

CODICE	RACCORDI	A	B	C	D	E	F	G	H	L			
Cartuccia a tre pezzi													
05321710CC	M 3/8 - RCC 3/8	-	10	17	19	-	G 3/8	-	-	40	45	30	-
05322110CC	M 1/2 - RCC 3/8	-	10	21	19	-	G 1/2	-	-	40	50	30	-
Ogiva teflon													
05321712	M 3/8 - RCO 3/8	-	12	17	19	-	G 3/8	-	-	40	35	30	-
05322112	M 1/2 - RCO 3/8	-	12	21	19	-	G 1/2	-	-	40	46	30	-
05322114	M 1/2 - RCO 1/2	-	14	21	19	-	G 1/2	-	-	40	56	20	-

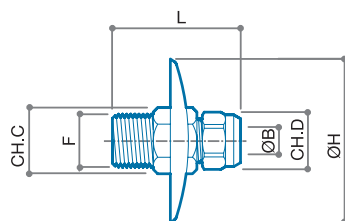

PR 004



Raccordo maschio prolungato a compressione in ottone cromato con rosetta scorrevole per collegamento tubetti rame.

CODICE	RACCORDI	A	B	C	D	E	F	G	H	L			
05311701CC	MPR 3/8 - RCC 3/8	-	10	17	19	-	G 3/8	-	60	48	63	20	-
05312101CC	MPR 1/2 - RCC 3/8	-	10	21	19	-	G 1/2	-	60	48	73	20	200

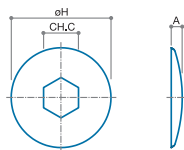
ROSETTE

**ROS 001**

Rosetta scorrevole in acciaio inox
 ϕ 60 mm con foro esagonale.

CODICE	RACCORDI	A	B	C	D	E	F	G	H	L			
30011700CF	G 3/8	6	-	17	-	-	-	-	60	-	9	10	-
30012100CF	G 1/2	6	-	21	-	-	-	-	60	-	8	10	-

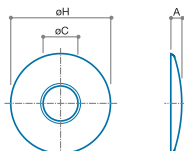

**ROS 002**

Rosetta in acciaio inox ϕ 60 mm
 con foro rotondo.

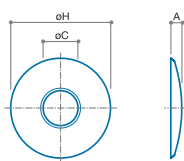
CODICE	RACCORDI	A	B	C	D	E	F	G	H	L			
30031700CF	G 3/8	6	-	17	-	-	-	-	60	-	9	50	-
30032100CF	G 1/2	6	-	21	-	-	-	-	60	-	8	50	-
30032700CF	G 3/4	6	-	27	-	-	-	-	60	-	7	-	50
30033400CF	G 1"	6	-	34	-	-	-	-	60	-	6	-	50

**ROS 003**

Rosetta scorrevole in ottone cromato
 ϕ 55 mm con foro rotondo.

CODICE	RACCORDI	A	B	C	D	E	F	G	H	L			
30051700CF	G 3/8	6	-	17	-	-	-	-	55	-	7	50	-
30052100CF	G 1/2	6	-	21	-	-	-	-	55	-	6	50	-

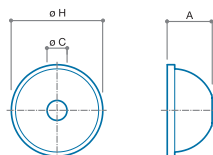

**ROS 004**

Rosetta a campana in ottone cromato
 ϕ 55 mm.

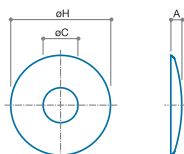
CODICE	RACCORDI	A	B	C	D	E	F	G	H	L			
05260010CF	ϕ 10	27	-	10	-	-	-	-	55	-	14	-	50
05260012CF	ϕ 12	27	-	12	-	-	-	-	55	-	13	-	50
05260014CF	ϕ 14	27	-	14	-	-	-	-	55	-	12	-	50

**ROS 005**

Rosetta scorrevole in acciaio inox
 ϕ 57 mm con alette.

CODICE	RACCORDI	A	B	C	D	E	F	G	H	L			
30152100CF	G 1/2	8	-	21	-	-	-	-	57	-	9	50	-



6 / RUBINETTI

RUBINETTI



I rubinetti di intercettazione Luxor Spa sono prodotti di alta qualità che trovano spazio in diversi campi di applicazione: dal consolidato utilizzo sottolavabo al collegamento delle cassette scarico WC passando per la connessione delle lavatrici e delle lavastoviglie.

Ai rubinetti di intercettazione Luxor Spa si possono collegare sia tubetti in rame cromato che tubi flessibili. I rubinetti Luxor Spa sono versatili, sicuri e facili da installare.

CAMPI DI APPLICAZIONE



lavabi



bidet



cassette di scarico



lavastoviglie



lavatrici

GAMMA

La gamma di rubinetti Luxor Spa copre ogni tipo di applicazione idrosanitaria e soddisfa i bisogni degli utilizzatori: versatili, facili da installare e garantiti nel tempo.

I rubinetti Luxor Spa possono avere la chiusura a vitone oppure a sfera, il tappo di ispezione e il filtro, i raccordi di collegamento orientabili.

Tutti i rubinetti Luxor Spa sono verificati a pressione per garantirne la corretta tenuta. I rubinetti Luxor Spa sono corredate da accessori come raccordi a compressione, riduzioni e rosette copri foro.

**Starx**

Rubinetti a vitone con filtro

**Deltax**

Rubinetti a vitone senza filtro

**Spheralux**

Rubinetti sottolavabo a sfera

**Serie 50TH**

Rubinetti sottolavabo d'arredo

**Serie SC**

Rubinetti per cassetta scarico

**Serie K**

Rubinetti per elettrodomestici

**Serie G**

Rubinetti a galleggiante



LUXOR®

RUBINETTI

6.1 / STARX

STARX

RUBINETTI A VITONE CON FILTRO



I rubinetti a vitone con filtro serie STARX sono prodotti di alta qualità che trovano spazio in diversi campi di applicazione oltre al consolidato utilizzo sottolavabo.

Possono essere collegati sia tubetti in rame cromato che tubi flessibili: i rubinetti STARX sono versatili, sicuri e facili da installare.

CARATTERISTICHE TECNICHE

		
Max temperatura	Max pressione	Materiale
90 °C	10 bar	CW617N
		
Manopola	Collaudo	Istruzioni di installazione
ABS	100%	Pag. 475

CAMPI DI APPLICAZIONE

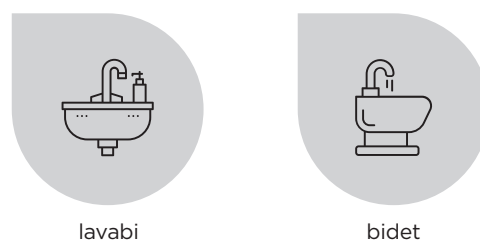

lavabi

bidet



VITONE IN NYLON

Il vitone è realizzato in Nylon (Poliammide 6.6). Oltre alle ottime qualità igieniche, il vitone possiede elevate proprietà meccaniche che gli permettono di lavorare senza alcuna alterazione di funzionamen-

to ad alte e basse temperature, e gli permettono di resistere alle sollecitazioni di trazione, torsione e urto a cui potrebbe essere sottoposto il rubinetto durante il suo normale utilizzo.

LA GAMMA

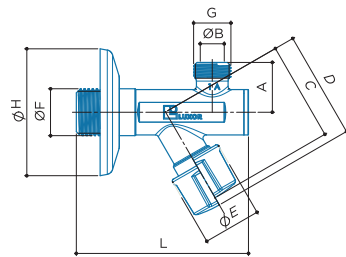

S 19

Rubinetto sottolavabo a vitone con filtro e rosetta scorrevole.

CODICE	MISURA	A	B	C	D	E	F	G	H	L	M	N	P			
70502100	G 1/2 - G 3/8	22	10	44	47,5	25,6	G 1/2	G 3/8	56	76	-	-	-	141	10	100

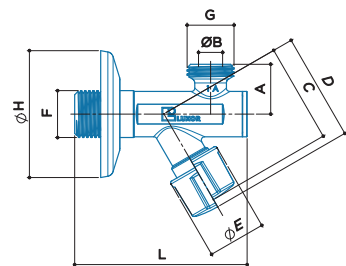

S 20

Rubinetto sottolavabo a vitone con filtro e rosetta scorrevole.

CODICE	MISURA	A	B	C	D	E	F	G	H	L	M	N	P			
70512100	G 1/2 - G 1/2	22	10	44	47,5	25,6	G 1/2	G 1/2	56	76	-	-	-	144	10	100

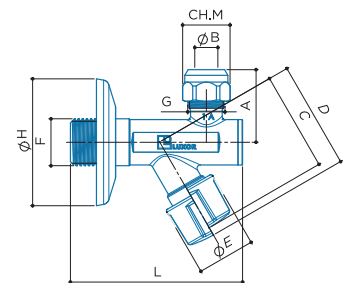

S 23

Rubinetto sottolavabo a vitone con filtro, rosetta scorrevole e cartuccia a 3 pezzi.

CODICE	MISURA	A	B	C	D	E	F	G	H	L	M	N	P			
70502101CC	G 1/2 - G 3/8	32	10	44	47,5	25,6	G 1/2	G 3/8	56	76	19	-	-	156	10	100

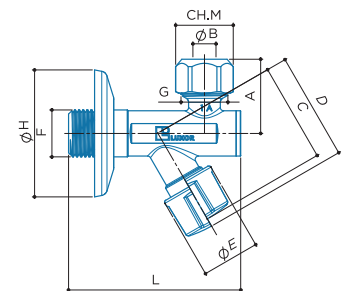

S 24

Rubinetto sottolavabo a vitone con filtro e rosetta scorrevole e ogiva in teflon.

CODICE	MISURA	A	B	C	D	E	F	G	H	L	M	N	P			
70512101	G 1/2 - G 1/2	33	10	44	47,5	25,6	G 1/2	G 1/2	56	76	23	-	-	169	10	100

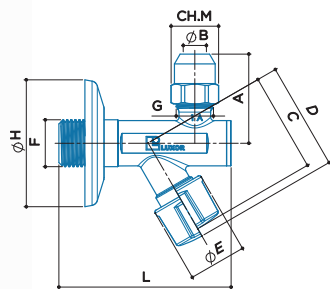

S 27

Rubinetto sottolavabo a vitone con filtro, rosetta scorrevole e cartuccia a 3 pezzi dado alto.

CODICE	MISURA	A	B	C	D	E	F	G	H	L	M	N	P			
70502102CC	G 1/2 - G 3/8	40	10	44	47,5	25,6	G 1/2	G 3/8	56	76	19	-	-	162	10	100

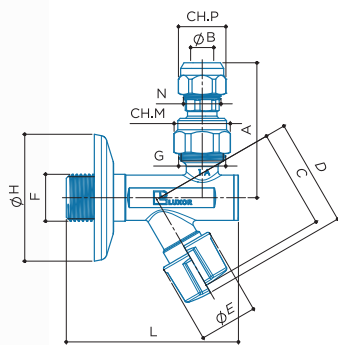

S 30

Rubinetto sottolavabo a vitone con filtro, rosetta scorrevole e cartuccia a 3 pezzi a uscita orientabile.

CODICE	MISURA	A	B	C	D	E	F	G	H	L	M	N	P			
70512111CC	G 1/2 - G 3/8	60	10	44	47,5	25,6	G 1/2	G 1/2	56	76	23	G 3/8	19	198	10	100

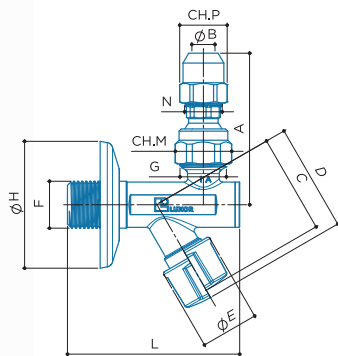

S 31

Rubinetto sottolavabo a vitone con filtro, rosetta scorrevole e cartuccia a 3 pezzi dado alto a uscita orientabile.

CODICE	MISURA	A	B	C	D	E	F	G	H	L	M	N	P			
70512112CC	G 1/2 - G 3/8	67	10	44	47,5	25,6	G 1/2	G 1/2	56	76	23	G 3/8	19	205	10	100

DIAGRAMMA DI PORTATA

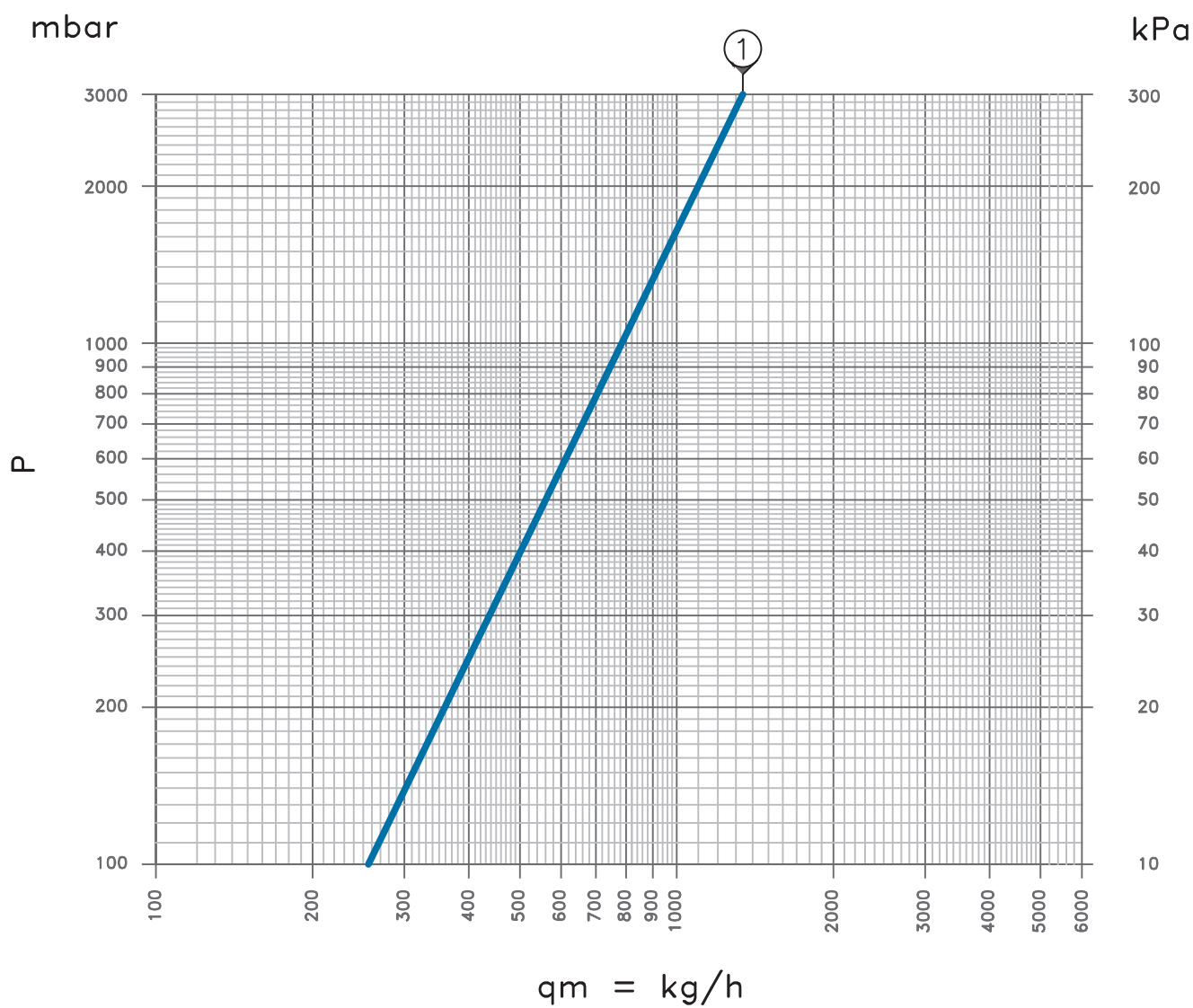

ARTICOLI	CODICE	Kv
S 19	70502100	0,75
S 20	70512100	
S 23	70502101CC	
S 24	70512101	
S 27	70502102CC	
S 30	70512111CC	
S 31	70512112CC	



LUXOR®

RUBINETTI

6.2 / DELTAX

DELTAX

RUBINETTI A VITONE SENZA FILTRO



I rubinetti a vitone Luxor Spa offrono tutta la qualità e la garanzia del prodotto Made in Italy. La gamma di prodotti comprende rubinetti, corpi a dimensione compatta e raccordi di

uscita direzionabili per favorirne il collegamento in ogni condizione di lavoro.

CARATTERISTICHE TECNICHE



Max temperatura

90 °C



Max pressione

10 bar



Materiale

CW617N



Manopola

ABS



Collaudo

100%



Istruzioni di
installazione
Pag. 475

CAMPI DI APPLICAZIONE



lavabi



bidet

VITONE IN NYLON

Il vitone è realizzato in Nylon (Poliammide 6.6). Oltre alle ottime qualità igieniche, il vitone possiede elevate proprietà meccaniche che gli permettono di lavorare senza alcuna alterazione di funzionamen-

to ad alte e basse temperature, e gli permettono di resistere alle sollecitazioni di trazione, torsione e urto a cui potrebbe essere sottoposto il rubinetto durante il suo normale utilizzo.

LA GAMMA

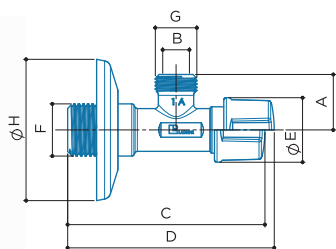

S 2

Rubinetto sottolavabo a vitone senza filtro con rosetta scorrevole.

CODICE	MISURA	A	B	C	D	E	F	G	H	L	M			
70202100	G 1/2 - G 3/8	22	10	78,2	81,9	25,6	G1/2	G3/8	56	-	-	93	10	100

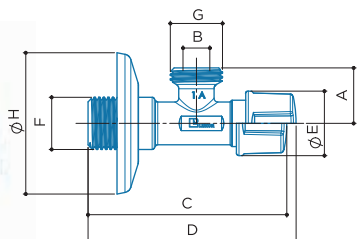

S 3

Rubinetto sottolavabo a vitone senza filtro con rosetta scorrevole.

CODICE	MISURA	A	B	C	D	E	F	G	H	L	M			
70212100	G 1/2 - G 1/2	22	10	78,2	81,9	25,6	G1/2	G1/2	56	-	-	97	10	100

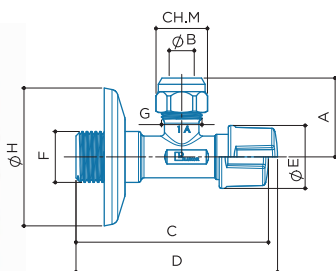

S 7

Rubinetto sottolavabo a vitone senza filtro con rosetta scorrevole e cartuccia a 3 pezzi.

CODICE	MISURA	A	B	C	D	E	F	G	H	L	M			
70202101CC	G 1/2 - G 3/8	32	10	78,2	81,9	25,6	G1/2	G3/8	56	-	19	108	10	100

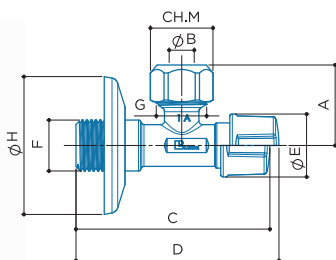

S 8

Rubinetto sottolavabo a vitone senza filtro con rosetta scorrevole e ogiva in teflon.

CODICE	MISURA	A	B	C	D	E	F	G	H	L	M			
70212101	G 1/2 - G 1/2	32,8	10	78,2	81,9	25,6	G1/2	G1/2	56	-	23	122	10	100

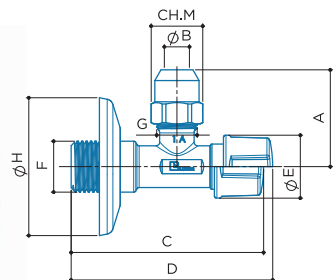

S 12

Rubinetto sottolavabo a vitone senza filtro con rosetta scorrevole e cartuccia a 3 pezzi dado alto.

CODICE	MISURA	A	B	C	D	E	F	G	H	L	M			
70202102CC	G 1/2 - G 3/8	39	10	78,2	81,9	25,6	G1/2	G3/8	56	-	19	113	10	100

DIAGRAMMA DI PORTATA

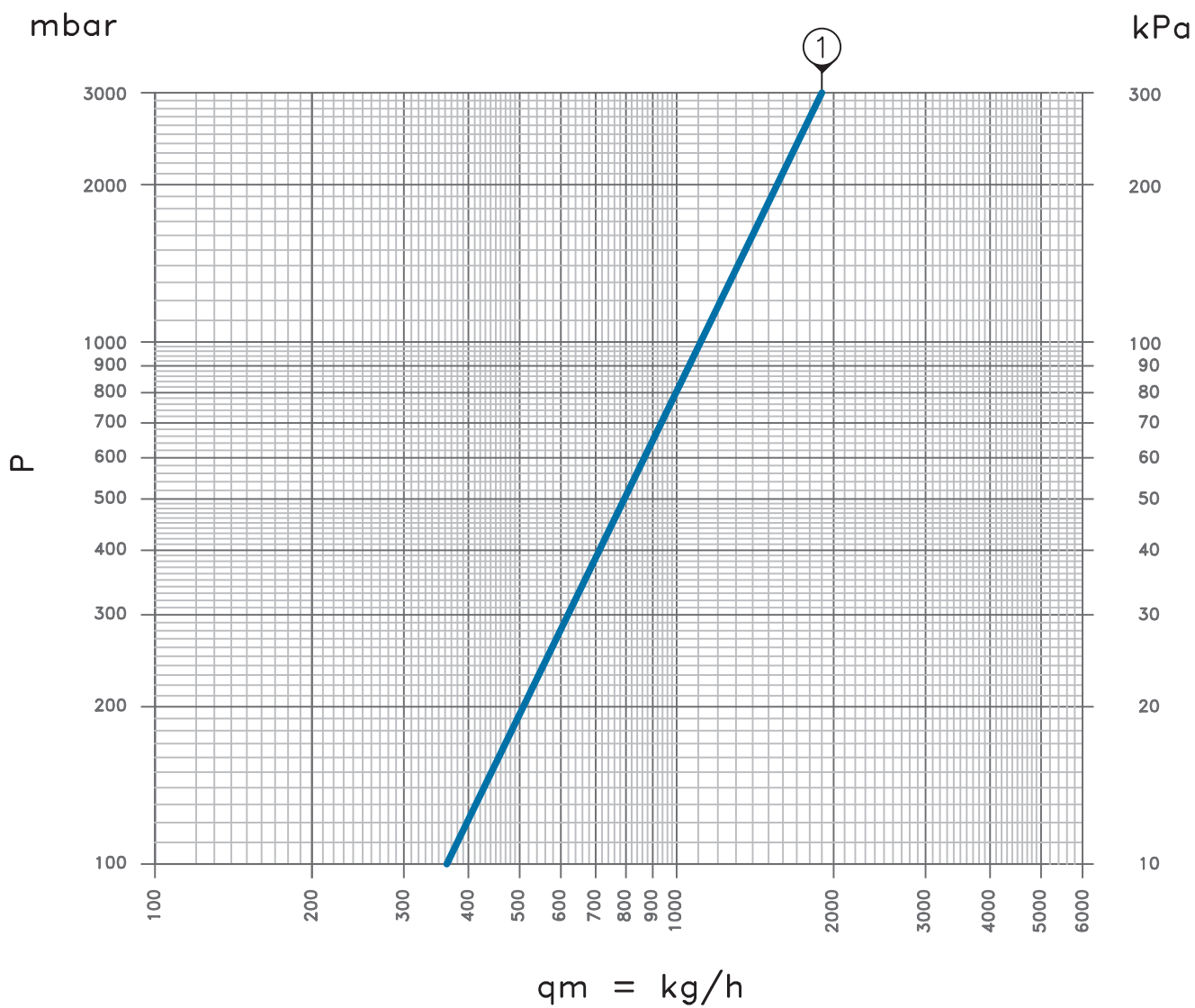

ARTICOLI	CODICE	Kv
S 2	70202100	1,1
S 3	70212100	
S 7	70202101CC	
S 8	70212101	
S 12	70202102CC	



LUXOR®

RUBINETTI

6.3 / SPHERALUX

SPHERALUX

RUBINETTI SOTTOLAVABO A SFERA



I rubinetti a sfera offrono la praticità della classica chiusura a corsa corta unita alla qualità e alla garanzia del prodotto Made in Italy.

La gamma di articoli comprende rubinetti standard e con uscita direzionabile attraverso raccordi snodabili che facilitano la loro installazione.

CARATTERISTICHE TECNICHE



Max temperatura

90 °C



Max pressione

10 bar



Materiale

CW617N



Manopola

ABS



Collaudo

100%



Istruzioni di
installazione
Pag. 475

CAMPI DI APPLICAZIONE



lavabi



bidet

SFERA E ASTA DI COMANDO

La sfera e l'asta di comando sono realizzate in ottone CW614N a basso contenuto di piombo in conformità alla normativa Europea UNI EN12164 che ne stabilisce le caratteristiche di composizione chimica. La tenuta della sfera è realizzata attraverso guarnizioni in PTFE vergine, mentre l'asta di comando utilizza a tale scopo

un sistema di sicurezza a doppio o-ring in EPDM, che preserva le sue caratteristiche di tenuta e di resistenza meccanica nel tempo. Tutte le guarnizioni utilizzate, PTFE ed EPDM, sono realizzate in conformità alle più rigide normative internazionali in materia di sanità e di sicurezza ambientale.

FILTRO

Il filtro è realizzato in acciaio inox AISI 304 resistente all'azione degli agenti atmosferici e all'ossidazione. L'apposito tappo di ispezione è dotato di un comodo intaglio per facilitare le operazioni di apertura/chiusura e per semplificare l'operazione di pulizia del filtro.

MANIGLIA

La maniglia, con la comoda chiusura a quarto di giro, è realizzata in ABS con finitura cromata e possiede elevate proprietà meccaniche che gli permettono di resistere alle sollecitazioni di trazione, torsione e urto a cui potrebbe essere sottoposto il rubinetto durante il suo normale utilizzo.

TENUTA GARANTITA

Tutti i rubinetti a sfera Luxor Spa vengono accuratamente controllati a pressione al 100% in linea durante la fase di assemblaggio degli articoli per garantirne la tenuta ed evitare possibili perdite dopo l'installazione finale.

LA GAMMA

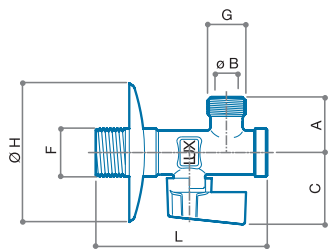
**V 35**

Rubinetto sottolavabo a sfera con filtro e rosetta scorrevole.

CODICE	MISURA	A	B	C	D	E	F	G	H	L	M	N	P			
70902100	G 1/2 - G 3/8	24	10	31	-	-	G 1/2	G 3/8	56	74	-	-	-	128	10	100

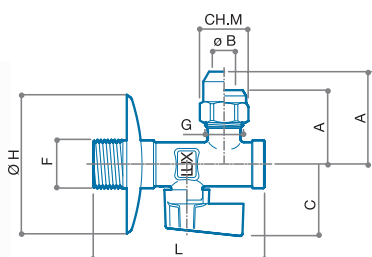
**V 43**

Rubinetto sottolavabo a sfera con filtro, con rosetta scorrevole e cartuccia a 3 pezzi dado alto.

CODICE	MISURA	A	B	C	D	E	F	G	H	L	M	N	P			
70902102CC	G 1/2 - G 3/8	40	10	31	-	-	G 1/2	G 3/8	56	74	19	-	-	148	10	100

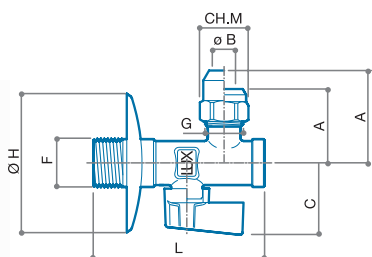
**V 39**

Rubinetto sottolavabo a sfera con filtro, con rosetta scorrevole e cartuccia a 3 pezzi.

CODICE	MISURA	A	B	C	D	E	F	G	H	L	M	N	P			
70902101CC	G 1/2 - G 3/8	32	10	31	-	-	G 1/2	G 3/8	56	74	19	-	-	142	10	100

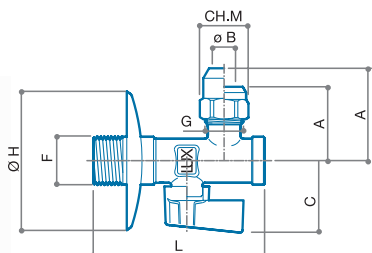

**V 40**

Rubinetto sottolavabo a sfera con filtro, con rosetta scorrevole e ogiva in teflon.

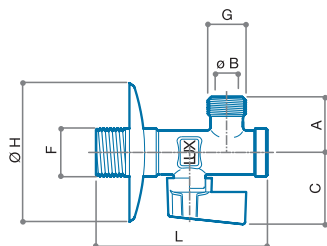
CODICE	MISURA	A	B	C	D	E	F	G	H	L	M	N	P			
70912101	G 1/2 - G 1/2	32	10	31	-	-	G 1/2	G 1/2	56	74	23	-	-	162	10	100



**V 36**

Rubinetto sottolavabo a sfera con filtro e rosetta scorrevole.

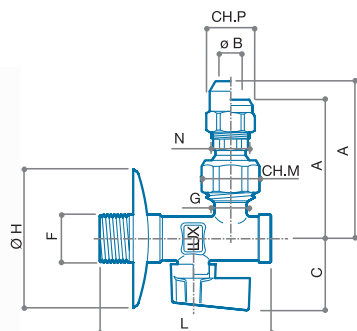
CODICE	MISURA	A	B	C	D	E	F	G	H	L	M	N	P			
70912100	G 1/2 - G 1/2	24	10	31	-	-	G 1/2	G 1/2	56	74	-	-	-	134	10	100

**V 46**

Rubinetto sottolavabo a sfera con filtro, con rosetta scorrevole e cartuccia a 3 pezzi a uscita orientabile.

CODICE	MISURA	A	B	C	D	E	F	G	H	L	M	N	P			
7091211CC	G 1/2 - G 3/8	62	10	31	-	-	G 1/2	G 1/2	56	74	23	G 3/8	19	192	10	100

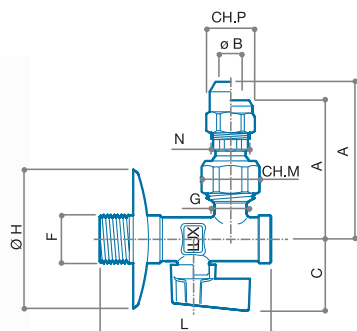
**V 47**

Rubinetto sottolavabo a sfera con filtro, con rosetta scorrevole e cartuccia a 3 pezzi dado alto a uscita orientabile.

CODICE	MISURA	A	B	C	D	E	F	G	H	L	M	N	P			
7091212CC	G 1/2 - G 3/8	68	10	31	-	-	G 1/2	G 1/2	56	74	23	G 3/8	19	198	10	100

ISTRUZIONI DI INSTALLAZIONE PER RUBINETTI STARX, DELTAX E SPHERALUX

Per il corretto montaggio dei collegamenti rigidi sottolavabo è necessario attenersi alla sequenza sotto indicata, verificando scrupolosamente il verso di assemblaggio di cartuccia e guarnizioni.

È quindi importante collegare per prima cosa il nipplo con rosetta alla rete idrica, inserire correttamente le eventuali guarnizioni tra la curvetta e il nipplo, inserire la cartuccia RCC

all'interno del dado di serraggio facendo attenzione al verso di inserimento e infine serrare il raccordo al tubetto.

Attenzione:

- **Verificare il corretto verso della cartuccia;**
- **Coppia di serraggio consigliata da 25 a 30 Nm max.**



DIAGRAMMA DI PORTATA



ARTICOLI	CODICE	Kv
V 35	70902100	1,20
V 36	70912100	
V 39	70902101CC	
V 40	70912101	
V 43	70902102CC	
V 46	70912111CC	
V 47	70912112CC	

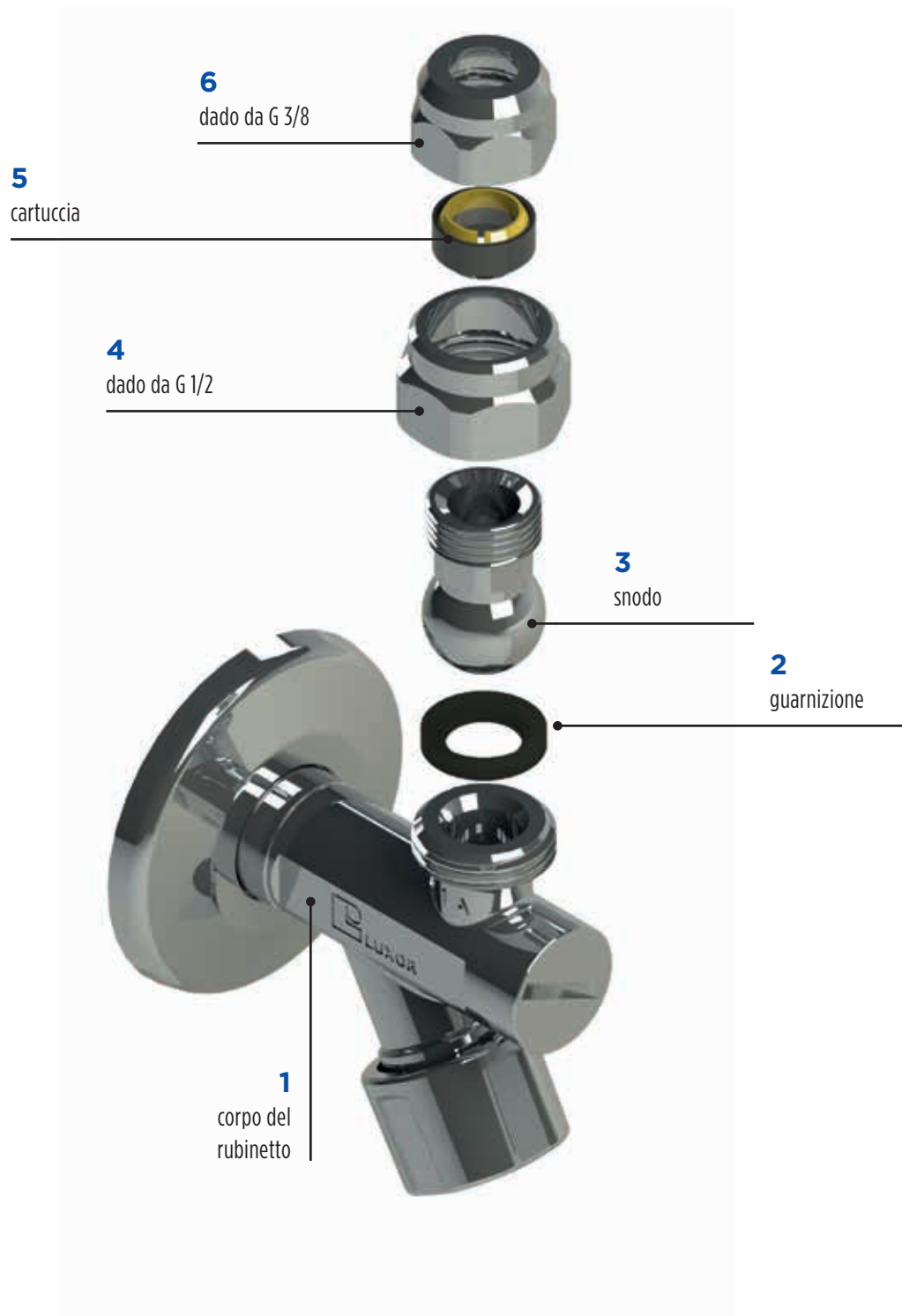
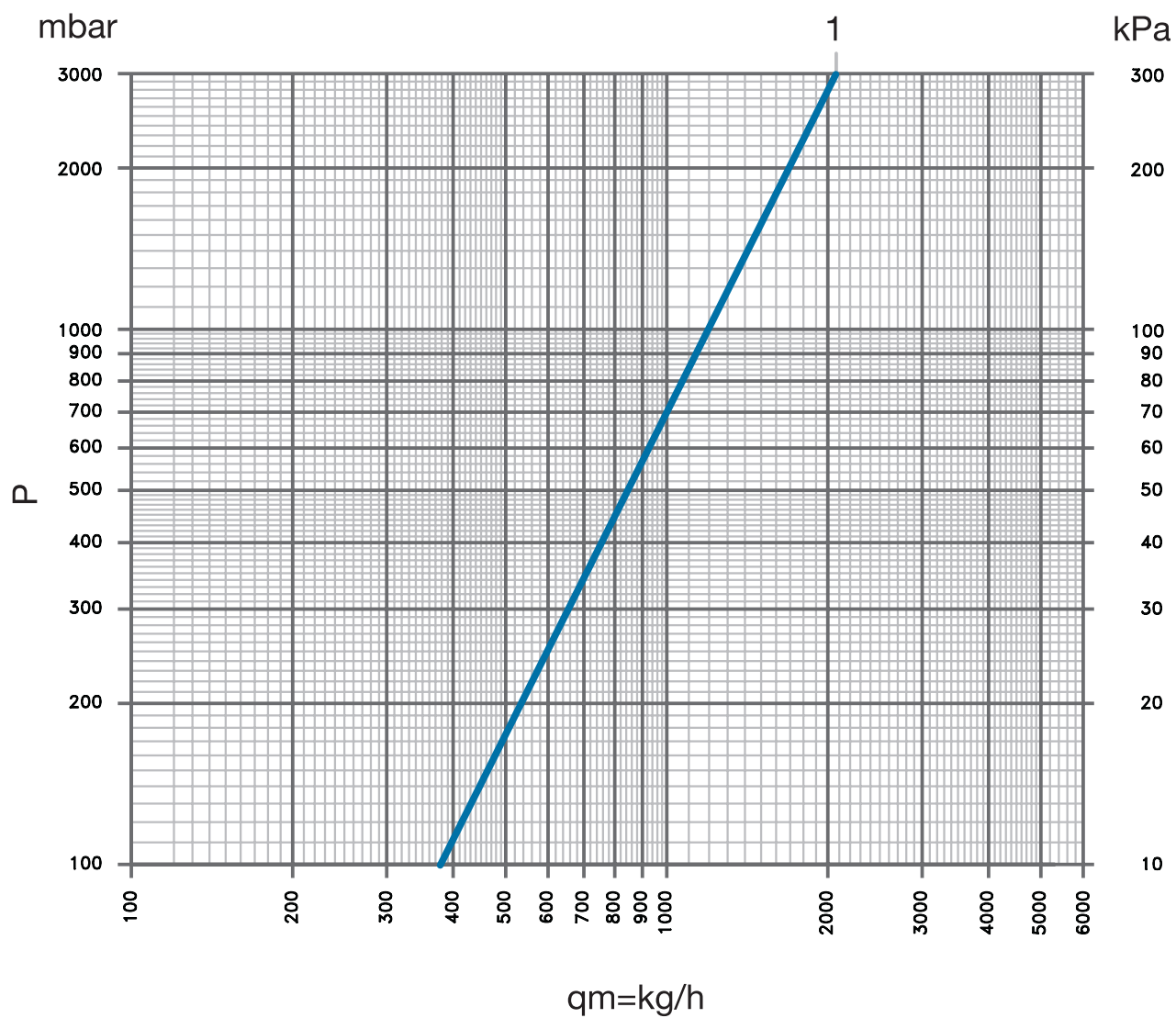

LUXOR®

RUBINETTI

6.4 / SERIE 50th

SERIE 50th

RUBINETTI SOTTOLAVABO D'ARREDO



Tutta la gamma di rubinetti Serie 50th viene prodotta con finitura cromata a telaio, garantendo ai prodotti la massima resistenza nel tempo. I corpi dei rubinetti vengono realizzati utilizzando ottone CW617N a basso contenuto di piombo. Il

vitone è realizzato in ottone CW614N e tutte le guarnizioni sono prodotte in EPDM perossidico. I rubinetti Serie 50th sono sottoposti ad doppio processo di lucidatura che permette l'ottenimento di una finitura eccellente.

CARATTERISTICHE TECNICHE



Max temperatura
90 °C



Max pressione
10 bar



Materiale
CW617N



Manopola
ABS

CAMPI DI APPLICAZIONE



lavabi



bidet

LA GAMMA

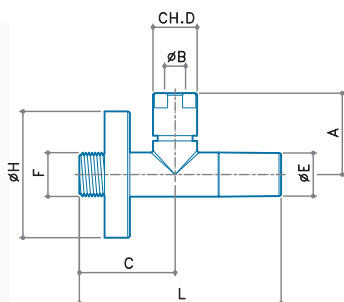

S 53

Kit composto da: 2 rubinetti dritti sottolavabo con asta fissa, rosetta scorrevole e cartuccia 3 pezzi.

CODICE	MISURA	FINITURA	A	B	C	D	E	F	G	H	L	M			
70952101CC	G 1/2 - G 3/8	CROMATO	39	10	46	19	21	G 1/2	-	60	96	-	400	1	12
70952101CCN	G 1/2 - G 3/8	NERO	39	10	46	19	21	G 1/2	-	60	96	-	400	1	12

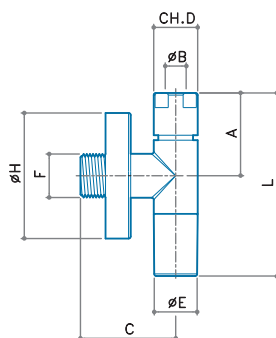

S 54

Kit composto da: 2 rubinetti a squadra sottolavabo con asta fissa, rosetta scorrevole e cartuccia 3 pezzi.

CODICE	MISURA	FINITURA	A	B	C	D	E	F	G	H	L	M			
70972101CC	G 1/2 - G 3/8	CROMATO	39	10	46	19	21	G 1/2	-	60	88	-	388	1	12
70972101CCN	G 1/2 - G 3/8	NERO	39	10	46	19	21	G 1/2	-	60	88	-	388	1	12

DIAGRAMMA DI PORTATA

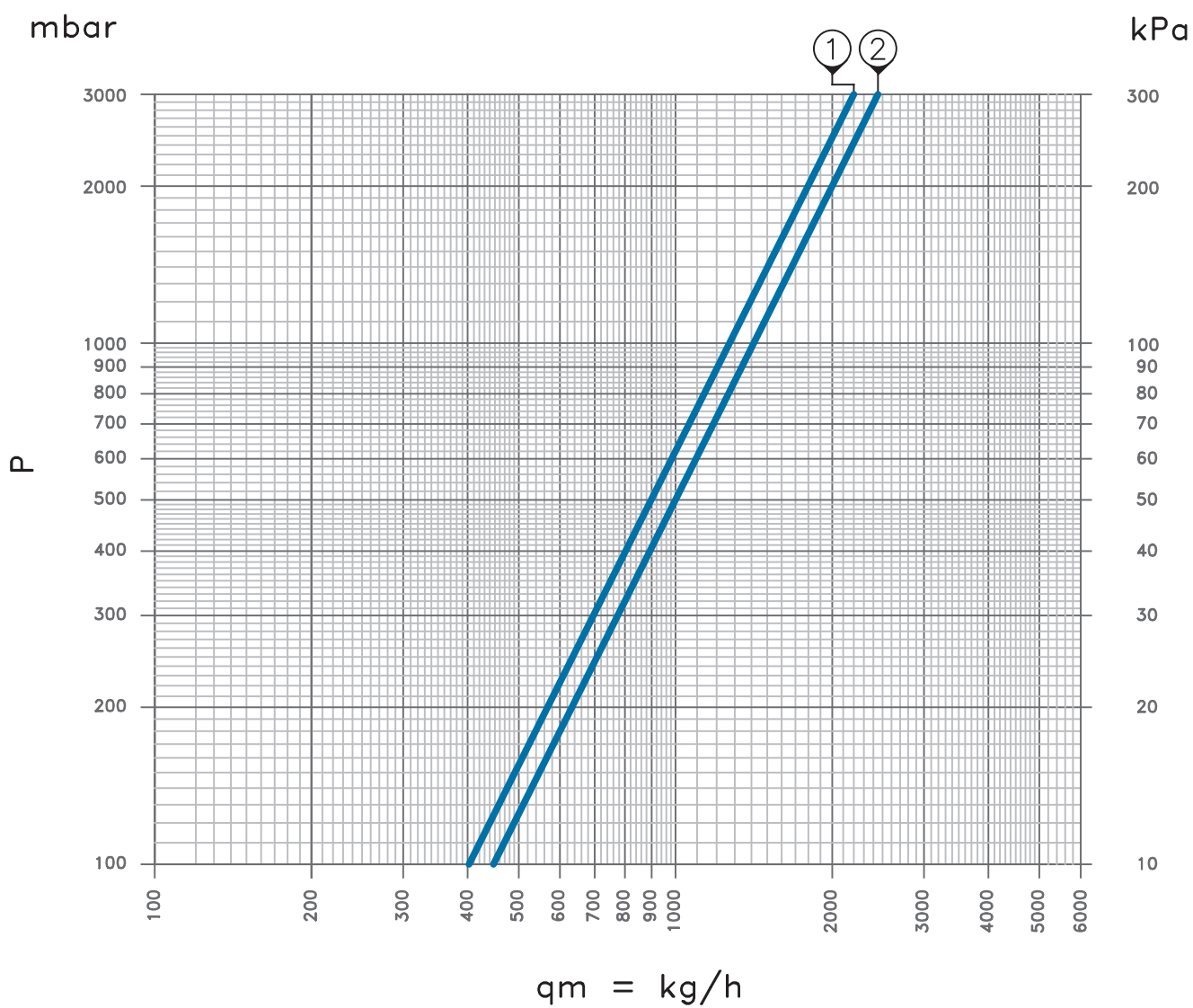

ARTICOLI	CODICE	CURVA	Kv
S 53	70952101CC	1	1,4
	70952101CCN		
S 54	70972101CC	2	1,45
	70972101CCN		



LUXOR®

RUBINETTI

6.5 / SERIE SC

SERIE SC

RUBINETTI PER CASSETTA SCARICO



La gamma di questi rubinetti viene utilizzata prevalentemente per collegare le cassette di scarico WC alla rete idrica. La gamma è composta, oltre che dal compatto rubinetto a vitone, da kit di assemblaggio con tubetti rame, raccordi a com-

pressione, nipli di collegamento e rosette. La completezza e la versatilità di questi prodotti facilita e semplifica le operazioni di installazione nelle più svariate condizioni di utilizzo.

CARATTERISTICHE TECNICHE



Max temperatura

90 °C



Max pressione

10 bar



Materiale

CW617N



Manopola

ABS



Collaudo

100%

CAMPI DI APPLICAZIONE



cassette di scarico

VITONE IN NYLON

Il vitone è realizzato in Nylon (Poliammide 6.6). Oltre alle ottime qualità igieniche, il vitone possiede elevate proprietà meccaniche che gli permettono di lavorare senza alcuna alterazione di funzionamen-

to ad alte e basse temperature, e gli permettono di resistere alle sollecitazioni di trazione, torsione e urto a cui potrebbe essere sottoposto il rubinetto durante il suo normale utilizzo.

TUBETTI

I tubetti di collegamento vengono realizzati utilizzando rame disossidato al fosforo qualità Cu-DHP con composizione chimica Cu 99,9% min, le cui caratteristiche meccaniche, dimensioni e tolleranze sono rispondenti alla norma EN1057 e norme ad essa collegate. Tutti i particolari realizzati vengono rigorosamente lavati in vasche ad ultrasuoni con agenti neutri che permettono di eliminare sostanze di lavorazione residue.

MANIGLIA

La maniglia ergonomica è realizzata in ABS con finitura cromata e possiede elevate proprietà meccaniche che gli permettono di resistere alle sollecitazioni di trazione, torsione e urto a cui potrebbe essere sottoposto il rubinetto durante il suo normale utilizzo.

ROSETTE

Le rosette sono realizzate in acciaio inox AISI 430 resistente all'azione degli agenti atmosferici, alle soluzioni alcaline degli acidi organici e all'ossidazione fino ad alte temperature.

LA GAMMA

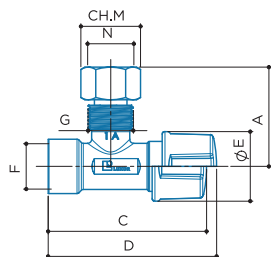

S 60

Rubinetto per cassetta di scarico.

CODICE	MISURA	A	B	C	D	E	F	G	H	L	N			
70600100	F 3/8 - M 3/8 - F 3/8	36	-	58,2	61,9	25,6	G 3/8	G 3/8	-	-	G 3/8	79	10	100

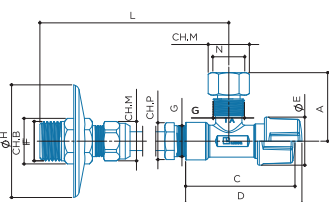

S 61

Rubinetto per cassetta di scarico con rosetta scorrevole, tubetto in rame cromato da 20cm e cartuccia a 3 pezzi.

CODICE	MISURA	A	B	C	D	E	F	G	H	L	M	N	P			
70600020CC	MPR 1/2 - F 3/8	36	21	58,2	61,9	25,6	G 1/2	G 3/8	60	208	19	G 3/8	17	206	10	80

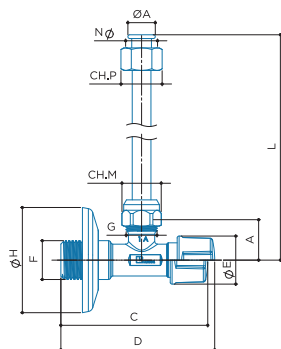

S 62

Rubinetto per cassetta di scarico con rosetta scorrevole, tubetto in rame cromato da 25cm e cartuccia a 3 pezzi.

CODICE	MISURA	A	B	C	D	E	F	G	H	L	M	N	P			
70601030CC	M 1/2 - F 3/8	14	-	78,2	81,9	25,6	G 1/2	G 3/8	60	258	19	G 3/8	19	175	10	80

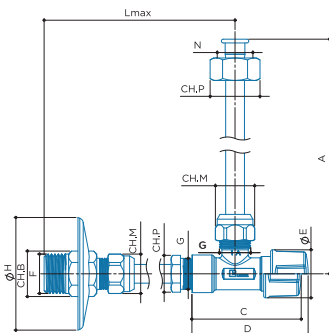

S 63

Rubinetto per cassetta di scarico con rosetta scorrevole, tubetti in rame cromati da 20 cm e cartuccia a 3 pezzi.

CODICE	MISURA	A	B	C	D	E	F	G	H	L	M	N	P			
70610025CC	MPR 1/2 - F 1/2	258	21	58,2	61,9	25,6	G 1/2	G 3/8	60	208	19	G 1/2	23	257	10	80
70611025CC	MPR 1/2 - F 3/8	258	21	58,2	61,9	25,6	G 1/2	G 3/8	60	208	19	G 3/8	19	255	10	60

DIAGRAMMA DI PORTATA

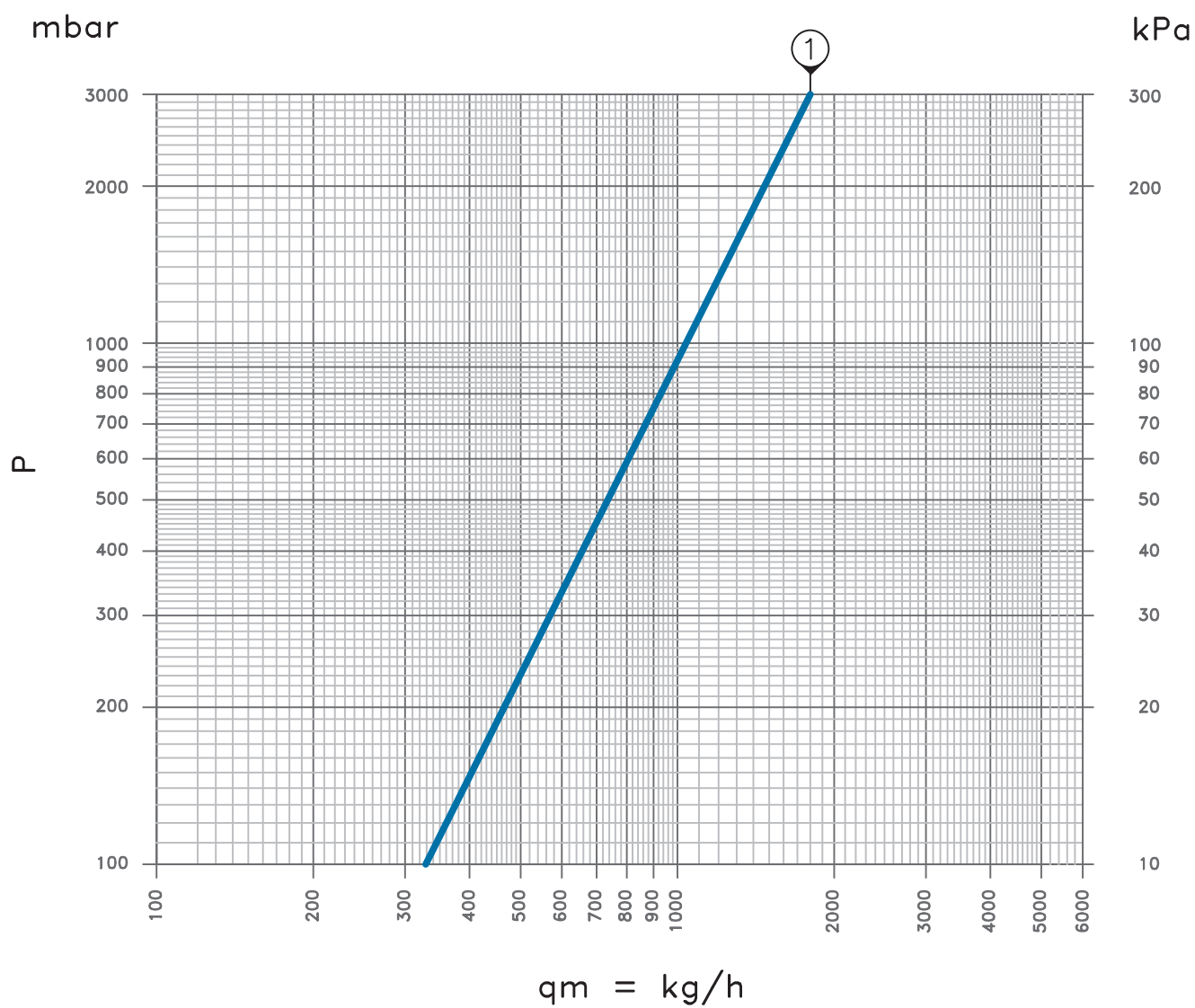

ARTICOLI	CODICE	Kv
S 60	70600100	1,10
S 61	70600020CC	
S 62	70601030CC	
S 63	70610025CC	
	70611025CC	



LUXOR®

RUBINETTI

6.6 / SERIE K

SERIE K

RUBINETTI PER ELETTRODOMESTICI



La gamma dei rubinetti multiuso comprende una varietà di articoli utilizzabili per i più disparati impieghi.

Gli articoli comprendono rubinetti a vitone, a sfera, a più derivazioni, per collegamento lavatrice, lavastoviglie e sottolavabo.

CARATTERISTICHE TECNICHE



Max temperatura

90 °C



Max pressione

10 bar



Materiale

CW617N



Manopola

ABS

CAMPI DI APPLICAZIONE



lavastoviglie



lavatrici



lavabi

MANIGLIA

La maniglia è realizzata in ABS con finitura cromata e possiede elevate proprietà meccaniche che gli permettono di resistere alle sollecitazioni di trazione, torsione e urto a cui potrebbe essere sottoposto il rubinetto durante il suo normale utilizzo.

ROSETTE

Le rosette sono realizzate in acciaio inox AISI 430 resistente all'azione degli agenti atmosferici, alle soluzioni alcaline degli acidi organici e all'ossidazione fino ad alte temperature.

LA GAMMA

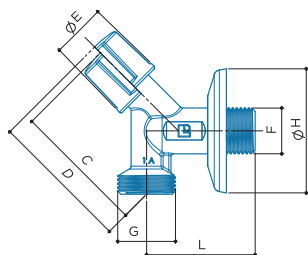

S 70

Rubinetto per lavatrice a vitone con rosetta scorrevole e maniglia inclinato a 45°. Senza valvola di ritorno.

CODICE	MISURA	A	B	C	D	E	F	G	H	L	M			
70352105	G 1/2 - G 3/4	-	-	60	65	25,6	G1/2	G3/4	56	49	-	142	10	100

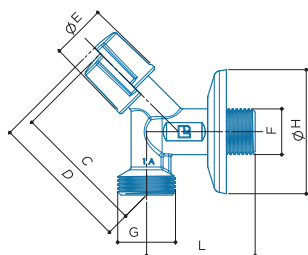

S 71

Rubinetto per lavatrice a vitone con rosetta scorrevole e maniglia inclinato a 45° con valvola di non ritorno per evitare il riflusso delle acque inquinate nella rete idrica.

CODICE	MISURA	A	B	C	D	E	F	G	H	L	M			
70352102	G 1/2 - G 3/4	-	-	60	65	25,6	G1/2	G3/4	56	49	-	144	10	100

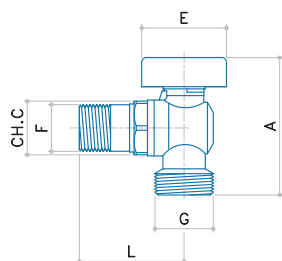

S 72

Rubinetto per lavatrice a sfera con maniglia a farfalla.

CODICE	MISURA	A	B	C	D	E	F	G	H	L	M			
70292127	G 1/2 - G 3/4	62	-	22	-	38	G1/2	G3/4	-	47	-	144	10	100

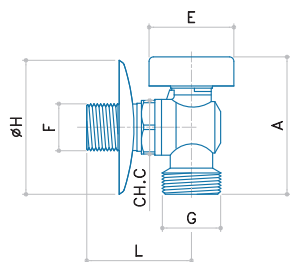

S 73

Rubinetto per lavatrice a sfera con maniglia a farfalla e rosetta scorrevole.

CODICE	MISURA	A	B	C	D	E	F	G	H	L	M			
70302127	G 1/2 - G 3/4	62	-	22	-	38	G1/2	G3/4	56	47	-	152	10	100

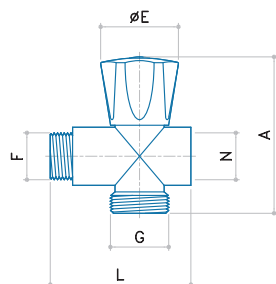

S 74

Rubinetto intermedio a vitone con attacco per lavatrice e maniglia a 6 punte.

CODICE	MISURA	A	E	F	G	L	N			
70312100	G 1/2 - G 1/2 (intermedio) G 3/4 (attacco lavatrice)	70	35	G1/2	G3/4	63	G1/2	174	10	100

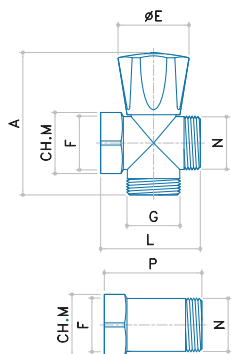

**S 75**

Rubinetto intermedio a vitone con attacco per lavatrice, maniglia a 6 punte e distanziatore.

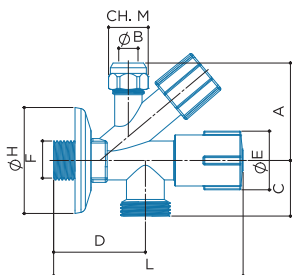
CODICE	MISURA	A	B	E	F	G	H	L	M	N	P			
70370000	G 3/4	70	-	35	G3/4	G3/4	-	49	30	G3/4	48	230	10	-

**S 76**

Rubinetto doppia uscita a vitone con attacco per lavatrice, rosetta scorrevole e cartuccia a 3 pezzi.

CODICE	MISURA	A	B	C	D	E	F	G	H	L	M			
70402101CC	G 3/4 - G 3/8 - G 1/2	53	10	28	49	31	G1/2	G3/4	56	100	19	236	5	50

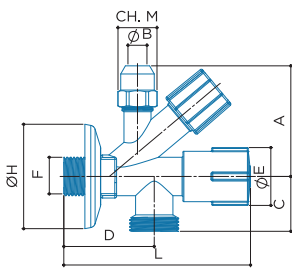

**S 77**

Rubinetto doppia uscita a vitone con attacco per lavatrice, rosetta scorrevole e cartuccia a 3 pezzi dado alto.

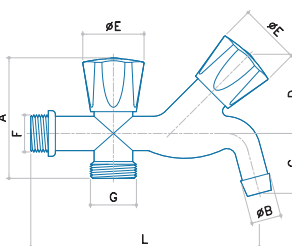
CODICE	MISURA	A	B	C	D	E	F	G	H	L	M			
70402102CC	G 3/4 - G 3/8 - G 1/2	61	10	28	49	31	G1/2	G3/4	56	100	19	244	5	50

**S 78**

Rubinetto doppia uscita a vitone con attacco per lavatrice.

CODICE	MISURA	A	B	C	D	E	F	G	H	L	M			
70162100	G 1/2 - G 3/4	69	17	34	45	35	G1/2	G3/4	-	130	-	376	6	-

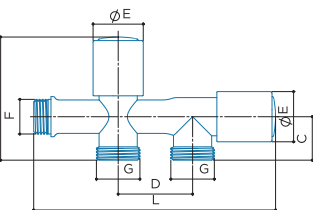
**S 79**

Rubinetto doppia uscita a vitone con attacco per lavatrice e lavastoviglie.

CODICE	MISURA	A	B	C	D	E	F	G	H	L	M			
70382100	G 1/2 - G 3/4 - G 3/4	74	-	26	45	30	G1/2	G3/4	-	144	-	296	6	-

CARTUCCIA RCC

La cartuccia RCC è la soluzione più sicura e funzionale per la connessione dei rubinetti alle utenze finali. Essendo i tre componenti raccolti in un corpo unico, la cartuccia RCC è la soluzione definitiva ai problemi di installazione dei raccordi a compressione. Non più componenti persi o montati in modo erraneo, ma un solo pezzo che garantisce un'ottima tenuta meccanica e idraulica allo stesso tempo.

La cartuccia è composta da una rondella a stringere in ottone ricotto CW614N con ottime caratteristiche meccaniche di malleabilità, da una guarnizione NBR e da una capsula conte-

nitiva in Nylon a grande tenacità ed elevata resistenza all'urto. Il filtro anticalcare è realizzato in acciaio inox AISI 304 resistente all'azione degli agenti atmosferici e all'ossidazione.

L'apposito tappo di ispezione è dotato di un comodo intaglio per facilitare le operazioni di apertura/chiusura e per semplificare l'operazione di pulizia del filtro. La maniglia ergonomica è realizzata in ABS con finitura cromata e possiede elevate proprietà meccaniche che gli permettono di resistere alle sollecitazioni di trazione, torsione e urto a cui potrebbe essere sottoposto il rubinetto durante il suo normale utilizzo.



1. Rondella a stringere in ottone CW614N

La rondella in ottone possiede ottime caratteristiche meccaniche grazie al processo di ricottura che migliora la malleabilità del materiale garantendo il corretto accoppiamento tra raccordo e tubo senza esercitare un'eccessiva forza di serraggio.

2. Guarnizione interna in NBR

Campo di utilizzo per temperature fino a 90°C:

le guarnizioni in NBR possiedono buone proprietà meccaniche, bassa deformazione permanente e bassa permeabilità al gas.

3. Cartuccia esterna in Nylon (Poliamide 6.6)

Campo di utilizzo per temperature fino a 90°C:

la cartuccia in Nylon possiede ottime caratteristiche di resistenza meccanica accoppiate a grande tenacità ed elevata resistenza all'urto.

DIAGRAMMA DI PORTATA

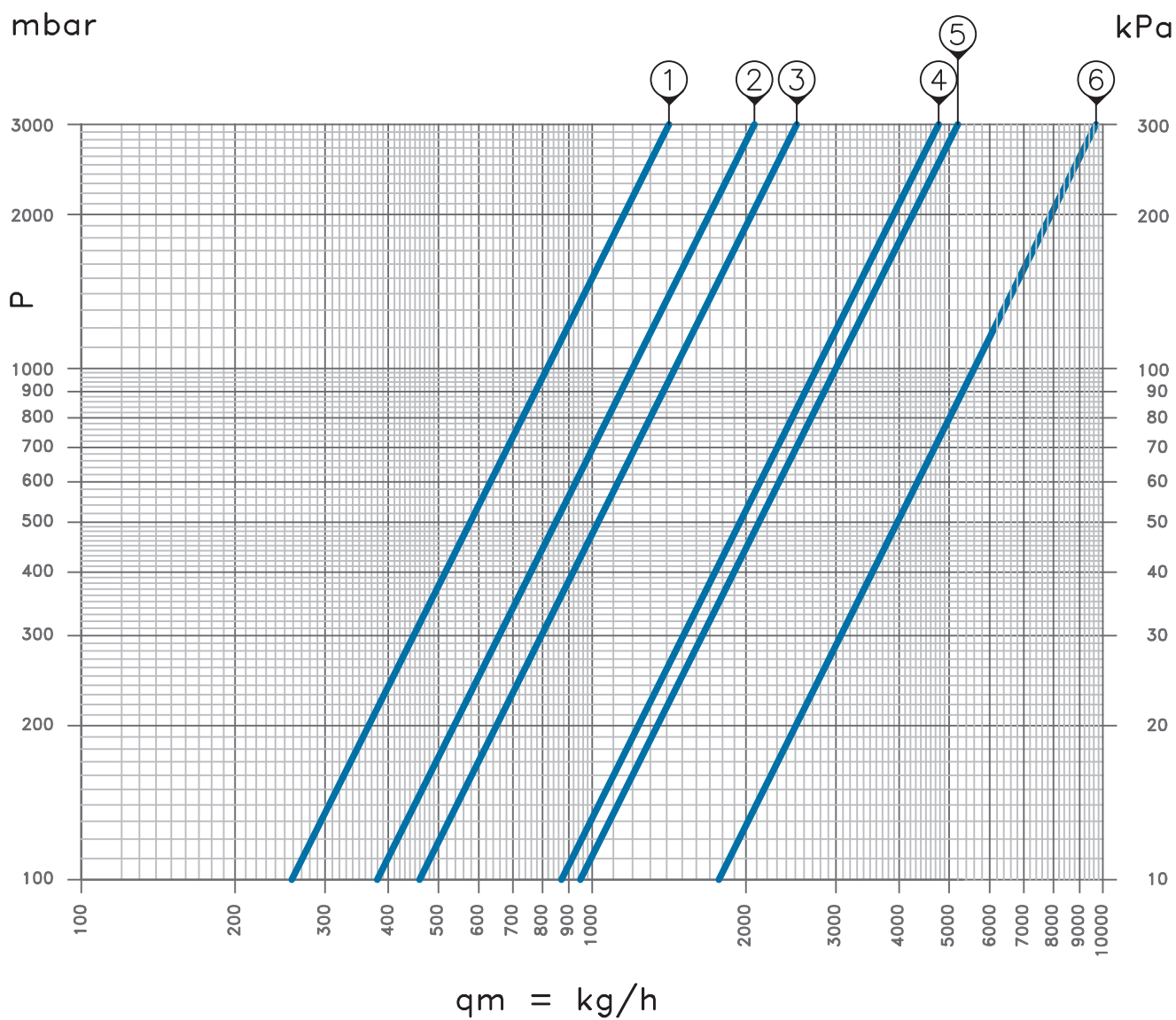

ARTICOLI	CODICE	CURVA	Kv
S 70	70352105	1	0,85
S 71	70352102		
S 76	70402101CC	2	1,20
S 77	70402102CC		
S 72	70292127	3	1,55
S 73	70302127		
S 74	70312100	4	2,75
S 79	70382100		
S 78	70162100	5	3,00
S 75	70370000	6	5,60



LUXOR®

RUBINETTI

6.7 / SERIE G

LA GAMMA

**G 80**

Rubinetto a galleggiante asta tonda in ottone serie pesante, 5 coppie.

CODICE	MISURA			
65041700	G 3/8	146	10	-
65042100	G 1/2	168	10	-



**G 81**

Rubinetto a galleggiante asta piatta in ottone serie pesante, 5 coppie.

CODICE	MISURA			
65012700	G 3/4	271	1	50
65013400	G 1"	410	1	50
65074200	G 1"1/4	1058	-	10
65074800	G 1"1/2	1385	-	10
65076000	G 2"	1872	-	5

**G 82**

Rubinetto a galleggiante in ottone silenzioso, regolabile con sede e tubo in plastica.

CODICE	MISURA			
65091700	G 3/8	154	10	-
65092100	G 1/2	182	10	-



**G 83**

Rubinetto a galleggiante in ottone con sede inox floating e tubo in plastica collaudato 9 bar.

CODICE	MISURA			
65131700	G 3/8	152	10	-
65132100	G 1/2	182	10	-

**G 84**

Rubinetto a galleggiante in ottone regolabile, per alta pressione (12 bar), con asta piatta e tubo in plastica.

CODICE	MISURA			
65122700	G 3/4	926	-	30
65123400	G 1"	980	-	30
65124200	G 1"1/4	1834	-	10
65124800	G 1"1/2	1880	-	10
65126000	G 2"	3030	-	5



SFERA PIATTA



Sfera in plastica con filetto per attacco asta tonda.

CODICE	MISURA			
65150000	-	34	10	50



SFERA TONDA

Sfera in plastica con attacco scorrevole per asta piatta.

CODICE	MISURA			
65160001	Ø 120	82	5	20
65160002	Ø 180	214	1	10



LUXOR®

RUBINETTI

6.8 / ACCESSORI

ACCESSORI

**SNODO E DADO BASSO**

Snodo 3/8 con dado basso.

CODICE	MISURA			
05210000CC	G 1/2 - G 3/8 Ø 10	56	30	-



**SNODO E DADO ALTO**

Snodo 3/8 con dado alto.

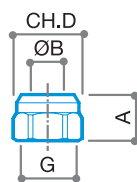
CODICE	MISURA			
05220000CC	G 1/2 - G 3/8 Ø 10	62	30	-



**DADO**

Dado in ottone cromato per raccordi a compressione.

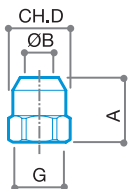
CODICE	RACCORDI	A	B	C	D	E	F	G	H	L			
76171000CF	3/8 - Ø 10	14	10	-	19	-	-	G 3/8	-	-	12	50	-
76171200CF	3/8 - Ø 12	14	12	-	19	-	-	G 3/8	-	-	12	50	-
76211000CF	1/2 - Ø 10	15	10	-	23	-	-	G 1/2	-	-	23	50	-
76211200CF	1/2 - Ø 12	15	12	-	23	-	-	G 1/2	-	-	21	50	-
76211400CF	1/2 - Ø 14	15	14	-	23	-	-	G 1/2	-	-	19	50	-



**DADO ALTO**

Dado alto in ottone cromato per raccordi a compressione.

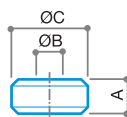
CODICE	RACCORDI	A	B	C	D	E	F	G	H	L			
76171001CF	3/8 - Ø 10	22	10	-	19	-	-	G 3/8	-	-	18	50	-

**OGIVA IN TEFLON**

Guarnizione di tenuta per raccordi a compressione.

CODICE	RACCORDI	A	B	C	D	E	F	G	H	L			
77171000CF	3/8 - Ø 10	6,5	10	14,5	-	-	-	-	-	-	1	100	-
77171200CF	3/8 - Ø 12	7	12	14,5	-	-	-	-	-	-	2	100	-
77211000CF	1/2 - Ø 10	7,5	10	18,5	-	-	-	-	-	-	1	100	-
77211200CF	1/2 - Ø 12	7,5	12	18,5	-	-	-	-	-	-	2	100	-
77211400CF	1/2 - Ø 14	7,5	14	18,5	-	-	-	-	-	-	2	100	-

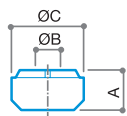

**CARTUCCIA 3 PEZZI BASSA**

Guarnizione di tenuta per raccordi a compressione.

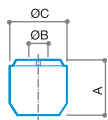
CODICE	RACCORDI	A	B	C	D	E	F	G	H	L			
77171002CF	3/8 - Ø 10	8	10	14,5	-	-	-	-	-	-	1	100	-



**CARTUCCIA 3 PEZZI ALTA**

Guarnizione di tenuta per raccordi a compressione dado alto.

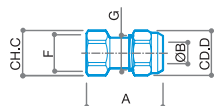
CODICE	RACCORDI	A	B	C	D	E	F	G	H	L			
77171003CF	3/8 - Ø 10	14	10	14,5	-	-	-	-	-	-	2	100	-



**PROLUNGA CROMATA**

Prolunga in ottone femmina-raccordo a compressione con cartuccia a 3 pezzi.

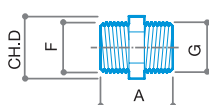
CODICE	RACCORDI	A	B	C	D	E	F	G	H	L			
05160000CC	F 3/8 - RCC 3/8	40	10	19	19	-	G 3/8	G 3/8	-	-	40	30	-



**RACCORDO NIPPOLO CROMATO**

Raccordo in ottone Maschio-Maschio.

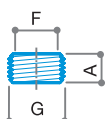
CODICE	RACCORDI	A	B	C	D	E	F	G	H	L			
55021700	M 3/8 x M 3/8	31	-	-	17	-	G 3/8	G 3/8	-	-	31	25	-
55022100	M 1/2 x M 1/2	28	-	-	21	-	G 1/2	G 1/2	-	-	36	25	-



**RIDUZIONE**

Riduzione in ottone Maschio-Femmina.

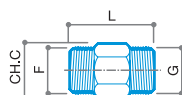
CODICE	RACCORDI	A	B	C	D	E	F	G	H	L			
55051700	M 1/2 x F 3/8	10	-	-	-	-	G 3/8	G 1/2	-	-	4	100	-
55052100	M 3/4 x F 1/2	11	-	-	-	-	G 1/2	G 3/4	-	-	14	100	-

**RACCORDO NIPPOLO PROLUNGATO CROMATO**

Raccordo in ottone Maschio-Maschio.

CODICE	RACCORDI	A	B	C	D	E	F	G	H	L			
05331721	MP 1/2 x M 3/8	-	-	17	-	-	G 1/2	G 3/8	-	38	50	25	-
05332121	MP 1/2 x M 1/2	-	-	21	-	-	G 1/2	G 1/2	-	38	52	25	-

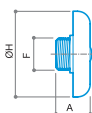

**TAPPO CON ROSETTA**

Tappo in ottone con rosetta ø 55 mm di copertura e vite di fissaggio.

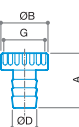
CODICE	RACCORDI	A	B	C	D	E	F	G	H	L			
55072100	M 1/2	23	-	-	-	-	G 1/2	-	55	-	55	20	200

**GIRELLO**

Ghiera girello con portagomma in ottone nichelato.

CODICE	RACCORDI	A	B	C	D	E	F	G	H	L			
55271500	F 3/4	33	28	-	15	-	-	G 3/4	-	-	24	25	-
55342000	F 1"	40	35	-	20	-	-	G 1"	-	-	38	20	-

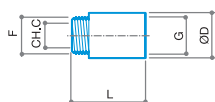

**PROLUNGA CROMATA M-F**

Prolunga in ottone lucido cromato Maschio-Femmina.

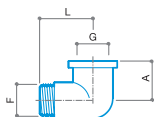
CODICE	RACCORDI	A	B	C	D	E	F	G	H	L			
55062110	M 1/2 - F 1/2	-	-	13	24	-	G 1/2	G 1/2	-	20	26	50	-
55062115	M 1/2 - F 1/2	-	-	13	24	-	G 1/2	G 1/2	-	25	32	50	-
55062120	M 1/2 - F 1/2	-	-	13	24	-	G 1/2	G 1/2	-	30	38	50	-
55062125	M 1/2 - F 1/2	-	-	13	24	-	G 1/2	G 1/2	-	35	46	25	-
55062130	M 1/2 - F 1/2	-	-	13	24	-	G 1/2	G 1/2	-	40	52	25	-
55062140	M 1/2 - F 1/2	-	-	13	24	-	G 1/2	G 1/2	-	50	68	25	-
55062150	M 1/2 - F 1/2	-	-	13	24	-	G 1/2	G 1/2	-	60	82	25	-



**CURVA 90° CROMATA M-F**

Curva in ottone lucida cromata Maschio-Femmina.

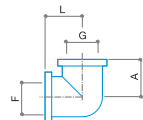
CODICE	RACCORDI	A	B	C	D	E	F	G	H	L			
55131700	M 3/8 - F 3/8	24	-	-	-	-	G 3/8	G 3/8	-	30	58	25	-
55132100	M 1/2 - F 1/2	24	-	-	-	-	G 1/2	G 1/2	-	33	68	25	-
55132700	M 3/4 - F 3/4	30	-	-	-	-	G 3/4	G 3/4	-	41	132	10	-
55133400	M 1" - F 1"	39	-	-	-	-	G 1"	G 1"	-	51	268	10	-



**CURVA 90° CROMATA F-F**

Curva in ottone lucida cromata Femmina-Femmina.

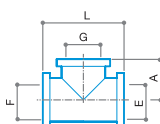
CODICE	RACCORDI	A	B	C	D	E	F	G	H	L			
55151700	F 3/8 - F 3/8	23	-	-	-	-	G 3/8	G 3/8	-	23	48	25	-
55152100	F 1/2 - F 1/2	24	-	-	-	-	G 1/2	G 1/2	-	24	68	25	-
55152700	F 3/4 - F 3/4	24	-	-	-	-	G 3/4	G 3/4	-	24	112	10	-
55153400	F 1" - F 1"	35	-	-	-	-	G 1"	G 1"	-	35	168	10	-



**RACCORDO A T CROMATO**

Raccordo di derivazione a 3 vie in ottone cromato.

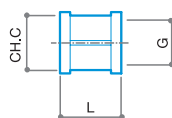
CODICE	RACCORDI	A	B	C	D	E	F	G	H	L			
55171700	F 3/8	24	-	-	-	G 3/8	G 3/8	G 3/8	-	48	102	25	-
55172100	F 1/2	24	-	-	-	G 1/2	G 1/2	G 1/2	-	47	98	25	-
55172700	F 3/4	25	-	-	-	G 3/4	G 3/4	G 3/4	-	49	108	10	-
55173400	F 1"	35	-	-	-	G 1"	G 1"	G 1"	-	67	264	10	-

**MANICOTTO CROMATO F-F**

Raccordo in ottone lucido cromato Femmina-Femmina.

CODICE	RACCORDI	A	B	C	D	E	F	G	H	L			
55191700	F 3/8-F 3/8	-	-	-	-	-	-	G 3/8	-	31	40	25	-
55192100	F 1/2-F 1/2	-	-	24	-	-	-	G 1/2	-	27	44	25	-
55192700	F 3/4-F 3/4	-	-	30	-	-	-	G 3/4	-	33	66	10	-
55193400	F 1"-F 1"	-	-	37	-	-	-	G 1"	-	250	90	10	-

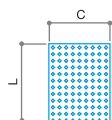
**FILTRO INOX**

Filtro in acciaio inox per rubinetti a sfera sottolavabo Luxor.

CODICE	RACCORDI	A	B	C	D	E	F	G	H	L			
2903015CF	Ø 13,8	-	-	13,8	-	-	-	-	-	17,5	0,4	50	-



LUXOR®

7 / SIFONI

SIFONI



CARATTERISTICHE COSTRUTTIVE

I sifoni Luxor Spa offrono la qualità e l'affidabilità del prodotto Made in Italy. La gamma di articoli, apprezzata dagli installatori per la loro solidità e durata nel tempo, comprende i tipi di sifone comunemente utilizzati per convogliare l'acqua di scarico di lavabo, bidet e lavatrice.

Alcuni tra gli articoli proposti sono conformi a quanto previsto dalla norma UNI EN274 ed in particolare soddisfano il requisito dimensionale relativo alla colonna d'acqua che non deve essere inferiore ai 50 mm.

FINITURA CROMATA

Tutta la gamma viene prodotta con finitura cromata a telaio che garantisce maggiori spessori di ricopertura e di conseguenza una maggiore resistenza all'invecchiamento e alla corrosione, nonché una finitura estetica di livello superiore.

Tale cromatura viene realizzata utilizzando sostanze e processi galvanici conformi alle più rigide normative internazionali in materia di sanità e di sicurezza ambientale.

I corpi dei sifoni vengono realizzati utilizzando ottone CW617N a basso contenuto di piombo in conformità alla norma UNI EN12165 che ne regola la composizione chimica.

I sifoni realizzati da tubo vengono invece prodotti utilizzando ottone CW508L conforme alla norma UNI EN12449. Nella gamma di prodotti sono presenti inoltre sifoni in ABS cromato con ottima durezza superficiale, resistenza chimica agli agenti esterni e resistenza agli urti.

Le rosette, lucidate e cromate, sono realizzate sia in acciaio inox AISI 430 che in ottone e sono in grado di resistere all'azione degli agenti atmosferici e all'ossidazione che si potrebbe formare durante il normale utilizzo.





LUXOR®

SIFONI

7.1 / SERIE ST

SERIE ST

SIFONI STANDARD



I sifoni Luxor Spa offrono la qualità e l'affidabilità del prodotto Made in Italy.

La gamma di articoli, apprezzata dagli installatori per la loro solidità e durata nel tempo, comprende i tipi di sifone comunemente utilizzati per convogliare l'acqua di scarico di lavabo e bidet.

CARATTERISTICHE TECNICHE



Materiale corpo sifone

CW 617 N - DW UNI-EN 12165:2016



Materiale rosone

AISI 430



Materiale codolo e canotto

CW 508L



Finitura

Cromata

CAMPI DI APPLICAZIONE



lavabi

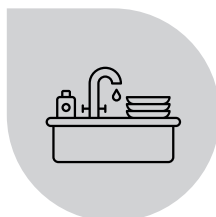



lavabo cucina

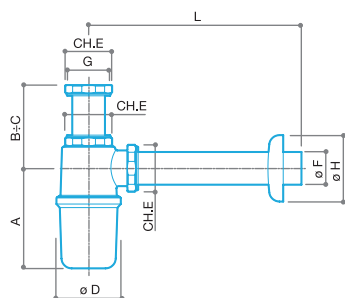

bidet

**SIF 001**



Sifone bottiglia in ottone cromato senza piletta, ispezionabile, con rosone in acciaio inox.

CODICE	MISURA	Ø TUBO x L mm	A	B	C	D	E	F	G	H	L			
93323401	G 1"	26 x 200	80	35	105	55	36	26	G 1"	75	223	434	10	40
93323403		26 x 250	80	35	105	55	36	26	G 1"	75	273	442	10	40
93323404		26 x 250	80	75	145	55	36	26	G 1"	75	273	450	10	40

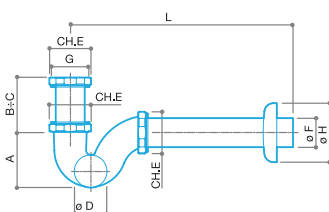
93324201	G 1"1/4	32 x 200	98	35	105	64	44	32	G 1"1/4	75	223	496	10	40
93324203		32 x 250	98	35	105	64	44	32	G 1"1/4	75	273	504	10	40
93324204		32 x 250	98	75	145	64	44	32	G 1"1/4	75	273	512	10	40

**SIF 002**



Sifone "S" per bidet in ottone cromato senza piletta, ispezionabile, con rosone in acciaio inox.

CODICE	MISURA	Ø TUBO x L mm	A	B	C	D	E	F	G	H	L			
93363401	G 1"	26 x 200	50	85	95	30	36	26	G 1"	75	265	356	10	40
93363403		26 x 250	50	85	95	30	36	26	G 1"	75	315	364	10	40
93363404		26 x 250	50	125	135	30	36	26	G 1"	75	315	372	10	40

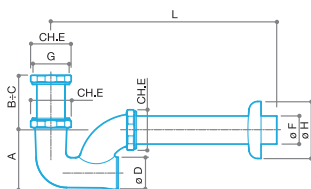
93364201	G 1"1/4	32 x 200	60	70	85	36	44	32	G 1"1/4	75	265	452	10	40
93364203		32 x 250	60	70	85	36	44	32	G 1"1/4	75	315	460	10	40
93364204		32 x 250	60	110	125	36	44	32	G 1"1/4	75	315	468	10	40

**SIF 003**

Sifone colonna per lavabo in ottone cromato senza piletta, ispezionabile, con rosone in acciaio inox.



CODICE	MISURA	Ø TUBO x L mm	A	B	C	D	E	F	G	H	L			
93403401	G 1"	26 x 200	65	80	90	32	36	26	G 1"	75	282	384	10	40
93403403		26 x 250	65	80	90	32	36	26	G 1"	75	332	392	10	40
93403404		26 x 250	65	120	130	32	36	26	G 1"	75	332	400	10	40

93404201	G 1"1/4	32 x 200	67	80	90	36	44	32	G 1"1/4	75	276	458	10	40
93404203		32 x 250	67	80	90	36	44	32	G 1"1/4	75	326	466	10	40
93404204		32 x 250	67	120	130	36	44	32	G 1"1/4	75	326	474	10	40

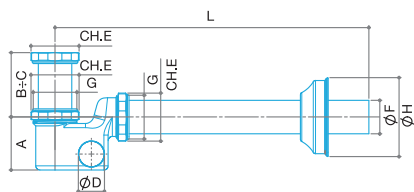
* codolo 120 mm

**SIF 004**

Sifone compatto in ottone cromato senza piletta, ispezionabile, con rosone in acciaio inox.

CODICE	MISURA	Ø TUBO x L mm	A	B	C	D	E	F	G	H	L			
93444203	G 1"1/4	32 x 250	51	30	50	25	44	32	G 1"1/4	75	300	571	10	40

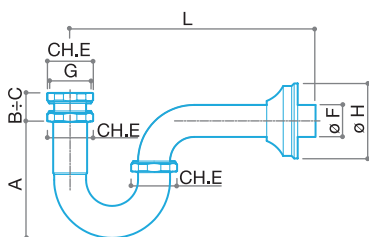

**SIF 017**

Sifone per lavabo in tubo di ottone cromato senza piletta, con rosone in ottone cromato.

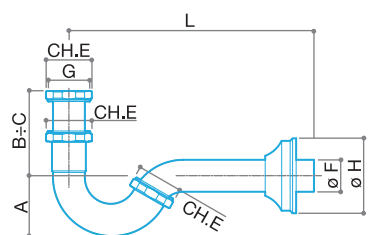
CODICE	MISURA	A	B	C	D	E	F	G	H	L			
93544200	G 1"1/4	118	28	65	-	44	32	G 1"1/4	75	317	400	10	40

**SIF 018**

Sifone per bidet in tubo di ottone cromato senza piletta, con rosone in ottone cromato.

CODICE	MISURA	A	B	C	D	E	F	G	H	L			
93524200	G 1"1/4	62	80	100	-	44	32	G 1"1/4	75	310	396	10	40



LUXOR®

SIFONI

7.2 / SERIE PREMIUM

SERIE PREMIUM

SIFONI DI LUSO



I sifoni Luxor Spa offrono la qualità e l'affidabilità del prodotto Made in Italy.

La gamma di articoli, apprezzata dagli installatori per la loro solidità e durata nel tempo, comprende i tipi di sifone comunemente utilizzati per convogliare l'acqua di scarico di lavabo e bidet.

CARATTERISTICHE TECNICHE



Materiale corpo sifone

CW 617 N - DW UNI-EN 12165:2016



Materiale rosone

CW 508L



Materiale codolo e canotto

CW 508L



Finitura

Cromata

CAMPI DI APPLICAZIONE



lavabi





lavabo cucina

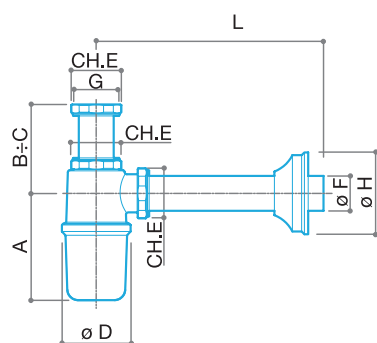

bidet

**SIF 005**

Sifone bottiglia lusso in ottone cromato senza piletta, ispezionabile, con rosone in ottone cromato.

CODICE	MISURA	Ø TUBO x L mm	A	B	C	D	E	F	G	H	L			
93023400	G 1"	26 x 250	80	35	105	55	36	26	G 1"	75	273	438	10	40
93023404		26 x 250	80	75	145	55	36	26	G 1"	75	273	446	10	40



*

93024200	G 1 1/4	32 x 250	98	35	105	64	44	32	G 1 1/4	75	273	572	10	40
93024204		32 x 250	98	75	145	64	44	32	G 1 1/4	75	273	578	10	40

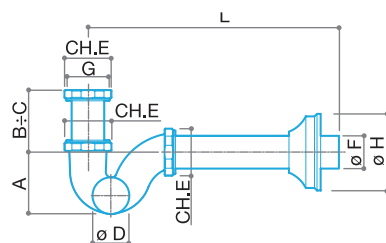
*

**SIF 006**

Sifone "S" lusso per bidet in ottone cromato senza piletta, ispezionabile, con rosone in ottone cromato.

CODICE	MISURA	Ø TUBO x L mm	A	B	C	D	E	F	G	H	L			
93163400	G 1"	26 x 250	50	85	95	30	36	26	G 1"	75	315	360	10	40
93163404		26 x 250	50	125	135	30	36	26	G 1"	75	315	368	10	40



*

93164200	G 1 1/4	32 x 250	60	70	85	36	44	32	G 1 1/4	75	315	454	10	40
93164204		32 x 250	60	110	125	36	44	32	G 1 1/4	75	315	462	10	40

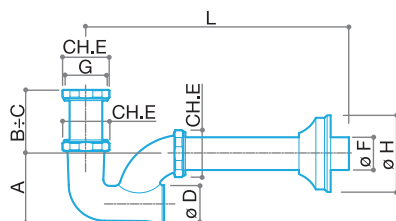
*

**SIF 007**

Sifone colonna lusso per lavabo in ottone cromato senza piletta, ispezionabile, con rosone in ottone cromato.

CODICE	MISURA	Ø TUBO x L mm	A	B	C	D	E	F	G	H	L			
93203400	G 1"	26 x 250	65	80	90	32	36	26	G 1"	75	332	388	10	40
93203404		26 x 250	65	120	130	32	36	26	G 1"	75	332	396	10	40

*

93204200	G 1 1/4	32 x 250	67	80	90	36	44	32	G 1 1/4	75	332	460	10	40
93204204		32 x 250	67	120	130	36	44	32	G 1 1/4	75	332	468	10	40

*

* codolo 120 mm



LUXOR®

SIFONI

7.3 / SERIE PL

SERIE PL

SIFONI IN ABS



I sifoni Luxor Spa offrono la qualità e l'affidabilità del prodotto Made in Italy.

La gamma di articoli, apprezzata dagli installatori per la loro solidità e durata nel tempo, comprende i tipi di sifone comunemente utilizzati per convogliare l'acqua di scarico di lavabo e bidet.

In ogni scatola dei sifoni in ABS è incluso un paio di guanti per una migliore cura e pulizia del sifone in fase di montaggio.

CARATTERISTICHE TECNICHE



Materiale corpo sifone
ABS Cromato



Materiale rosone
ABS Cromato



Materiale codolo e canotto
ABS Cromato



Finitura
Cromata

CAMPI DI APPLICAZIONE



lavabi





lavabo cucina

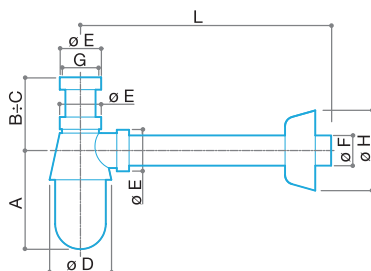

bidet



**SIF 008**

Sifone bottiglia in ABS cromato senza piletta, ispezionabile, con rosone in ABS cromato.

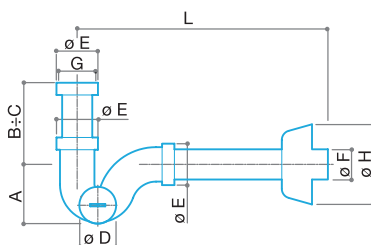
CODICE	MISURA	Ø TUBO x L mm	A	B	C	D	E	F	G	H	L			
96023400	G 1"	26 x 250	84	45	121	61	35	26	G 1"	85	287	202	1	10
* 96024200	G 1 1/4	32 x 250	105	48	128	66	44	32	G 1 1/4	85	293	272	1	10



**SIF 009**

Sifone "S" per bidet in ABS cromato senza piletta, ispezionabile, con rosone in ABS cromato.

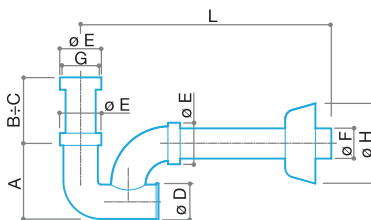
CODICE	MISURA	Ø TUBO x L mm	A	B	C	D	E	F	G	H	L			
96163400	G 1"	26 x 250	68	57	102	35	35	26	G 1"	85	342	188	1	10
96164200	G 1 1/4	32 x 250	63	87	132	39	44	32	G 1 1/4	85	342	228	1	10

**SIF 010**

Sifone colonna per lavabo in ABS cromato senza piletta, ispezionabile, con rosone in ABS cromato.

CODICE	MISURA	Ø TUBO x L mm	A	B	C	D	E	F	G	H	L			
96203400	G 1"	26 x 250	67	63	92	35	35	26	G 1"	85	345	174	1	10
96204200	G 1 1/4	32 x 250	80	70	110	39	44	32	G 1 1/4	85	350	236	1	10

* Sifone conforme a quanto richiesto dallo standard EN 274 con colonna d'acqua > 50 mm



LUXOR®

SIFONI

7.4 / SERIE 50th

SERIE 50th

SIFONI D'ARREDO



CARATTERISTICHE COSTRUTTIVE

I sifoni d'arredo Serie 50th sono dei prodotti d'eccellenza Made in Italy e si distinguono per il design, per le finiture superficiali altissimo livello e per le caratteristiche tecniche che li rendono conformi a quanto previsto dalla norma UNI EN274. In particolare soddisfano il requisito dimensionale relativo alla colonna d'acqua che non deve essere inferiore ai 50 mm.

CROMATURA A TELAIO

I sifoni vengono lucidati finemente a mano e la cromatura viene eseguita a telaio garantendo maggiori spessori di ricopertura e di conseguenza una maggiore resistenza all'invecchiamento e alla corrosione, nonché una finitura estetica di livello pregiato. Tale cromatura viene realizzata utilizzando sostanze e processi galvanici conformi alle più rigide normative internazionali in materia di sanità e di sicurezza ambientale.

CORPO

Il corpo del sifone viene realizzato utilizzando ottone CW617N a basso contenuto di piombo in conformità alla normativa Europea UNI EN12165 a garanzia di un prodotto igienicamente sicuro ed affidabile. Le ghiere di serraggio e il tappo d'ispezione sono in ottone CW614N a basso contenuto di piombo in conformità alla normativa Europea UNI EN12164 che ne stabilisce le caratteristiche di composizione chimica.

DOPPIA TENUTA O-RING

Caratteristica peculiare ed esclusiva dei sifoni d'arredo Prestige è la doppia tenuta o-ring in EPDM e il canotto sfilabile. Questo sistema consente di collegare il sifone alla piletta di scarico e permette agli installatori di tagliare comodamente in un secondo momento il canotto, senza rovinare il corpo del sifone ed evitando di scartare l'intero sifone per un errore di taglio del tubo di scarico. Questa soluzione tecnica fa del sifone d'arredo Luxor Spa un sicuro punto di riferimento per ogni tipo di esigenza estetica, funzionale e di installazione.

TAPPO DI ISPEZIONE

L'apposito tappo di ispezione in ottone è dotato di un comodo intaglio per facilitare le operazioni di apertura/chiusura e per semplificare la periodica pulizia del sifone. Non sono necessari particolari attrezzi di lavoro per eseguire l'ispezione del sifone, basta una semplice moneta.

ROSONE DI COPERTURA

Il rosone di copertura scarico è realizzato in ottone. E' resistente all'usura e alla corrosione del tempo e viene anch'esso lucidato e cromato a telaio con finitura di ottimo pregio.

CARATTERISTICHE TECNICHE



Materiale corpo sifone

CW 617 N - DW UNI-EN 12165:2016



Materiale rosone

CW 508L



Materiale codolo e canotto

CW 508L



Finitura

Cromata

CAMPI DI APPLICAZIONE



lavabi

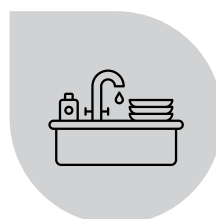

lavabo cucina

**SIF 011**

Sifone d'arredo classico in ottone con finitura cromata o nera, senza piletta, ispezionabile, con canotti, rosone e ghiera in ottone.

CODICE	MISURA	Ø TUBO x L mm	FINITURA	A	B	C	D	E	F	G	H	L			
** 93654200	G 1"1/4	32 x 320	CHROME	95	58	128	52	52	32	G 1"1/4	68	356	950	1	5
** 93654200N	G 1"1/4	32 x 320	BLACK	95	58	128	52	52	32	G 1"1/4	68	356	950	1	5

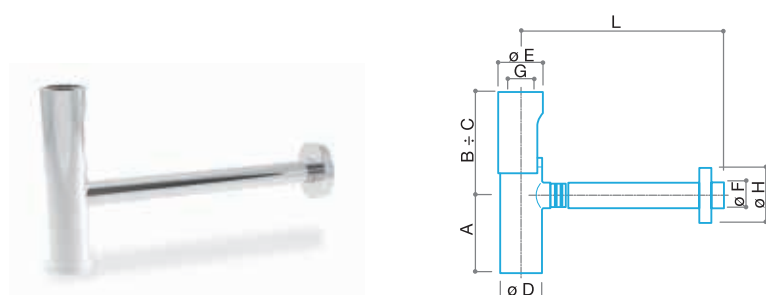
**SIF 012**

Sifone d'arredo a scomparsa in ottone cromato senza piletta, ispezionabile, con canotti, rosone, ghiera e guscio in ottone cromato.

CODICE	MISURA	Ø TUBO x L mm	A	B	C	D	E	F	G	H	L			
** 93664200	G 1"1/4	32 x 320	95	58	128	52	55	32	G 1"1/4	68	356	1.060	1	5

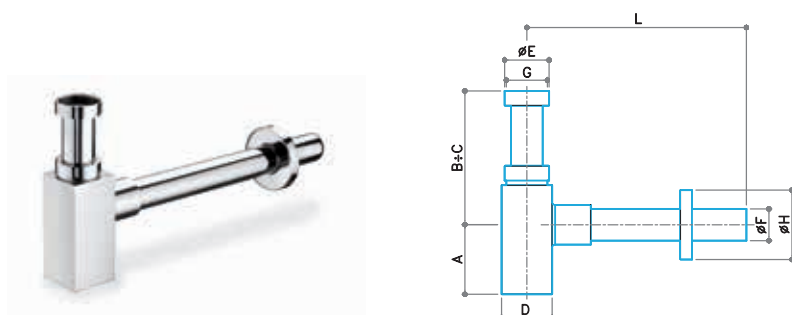
**SIF 013**

Sifone d'arredo quadrato in ottone cromato senza piletta, ispezionabile, con canotti, rosone e ghiera in ottone cromato.

CODICE	MISURA	Ø TUBO x L mm	A	B	C	D	E	F	G	H	L			
93634200	G 1" 1/4	32 x 300	70	80	180	50	44	32	G 1"1/4	70	325	890	1	5

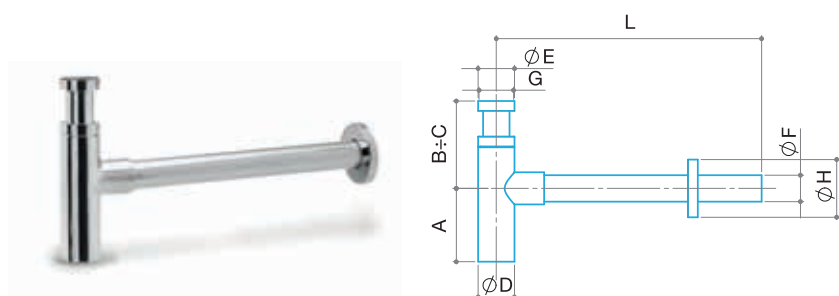
**SIF 014**

Sifone d'arredo tondo in ottone cromato senza piletta, ispezionabile, con canotti, rosone, ghiera in ottone cromato.

CODICE	MISURA	Ø TUBO x L mm	A	B	C	D	E	F	G	H	L			
93624200	G 1" 1/4	32 x 300	89	75	175	44	44	32	G 1"1/4	70	322	680	1	5

** Sifone conforme a quanto richiesto dallo standard EN 274 con colonna d'acqua > 50 mm



LUXOR®

SIFONI

7.5 / SERIE K

SERIE K

SIFONI PER ELETTRODOMESTICI



CAMPI DI APPLICAZIONE



lavatrici



lavastoviglie

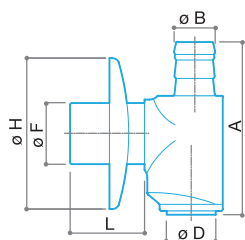

SIF 019

Sifone scarico elettrodomestici in ottone cromato da esterno, ispezionabile per scarico lavatrice e lavastoviglie.

CODICE	MISURA	A	B	C	D	E	F	G	H	L			
93733400	32 x 40	92	22	-	30	-	32	-	80	40	360	2	20

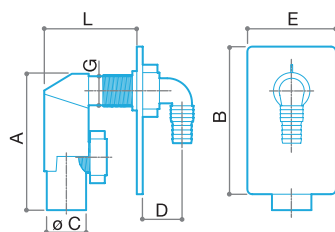

SIF 020

Sifone scarico elettrodomestici in plastica bianca da incasso, ispezionabile per scarico lavatrice e lavastoviglie.

CODICE	MISURA	A	B	C	D	E	F	G	H	L			
96264800	40	139	150	40	40	90	-	G 1"	-	94	176	1	50



LUXOR®

SIFONI

7.6 / TUBI DI SCARICO E ACCESSORI

TUBI DI SCARICO E ACCESSORI

**CARATTERISTICHE COSTRUTTIVE**

I tubi scarico sono realizzati in ottone CW508L a basso contenuto di piombo in conformità alla norma UNI EN12449.

GAMMA

La gamma è composta da tubi lisci, tubi con flangia, tubi curva, adattatori e prolunghe cromati a telaio per garantire una maggiore resistenza all'invecchiamento e alla corrosione.





Tale cromatura viene realizzata utilizzando sostanze e processi galvanici conformi alle più rigide normative internazionali in materia di sanità e di sicurezza ambientale.

ROSONI

I rosoni, lucidati e cromati, sono realizzati sia in acciaio inox AISI 430 che in ottone e sono in grado di resistere all'azione degli agenti atmosferici e all'ossidazione che si potrebbe formare durante il normale utilizzo.

**TUB 009**

Tubo di scarico in ottone cromato liscio.

CODICE	MISURA	A	B	C	D	E	F	G	H	L				
35012620	Ø 26	26	-	-	-	-	-	-	-	200	52	-	10	80
35012625		26	-	-	-	-	-	-	-	250	60	-	10	80
35012630		26	-	-	-	-	-	-	-	300	72	-	10	80
35012699		26	-	-	-	-	-	-	-	1000	248	5	-	-
35013020	Ø 30	30	-	-	-	-	-	-	-	200	56	-	10	80
35013025		30	-	-	-	-	-	-	-	250	68	-	10	80
35013030		30	-	-	-	-	-	-	-	300	86	-	10	80
35013099		30	-	-	-	-	-	-	-	1000	290	5	-	-
35013220	Ø 32	32	-	-	-	-	-	-	-	200	64	-	10	80
35013225		32	-	-	-	-	-	-	-	250	72	-	10	80
35013230		32	-	-	-	-	-	-	-	300	88	-	10	80
35013250		32	-	-	-	-	-	-	-	500	148	5	-	-
35013299		32	-	-	-	-	-	-	-	1000	300	5	-	-
35014020	Ø 40	40	-	-	-	-	-	-	-	200	80	-	5	-
35014025		40	-	-	-	-	-	-	-	250	116	-	5	-
35014030		40	-	-	-	-	-	-	-	300	134	-	5	-
35014099		40	-	-	-	-	-	-	-	1000	464	1	-	-

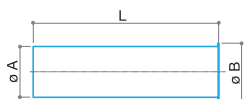
**TUB 010**

Tubo di scarico in ottone cromato con flangia ricavata.

CODICE	MISURA	A	B	C	D	E	F	G	H	L				
35022620	Ø 26	26	30	-	-	-	-	-	-	200	52	-	10	80
35022625		26	30	-	-	-	-	-	-	250	62	-	10	80
35022630		26	30	-	-	-	-	-	-	300	74	-	10	80

35023020	Ø 30	30	38	-	-	-	-	-	-	200	52	-	10	80
35023025		30	38	-	-	-	-	-	-	250	72	-	10	80
35023030		30	38	-	-	-	-	-	-	300	84	-	10	80

35023220	Ø 32	32	38	-	-	-	-	-	-	200	58	-	10	80
35023225		32	38	-	-	-	-	-	-	250	74	-	10	80
35023230		32	38	-	-	-	-	-	-	300	86	-	10	80

35024020	Ø 40	40	44	-	-	-	-	-	-	200	114	-	5	-
35024025		40	44	-	-	-	-	-	-	250	122	-	5	-
35024030		40	44	-	-	-	-	-	-	300	130	-	5	-

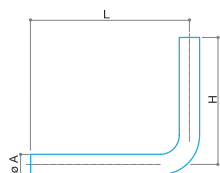
**TUB 011**

Tubo di scarico in ottone cromato con curva 90°.

CODICE	MISURA	A	B	C	D	E	F	G	H	L				
35050400	Ø 30	30	-	-	-	-	-	-	150	250	119	5	-	35
35050200		30	-	-	-	-	-	-	200	300	164	5	-	25

35050600	Ø 32	32	-	-	-	-	-	-	200	250	230	5	-	25
----------	------	----	---	---	---	---	---	---	-----	-----	-----	---	---	----

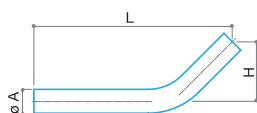

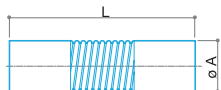

**TUB 012**

Tubo di scarico in ottone cromato con curva 45°.

CODICE	MISURA	A	B	C	D	E	F	G	H	L				
35060225	Ø 30	30	-	-	-	-	-	-	75	250	102	5	-	50



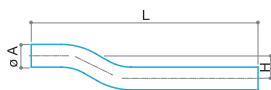

**TUB 013**

Tubo di scarico in ottone cromato pieghevole.

CODICE	MISURA	A	B	C	D	E	F	G	H	L				
35032625	Ø 26	26	-	-	-	-	-	-	-	250	66	-	10	-
35032630		26	-	-	-	-	-	-	-	300	86	-	10	-
35033025	Ø 30	30	-	-	-	-	-	-	-	250	86	-	10	-
35033030		30	-	-	-	-	-	-	-	300	102	-	10	-
35033225	Ø 32	32	-	-	-	-	-	-	-	250	94	-	10	-
35033230		32	-	-	-	-	-	-	-	300	99	-	10	-

**TUB 014**

Tubo di scarico in ottone cromato eccentrico.

CODICE	MISURA	A	B	C	D	E	F	G	H	L				
35152630	Ø 26	26	-	-	-	-	-	-	30	300	150	-	10	-
35153030	Ø 30	30	-	-	-	-	-	-	30	300	164	-	10	-
35153230	Ø 32	32	-	-	-	-	-	-	30	300	178	-	10	-

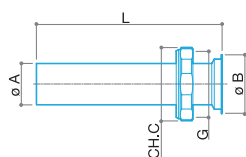



**TUB 015**

Tubo di scarico in ottone cromato con flangia ricavata e dado.

CODICE	MISURA	A	B	C	D	E	F	G	H	L				
35042620	Ø 26	26	37	44	-	-	-	G 1"1/4	-	200	86	-	10	-



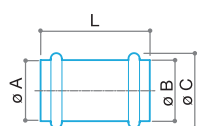

**TUB 016**

Prolunga in ottone cromata con o-ring.

CODICE	MISURA	A	B	C	D	E	F	G	H	L				
35160026	Ø 26	26	28	33	60	-	-	-	-	130	32	-	10	-
35160030	Ø 30	30	32	37	60	-	-	-	-	130	35	-	10	-
35160032	Ø 32	32	33	41	60	-	-	-	-	130	38	-	10	-
35160040	Ø 40	40	42	51	60	-	-	-	-	130	68	-	5	-



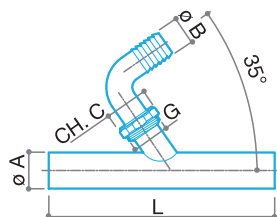

**TUB 017**

Giunto intermedio in ottone cromato con o-ring.

CODICE	MISURA	A	B	C	D	E	F	G	H	L				
35161026	Ø 26	26	28	33	-	-	-	-	-	55	22	-	10	-
35161030	Ø 30	30	32	37	-	-	-	-	-	55	28	-	10	-
35161032	Ø 32	32	33	41	-	-	-	-	-	60	34	-	10	-
35161040	Ø 40	40	42	51	-	-	-	-	-	70	53	-	5	-



**TUB 018**

Tubo di scarico in ottone cromato con curva in ABS cromata per scarico lavatrice e lavastoviglie.

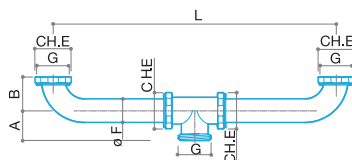
CODICE	MISURA	A	B	C	D	E	F	G	H	L				
35200026	Ø 26	26	25	36	-	-	-	G 1"	-	200	138	-	5	-
35200032	Ø 32	32	25	36	-	-	-	G 1"	-	200	142	-	5	-



**TUB 019**

Raccordo a due vie in ottone cromato senza piletta per sifoni.

CODICE	MISURA	A	B	C	D	E	F	G	H	L			
93504200	G 1"1/4	38	43	-	-	44	30	G 1"1/4	-	360	418	1	10



**DADI**

Dadi in ottone cromato per sifoni.

CODICE	MISURA	Ø TUBO mm			
97222600CF	G 1"	26	20	25	-
97223200CF	G 1"1/4	32	24	25	-



**RIDUZIONI**

Riduzioni in ottone cromato per adattare la piletta a sifoni di misura diversa.

CODICE	F	M			
94164200	G 1"1/4	G 1"	80	25	-
94164800	G 1"1/2	G 1"1/4	112	20	-



**GUARNIZIONE CONICA SIFONE**

Guarnizione conica in gomma nera.

CODICE	MISURA	Ø TUBO mm			
97172600CF	G 1"	26	1	100	-
97173000CF	G 1"1/4	30	1	100	-
97173200CF	G 1"1/4	32	1	100	-
97174000CF	G 1"1/2	40	1	100	-

**GUARNIZIONE CONICA SCARICO**

Guarnizione conica in gomma nera per adattare tubo di scarico.

CODICE	MISURA	Ø TUBO mm			
60294032CF	40 x 32 G 1"1/4 G 1"1/2	-	6	50	-

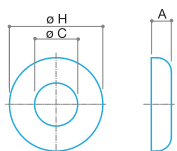
**ROS 101**

Rosone scorrevole in acciaio inox ϕ 65 mm con foro rotondo.

CODICE	MISURA	A	B	C	D	E	F	G	H	L				
30100026CF	ϕ 65	14	-	26	-	-	-	-	65	-	12	-	50	-
30100030CF		14	-	30	-	-	-	-	65	-	12	-	50	-
30100032CF		14	-	32	-	-	-	-	65	-	12	-	50	-

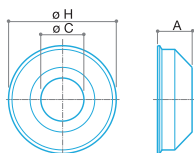
**ROS 102**

Rosone sagomato scorrevole in acciaio inox ϕ 75 mm con foro rotondo.

CODICE	MISURA	A	B	C	D	E	F	G	H	L				
30090126CF	ϕ 75	24	-	26	-	-	-	-	75	-	20	-	25	-
30090130CF		24	-	30	-	-	-	-	75	-	20	-	25	-
30090132CF		24	-	32	-	-	-	-	75	-	20	-	25	-

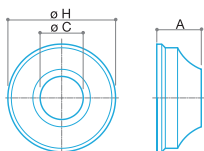

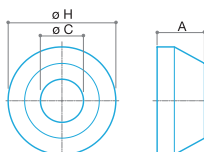

**ROS 103**

Rosone sagomato scorrevole in ottone cromato ϕ 75 mm con foro rotondo.

CODICE	MISURA	A	B	C	D	E	F	G	H	L				
30090026CF	ϕ 75	31	-	26	-	-	-	-	75	-	16	50	-	-
30090030CF		31	-	30	-	-	-	-	75	-	14	50	-	-
30090032CF		31	-	32	-	-	-	-	75	-	14	50	-	-



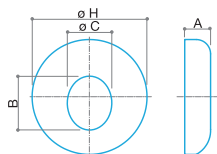

**ROS 104**

Rosone conico scorrevole in ottone cromato ϕ 75 mm con foro rotondo.

CODICE	MISURA	A	B	C	D	E	F	G	H	L				
30070026CF	ϕ 75	33	-	26	-	-	-	-	75	-	24	25	-	-
30070030CF		33	-	30	-	-	-	-	75	-	24	25	-	-
30070032CF		33	-	32	-	-	-	-	75	-	24	25	-	-
30070040CF		33	-	40	-	-	-	-	75	-	24	25	-	-

**ROS 105**

Rosone scorrevole in ottone cromato con foro ovale.

CODICE	MISURA	A	B	C	D	E	F	G	H	L				
30110030CF	ϕ 80	18	38	31	-	-	-	-	80	-	22	25	-	-
30110230CF	ϕ 110	31	38	31	-	-	-	-	110	-	64	5	-	-

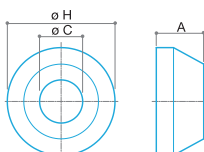

**ROS 106**

Rosone conico gigante scorrevole in ottone cromato ϕ 100 mm adatto per tubo eccentrico.

CODICE	MISURA	A	B	C	D	E	F	G	H	L				
35120026	ϕ 100	43	-	26	-	-	-	-	100	-	58	10	-	-
35120030		43	-	30	-	-	-	-	100	-	56	10	-	-
35120032		43	-	32	-	-	-	-	100	-	56	10	-	-



**MANICOTTO DIRITTO**

Manicotto in gomma bianca per braga w.c.

CODICE	MISURA	Ø TUBO mm			
60295000	Ø 100	-	179	1	-



**MANICOTTO ECCENTRICO**

Manicotto in gomma bianca per braga w.c.

CODICE	MISURA	Ø TUBO mm			
60295100	Ø 100	-	182	1	-



**MORSETTO UNIVERSALE**

Morsetto di riduzione in gomma per tubi di scarico.

CODICE	MISURA	Ø TUBO mm			
60291000	40	26-30-32	14	25	-
60291100	50	26-30-32	26	25	-
60291200	50	40	22	25	-



**MORSETTO STANDARD**

Morsetto di riduzione in gomma per tubi di scarico.

CODICE	MISURA	Ø TUBO mm			
60291300	47	26-30-32	22	25	-
60291400		40	12	25	-

**MORSETTO UNIVERSALE WC**

Morsetto di riduzione in gomma per w.c.

CODICE	MISURA	Ø TUBO mm			
60290200	50	30-32	28	50	-

**MORSETTO UNIVERSALE WC**

Morsetto di riduzione in gomma per w.c.

CODICE	MISURA	Ø TUBO mm			
60300000	60	30-32	34	50	-



LUXOR®

8 / ACCESSORI

ACCESSORI



CARATTERISTICHE COSTRUTTIVE

La gamma delle pilette Luxor Spa comprende una varietà di articoli utilizzabili per lo scarico di lavabo, vasche, piatti doccia, scarichi a pavimento, sistemi di drenaggio, ecc.

Le pilette sono realizzate in ottone CW617N a basso contenuto di piombo conforme alla normativa UNI EN12165 e in acciaio inox AISI 304 con ottime proprietà fisiche di resistenza all'ossidazione.

Per offrire una completa gamma di prodotti ai propri clienti Luxor Spa propone articoli di complemento ed accessori per i più comuni collegamenti sanitari.

I nipples sono realizzati in acciaio con trattamento superficiale di zincatura anticorrosione.

FINITURA CROMATA

I prodotti in ottone cromato CW617N e CW614N sono a basso contenuto di piombo in conformità alle più recenti normative UNI EN12165 e UNI EN12164. La loro finitura cromata garantisce esistenza alla invecchiamento e alla corrosione, nonché una finitura estetica di ottimo livello.

Tale cromatura viene realizzata utilizzando sostanze e processi galvanici conformi alle più rigide normative internazionali in materia di sanità e di sicurezza ambientale.

Le guarnizioni piane sono realizzate in EPDM perossidico e in Fasit, materiali atossici e idonei per l'adduzione di acqua potabile.





PILETTE



PIL 001



Piletta senza troppo pieno in ottone cromato con tappo, catena ed anello.

CODICE	MISURA	Ø TESTA x L mm			
94043401	G 1"	63 x 70	163	10	80
94044201	G 1"1/4	63 x 70	212	10	80



PIL 002



Piletta con troppo pieno in ottone cromato con tappo, catena, anello, senza codolo.

CODICE	MISURA	Ø TESTA x L mm			
94043400	G 1"	63 x 70	172	10	80
94044200	G 1"1/4	63 x 70	186	10	80



PIL 003



Piletta gattinara in ottone con griglia in acciaio inox, tappo, catena ed anello.

CODICE	MISURA	Ø TESTA mm			
94134200	G 1"1/4	80	202	10	80



PIL 004



Piletta gattinara in ottone con griglia in acciaio inox e tappo a maniglia.

CODICE	MISURA	Ø TESTA mm			
94134201	G 1"1/4	80	184	10	80



PIL 005



Piletta stop & go senza troppo pieno per lavabo automatica in ottone cromato.

CODICE	MISURA	Ø TESTA x L mm			
94084200	G 1"1/4	65 x 60	300	10	80



PIL 006



Piletta stop & go con troppo pieno per lavabo automatica in ottone cromato.

CODICE	MISURA	Ø TESTA x L mm			
94084201	G 1"1/4	65 x 60	305	10	80





PIL 007

Pilettone sifoide senza troppo pieno in ottone cromato per lavello in ceramica e vasca in cemento con tappo a maniglia, senza codolo.

CODICE	MISURA	Ø TESTA mm			
94234202	G 1"1/4	80	440	5	40



**PIL 008**

Piletton sifoide con troppo pieno in ottone cromato per lavello in ceramica e vasca in cemento con tappo a maniglia, senza codolo.

CODICE	MISURA	Ø TESTA mm			
94234201	G 1"1/4	80	440	5	40



**PIL 009**

Piletta doccia in ottone con griglia in acciaio inox, senza codolo.

CODICE	MISURA	Ø TESTA mm			
94314201	G 1"1/4	80	172	10	80
94314801	G 1"1/2	80	158	10	80



**PIL 010**

Piletta sifoide doccia in ottone con griglia in ottone cromato, senza codolo.

CODICE	MISURA	Ø TESTA mm			
94334201	G 1"1/4	75	304	5	40

**PIL 011**

Piletta sifoide doccia in ottone a pozzetto con flangia e griglia in ottone cromato.

CODICE	MISURA	Ø TESTA x H mm			
94368001	G 1"1/4	80 x 85	840	2	16

**PIL 012**

Pozzetto sifoide per pavimento in ottone cromato con scarico verticale filettato.

CODICE	MISURA	QUADRO mm			
95089999	G 1"1/4	100 x 100	626	2	-

**PIL 013**

Pozzetto sifoide per pavimento in ottone cromato con scarico laterale filettato.



CODICE	MISURA	QUADRO mm			
95069999	G 1"1/4	100 x 100	824	2	-

ACCESSORI



VITE CON ROSETTA



Vite con rosetta e triangolo per tappo con catena.

CODICE	MISURA	Ø ROSETTA mm			
60392000	-	40	18	25	-



TAPPI CON CATENA



Tappo in PVC nera con catena ed anello.

CODICE	MISURA	Ø TESTA mm			
60390031	Ø 31	-	14	25	-
60390040	Ø 40	-	24	25	-
60390052	Ø 52	-	27	25	-



TAPPI A MANIGLIA

Tappo in PVC nera a maniglia.

CODICE	MISURA	Ø TESTA mm			
60391052	Ø 52	-	22	25	-



GRIGLIA PIATTO DOCCIA



Griglia in ottone cromato per piletta sifoide doccia per cod. 94334201.

CODICE	MISURA	Ø GRIGLIA mm			
97184200	-	60	66	10	-



GRIGLIA PIATTO DOCCIA



Griglia in ottone cromato per pozzetto piatto doccia, per cod. 94368001.

CODICE	MISURA	Ø GRIGLIA mm			
97204200	-	45	38	10	-



GRIGLIA PER POZZETTO PAVIMENTO



Griglia in ottone cromato per pozzetto pavimento, per cod. 95089999 - 95069999.

CODICE	MISURA	Ø GRIGLIA mm			
97184201	-	90	164	2	-



GRIGLIA A CAMPANA



Griglia in acciaio inox per piletta sifoide.

CODICE	MISURA	Ø GRIGLIA mm			
97194200	-	45	34	10	-



COLONNA VASCA



Colonna automatica scarico vasca in ottone.

CODICE	MISURA	Ø GRIGLIA mm			
94484800	G 1"1/2	-	1030	1	20



CODOLO CURVO IN PEHD



Codoli curvi in PEHD con dado in ottone e guarnizione.

CODICE	MISURA	Ø TUBO mm			
94574201	G 1"1/4	40	82	10	-
94574801	G 1"1/2	40	100	10	-



CODOLO DIRITTO



Codoli diritti in ottone con dado e guarnizione.

CODICE	MISURA	Ø TUBO mm			
94583400	G 1"	26	46	10	-
94584200	G 1"1/4	32	62	10	-



CODOLO DIRITTO IN PEHD

Codoli diritti in PEHD con dado in ottone e guarnizione.

CODICE	MISURA	Ø TUBO mm			
94584201	G 1"1/4	40	72	10	-
94584801	G 1"1/2	40	84	10	-



NIPPLO SEDE PIANA-CONICA



Raccordo in acciaio zincato
Maschio-Maschio con sede piana
per collegamento antivibranti.
ARTICOLO IN ESAURIMENTO.

CODICE	MISURA			
27302100	G 1/2 x G 1/2	42	-	30
27306000	G 2" x G 2"	402	-	5



NIPPLO SEDE PIANA-PIANA

Raccordo in acciaio zincato
Maschio-Maschio.

CODICE	MISURA			
50081010CF	G 1/8 x G 1/8	10	10	100
50081013CF	G 1/8 x G 1/4	12	10	100
50081313CF	G 1/4 x G 1/4	12	10	50
50081317CF	G 1/4 x G 3/8	14	10	50
50081717CF	G 3/8 x G 3/8	20	10	50
50081721CF	G 3/8 x G 1/2	28	10	50
50081727CF	G 3/8 x G 3/4	52	10	50
50081734CF	G 3/8 x G 1"	74	10	50
50082121CF	G 1/2 x G 1/2	44	10	50
50082127CF	G 1/2 x G 3/4	58	10	50
50082134CF	G 1/2 x G 1"	76	10	50
50082727CF	G 3/4 x G 3/4	46	10	20
50082734CF	G 3/4 x G 1"	78	10	20
50083434CF	G 1" x G 1"	78	10	20



TAPPI COLLAUDO



Tappo per collaudo in plastica rossa o
blu per prova impianti.

CODICE	MISURA			
50112101CF-BLU	G 1/2	16	-	50
50112102CF-ROSSO		16	-	50



GUARNIZIONE IN FASIT

Guarnizione sanitarie in fasit.

CODICE	MISURA			
60171700CF	G 3/8	1	100	-
60172100CF	G 1/2	1	100	-
60172700CF	G 3/4	1	100	-
60173400CF	G 1"	1	100	-
60174200CF	G 1"1/4	1	100	-
60174800CF	G 1"1/2	1	100	-
60176000CF	G 2"	2	100	-

CONDIZIONI GENERALI DI VENDITA

1 PREMESSE - 1.1 Le presenti condizioni di vendita si applicano a tutte le forniture di Prodotti Luxor Spa (di seguito "Luxor"). Qualsiasi condizione generale, ed in particolare le condizioni di acquisto dell'Acquirente (di seguito "Cliente"), salvo espressa accettazione scritta da parte di Luxor, non vincoleranno quest'ultima né esimeranno il Cliente dall'applicazione delle presenti Condizioni Generali (di seguito CVG)

2 ORDINI - 2.1 Gli Ordini di Acquisto (di seguito "Ordini"), rappresentano un irrevocabile proposta d'acquisto, comportando per i clienti, l'automatica accettazione delle presenti Condizioni Generali di Vendita.

2.2 Gli Ordini non s'intendono accettati finché non siano stati confermati per iscritto da Luxor. L'emissione da parte di quest'ultima della conferma d'Ordine e/o della Fattura, sarà considerata quale conferma.

2.3 Eventuali modifiche dell'Ordine richieste dal Cliente successivamente all'invio della Conferma d'ordine, saranno valide ed esecutive, solo in seguito ad accettazione scritta di Luxor. La cancellazione o la modifica degli Ordini senza il preventivo consenso scritto di Luxor, daranno titolo a quest'ultima di agire per ottenere il rimborso dei costi sostenuti, fatto salvo il diritto al risarcimento del maggior danno.

3 PREZZI - 3.1 Il prezzo dei prodotti Luxor sarà fatturato in base al listino vigente al momento dell'accettazione dell'Ordine. Tutti i prezzi sono intesi IVA ed ulteriori eventuali imposte escluse.

3.2 I prezzi indicati nei cataloghi/listini di vendita hanno un carattere meramente indicativo e potranno subire variazioni in ragione dell'aumento dei costi di produzione. In questa eventualità, Luxor provvederà a comunicare gli aumenti dei prezzi alla parte acquirente indicandone le cause.

4 TERMINI DI CONSEGNA - 4.1 Le forniture oggetto di ogni singolo Ordine saranno consegnate entro i termini riportati in seno alla Conferma d'Ordine.

4.2 Nessuna responsabilità sarà ascrivibile alla Luxor, ove il ritardo nella consegna non sia a quest'ultima imputabile, come in caso di ritardi di terzi, inclusi fornitori e subfornitori, spedizionieri ed eventuali cause di forza maggiore che comportino l'inattività totale o parziale degli stabilimenti. Nei suddetti casi, la consegna della merce, anche se parziale, non può essere rifiutata dal Cliente e quest'ultimo non potrà avvalersi del ritardo nella consegna per risolvere il contratto e/o richiedere indennizzi a titolo di risarcimento danni.

5 SPEDIZIONI - 5.1 Fatti salvi eventuali diversi accordi, le consegne dei prodotti vengono effettuate in "Porto Assegnato" (Incoterms 2020 EXW), con spese e rischi connessi al trasporto posti a carico dell'acquirente.

5.2 Anche nel caso di consegna convenuta in "Porto Franco" (incoterms 2020 DDP) con spese a carico di Luxor, la merce viaggerà a rischio e pericolo dell'acquirente. Quali che siano i termini di resa pattuiti dalle Parti, i rischi passeranno all'Acquirente, al più tardi con la consegna al primo trasportatore.

5.3 Il trasferimento della proprietà dei beni è sospeso fino al completo pagamento del prezzo, senza che ciò abbia un impatto sul trasferimento dei rischi al compratore.

5.4 Per particolari tipi di imballaggio, saranno conteggiati in fattura gli extra prezzo indicati nel listino-prezzi o nella conferma d'Ordine.

6 PAGAMENTI - 6.1 I pagamenti sono dovuti nei termini e con le modalità stabilite nella conferma d'ordine e/o fattura.

6.2 Salvo diversa espressa pattuizione, i pagamenti dovranno essere effettuati alle coordinate bancarie di Luxor indicate nella fattura di vendita. I pagamenti dall'Estero, effettuati mediante bonifico bancario, dovranno avvenire con opzione OUR, così che l'importo esposto in fattura sia ricevuto da Luxor al netto di oneri bancari e/o spese. Nessun soggetto terzo (in particolare agenti e rappresentanti) è autorizzato ad incassare denaro per conto di Luxor.

6.3 Il Cliente, non potrà sospendere totalmente o parzialmente i pagamenti od anche ritardarli rispetto ai termini pattuiti, nemmeno in presenza di eventuali contestazioni o denunce di vizi e difetti.

6.4 Nel caso di interruzione o sospensione dei pagamenti, il Cliente sarà considerato ad ogni effetto di legge come inadempiente, con facoltà di Luxor di addebitare spese ed interessi di cui agli artt. 5 e 6 del D.Lgs n. 192/2012, sempre salvo il diritto alla risoluzione contrattuale. Il ritardo nei pagamenti dà altresì a Luxor il diritto di escludere la garanzia per tutto il periodo durante il quale il ritardo perdura.

6.5 Il mancato rispetto da parte del Cliente dei termini di pagamento pattuiti, così come, la loro interruzione o sospensione, consentirà a Luxor di sospendere le forniture in corso e/o condizionare l'esecuzione dell'ordine in corso al saldo dell'esposizione debitoria e/o recedere da tutti gli ulteriori contratti stipulati con il Cliente, annullando le condizioni di favore (sconti e/o omaggi) eventualmente concessi.

6.6 Il Cliente non può compensare ragioni di credito che assuma di vantare nei confronti di Luxor con debiti sempre assunti nei confronti di quest'ultima, salvo formale autorizzazione della stessa Luxor.

7 CLAUSOLA RISOLUTIVA ESPRESSA - 7.1 Luxor potrà risolvere il contratto con effetti immediati nel caso in cui il Cliente venga assoggettato a procedure concorsuali o di liquidazione nonché in caso di assoggettamento a procedure esecutive e/o a protesti, e lo stato delle condizioni economiche sia tale da far ragionevolmente presumere l'insolubilità dell'acquirente.

8 GARANZIA - 8.1 Luxor garantisce la conformità dei prodotti forniti, esenti da vizi che potrebbero renderli non idonei all'uso cui sono destinati. La garanzia potrà essere fatta valere qualora il difetto sia dovuto ad errori di fabbricazione o difetti di materie prime che rientrino nella responsabilità di Luxor.

8.2 La garanzia ha durata di 1 (un) anno dalla data di consegna ed è subordinata alla denuncia in forma scritta da parte del Cliente, entro 8 (otto) giorni a decorrere dalla consegna in caso di vizi apparenti, ovvero, in caso di vizi occulti, dal momento della scoperta e comunque non oltre dodici (12) mesi dalla consegna.

8.3 In caso di prodotti non conformi, e dopo aver ricevuto un rapporto dettagliato dal Cliente, Luxor potrà, a sua insindacabile scelta: a) fornire gratuitamente Franco Fabbrica al compratore prodotti dello stesso genere e quantità, dopo averne ottenuto la resa per la verifica. Qualsiasi reso deve essere sempre precedentemente concordato ed autorizzato da Luxor. La merce contestata dovrà essere rispedita in "Porto Franco" e con bolla accompagnatoria indicante i motivi della restituzione entro massimo 30 giorni dalla data del benestare di Luxor, pena la decadenza della validità dell'autorizzazione stessa.

8.4 Qualora Luxor in sede di verifica non riconosca viziati i prodotti, provvederà alla fatturazione di quelli inviati in sostituzione. Nel caso in cui non fosse possibile sostituire i Prodotti risultati difettosi, Luxor potrà emettere una nota di accredito in favore del Cliente, per un importo corrispondente al valore dei prodotti difettosi, senza che ciò comporti alcuna responsabilità in capo a Luxor per danni diretti, indiretti o consequenziali di ogni genere, derivanti da e/o connessi ai vizi o difetti dei Prodotti.

8.5 Rimane inteso che la presente garanzia non copre i casi di Installazione, uso e manutenzione, posti in essere in difformità alle istruzioni ed avvertenze riportate nei manuali di installazione, uso e manutenzione inviati in accompagnamento al prodotto, o esecuzione di interventi di installazione e/o riparazione eseguiti da personale non qualificato.

8.6 È comunque esclusa l'operatività della garanzia nelle ipotesi in cui l'Acquirente si renda inadempiente alle obbligazioni contrattuali.

8.7 La presente garanzia è esclusiva ed in sostituzione di ogni altra garanzia scritta, orale od implicita a cui, con l'accettazione delle presenti Condizioni generali, il Cliente dichiara di rinunciare espressamente, ivi compreso, il diritto di regresso derivante dalla vendita e/o installazione dei Prodotti a consumatore non professionista.

9. RISERVA DI PROPRIETÀ 9.1 La vendita dei Prodotti Luxor S.p.A viene effettuata con patto di riservato dominio. Pertanto i prodotti rimarranno di proprietà di Luxor S.p.A. fino al totale pagamento del prezzo da parte dell'acquirente.

10 CESSIONE DEL CONTRATTO 10.1 È vietata la cessione a terzi del Contratto e/o di alcun interesse, diritto e obbligazione ad esso collegati, senza specifica approvazione scritta da parte di Luxor.

11 PRIVACY - 11.1 Il Cliente dichiara di avere preso visione dell'informativa ai sensi degli artt. 13 e 14 del Regolamento (UE) 2016/679 (GDPR) e s.m.i, consultabili al seguente indirizzo, <https://luxor.it/privacy-policy>, e con l'accettazione delle presenti CGC, fornisce il consenso al trattamento dei propri dati personali

11.2 I dati personali forniti dal Cliente, saranno trattati da Luxor, anche tramite soggetti esterni, per permettere gli adempimenti di obblighi di legge, nonché gli adempimenti informativi, amministrativi e commerciali connessi all'esecuzione del rapporto contrattuale.

12 LEGGE APPLICABILE E FORO COMPETENTE - 12.1 Contratto è regolato dal diritto italiano. Quanto non espressamente disciplinato dalle presenti CVG, sarà regolato dalle norme sulla vendita previste dagli articoli 1470 e seguenti del Codice Civile.

12.2 Le Parti escludono espressamente l'applicazione della Convenzione di Vienna sui contratti per la vendita internazionale di beni. Tutte le controversie che dovessero insorgere in relazione al Contratto, comprese quelle inerenti alla sua validità, interpretazione, esecuzione e risoluzione, saranno deferite in via esclusiva al Tribunale di Brescia.

12.3 In ogni caso, Luxor si riserva il diritto di agire presso il foro competente della sede del Cliente per azioni volte al recupero del credito. In tal caso troverà applicazione la legge locale.

13 CLAUSOLE FINALI - 13.1 L'eventuale nullità e/o inefficacia di una o più disposizioni delle presenti CVG, non incide sulla validità del contratto nel suo complesso.

13.2 Qualsiasi modifica al Contratto sarà valida soltanto se effettuata per iscritto e firmata da rappresentanti autorizzati di entrambe le Parti.

Il Cliente, nel dare atto di non rivestire la qualità di "consumatore", con conseguente esclusione dell'applicazione delle disposizioni di legge relative ai rapporti tra imprenditori e consumatori, dichiara di aver posto particolare attenzione alle seguenti clausole: · 1. Premesse (1.1); · 2. Ordini (2.1 - 2.2 - 2.3); · 3. Prezzi (3.2); 4. Termini di consegna (4.1 - 4.2); · 5. Spedizioni (5.1 - 5.2 - 5.3); · 6. Pagamenti (6.2 - 6.3 - 6.4 - 6.5 - 6.6); · 7 Clausola risolutiva espressa (7.1); 8. Garanzia (8.1 - 8.2 - 8.3 - 8.4 - 8.5 - 8.6 - 8.7); 9. Riserva di Proprietà (9.1); 10. Cessione del Contratto (10.1); 12. Legge applicabile e foro competente (12.1 - 12.2 - 12.3); 13 Clausole finali (13.1 - 13.2), e di approvarle specificamente

Le presenti condizioni generali risultano pubblicate sul sito Internet di LUXOR (luxor.it) dove possono essere consultate prendendone così piena e adeguata cognizione, ai sensi e per gli effetti dell'articolo 1341 e 1342 c.c.

VALIDITÀ DEL CATALOGO

I dati e gli elementi illustrativi pubblicati su questo catalogo si intendono non impegnativi. La società Luxor SpA si riserva il diritto, fermo restando le caratteristiche essenziali dei prodotti descritti, di apportare in ogni momento le eventuali modifiche che ritenesse necessarie o utili per motivi tecnici o commerciali.



LUXOR SPA

LEGAL OFFICE: Via Zanardelli, 88 - 25013 Carpenedolo (BS) Italy

ADMINISTRATIVE OFFICE, FACTORY AND COMMERCIAL OFFICE:

Via Madonnina, 94 - 25018 Montichiari (BS) Italy

Tel. +39 030 9961161 - Fax +39 030 9961165 - info@luxor.it

www.luxor.it