



60 YEARS OF ITALIAN TRADITION

Luxor is an important industrial reality, world wide and European market leader in the production of flexible hoses and components for hydro and thermo-sanitary installations. Luxor has been the expression of the most prestigious made in Italy and the great Italian high technology mechanical workings tradition for fifty years; a quality certified and recognized by the most prestigious International Certification Institutes all over the world.

Our mission is the complete customer satisfaction through a process of continuous technological research in order to make high quality, reliable products, anticipating the market evolutions by innovative partnership with both customers and suppliers. Luxor mission takes

place in its own Research and Development Centre in which new and advanced technologies are constantly analyzed and researched with continuous investments to offer the most innovative and reliable solutions for the international markets at competitive costs, ensuring strict quality controls on each single piece.

Luxor entirely plans and realizes each product, thanks to its decennial know how. The great production strength, a "slender" innovative and advanced industrial organization together with a modern logistic conception, make Luxor able to satisfy every kind of request, even customized, with fast deliveries all over the world.



Luxor is certified
ISO 9001:2015
by DEKRA Group
certification body

CERTIFICATION



Please contact our offices for information about technical specifications and certified products or visit the website of the corresponding certification body for the latter.

Please refer to www.nsf.org for a complete list of NSF approved products.
Please refer to www.iapmort.org for a complete list of UPC/CUPC approved products.



LUXOR®

7 / TRAPS

TRAPS



CONSTRUCTIVE FEATURES

Luxor's traps offer the quality and the guarantee of a Made in Italy product. The range of items, highly appreciated by the installers for their solidity and long last performance, includes the type of traps commonly used for the washbasin, bidet and washing machine water outlet.

Some of the items we are presenting are in compliance to the UNI EN274 rule and particularly are in compliance to the dimensional requirement concerning the water column which must be not less than 50 mm.

CHROME PLATED FINISH

The entire range is produced with frame chrome plating finish, which guarantees a thicker cover and consequently a higher resistance to ageing and corrosion, next to a top level aesthetic finish.

This process is carried out employing material and galvanic processes in compliance to the most severe international rules regulating health and environmental safety.

The forged bodies of the traps are produced employing brass CW617N with low lead content in compliance to the recent rule UNI EN 12165 which regulate the chemical composition.

The trap produced from brass bar are with brass CW508L in compliance to the rule UNI EN12449. In our range of products we also have available traps in chromed ABS with excellent surface hardness, chemical resistance to external agents and shockproof.

The wall cover, polished and chromed, are both in AISI 430 and also in brass and are weatherproof and resisting to the oxidation which could occur during the normal use.





LUXOR®

TRAPS

7.1 / ST SERIES

ST SERIES

STANDARD TRAPS



Luxor's traps offer the quality and the guarantee of a Made in Italy product.

The range of items, highly appreciated by the installers for their solidity and long last performance, includes the type of traps commonly used for the washbasin, bidet.

TECHNICAL DATA



Body material

CW 617 N - DW UNI-EN 12165:2016



Wall cover material

AISI 430



Shank and sleeve material

CW 508L



Finish

Chrome

FIELDS OF APPLICATION



washbasins



kitchen
washbasins



bidet

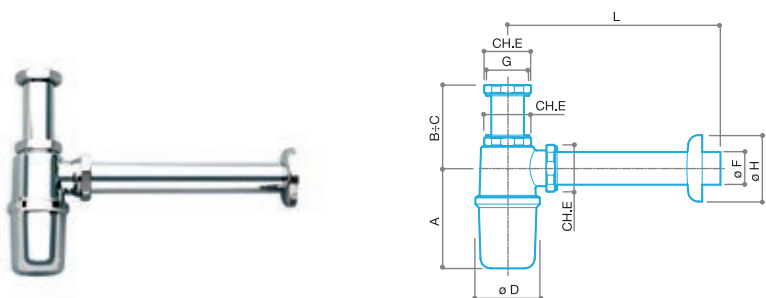

SIF 001

Bottle brass chromed trap without drain, with inspection cap, with stainless steel wall cover.

CODE	SIZE	Ø PIPE x L mm	A	B	C	D	E	F	G	H	L			
93323401	G 1"	26 x 200	80	35	105	55	36	26	G 1"	75	223	434	10	40
93323403		26 x 250	80	35	105	55	36	26	G 1"	75	273	442	10	40
93323404		26 x 250	80	75	145	55	36	26	G 1"	75	273	450	10	40

93324201	G 1 1/4"	32 x 200	98	35	105	64	44	32	G 1 1/4"	75	223	496	10	40
93324203		32 x 250	98	35	105	64	44	32	G 1 1/4"	75	273	504	10	40
93324204		32 x 250	98	75	145	64	44	32	G 1 1/4"	75	273	512	10	40

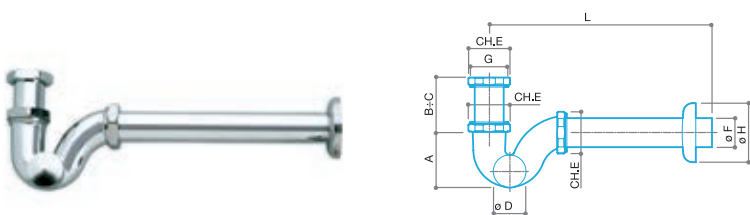

SIF 002

"S" trap for bidet. Brass chromed trap without drain, with inspection cap, with stainless steel wall cover.

CODE	SIZE	Ø PIPE x L mm	A	B	C	D	E	F	G	H	L			
93363401	G 1"	26 x 200	50	85	95	30	36	26	G 1"	75	265	356	10	40
93363403		26 x 250	50	85	95	30	36	26	G 1"	75	315	364	10	40
93363404		26 x 250	50	125	135	30	36	26	G 1"	75	315	372	10	40

93364201	G 1 1/4"	32 x 200	60	70	85	36	44	32	G 1 1/4"	75	265	452	10	40
93364203		32 x 250	60	70	85	36	44	32	G 1 1/4"	75	315	460	10	40
93364204		32 x 250	60	110	125	36	44	32	G 1 1/4"	75	315	468	10	40

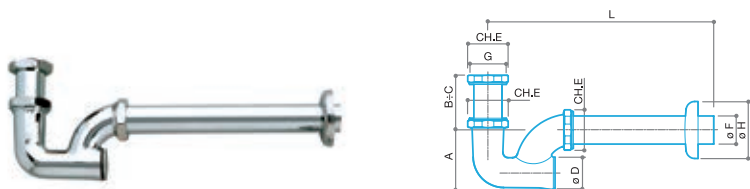

SIF 003

Column trap for wash basin. Brass chromed trap without drain, with inspection cap, with stainless steel wall cover.



CODE	SIZE	Ø PIPE x L mm	A	B	C	D	E	F	G	H	L			
93403401	G 1"	26 x 200	65	80	90	32	36	26	G 1"	75	282	384	10	40
93403403		26 x 250	65	80	90	32	36	26	G 1"	75	332	392	10	40
93403404		26 x 250	65	120	130	32	36	26	G 1"	75	332	400	10	40

93404201	G 1 1/4"	32 x 200	67	80	90	36	44	32	G 1 1/4"	75	276	458	10	40
93404203		32 x 250	67	80	90	36	44	32	G 1 1/4"	75	326	466	10	40
93404204		32 x 250	67	120	130	36	44	32	G 1 1/4"	75	326	474	10	40

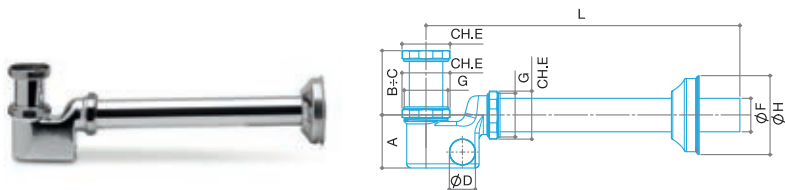
* shank 120 mm



**SIF 004**

Compact trap. Brass chromed trap without drain, with inspection cap, with stainless steel wall cover.

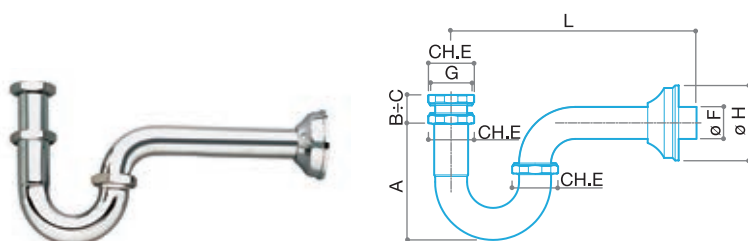
CODE	SIZE	Ø PIPE x L mm	A	B	C	D	E	F	G	H	L			
93444203	G 1"1/4	32 x 250	51	30	50	25	44	32	G 1"1/4	75	300	571	10	40



**SIF 017**

Trap for wash basin. Brass pipe trap without drain, with chromed brass wall cover.

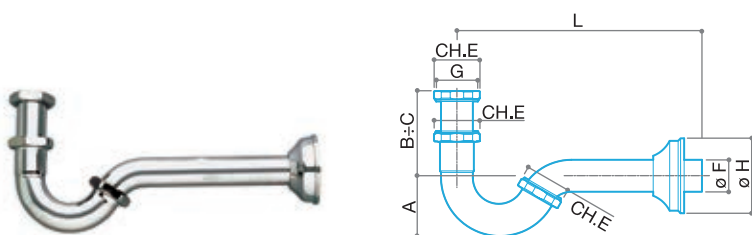
CODE	SIZE	A	B	C	D	E	F	G	H	L			
93544200	G 1"1/4	118	28	65	-	44	32	G 1"1/4	75	317	400	10	40

**SIF 018**

Trap for bidet. Brass pipe trap without drain, with chromed brass wall cover.

CODE	SIZE	A	B	C	D	E	F	G	H	L			
93524200	G 1"1/4	62	80	100	-	44	32	G 1"1/4	75	310	396	10	40



LUXOR®

TRAPS

7.2 / PREMIUM SERIES

PREMIUM SERIES

LUXURY TRAPS

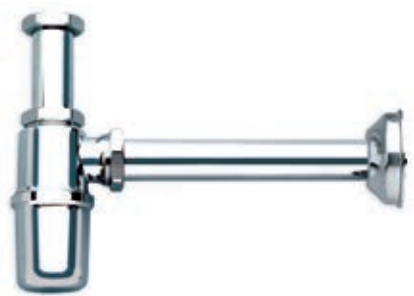

Luxor's traps offer the quality and the guarantee of a Made in Italy product.

The range of items, highly appreciated by the installers for their solidity and long last performance, includes the type of traps commonly used for the washbasin, bidet.

TECHNICAL DATA



Body material

CW 617 N - DW UNI-EN 12165:2016



Wall cover material

CW 508L



Shank and sleeve material

CW 508L



Finish

Chrome

FIELDS OF APPLICATION



washbasins



kitchen
washbasins



bidet

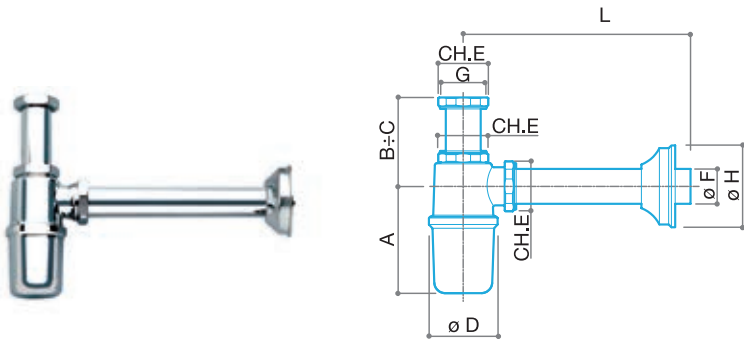

SIF 005

Luxury bottle trap. Brass chromed trap without drain, with inspection cap, with chromed brass wall cover.

CODE	SIZE	Ø PIPE x L mm	A	B	C	D	E	F	G	H	L			
93023400	G 1"	26 x 250	80	35	105	55	36	26	G 1"	75	273	438	10	40
93023404		26 x 250	80	75	145	55	36	26	G 1"	75	273	446	10	40

93024200	G 1 1/4	32 x 250	98	35	105	64	44	32	G 1 1/4	75	273	572	10	40
93024204		32 x 250	98	75	145	64	44	32	G 1 1/4	75	273	578	10	40

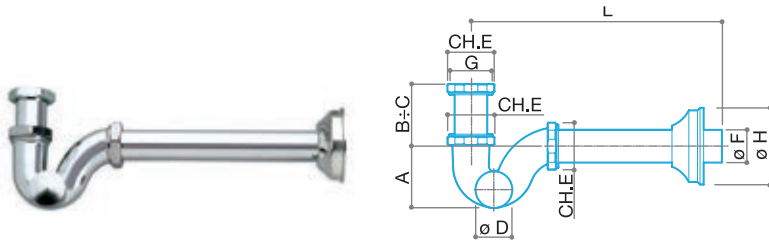

SIF 006

Luxury "S" trap for bidet. Brass chromed trap without drain, with inspection cap, with chromed brass wall cover.

CODE	SIZE	Ø PIPE x L mm	A	B	C	D	E	F	G	H	L			
93163400	G 1"	26 x 250	50	85	95	30	36	26	G 1"	75	315	360	10	40
93163404		26 x 250	50	125	135	30	36	26	G 1"	75	315	368	10	40

93164200	G 1 1/4	32 x 250	60	70	85	36	44	32	G 1 1/4	75	315	454	10	40
93164204		32 x 250	60	110	125	36	44	32	G 1 1/4	75	315	462	10	40

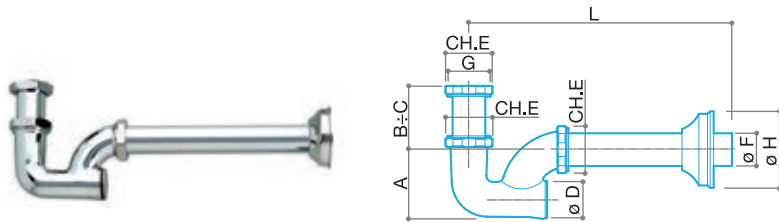

SIF 007

Luxury column trap for wash basin. Brass chromed trap without drain, with inspection cap, with chromed brass wall cover.

CODE	SIZE	Ø PIPE x L mm	A	B	C	D	E	F	G	H	L			
93203400	G 1"	26 x 250	65	80	90	32	36	26	G 1"	75	332	388	10	40
93203404		26 x 250	65	120	130	32	36	26	G 1"	75	332	396	10	40

93204200	G 1 1/4	32 x 250	67	80	90	36	44	32	G 1 1/4	75	332	460	10	40
93204204		32 x 250	67	120	130	36	44	32	G 1 1/4	75	332	468	10	40

* shank 120 mm



LUXOR®

TRAPS

7.3 / PL SERIES

PL SERIES

ABS TRAPS



Luxor's traps offer the quality and the guarantee of a Made in Italy product.

The range of items, highly appreciated by the installers for their solidity and long last performance, includes the type of traps commonly used for the washbasin, bidet.

In each box of traps in ABS you will find a pair of gloves for a better care and cleaning of the traps during the installation.

TECHNICAL DATA



Body material

Chromed ABS



Wall cover material

Chromed ABS



Shank and sleeve material

Chromed ABS



Finish

Chrome

FIELDS OF APPLICATION



washbasins



kitchen
washbasins



bidet

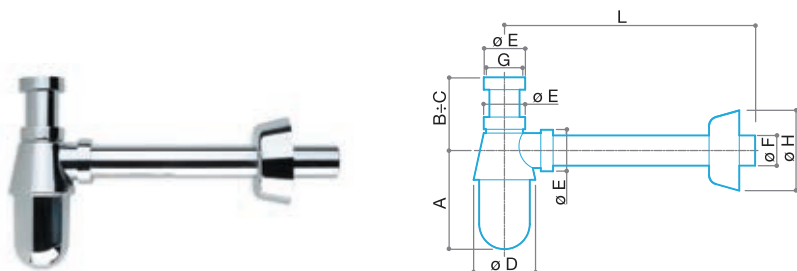

SIF 008

Bottle trap in abs. Chromed ABS trap, without drain, inspectable, with wall cover in chromed ABS.

CODE	SIZE	Ø PIPE x L mm	A	B	C	D	E	F	G	H	L			
96023400	G 1"	26 x 250	84	45	121	61	35	26	G 1"	85	287	202	1	10
* 96024200	G 1 1/4	32 x 250	105	48	128	66	44	32	G 1 1/4	85	293	272	1	10

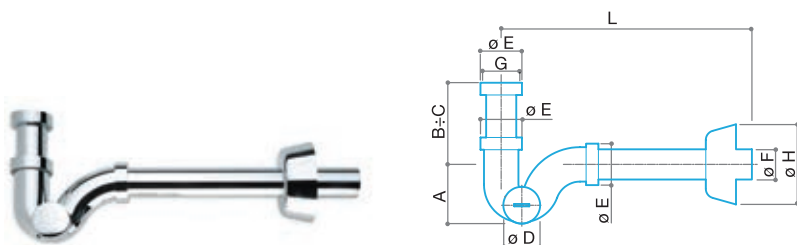

SIF 009

"S" trap for bidet in abs. Chromed ABS trap, without drain, inspectable, with wall cover in chromed ABS.

CODE	SIZE	Ø PIPE x L mm	A	B	C	D	E	F	G	H	L			
96163400	G 1"	26 x 250	68	57	102	35	35	26	G 1"	85	342	188	1	10
96164200	G 1 1/4	32 x 250	63	87	132	39	44	32	G 1 1/4	85	342	228	1	10

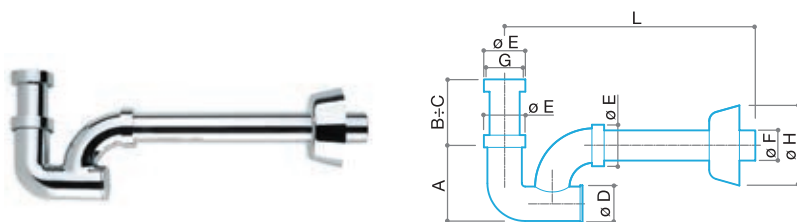

SIF 010

Column trap for wash basin in abs. Chromed ABS trap, without drain, inspectable, with wall cover in chromed ABS.

CODE	SIZE	Ø PIPE x L mm	A	B	C	D	E	F	G	H	L			
96203400	G 1"	26 x 250	67	63	92	35	35	26	G 1"	85	345	174	1	10
96204200	G 1 1/4	32 x 250	80	70	110	39	44	32	G 1 1/4	85	350	236	1	10

* Trap in compliance with standard EN 274 with water column > 50 mm



LUXOR®

TRAPS

7.4 / 50th SERIES

50th SERIES

FURNISHING TRAPS



CONSTRUCTIVE FEATURES

The furnishing 50th Series are a distinguished excellent product Made in Italy for its design, for its top level finishing and for the technical feature in compliance to the rule UNI EN274. In particular they are in compliance to the dimensional requirement concerning the water column which must be not less than 50 mm.

CHROME PLATING FINISH

The traps are hand polished and produced with frame chrome plating finish, which guarantees a thicker cover and consequently a higher resistance to ageing and corrosion, next to a top level aesthetic finish. This process is carried out employing material and galvanic processes in compliance to the most severe international rules regulating health and environmental safety.

BODY

The bodies of the traps are produced employing brass CW617N with low lead content in compliance to the recent rule UNI EN 12165 giving the guarantee of a product hygienically safe and reliable. The tightening clamps and the inspection cap are in brass CW614N with low lead content in compliance to the European rule UNI EN 12164 which regulates the chemical composition.

DOUBLE O-RING TIGHTNESS

The peculiar and exclusive feature of the furnishing trap Prestige is the double o-ring tightness and the slip-off sleeve.

This system allows to connect the trap to the drain and allows the installers to cut in a second step the drain sleeve without spoiling the whole trap due to a wrong cut on the drain pipe.

This technical solution makes Luxors's furnishing trap a sound reference point for any kind of aesthetic, functioning and installation requirement.

INSPECTION CAP

The brass inspection cap is equipped with an easy cut to facilitate the open/close operation and to simplify the periodical cleaning maintenance. It is not necessary to use any special tool for the inspection, a small coin is just enough.

DRAIN COVER

The wall drain cover is in brass. It is ageing and corrosion resistant and it is polished and chromed on frame with a top level finishing.

TECHNICAL DATA



Body material

CW 617 N - DW UNI-EN 12165:2016



Wall cover material

CW 508L



Shank and sleeve material

CW 508L



Finish

Chrome

FIELDS OF APPLICATION



washbasins



kitchen washbasins

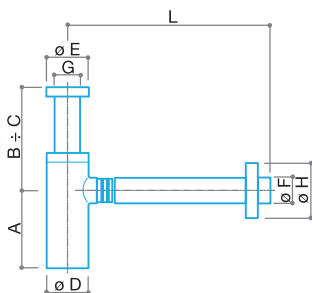

SIF 011
Furnishing brass trap without drain, chrome or black finish, with sleeves, inspection cap, wall cover and collar in chromed brass.

CODE	SIZE	Ø PIPE x L mm	FINISH	A	B	C	D	E	F	G	H	L			
** 93654200	G 1"1/4	32 x 320	CHROME	95	58	128	52	52	32	G 1"1/4	68	356	950	1	5
** 93654200N	G 1"1/4	32 x 320	BLACK	95	58	128	52	52	32	G 1"1/4	68	356	950	1	5

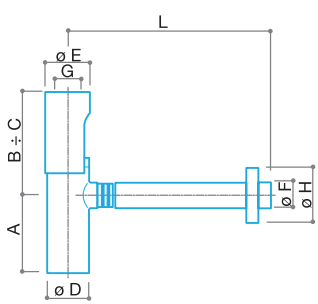

SIF 012
Slide-away trap. Furnishing brass chromed trap, without drain, with sleeves, inspection cap, wall cover, collar and shell in chromed brass.

CODE	SIZE	Ø PIPE x L mm	A	B	C	D	E	F	G	H	L			
** 93664200	G 1"1/4	32 x 320	95	58	128	52	55	32	G 1"1/4	68	356	1.060	1	5

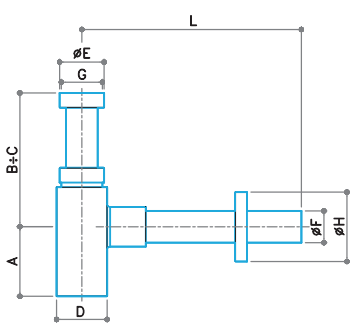

SIF 013
Square trap. Furnishing brass chromed trap, without drain, with sleeves, inspection cap, wall cover and collar in chromed brass.

CODE	SIZE	Ø PIPE x L mm	A	B	C	D	E	F	G	H	L			
93634200	G 1" 1/4	32 x 300	70	80	180	50	44	32	G 1"1/4	70	325	890	1	5

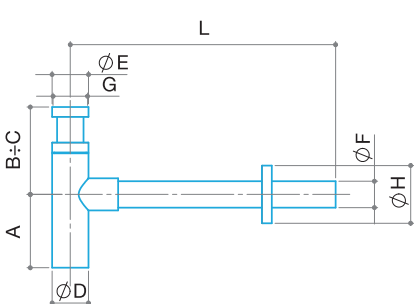

SIF 014
Round trap. Furnishing brass chromed trap, without drain, with sleeves, inspection cap, wall cover and collar in chromed brass.

CODE	SIZE	Ø PIPE x L mm	A	B	C	D	E	F	G	H	L			
93624200	G 1" 1/4	32 x 300	89	75	175	44	44	32	G 1"1/4	70	322	680	1	5

** Trap in compliance with standard EN 274 with water column > 50 mm



LUXOR®

TRAPS

7.5 / K SERIES

K SERIES

TRAPS FOR DOMESTIC APPLIANCES



FIELDS OF APPLICATION



washing machines



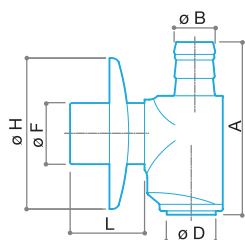

dishwasher



SIF 019

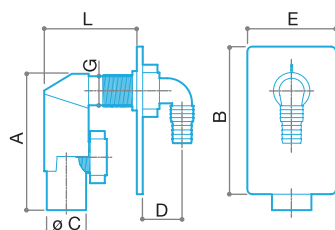

Drain trap for domestic appliances.
Brass chromed trap with check hole
for washing machine and dishwasher
outlet.

CODE	SIZE	A	B	C	D	E	F	G	H	L			
93733400	32 x 40	92	22	-	30	-	32	-	80	40	360	2	20



SIF 020

Drain trap for domestic appliances.
Built-in white plastic trap, with check
hole for dishwasher and washing
machine.

CODE	SIZE	A	B	C	D	E	F	G	H	L			
96264800	40	139	150	40	40	90	-	G 1"	-	94	176	1	50



LUXOR®

TRAPS

7.6 / DRAIN PIPES AND ACCESSORIES

DRAIN PIPES AND ACCESSORIES

**CONSTRUCTIVE FEATURES**

The drain pipes are produced in brass CW508L with low lead content in compliance to the rule UNI EN12449.

RANGE

The range includes: frame chrome plated smooth pipes, pipes with safety end, elbow pipes, and extensions to guarantee a higher resistance to corrosion and ageing.





The chrome process is carried out using material and galvanic methods in compliance to the most strict international rules regulating health and environmental safety.

WALL COVER

The wall cover, polished and chromed, are in both AISI 430 and also in brass and are weatherproof and resisting to the oxidation which could occur during the normal use.





**TUB 009**

Smooth chrome-plated brass drain pipe.

CODE	SIZE	A	B	C	D	E	F	G	H	L				
35012620	Ø 26	26	-	-	-	-	-	-	-	200	52	-	10	80
35012625		26	-	-	-	-	-	-	-	250	60	-	10	80
35012630		26	-	-	-	-	-	-	-	300	72	-	10	80
35012699		26	-	-	-	-	-	-	-	1000	248	5	-	-
35013020	Ø 30	30	-	-	-	-	-	-	-	200	56	-	10	80
35013025		30	-	-	-	-	-	-	-	250	68	-	10	80
35013030		30	-	-	-	-	-	-	-	300	86	-	10	80
35013099		30	-	-	-	-	-	-	-	1000	290	5	-	-
35013220	Ø 32	32	-	-	-	-	-	-	-	200	64	-	10	80
35013225		32	-	-	-	-	-	-	-	250	72	-	10	80
35013230		32	-	-	-	-	-	-	-	300	88	-	10	80
35013250		32	-	-	-	-	-	-	-	500	148	5	-	-
35013299		32	-	-	-	-	-	-	-	1000	300	5	-	-
35014020	Ø 40	40	-	-	-	-	-	-	-	200	80	-	5	-
35014025		40	-	-	-	-	-	-	-	250	116	-	5	-
35014030		40	-	-	-	-	-	-	-	300	134	-	5	-
35014099		40	-	-	-	-	-	-	-	1000	464	1	-	-

**TUB 010**

Chromed brass outlet pipe with collar.

CODE	SIZE	A	B	C	D	E	F	G	H	L				
35022620	Ø 26	26	30	-	-	-	-	-	-	200	52	-	10	80
35022625		26	30	-	-	-	-	-	-	250	62	-	10	80
35022630		26	30	-	-	-	-	-	-	300	74	-	10	80



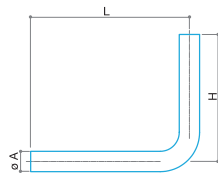

35023020	Ø 30	30	38	-	-	-	-	-	-	200	52	-	10	80
35023025		30	38	-	-	-	-	-	-	250	72	-	10	80
35023030		30	38	-	-	-	-	-	-	300	84	-	10	80

35023220	Ø 32	32	38	-	-	-	-	-	-	200	58	-	10	80
35023225		32	38	-	-	-	-	-	-	250	74	-	10	80
35023230		32	38	-	-	-	-	-	-	300	86	-	10	80

35024020	Ø 40	40	44	-	-	-	-	-	-	200	114	-	5	-
35024025		40	44	-	-	-	-	-	-	250	122	-	5	-
35024030		40	44	-	-	-	-	-	-	300	130	-	5	-

**TUB 011**

Chromed brass outlet pipe with 90° elbow.

CODE	SIZE	A	B	C	D	E	F	G	H	L				
35050400	Ø 30	30	-	-	-	-	-	-	150	250	119	5	-	35
35050200		30	-	-	-	-	-	-	200	300	164	5	-	25

35050600	Ø 32	32	-	-	-	-	-	-	200	250	230	5	-	25
----------	------	----	---	---	---	---	---	---	-----	-----	-----	---	---	----

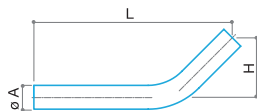
**TUB 012**

Chromed brass outlet pipe with 45° elbow.

CODE	SIZE	A	B	C	D	E	F	G	H	L				
35060225	Ø 30	30	-	-	-	-	-	-	75	250	102	5	-	50

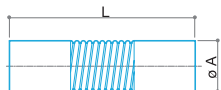
**TUB 013**

Bendable chrome-plated brass drain pipe.

CODE	SIZE	A	B	C	D	E	F	G	H	L				
35032625	Ø 26	26	-	-	-	-	-	-	-	250	66	-	10	-
35032630		26	-	-	-	-	-	-	-	300	86	-	10	-
35033025	Ø 30	30	-	-	-	-	-	-	-	250	86	-	10	-
35033030		30	-	-	-	-	-	-	-	300	102	-	10	-
35033225	Ø 32	32	-	-	-	-	-	-	-	250	94	-	10	-
35033230		32	-	-	-	-	-	-	-	300	99	-	10	-

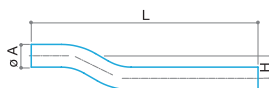
**TUB 014**

Eccentric outlet chromed brass pipe.

CODE	SIZE	A	B	C	D	E	F	G	H	L				
35152630	Ø 26	26	-	-	-	-	-	-	30	300	150	-	10	-
35153030	Ø 30	30	-	-	-	-	-	-	30	300	164	-	10	-
35153230	Ø 32	32	-	-	-	-	-	-	30	300	178	-	10	-

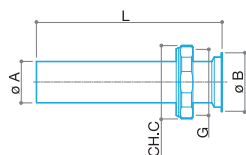
**TUB 015**

Chromed brass pipe with collar and nut.

CODE	SIZE	A	B	C	D	E	F	G	H	L				
35042620	Ø 26	26	37	44	-	-	-	G 1"1/4	-	200	86	-	10	-

**TUB 016**

Chromed brass with extension and o-ring.

CODE	SIZE	A	B	C	D	E	F	G	H	L				
35160026	Ø 26	26	28	33	60	-	-	-	-	130	32	-	10	-
35160030	Ø 30	30	32	37	60	-	-	-	-	130	35	-	10	-
35160032	Ø 32	32	33	41	60	-	-	-	-	130	38	-	10	-
35160040	Ø 40	40	42	51	60	-	-	-	-	130	68	-	5	-

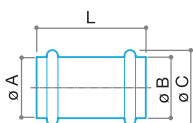
**TUB 017**

Intermediate chromed brass joint with o-ring.

CODE	SIZE	A	B	C	D	E	F	G	H	L				
35161026	Ø 26	26	28	33	-	-	-	-	-	55	22	-	10	-
35161030	Ø 30	30	32	37	-	-	-	-	-	55	28	-	10	-
35161032	Ø 32	32	33	41	-	-	-	-	-	60	34	-	10	-
35161040	Ø 40	40	42	51	-	-	-	-	-	70	53	-	5	-

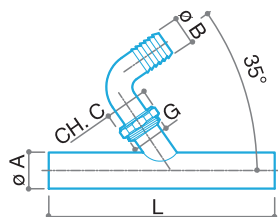

TUB 018

Chromed brass outlet pipe with elbow in chromed ABS for washing machine and dishwasher.

CODE	SIZE	A	B	C	D	E	F	G	H	L				
35200026	Ø 26	26	25	36	-	-	-	G 1"	-	200	138	-	5	-
35200032	Ø 32	32	25	36	-	-	-	G 1"	-	200	142	-	5	-

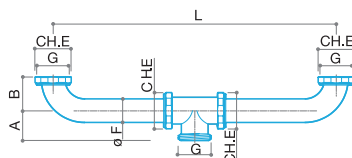

TUB 019

Chromed brass two ways fitting without drain for traps.

CODE	SIZE	A	B	C	D	E	F	G	H	L				
93504200	G 1 1/4	38	43	-	-	44	30	G 1 1/4	-	360	418	1	10	-



NUTS

Chromed brass nut for traps.

CODE	SIZE	Ø PIPE mm			
97222600CF	G 1"	26	20	25	-
97223200CF	G 1 1/4	32	24	25	-



REDUCTIONS

Chromed brass reduction to adapt the drain to various measures of traps.

CODE	F	M			
94164200	G 1 1/4	G 1"	80	25	-
94164800	G 1 1/2	G 1 1/4	112	20	-



CONICAL TRAP GASKET

Black rubber conical gasket.

CODE	SIZE	Ø PIPE mm			
97172600CF	G 1"	26	1	100	-
97173000CF	G 1 1/4	30	1	100	-
97173200CF	G 1 1/4	32	1	100	-
97174000CF	G 1 1/2	40	1	100	-



CONICAL OUTLET GASKET

Black rubber gasket to adapt outlet pipes.

CODE	SIZE	Ø PIPE mm			
60294032CF	40 x 32 G 1 1/4 G 1 1/2	-	6	50	-

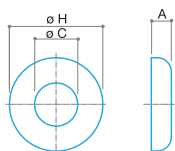
**ROS 101**

Sliding stainless steel wall cover ϕ 65 mm with round hole.

CODE	SIZE	A	B	C	D	E	F	G	H	L				
30100026CF	ϕ 65	14	-	26	-	-	-	-	65	-	12	-	50	-
30100030CF		14	-	30	-	-	-	-	65	-	12	-	50	-
30100032CF		14	-	32	-	-	-	-	65	-	12	-	50	-

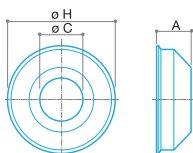
**ROS 102**

Sliding shaped stainless steel wall cover ϕ 75 mm with round hole.

CODE	SIZE	A	B	C	D	E	F	G	H	L				
30090126CF	ϕ 75	24	-	26	-	-	-	-	75	-	20	-	25	-
30090130CF		24	-	30	-	-	-	-	75	-	20	-	25	-
30090132CF		24	-	32	-	-	-	-	75	-	20	-	25	-

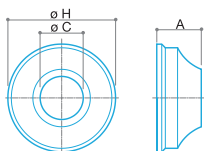

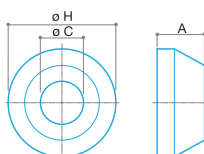

**ROS 103**

Sliding shaped stainless steel wall cover ϕ 75 mm with round hole.

CODE	SIZE	A	B	C	D	E	F	G	H	L				
30090026CF	ϕ 75	31	-	26	-	-	-	-	75	-	16	50	-	-
30090030CF		31	-	30	-	-	-	-	75	-	14	50	-	-
30090032CF		31	-	32	-	-	-	-	75	-	14	50	-	-



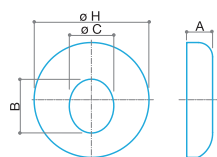

**ROS 104**

Chromed brass sliding conical wall cover ϕ 75 mm with round hole.

CODE	SIZE	A	B	C	D	E	F	G	H	L				
30070026CF	ϕ 75	33	-	26	-	-	-	-	75	-	24	25	-	-
30070030CF		33	-	30	-	-	-	-	75	-	24	25	-	-
30070032CF		33	-	32	-	-	-	-	75	-	24	25	-	-
30070040CF		33	-	40	-	-	-	-	75	-	24	25	-	-

**ROS 105**

Chromed brass sliding wall cover with oval hole.

CODE	SIZE	A	B	C	D	E	F	G	H	L				
30110030CF	ϕ 80	18	38	31	-	-	-	-	80	-	22	25	-	-
30110230CF	ϕ 110	31	38	31	-	-	-	-	110	-	64	5	-	-

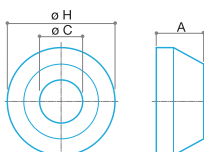

**ROS 106**

Chromed brass conical wall cover ϕ 100 mm suitable for eccentric pipe.

CODE	SIZE	A	B	C	D	E	F	G	H	L				
35120026	ϕ 100	43	-	26	-	-	-	-	100	-	58	10	-	-
35120030		43	-	30	-	-	-	-	100	-	56	10	-	-
35120032		43	-	32	-	-	-	-	100	-	56	10	-	-



**STRAIGHT SLEEVE**

White rubber sleeve for w.c. branch.

CODE	SIZE	Ø PIPE mm			
60295000	Ø 100	-	179	1	-



**ECCENTRIC SLEEVE**

White rubber sleeve for w.c. branch.

CODE	SIZE	Ø PIPE mm			
60295100	Ø 100	-	182	1	-



**UNIVERSAL CLAMP**

Rubber reduction clamp for drain pipes.

CODE	SIZE	Ø PIPE mm			
60291000	40	26-30-32	14	25	-
60291100	50	26-30-32	26	25	-
60291200	50	40	22	25	-



**STANDARD CLAMP**

Rubber reduction clamp for drain pipes.

CODE	SIZE	Ø PIPE mm			
60291300	47	26-30-32	22	25	-
60291400		40	12	25	-



**UNIVERSAL WC CLAMP**

Rubber reduction clamp for w.c.

CODE	SIZE	Ø PIPE mm			
60290200	50	30-32	28	50	-

**UNIVERSAL WC CLAMP**

Rubber reduction clamp for w.c.

CODE	SIZE	Ø PIPE mm			
60300000	60	30-32	34	50	-



Lined writing area consisting of 25 horizontal lines.

GENERAL CONDITIONS OF SALE

1 PREMISES - 1.1 The present conditions of sale apply to all supplies of Luxor Spa Products (hereafter "Luxor"). Any general conditions, and in particular the conditions of purchase of the Buyer (hereafter "Customer"), unless expressly accepted in writing by Luxor, shall not bind the latter nor exempt the Customer from the application of the present General Conditions (hereafter GSC)

2. ORDERS - 2.1 The Purchase Orders (referred to as 'Orders') are an irrevocable purchase proposal. By placing an Order, customers fully accept the present General Conditions of Sale.

2.2 Orders are considered accepted only after Luxor confirms them in writing. The Order confirmation and/or Invoice issued by Luxor will be considered as confirmation.

2.3 Any changes to the Order requested by the Customer after the sending of the Order Confirmation will only be valid and enforceable after written acceptance by Luxor. Cancellation or modification of Orders without the prior written consent of Luxor, will give Luxor the right to act to obtain reimbursement of the costs incurred, without prejudice to the right to compensation for greater damages.

3 PRICES - 3.1 Luxor products will be invoiced based on the current price list at the time the order is accepted. Prices do not include VAT or any other taxes.

3.2 Prices listed in sales catalogues/lists are merely indicative and may be subject to change due to production cost increases. In such cases, Luxor will inform the purchaser of the price increase and provide the reasons.

4 DELIVERY TERMS - 4.1 The supplies in each individual Order will be delivered within the stated terms in the Order Confirmation.

4.2 Luxor will not be held responsible for delays in delivery that are not caused by Luxor, such as delays by third parties, including suppliers and sub-suppliers, shippers, and causes of force majeure that result in total or partial inactivity of the plants. In the cases mentioned above, the Customer cannot refuse delivery of the goods, even if it is only partial, nor can they use a delay in delivery as a reason to terminate the contract or claim damages.

5 SHIPMENTS - 5.1 The products will be delivered to the 'Assigned Port' (Incoterms 2020 EXW), with transport costs and risks borne by the buyer, unless otherwise agreed.

5.2 Even in the case of agreed delivery in "Free Port" (Incoterms 2020 DDP) with costs borne by Luxor, the goods will still travel at the buyer's risk. Regardless of the delivery terms agreed upon by the parties, the risks will pass to the buyer at the latest with delivery to the first carrier.

5.3 The transfer of ownership of the goods is suspended until the full price has been paid, but this does not affect the transfer of risk to the purchaser.

5.4 If special packaging is required, an additional charge as indicated in the price list or order confirmation will be added to the invoice.

6 PAYMENTS - 6.1 Payments are due as per the terms and manner specified in the order confirmation and/or invoice.

6.2 Unless otherwise expressly agreed, payments must be made to the bank details mentioned in the sales invoice. For payments made from abroad via bank transfer, the OUR option must be selected to ensure that Luxor receives the net amount on the invoice after deducting bank charges and expenses. Luxor does not authorize any third parties, including agents and representatives, to collect money on its behalf.

6.3 The Customer is not permitted to suspend or delay payments, even in the event of claims or complaints of defects, and must adhere to the agreed terms.

6.4 In case of payment interruption or suspension, the Customer will be considered in default. Luxor reserves the right to charge expenses and interest as per Art. 5 and 6 of D.Lgs n. 192/2012, without prejudice to the right to terminate the contract. Delayed payment may also result in Luxor excluding the guarantee for the entire period of delay.

6.5 If the Customer fails to adhere to the agreed payment terms, or interrupts or suspends payment, Luxor reserves the right to suspend any ongoing supplies and/or make the execution of the current order conditional on the payment of the outstanding debt. Luxor may also withdraw from any further contracts with the Customer and cancel any previously granted favourable conditions, such as discounts or free gifts.

6.6 The Customer is not permitted to offset any claims they may have against Luxor with debts they owe to Luxor, unless formally authorised by Luxor

7 EXPRESS TERMINATION CLAUSE - 7.1 Luxor may terminate the contract immediately if the Customer is undergoing bankruptcy or liquidation proceedings, as well as in the event that the Customer is subject to execution proceedings and/or protests and the economic conditions suggest the purchaser is insolvent.

8 WARRANTY - 8.1 Luxor guarantees the conformity of the products supplied, free from defects that could make them unsuitable for their intended use. The guarantee may be invoked if the defect is due to

manufacturing errors or defects in raw materials that are the responsibility of Luxor.

8.2 Unless otherwise expressly agreed, the guarantee lasts for one (1) year from the date of delivery. The Customer must make a written complaint within eight (8) days from delivery in the case of apparent defects, or, in the case of hidden defects, from the time of discovery and in any event not later than twelve (12) months from delivery.

8.3 In the event of non-conforming products, Luxor may, at its discretion, provide the Buyer with replacement products of the same type and quantity free of charge ex works, after verifying the returned products. Any return must always be previously agreed and authorised by Luxor. The goods in question must be returned 'carriage paid' along with a note explaining the reason for the return within 30 days of Luxor's approval. Failure to do so will result in the authorization becoming invalid.

8.4 If Luxor does not recognize the defective products upon verification, it will invoice those sent as replacements. If Luxor does not recognize the defective products upon verification, they will invoice the replacements. If Luxor is unable to replace defective products, they may issue a credit note to the customer for the value of the defective products. This does not imply any responsibility on Luxor for direct, indirect, or consequential damages resulting from or connected to the defects or faults of the products.

8.5 It is important to note that this guarantee does not cover instances where the product has been installed, used or maintained in a manner that is contrary to the instructions and warnings provided in the installation, use, and maintenance manuals that were included with the product. Additionally, any installation or repair work should only be carried out by qualified personnel.

8.6 The guarantee will not apply if the Purchaser breaches their contractual obligations.

8.7 This warranty is the only warranty and replaces any other written, oral or implied warranties. By accepting these General Terms and Conditions, the Purchaser expressly waives any right of recourse arising from the sale and/or installation of the Products to a non-professional consumer.

9. RESERVATION OF PROPERTY 9.1 The sale of Luxor S.p. A's Products is carried out under reservation of ownership. Therefore the products will remain the property of Luxor S.p.A. until the full payment of the price by the buyer.

10 TRANSFER OF THE CONTRACT 10.1 It is forbidden to transfer the Contract and/or any interest, right and obligation connected to it to third parties without specific written approval by Luxor.

11 PRIVACY - 11.1 The Customer confirms that they have read the information regarding the processing of their personal data, as required by Articles 13 and 14 of Regulation (EU) 2016/679 (GDPR) as amended. The information can be found at <https://luxor.it/privacy-policy>. By accepting these GTC, the Customer consents to the processing of their personal data.

11.2 Luxor will process the personal data provided by the Customer, including through external parties, to fulfil legal obligations and carry out administrative and commercial tasks related to the contractual relationship.

12 APPLICABLE LAW AND COURT OF JURISDICTION - 12.1 Contract is governed by Italian law. Anything not expressly governed by these GVCs shall be governed by the rules on sale provided for in articles 1470 et seq. of the Italian Civil Code.

12.2 The Parties expressly exclude the application of the Vienna Convention on Contracts for the International Sale of Goods. Any disputes related to the Contract, including those regarding its validity, interpretation, execution, and termination, must be referred exclusively to the Court of Brescia.

12.3 Luxor reserves the right to take legal action at the competent court of the Customer's location to recover any outstanding debts. The local law will apply in this case.

13 FINAL CLAUSES - 13.1 The possible nullity and/or ineffectiveness of one or more provisions of these GTC shall not affect the validity of the Contract as a whole.

13.2 Any amendment to the Contract shall be valid only if made in writing and signed by authorised representatives of both Parties.

The customer acknowledges that they are not a 'consumer' and therefore the provisions of law relating to relations between entrepreneurs and consumers do not apply. The customer declares that they have paid particular attention to the following clauses: Introduction (1.1), Orders (2.1-2.3), Prices (3.2), Delivery Terms (4.1-4.2), Shipping (5.1-5.3), and 6. The following sections require approval: Payments (6.2 - 6.3 - 6.4 - 6.5 - 6.6); 7 Express Termination Clause (7.1); 8 Warranty (8.1 - 8.2 - 8.3 - 8.4 - 8.5 - 8.6 - 8.7); 9. Retention of Title (9.1); 10. Applicable Law and Jurisdiction (12.1 - 12.2 - 12.3); 13 Final Clauses (13.1 - 13.2), and they are to be specifically approved.

These general terms and conditions are published on LUXOR's website (<https://luxor.it/>) where they may be consulted, thereby taking full and proper cognisance thereof, pursuant to and for the purposes of Articles 1341 and 1342 of the Civil Code.