



60 YEARS OF ITALIAN TRADITION

Luxor is an important industrial reality, world wide and European market leader in the production of flexible hoses and components for hydro and thermo-sanitary installations. Luxor has been the expression of the most prestigious made in Italy and the great Italian high technology mechanical workings tradition for fifty years; a quality certified and recognized by the most prestigious International Certification Institutes all over the world.

Our mission is the complete customer satisfaction through a process of continuous technological research in order to make high quality, reliable products, anticipating the market evolutions by innovative partnership with both customers and suppliers. Luxor mission takes

place in its own Research and Development Centre in which new and advanced technologies are constantly analyzed and researched with continuous investments to offer the most innovative and reliable solutions for the international markets at competitive costs, ensuring strict quality controls on each single piece.

Luxor entirely plans and realizes each product, thanks to its decennial know how. The great production strength, a "slender" innovative and advanced industrial organization together with a modern logistic conception, make Luxor able to satisfy every kind of request, even customized, with fast deliveries all over the world.



Luxor is certified ISO 9001:2015 by DEKRA Group certification body

CERTIFICATION



Please contact our offices for information about technical specifications and certified products or visit the website of the corresponding certification body for the latter.

Please refer to www.nsf.org for a complete list of NSF approved products.
Please refer to www.iapmort.org for a complete list of UPC/CUPC approved products.



LUXOR®

3 / VALVES

BALL VALVES



CONSTRUCTIVE FEATURES

All of Luxor ball valves are manufactured in CW 617 N brass and compatible with Luxor manifolds and components. Given the wide range of dimensions and models, they suit a variety of application needs.

Luxor ball valves' pivot pin is installed from the inside. This system, known as "explosion-proof", prevents the pivot pin and its sealing system from escaping, while making external tampering impossible as well. Ball valves feature two elastomeric O-ring seals, chosen for their high resistance to ageing. As prescribed by Italian decree on drinking water supply D.M. 174/2004, the valves are machined after the nickel-plating phase, thus ensuring hygiene and an appreciable aesthetic result.

TECHNICAL DATA



Max temperature

90 °C



Max pressure

10 bar



Materials

CW617N

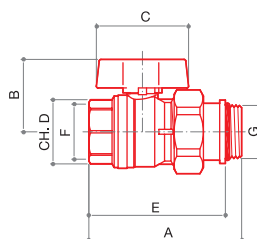

VC 471

Nickel plated full-flow ball valve, blue or red handle, with fitting article CR 498 with o-ring for connection to manifold.

CODE	SIZE	A	B	C	D	E	F	G	H	L			
68559772B	G 1/2	69	40	48	25	61	G 1/2	G 1/2	-	-	210	10	80
68559772R	G 1/2	69	40	48	25	61	G 1/2	G 1/2	-	-	210	10	80
68559805B	G 3/4	90	39	60	33	80	G 3/4	G 3/4	-	-	370	10	80
68559805R	G 3/4	90	39	60	33	80	G 3/4	G 3/4	-	-	370	10	80
68559807B	G 1"	89	43	60	41	78	G 1"	G 1"	-	-	467	5	40
68559807R	G 1"	89	43	60	41	78	G 1"	G 1"	-	-	467	5	40
68559825B	G1"1/4	123	53	72	50	109	G 1"1/4	G 1"1/4	-	-	907	3	24
68559825R	G1"1/4	123	53	72	50	109	G 1"1/4	G 1"1/4	-	-	907	3	24

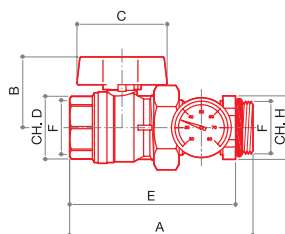

VC 471/A

Ball valve with blue or red handle and thermometer (range 0 °C÷80 °C) for connection to manifolds CD series.

CODE	SIZE	A	B	C	D	E	F	G	H	L			
68559800B	G 1"	115	43	60	41	104	G 1"	-	37	-	562	4	32
68559800R	G 1"	115	43	60	41	104	G 1"	-	37	-	562	4	32

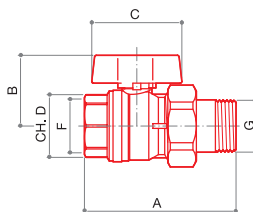

VC 472

Nickel plated full-flow ball valve, with blue or red handle and fitting.

CODE	SIZE	A	B	C	D	E	F	G	H	L			
68559774B	G 1/2	73	40	48	25	-	G 1/2	G 1/2	-	-	205	10	80
68559774R	G 1/2	73	40	48	25	-	G 1/2	G 1/2	-	-	205	10	80
68559806B	G 3/4	91	39	60	33	-	G 3/4	G 3/4	-	-	365	10	80
68559806R	G 3/4	91	39	60	33	-	G 3/4	G 3/4	-	-	365	10	80
68559808B	G 1"	95	43	60	41	-	G 1"	G 1"	-	-	487	5	40
68559808R	G 1"	95	43	60	41	-	G 1"	G 1"	-	-	487	5	40
68559818B	G1"1/4	126	53	72	50	-	G 1"1/4	G 1"1/4	-	-	904	3	24
68559818R	G1"1/4	126	53	72	50	-	G 1"1/4	G 1"1/4	-	-	904	3	24

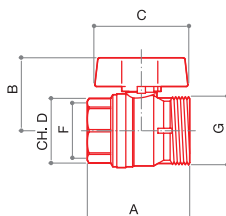

VC 475

Nickel plated full-flow ball valve, without pipe union, with blue or red handle.

CODE	SIZE	A	B	C	D	E	F	G	H	L			
68559770B	G 1/2F x G 3/4M	45	40	48	25	-	G 1/2	G 1/2	-	-	138	10	80
68559770R	G 1/2F x G 3/4M	45	40	48	25	-	G 1/2	G 1/2	-	-	138	10	80
68559811B	G 3/4F x G 1"M	59	39	60	33	-	G 3/4	G 1"	-	-	252	10	80
68559811R	G 3/4F x G 1"M	59	39	60	33	-	G 3/4	G 1"	-	-	252	10	80
68559809B	G 1"F x G1"1/4M	61	43	60	41	-	G 1"	G 1"1/4	-	-	311	5	40
68559809R	G 1"F x G1"1/4M	61	43	60	41	-	G 1"	G 1"1/4	-	-	311	5	40
68559804B	G1"1/4F x G1"1/2M	87	53	72	50	-	G 1"1/4	G 1"1/2	-	-	666	3	24
68559804R	G1"1/4F x G1"1/2M	87	53	72	50	-	G 1"1/4	G 1"1/2	-	-	666	3	24

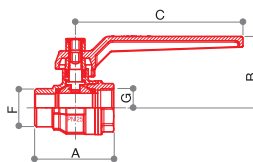

VC 476

Nickel plated full-flow ball valve, without pipe union, with blue or red lever.

CODE	SIZE	A	B	C	D	E	F	G	H	L			
68559829B	G 1"1/2	91	75	150	-	-	G 1"1/2	G 1"1/2	-	-	1400	2	16
68559829R	G 1"1/2	91	75	150	-	-	G 1"1/2	G 1"1/2	-	-	1400	2	16

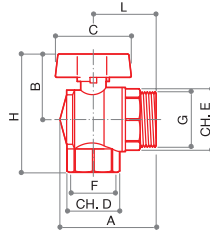

VS 470

Nickel plated full-flow ball valve, without pipe union, with blue or red handle.
*ARTICLE DISCONTINUED.

CODE	SIZE	A	B	C	D	E	F	G	H	L	⚖️	📦	📦
68559810B	G 1" F x G 1" 1/4 M	72	50	57	39	43	G 1"	G 1" 1/4	90	47	582	5	40
68559810R	G 1" F x G 1" 1/4 M	72	50	57	39	43	G 1"	G 1" 1/4	90	47	582	5	40
68559776B*	G 1" 1/4 F x G 1" 1/2 M	-	-	-	-	-	G 1" 1/4	G 1" 1/2	-	-	810	3	24
68559776R*	G 1" 1/4 F x G 1" 1/2 M	-	-	-	-	-	G 1" 1/4	G 1" 1/2	-	-	810	3	24

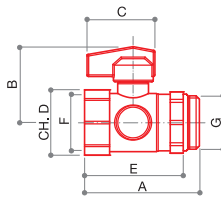

VCG 480

Nickel-plated ball valve with swivel male and blue or red handle.

CODE	SIZE	A	B	C	D	E	F	G	H	L	⚖️	📦	📦
68559719B	G 1"	71	42	42	38	61	G 1"	G 1"	-	-	368	5	40
68559719R	G 1"	71	42	42	38	61	G 1"	G 1"	-	-	368	5	40

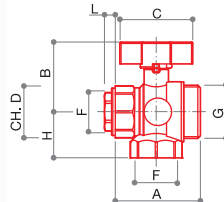

VCS 476

Straight and angle nickel plated ball valve with blue or red handle.

CODE	SIZE	A	B	C	D	E	F	G	H	L	⚖️	📦	📦
68559711B	G 1" F x G 1" 1/4 M	66,5	55	62	38	-	G 1"	G 1" 1/4	36	9	510	5	40
68559711R	G 1" F x G 1" 1/4 M	66,5	55	62	38	-	G 1"	G 1" 1/4	36	9	510	5	40

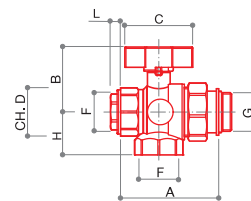



VCS 478

Straight and angle nickel plated ball valve with red/blue handle and fitting CR 498 with o-ring for connection to manifold.

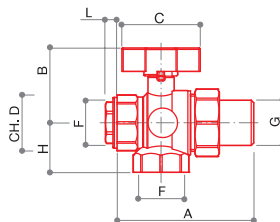
CODE	SIZE	A	B	C	D	E	F	G	H	L	⚖️	📦	📦
68559715B	G 1"	82	55	62	38	-	G 1"	G 1"	36	9	658	5	40
68559715R	G 1"	82	55	62	38	-	G 1"	G 1"	36	9	658	5	40



**VCS 477**

Straight and angle nickel-plated ball valve with blue or red handle and fitting.

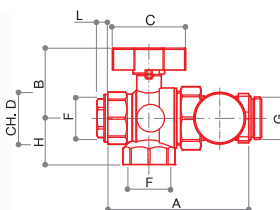
CODE	SIZE	A	B	C	D	E	F	G	H	L			
68559713B	G 1"	99	55	62	38	-	G 1"	G 1"	36	9	684	5	40
68559713R	G 1"	99	55	62	38	-	G 1"	G 1"	36	9	684	5	40



**VCS 479**

Straight and angle nickel-plated ball valve with blue or red handle and thermometer (range 0 °C ÷ 80 °C) for manifolds CD series.

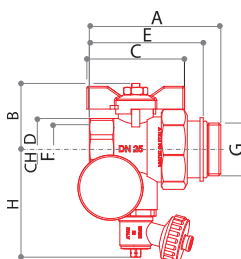
CODE	SIZE	A	B	C	D	E	F	G	H	L			
68559717B	G 1"	110	55	62	38	-	G 1"	G 1"	36	9	766	4	32
68559717R	G 1"	110	55	62	38	-	G 1"	G 1"	36	9	766	4	32

**VC 481**

Multipurpose water inlet ball valve with manual air vent, blue or red butterfly handle and CR 498 fitting with O-ring for manifold connection, complete with 0°C ÷ 80°C thermometer.

CODE	SIZE	A	B	C	D	E	F	G	H	L			
68559722B	G 1"	81	41	60	38	70	G 1"	G 1"	70	-	645	4	32
68559722R	G 1"	81	41	60	38	70	G 1"	G 1"	70	-	645	4	32

BYPASS VALVES FOR HEATING SYSTEMS



TECHNICAL DATA



Brass parts
materials
CW614N



Gaskets OR
EPDM



Spring
AISI 302

FUNCTION

Bypass valves are essential in all distribution systems with 2-way zone valves or heating bodies with adjustment valves, which enable, under certain circumstances, to bypass a circuit.

The recirculation guaranteed by the valve prevents the pump from working under improper conditions, thus avoiding imbalances among circuits operating in parallel and annoying noise caused by the increased speed of the fluid flowing through the adjustment devices.

Bypass valves VB 755 was specifically designed to be easily used with Luxor manifolds and their accessories.

This bypass valve can be installed on a variety of devices, the only requirement is the presence of two opposed G 1/2 female threads.

INSTALLATION INSTRUCTIONS

Insert the bypass valve between the inlet and the outlet pipe, downstream of the circulation pump.

As shown in the above picture, the valve consists of two parts:

- valve seat with inlet fitting;
 - adjusting element with scale from 0,2 to 0,7 bar.
- Please note: the fitting must be exclusively installed on the fluid inlet side.

ADJUSTMENT

Turn the knob until the edge is aligned with the required value on the graduated scale marked on the valve body.

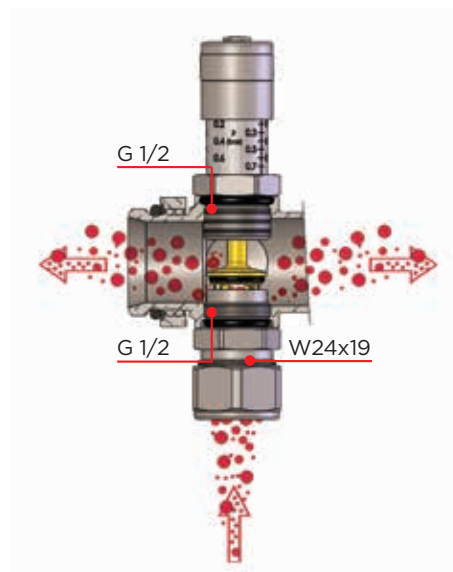
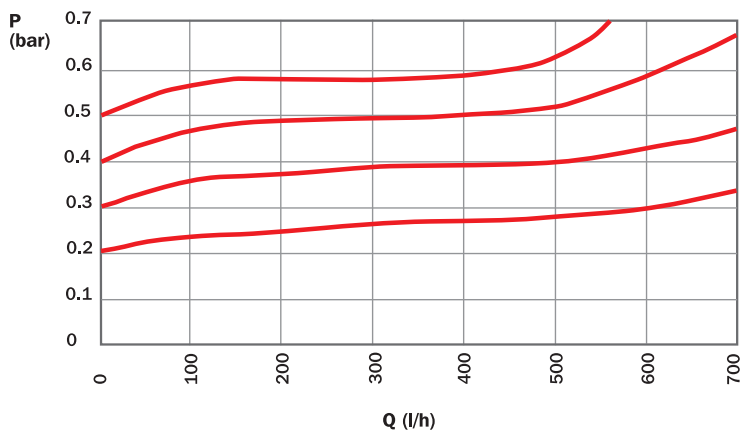

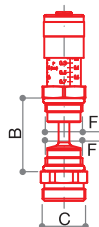

VB 755
Bypass valve.

CODE	SIZE	A	B	C	D	E	F	G	H	L			
68512109	CD G 1"	-	41	W24x19	-	-	G 1/2	-	-	-	158	10	80
68512110	CD G 1"1/4	-	51	W24x19	-	-	G 1/2	-	-	-	182	10	80

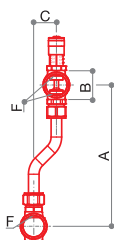

VB 750
Bypass valve.

CODE	SIZE	A	B	C	D	E	F	G	H	L			
68512101	CD G 1" x 200 mm	200	41	32	-	-	G 1/2	-	-	-	330	8	64
68512115	CD G 1" x 250 mm	250	41	32	-	-	G 1/2	-	-	-	350	8	64
68512102	CD G 1"1/4 x 200 mm	200	51	32	-	-	G 1/2	-	-	-	330	8	64

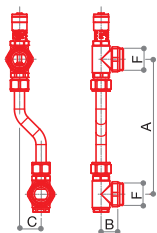

VB 751
Bypass valve with terminals for manifolds.

CODE	SIZE	A	B	C	D	E	F	G	H	L			
68512103	G 1" x 200 mm	200	25	32	-	-	G 1"	-	-	-	400	5	40
68512116	G 1" x 250 mm	250	25	32	-	-	G 1"	-	-	-	420	4	32

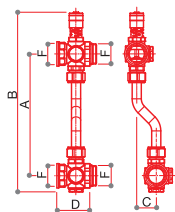

VB 752
Bypass valve with pipe unions for ball valve with or without thermometer.

CODE	SIZE	A	B	C	D	E	F	G	H	L			
68512105	G 1" x 200 mm	200	295	32	54	-	G 1"	-	-	-	766	3	24
68512117	G 1" x 250 mm	250	295	32	54	-	G 1"	-	-	-	820	3	24

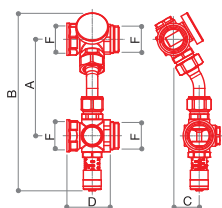





VB 753
Bypass valve kit for high temperature GM 1192.

CODE	SIZE	A	B	C	D	E	F	G	H	L			
68512108	G1"	120	223	32	54	-	G 1"	-	-	-	784	3	24

AIR VENT VALVES



TECHNICAL DATA

- 
 Max temperature
 110 °C
- 
 Max temperature
 (solar system
 version)
 200 °C
- 
 Max pressure
 10 bar
- 
 Max discharge
 pressure
 6 bar

INSTALLATION AND USE

VS air vent valves boast an excellent air flow rate and are essential to release air bubbles from heating systems. Whilst providing a high air flow capacity, their compact size enables to install VS air vent valves on gas wall-hung boilers as well as on manifolds and wherever air needs to be released from piping.

The valve allows for full air evacuation either automatically or manually, depending on the model.

The valve shall be installed in an upright position at all points in the heating system where air is likely to collect.

In order for automatic valves to operate, the brass plug shall be loosened.

When combined with check valve VS 605, automatic air vent valves may be removed without draining the system.

Automatic air vent valves are also available in a version for solar systems with a maximum operating temperature of 200°C.

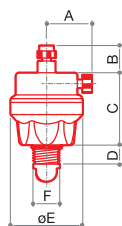

VS 602

G 3/8 automatic and manual float air vent valve reduced type. Nickel plated.

CODE	SIZE	A	B	C	D	E	F	G	H	L			
67790310N	G 3/8	25	15	40	10	40	G 3/8	-	-	-	148	15	120

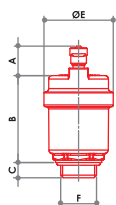

VS 604/A

Automatic air vent valve.



CODE	SIZE	FINISH	A	B	C	D	E	F	G	H	L			
67790300	G 3/8	YELLOW	17	50	9	-	40	G 3/8	-	-	-	138	10	100
67790700	G 1/2	YELLOW	17	50	9	-	40	G 1/2	-	-	-	138	10	100
67790300N	G 3/8	NICKEL PLATED	17	50	9	-	40	G 3/8	-	-	-	138	10	100
67790700N	G 1/2	NICKEL PLATED	17	50	9	-	40	G 1/2	-	-	-	138	10	100

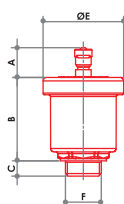

VS 601

Automatic air vent valve medium type.

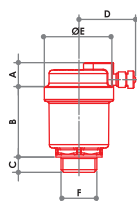

CODE	SIZE	A	B	C	D	E	F	G	H	L			
67790117	G 3/8	17	50	9	-	46	G 3/8	-	-	-	154	10	100
67790121	G 1/2	17	50	9	-	46	G 1/2	-	-	-	154	10	100
67790127	G 3/4	17	50	9	-	46	G 3/4	-	-	-	154	10	100

**VS 603**

Automatic air vent valve with side discharge.

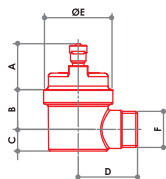

Testing
100%

CODE	SIZE	A	B	C	D	E	F	G	H	L			
67790417	G 3/8	14	41	9	34	40	G 3/8	-	-	-	160	10	100
67790421	G 1/2	14	41	9	34	40	G 1/2	-	-	-	160	10	100

**VS 606**

Automatic air vent valve with side discharge.

Testing
100%

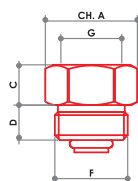

CODE	SIZE	A	B	C	D	E	F	G	H	L			
67790517	G 3/8	27	23	13	35	40	G 3/8	-	-	-	162	10	100
67790521	G 1/2	27	23	13	35	40	G 1/2	-	-	-	162	10	100

**VS 605**

Check valve for automatic air vent valve.

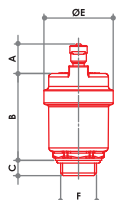
CODE	SIZE	FINISH	A	B	C	D	E	F	G	H	L			
67791200	G 3/8F x G 3/8M	YELLOW	19	-	12	9	-	G 3/8	G 3/8	-	-	18	100	800
67791400	G 3/8F x G 1/2M	YELLOW	23	-	12	9	-	G 1/2	G 3/8	-	-	40	100	800
67791600	G 1/2F x G 1/2M	YELLOW	23	-	12	9	-	G 1/2	G 1/2	-	-	30	100	800
67791200N	G 3/8F x G 3/8M	NICKEL PLATED	19	-	12	9	-	G 3/8	G 3/8	-	-	18	100	800
67791400N	G 3/8F x G 1/2M	NICKEL PLATED	23	-	12	9	-	G 1/2	G 3/8	-	-	40	100	800
67791600N	G 1/2F x G 1/2M	NICKEL PLATED	23	-	12	9	-	G 1/2	G 1/2	-	-	30	100	800

**VS 604/S**Automatic air vent valve.
200°C - 10 bar.Testing
100%

CODE	SIZE	A	B	C	D	E	F	G	H	L			
67791017	G 3/8	17	50	9	-	40	G 3/8	-	-	-	138	10	100
67791021	G 1/2	17	50	9	-	40	G 1/2	-	-	-	138	10	100

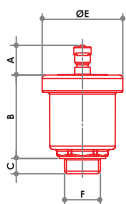

VS 601/S

Automatic air vent valve medium type.
200°C - 10 bar.



CODE	SIZE	A	B	C	D	E	F	G	H	L			
67790817	G 3/8	17	50	9	-	46	G 3/8	-	-	-	154	10	100
67790821	G 1/2	17	50	9	-	46	G 1/2	-	-	-	154	10	100
67790827	G 3/4	17	50	9	-	46	G 3/4	-	-	-	154	10	100

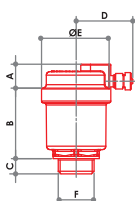

VS 603/S

Automatic air vent valve with side discharge. 200°C - 10 bar.



CODE	SIZE	A	B	C	D	E	F	G	H	L			
67790917	G 3/8	14	41	9	34	40	G 3/8	-	-	-	160	10	100
67790921	G 1/2	14	41	9	34	40	G 1/2	-	-	-	160	10	100

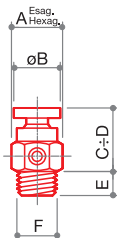

VS 610

Manual air vent valve with brass hand-wheel.



CODE	SIZE	A	B	C	D	E	F	G	H	L			
67793000	G 1/8	13	14	20	23	7	G 1/8	-	-	-	20	100	800
67793500	G 1/4	13	14	17	19	7	G 1/4	-	-	-	20	100	800
67794000	G 3/8	16	14	17	19	7	G 3/8	-	-	-	30	100	800

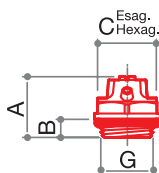

VS 620

Manual air vent valve with white ABS upper part, o-ring on thread, rotating drain.



CODE	SIZE	A	B	C	D	E	F	G	H	L			
67795417	G 3/8	21	7	19	-	-	-	G 3/8	-	-	21	100	800
67795421	G 1/2	21	8	22	-	-	-	G 1/2	-	-	24	100	800



CH 620





Butterfly key for valve VS 620.

CODE	SIZE			
67795400	-	1	200	-

RELIEF VALVES



TECHNICAL DATA

			
Temperature range	Operating pressure	Opening overpressure	Blowdown
5 ÷ 110 °C	according to setting	20%	20%

CONSTRUCTIVE FEATURES

Relief valves are used to control pressure in heat generators in heating systems and hot water build-ups in sanitary installations and water facilities. Once the set pressure is reached, the valve opens and discharges in the atmosphere, thus preventing the pressure in the system to rise to levels which may be dangerous for its components.

OPERATING PRINCIPLE

The obturator is opposed by a C72 steel calibrated spring which is preloaded according to the set pressure chosen depending on the system's maximum allowable operating pressure. Once the set pressure is reached, the obturator rises and opens the outlet completely. If the pressure decreases, the valve closes within the set tolerance values.

The diameter of the outlet connection shall be equal to the valve size or higher, so as to facilitate the needed discharge of potential.

According to Italian standards, ordinary relief valves may be installed on generators with a potential of less than 35 kW.

INSTALLATION

Relief valves may be installed either vertically or horizontally, but not upside down, in order to prevent impurities from depositing and causing malfunctioning.

Relief valves must be installed on the top of the generator, on the nearest inlet pipe or within the maximum distance prescribed by applicable standards. No shut-off valve shall be installed between the relief valve and the generator.

The valve must be sized properly before the installation in accordance with existing regulations governing specific applications. Relief valves shall not be employed for purposes other than their intended use.



Relief valves must be installed by qualified technical personnel in accordance with current regulations.

The relief valve must be installed respecting the direction of flow shown by the arrow on the valve body.



VS 910



Ordinary relief valve with diaphragm
1/2 x 1/2 F/F.

CODE	SIZE	bar			
67795001	1/2 x 1/2 F/F	1,5	110	10	100
67795002		1,8	110	10	100
67795003		2	110	10	100
67795004		2,5	110	10	100
67795005		3	110	10	100
67795006		3,5	110	10	100
67795007		4	110	10	100
67795008		5	110	10	100
67795009		6	110	10	100
67795010		7	110	10	100
67795011		8	110	10	100
67795012		10	110	10	100





VS 911

Ordinary relief valve with diaphragm
1/2 x 1/2 M/F.

CODE	SIZE	bar			
67795014	1/2 x 1/2 M/F	1,5	120	10	100
67795015		1,8	120	10	100
67795016		2	120	10	100
67795017		2,5	120	10	100
67795018		3	120	10	100
67795019		3,5	120	10	100
67795020		4	120	10	100
67795021		5	120	10	100
67795022		6	120	10	100
67795023		7	120	10	100
67795024		8	120	10	100
67795025		10	120	10	100



**VS 920**

Ordinary relief valve with diaphragm
3/4 x 3/4 F/F.

CODE	SIZE	bar			
67795027	3/4 x 3/4 F/F	1,5	170	10	100
67795028		1,8	170	10	100
67795029		2	170	10	100
67795030		2,5	170	10	100
67795031		3	170	10	100
67795032		3,5	170	10	100
67795033		4	170	10	100
67795034		6	170	10	100
67795035		7	170	10	100
67795036		8	170	10	100
67795037	10	170	10	100	



**VS 930**

Ordinary relief valve with diaphragm 1"
x 1" F/F.

CODE	SIZE	bar			
67795039	1" x 1" F/F	1,5	250	10	100
67795040		1,8	250	10	100
67795041		2,5	250	10	100
67795042		3	250	10	100
67795043		4	250	10	100
67795044		6	250	10	100



**VS 912**

Ordinary relief valve with diaphragm
1/2 x 1/2 F/F with 1/4 socket for
manometer.

CODE	SIZE	bar			
67795046	1/2 x 1/2 F/F	1,5	130	10	100
67795047		1,8	130	10	100
67795048		2	130	10	100
67795049		2,5	130	10	100
67795050		3	130	10	100
67795051		3,5	130	10	100
67795052		4	130	10	100
67795053		6	130	10	100

**VS 913**

Ordinary relief valve with diaphragm
1/2 x 1/2 M/F with 1/4 socket for
manometer.

CODE	SIZE	bar			
67795055	1/2 x 1/2 M/F	1,5	135	10	100
67795056		1,8	135	10	100
67795057		2	135	10	100
67795058		2,5	135	10	100
67795059		3	135	10	100
67795060		3,5	135	10	100
67795061		4	135	10	100
67795062		6	135	10	100

MIXING VALVE



APPLICATIONS

The 3-way valve VM 652 can be used as a diverter or mixing valve in heating and air conditioning systems using water or water-glycol **max** 30%.

The valve VM 650 is specifically intended for use in radiant panel heating systems. It works similarly to a 2-way thermostatic valve with an open bypass on the return from the radiant panel. The way B-AB is always open.

3-way valves series VM are usually open and can be used in combination with the thermostatic valve art. TT 2351 as fixed point mixers in heating systems, or electrically controlled with heads series TE and actuators series SM.

SPECIAL FEATURES

VM valves offer:

- high Kvs values;
- a precise modulation thanks to the stroke and shape of the obturator, which can immediately open both the direct passage and the bypass, thus securing flow modulation all along the stroke. (VM 652)
- very low leakage even when used in systems with high differential pressure.

TECHNICAL DATA

Maximum allowed leakage with max ΔP

- 0.05% of the Kvs for the straight passage
- 0.1% of the Kvs for the bypass

Kvs through the lower bypass around 30% of the straight passage

Way A-AB flow Kvs 3.5 - maximum allowed ΔP 0.8 bar

Way B-AB flow Kvs 2.6 - maximum allowed ΔP 1.8 bar



Max temperature

120 °C



Max pressure

16 bar



Press-forged parts materials

CW617N
UNI EN
12165:2016



Obturator materials

CW614N
UNI EN
12164:2016



Stainless steel parts materials

AISI 303



Gaskets OR

EPDM

FUNCTION

The mixing valves VM650-652 can be installed either vertically or horizontally position. Observe the connections on the body and in the picture.

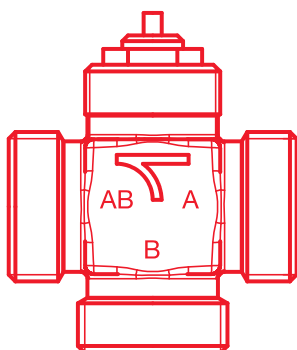

VM 650		VM 652			
MIXING VALVE		MIXING VALVE		DIVERTER VALVE	
A	inlet 1	A	inlet 1	AB	inlet
B	inlet 2	B	inlet 2	A	outlet 1
AB	mixed (bypass way B-AB)	AB	mixed	B	outlet 2
Kvs (m ³ /h)		Kvs (m ³ /h)		Kvs (m ³ /h)	
A-AB = 3,5		A-AB = 3,5		AB-A = 3,9	
B-AB = 2,6		B-AB = 2,6		AB-B = 2,8	
ΔP MAX (bar)		ΔP MAX (bar)		ΔP MAX (bar)	
A-AB = 0,8		A-AB = 0,8		AB-A = 3,5	
B-AB = -		B-AB = 1,8		AB-B = 1	

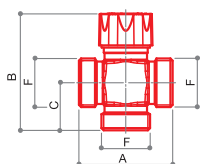

VM 650

Thermostatic mixing valve with lateral mixing and bypass.

CODE	SIZE	A	B	C	D	E	F	G	H	L	⚙️	📦	📦
68753411	G 1"	64	80	35	-	-	G 1"	-	-	-	346	1	30

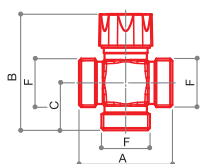

VM 652

Thermostatic mixing valve with lateral mixing.

CODE	SIZE	A	B	C	D	E	F	G	H	L	⚙️	📦	📦
68753413	G 1"	64	80	35	-	-	G 1"	-	-	-	260	1	30



DIVERTING ZONE VALVES



CONSTRUCTIVE FEATURES

VZ diverting zone valves are solid brass valves, specifically designed to be easily and quickly automated through electric actuators; they are compact and can be installed even in 80 mm deep cabinets.

TECHNICAL DATA

 Temperature range (valve) -20 °C ÷ +80 °C	 Temperature range (actuator) -20 °C ÷ +70 °C	 Working pressure see graphic drawing below
--	---	--

HYDRAULIC SCHEMES

VZ702
Three-way bypass diagram

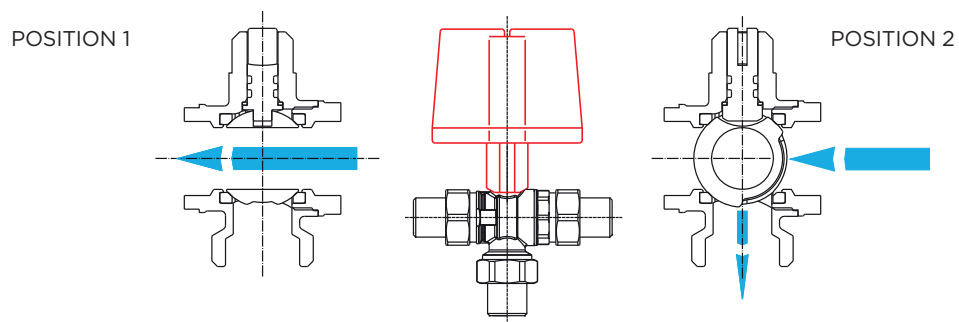

MAX WORKING PRESSURE / TEMPERATURE DIAGRAM

(test carried out with water)

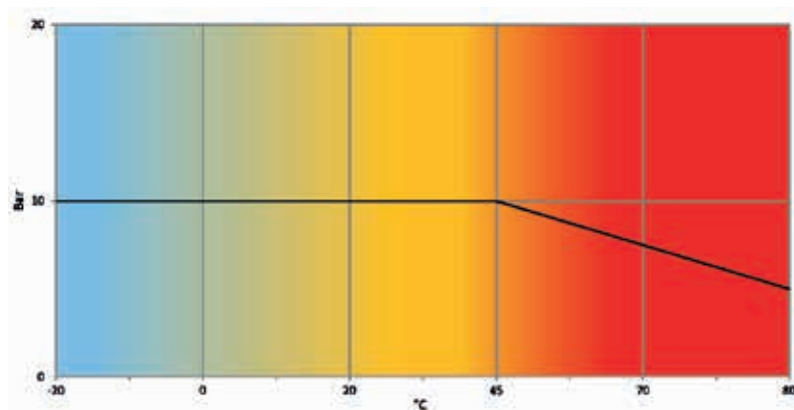

ACTUATOR FEATURES

Power supply voltage	230V 50-60Hz
Absorbed power	46 VA
Input signal	2 Points / SPST / On-Off / with internal relay
Assembly	Quick Mounting
Working time	12 Sec
Weight	0,3 Kg
Motor type	Bidirectional

Working angle	90°
Protection	IP54
Operating temperature	-20 / +70 °C
Connection	Wires Cable 5 Wires
Additional aux contact	250V 0.5A (AC1)
Kvs 3/4 2-way	41
Kvs 1" 2-way	70

ELECTRICAL CONNECTIONS

SM700

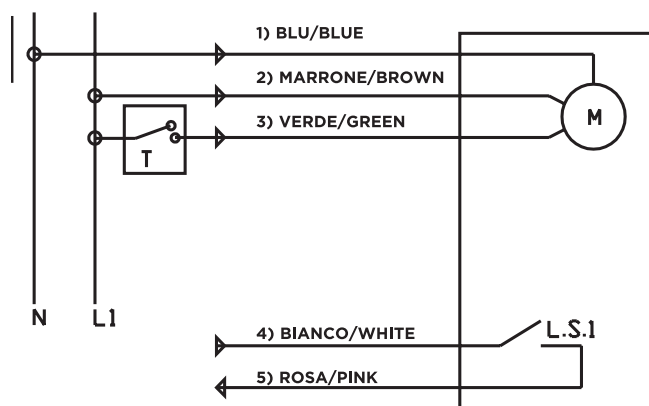

- 1 BLUE** - neutral 230V 50/60Hz
2 BROWN - live 230V 50/60Hz
3 GREEN - live to open / disconnected to close
4 WHITE - common aux. contact
5 PINK - n.o. aux. contact

- N** - neutral (sn)
L1 - live (sp)
T - thermostat (relay)
L.S.1 - aux. contact

WIRE COLOR	DIRECTION	FUNCTION	DESCRIPTION	CONNECTION
Blue	In	Power supply	Neutral (sn)	Connection to neutral
Brown	In	Power supply	Live (sp)	Connection to phase
Green	In	Thermostat (relay)	Open-closed (y1)	When phase connected valve opens; when not phase connected valve closes
White/Pink	Out	Auxiliary output	Clean contact	When valve is open, the two wires are shorted

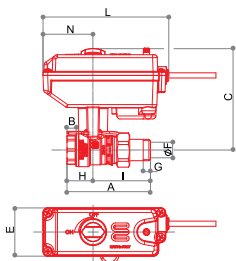

VZ 700
Zone valve F-M with compact electric actuator.

CODE	SIZE	A	B	C	E	F	G	H	I	L	N			
68812700	G 3/4	91	11	102	46.5	20	12	29	62	121	48	1250	1	-
68813400	G 1"	104.5	12.5	106	46.5	25	12	35	69.5	121	48	1430	1	-

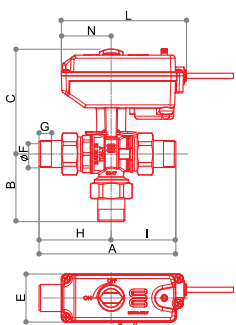

VZ 702
Zone valve M-M-M with compact electric actuator.

CODE	SIZE	A	B	C	D	E	F	H	I	L	N			
68822700	G 3/4	132.5	65.5	102	165.5	46.5	20	62.5	70	121	48	1480	1	-
68823400	G 1"	151	70	106	175	46.5	25	70	81	121	48	1950	1	-

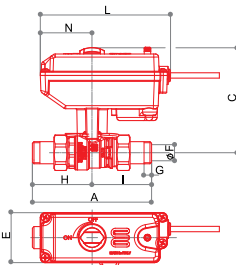

VZ 704
Zone valve M-M with compact electric actuator.

CODE	SIZE	A	B	C	E	F	G	H	I	L	N			
68842700	G 3/4	130	-	102	46.5	20	12	68	62	121	48	1155	1	-
68843400	G 1"	147	-	106	46.5	25	12	77.5	69.5	121	48	1414	1	-

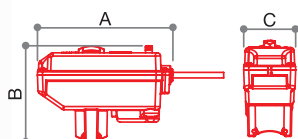

SM 700
Electric actuator for zone valves VZ 700, VZ 702 and VZ 704.

CODE	SIZE	A	B	C	D	E			
69011720	230 V - ON/OFF	121	86	46.5	-	-	480	1	-

DEMAX

MAGNETIC DIRT SEPARATOR FOR HEATING SYSTEM







Energy-saving issues as well as the rational use of resources are very current topics; therefore it is necessary to keep the heating circuit efficient by using a magnetic dirt separator filter placed on the return pipe to capture the impurities present in the heat carrier fluid and avoid any damage they could cause to the heating system.

This device must be installed on the heating circuit, and once positioned, it is necessary to fill the heating system up again, emptying the air in excess.

The main technical data are:

- It prevents the risk of obstruction of the heating circuit pipes and its components.
- Should the boiler be replaced, the dirt separator filter can be mounted on the new one.

TECHNICAL DATA

			
Max temperature	Room temperature	Water working pressure	Maximum water pressure
65 °C	+5°C ...+ 50°C	1,0 ÷ 2,0 bar	3,0 bar

Water content in the heating circuit: ~ 0,2 l

Magnet: Ø12x60 mm, 4500 gauss

Width: 101,5 mm

Height: 116,5 mm

Net weight: 175 g

Fittings supplied: G3/4

OPERATING SCHEME

The dirt separator filter can be installed in two different ways (horizontally or vertically) in order to be suitable to the majority of the domestic hydraulic circuits already existing as well as the new ones.

- 1) Heating system return circuit / dirt separator filter inlet
- 2) Dirt separator filter outlet / towards the boiler
- 3) Position of G 3/4 brass female end cap
- 4) Position of M12 grey plastic end cap for filter's emptying.

Installation with the filter placed horizontally

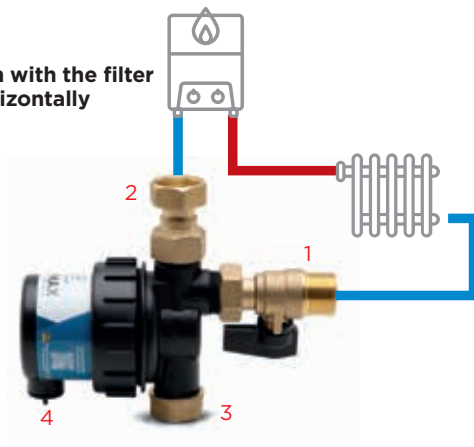

Installation with the filter placed vertically



VALVES

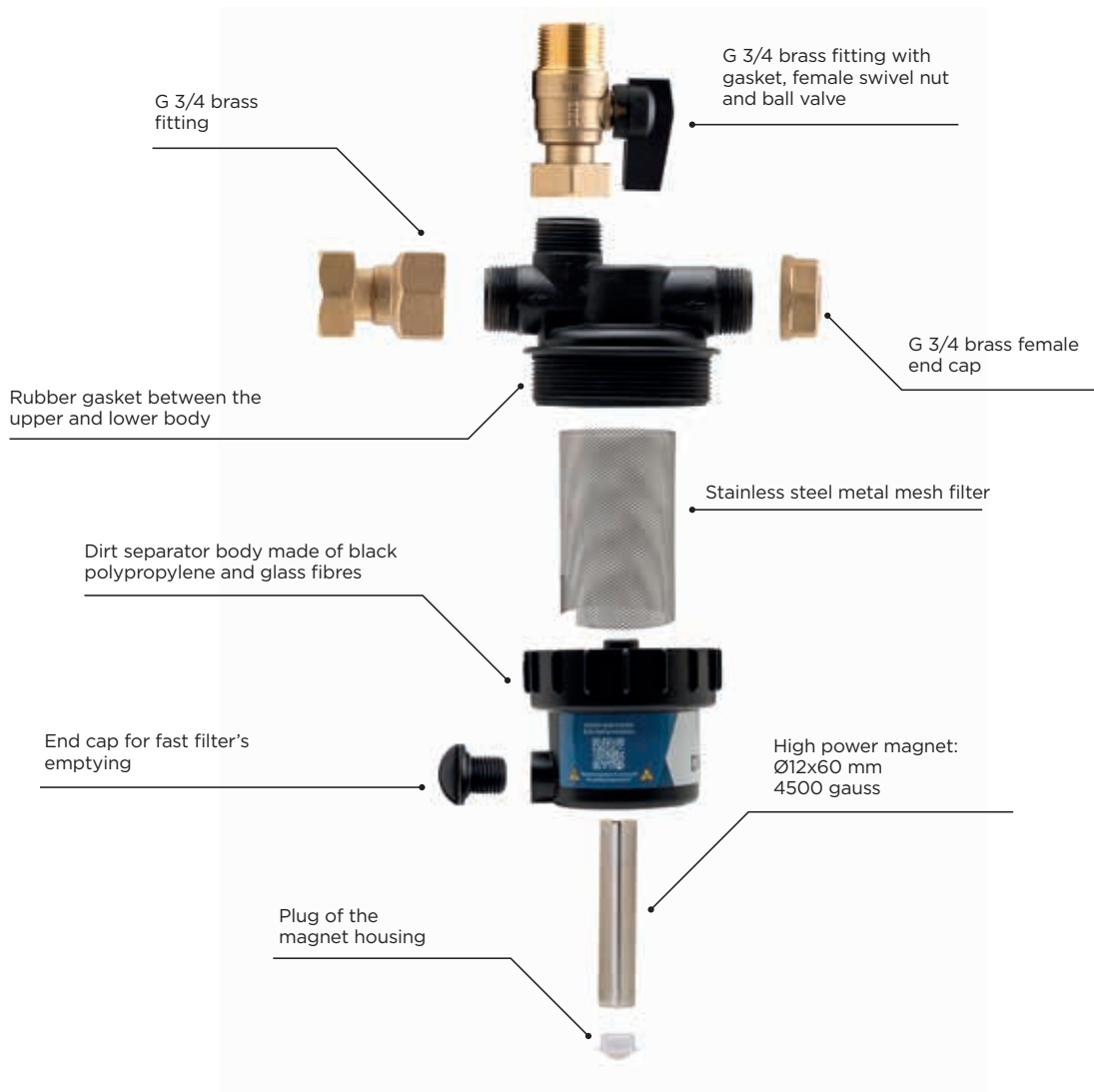

OPERATING PRINCIPLE

The water flow returning from the heating system passes through the inlet fitting of the dirt separator filter, then it flows through the internal area where there is the magnet and the stainless steel metal mesh and goes out through the outlet fitting of the dirt separator filter.

MAGNETIC DIRT SEPARATOR FOR HEATING SYSTEM

**DM 2018**

Magnetic dirt separator for heating system.

CODE	SIZE			
68550010	G 3/4	542	1	6

GENERAL CONDITIONS OF SALE

1 PREMISES - 1.1 The present conditions of sale apply to all supplies of Luxor Spa Products (hereafter "Luxor"). Any general conditions, and in particular the conditions of purchase of the Buyer (hereafter "Customer"), unless expressly accepted in writing by Luxor, shall not bind the latter nor exempt the Customer from the application of the present General Conditions (hereafter GSC)

2. ORDERS - 2.1 The Purchase Orders (referred to as 'Orders') are an irrevocable purchase proposal. By placing an Order, customers fully accept the present General Conditions of Sale.

2.2 Orders are considered accepted only after Luxor confirms them in writing. The Order confirmation and/or Invoice issued by Luxor will be considered as confirmation.

2.3 Any changes to the Order requested by the Customer after the sending of the Order Confirmation will only be valid and enforceable after written acceptance by Luxor. Cancellation or modification of Orders without the prior written consent of Luxor, will give Luxor the right to act to obtain reimbursement of the costs incurred, without prejudice to the right to compensation for greater damages.

3 PRICES - 3.1 Luxor products will be invoiced based on the current price list at the time the order is accepted. Prices do not include VAT or any other taxes.

3.2 Prices listed in sales catalogues/lists are merely indicative and may be subject to change due to production cost increases. In such cases, Luxor will inform the purchaser of the price increase and provide the reasons.

4 DELIVERY TERMS - 4.1 The supplies in each individual Order will be delivered within the stated terms in the Order Confirmation.

4.2 Luxor will not be held responsible for delays in delivery that are not caused by Luxor, such as delays by third parties, including suppliers and sub-suppliers, shippers, and causes of force majeure that result in total or partial inactivity of the plants. In the cases mentioned above, the Customer cannot refuse delivery of the goods, even if it is only partial, nor can they use a delay in delivery as a reason to terminate the contract or claim damages.

5 SHIPMENTS - 5.1 The products will be delivered to the 'Assigned Port' (Incoterms 2020 EXW), with transport costs and risks borne by the buyer, unless otherwise agreed.

5.2 Even in the case of agreed delivery in "Free Port" (Incoterms 2020 DDP) with costs borne by Luxor, the goods will still travel at the buyer's risk. Regardless of the delivery terms agreed upon by the parties, the risks will pass to the buyer at the latest with delivery to the first carrier.

5.3 The transfer of ownership of the goods is suspended until the full price has been paid, but this does not affect the transfer of risk to the purchaser.

5.4 If special packaging is required, an additional charge as indicated in the price list or order confirmation will be added to the invoice.

6 PAYMENTS - 6.1 Payments are due as per the terms and manner specified in the order confirmation and/or invoice.

6.2 Unless otherwise expressly agreed, payments must be made to the bank details mentioned in the sales invoice. For payments made from abroad via bank transfer, the OUR option must be selected to ensure that Luxor receives the net amount on the invoice after deducting bank charges and expenses. Luxor does not authorize any third parties, including agents and representatives, to collect money on its behalf.

6.3 The Customer is not permitted to suspend or delay payments, even in the event of claims or complaints of defects, and must adhere to the agreed terms.

6.4 In case of payment interruption or suspension, the Customer will be considered in default. Luxor reserves the right to charge expenses and interest as per Art. 5 and 6 of D.Lgs n. 192/2012, without prejudice to the right to terminate the contract. Delayed payment may also result in Luxor excluding the guarantee for the entire period of delay.

6.5 If the Customer fails to adhere to the agreed payment terms, or interrupts or suspends payment, Luxor reserves the right to suspend any ongoing supplies and/or make the execution of the current order conditional on the payment of the outstanding debt. Luxor may also withdraw from any further contracts with the Customer and cancel any previously granted favourable conditions, such as discounts or free gifts.

6.6 The Customer is not permitted to offset any claims they may have against Luxor with debts they owe to Luxor, unless formally authorised by Luxor

7 EXPRESS TERMINATION CLAUSE - 7.1 Luxor may terminate the contract immediately if the Customer is undergoing bankruptcy or liquidation proceedings, as well as in the event that the Customer is subject to execution proceedings and/or protests and the economic conditions suggest the purchaser is insolvent.

8 WARRANTY - 8.1 Luxor guarantees the conformity of the products supplied, free from defects that could make them unsuitable for their intended use. The guarantee may be invoked if the defect is due to

manufacturing errors or defects in raw materials that are the responsibility of Luxor.

8.2 Unless otherwise expressly agreed, the guarantee lasts for one (1) year from the date of delivery. The Customer must make a written complaint within eight (8) days from delivery in the case of apparent defects, or, in the case of hidden defects, from the time of discovery and in any event not later than twelve (12) months from delivery.

8.3 In the event of non-conforming products, Luxor may, at its discretion, provide the Buyer with replacement products of the same type and quantity free of charge ex works, after verifying the returned products. Any return must always be previously agreed and authorised by Luxor. The goods in question must be returned 'carriage paid' along with a note explaining the reason for the return within 30 days of Luxor's approval. Failure to do so will result in the authorization becoming invalid.

8.4 If Luxor does not recognize the defective products upon verification, it will invoice those sent as replacements. If Luxor does not recognize the defective products upon verification, they will invoice the replacements. If Luxor is unable to replace defective products, they may issue a credit note to the customer for the value of the defective products. This does not imply any responsibility on Luxor for direct, indirect, or consequential damages resulting from or connected to the defects or faults of the products.

8.5 It is important to note that this guarantee does not cover instances where the product has been installed, used or maintained in a manner that is contrary to the instructions and warnings provided in the installation, use, and maintenance manuals that were included with the product. Additionally, any installation or repair work should only be carried out by qualified personnel.

8.6 The guarantee will not apply if the Purchaser breaches their contractual obligations.

8.7 This warranty is the only warranty and replaces any other written, oral or implied warranties. By accepting these General Terms and Conditions, the Purchaser expressly waives any right of recourse arising from the sale and/or installation of the Products to a non-professional consumer.

9. RESERVATION OF PROPERTY 9.1 The sale of Luxor S.p. A's Products is carried out under reservation of ownership. Therefore the products will remain the property of Luxor S.p.A. until the full payment of the price by the buyer.

10 TRANSFER OF THE CONTRACT 10.1 It is forbidden to transfer the Contract and/or any interest, right and obligation connected to it to third parties without specific written approval by Luxor.

11 PRIVACY - 11.1 The Customer confirms that they have read the information regarding the processing of their personal data, as required by Articles 13 and 14 of Regulation (EU) 2016/679 (GDPR) as amended. The information can be found at <https://luxor.it/privacy-policy>. By accepting these GTC, the Customer consents to the processing of their personal data.

11.2 Luxor will process the personal data provided by the Customer, including through external parties, to fulfil legal obligations and carry out administrative and commercial tasks related to the contractual relationship.

12 APPLICABLE LAW AND COURT OF JURISDICTION - 12.1 Contract is governed by Italian law. Anything not expressly governed by these GVCs shall be governed by the rules on sale provided for in articles 1470 et seq. of the Italian Civil Code.

12.2 The Parties expressly exclude the application of the Vienna Convention on Contracts for the International Sale of Goods. Any disputes related to the Contract, including those regarding its validity, interpretation, execution, and termination, must be referred exclusively to the Court of Brescia.

12.3 Luxor reserves the right to take legal action at the competent court of the Customer's location to recover any outstanding debts. The local law will apply in this case.

13 FINAL CLAUSES - 13.1 The possible nullity and/or ineffectiveness of one or more provisions of these GTC shall not affect the validity of the Contract as a whole.

13.2 Any amendment to the Contract shall be valid only if made in writing and signed by authorised representatives of both Parties.

The customer acknowledges that they are not a 'consumer' and therefore the provisions of law relating to relations between entrepreneurs and consumers do not apply. The customer declares that they have paid particular attention to the following clauses: Introduction (1.1), Orders (2.1-2.3), Prices (3.2), Delivery Terms (4.1-4.2), Shipping (5.1-5.3), and 6. The following sections require approval: Payments (6.2 - 6.3 - 6.4 - 6.5 - 6.6); 7 Express Termination Clause (7.1); 8 Warranty (8.1 - 8.2 - 8.3 - 8.4 - 8.5 - 8.6 - 8.7); 9. Retention of Title (9.1); 10. Applicable Law and Jurisdiction (12.1 - 12.2 - 12.3); 13 Final Clauses (13.1 - 13.2), and they are to be specifically approved.

These general terms and conditions are published on LUXOR's website (<https://luxor.it/>) where they may be consulted, thereby taking full and proper cognisance thereof, pursuant to and for the purposes of Articles 1341 and 1342 of the Civil Code.