



60 YEARS OF ITALIAN TRADITION

Luxor is an important industrial reality, world wide and European market leader in the production of flexible hoses and components for hydro and thermo-sanitary installations. Luxor has been the expression of the most prestigious made in Italy and the great Italian high technology mechanical workings tradition for fifty years; a quality certified and recognized by the most prestigious International Certification Institutes all over the world.

Our mission is the complete customer satisfaction through a process of continuous technological research in order to make high quality, reliable products, anticipating the market evolutions by innovative partnership with both customers and suppliers. Luxor mission takes

place in its own Research and Development Centre in which new and advanced technologies are constantly analyzed and researched with continuous investments to offer the most innovative and reliable solutions for the international markets at competitive costs, ensuring strict quality controls on each single piece.

Luxor entirely plans and realizes each product, thanks to its decennial know how. The great production strength, a "slender" innovative and advanced industrial organization together with a modern logistic conception, make Luxor able to satisfy every kind of request, even customized, with fast deliveries all over the world.



Luxor is certified ISO 9001:2015 by DEKRA Group certification body

CERTIFICATION



Please contact our offices for information about technical specifications and certified products or visit the website of the corresponding certification body for the latter.

Please refer to www.nsf.org for a complete list of NSF approved products.
Please refer to www.iapmort.org for a complete list of UPC/CUPC approved products.



LUXOR®

MODULAR MANIFOLDS WITH FRONT VALVES

2.2 / CV SERIES

CV

MODULAR MANIFOLDS WITH FRONT VALVES



The modular manifolds with front shut-off valves are simply and easily connected to each other. The various utilities are independent from each other thanks to the shut off valves

and can be easily identified using the two silk-screened disks. The CV series manifold allow to adjust and balance each single users. Models with 2 to 4 outlets available.

TECHNICAL DATA

Max temperature	Max working pressure	Max differential pressure	
120 °C	16 bar	1 bar	
Body materials	Shutter materials	Gaskets material	
CB753S UNI EN 1982:2017	CW614N DW UNI EN 12164:2016	EPDM peroxide	
Stem o-ring material	Knob	Testing	Finishing
NBR	Nylon PA6 RAL 9016	100%	Chrome

SYSTEM CONNECTIONS

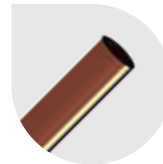

Copper pipe
W 24x19 - TR 91
G 3/4 EK - TR 91/A



Plastic pipe
W 24x19 - TP 95
G 3/4 EK - TP 98



Multilayer pipe
W 24x19 - TP 97
G 3/4 EK - TP 99

MAIN BODY CONNECTION

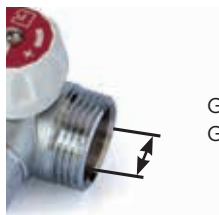

G 3/4
G 1"

CENTRE TO CENTRE DISTANCE



45 mm

The characteristics of the fluid in the system must be compliant with the UNI 8065: 2019 directive.

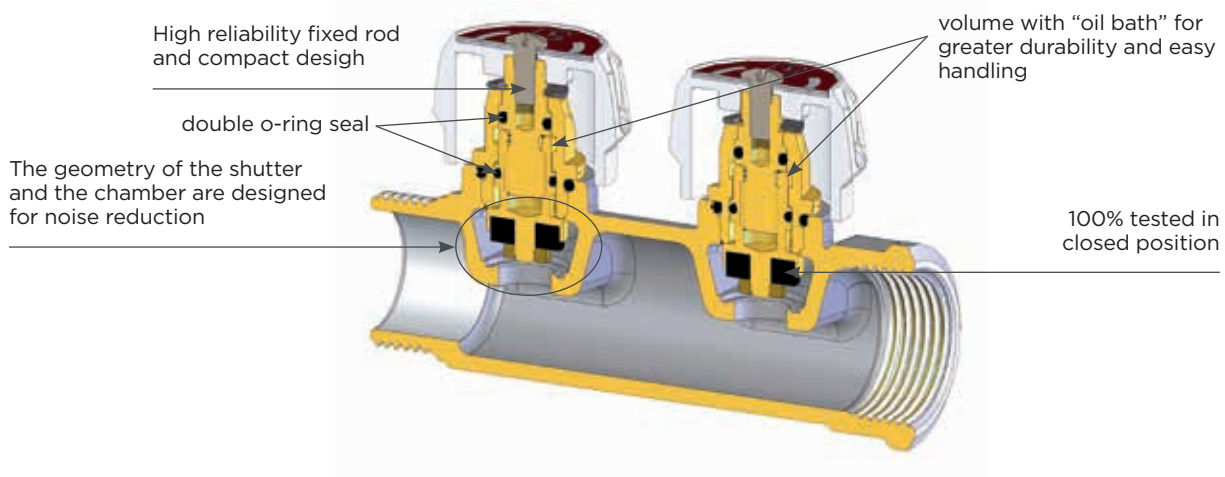

OPERATING INSTRUCTIONS



It is possible to use the aluminium discs supplied with the manifolds to identify the utilities.

For correct assembly of the utilities disks, choose whether to leave the blue side or the red side of the disc visible. The plate is equipped with a window from which it is possible to read the user being served by the manifold. Place the silk-screened metal disc before the red or blue plate so that the name of the delivery terminal is visible from the window, as shown in the image.

Once the indicator has been positioned, fix the metal plate to the knob with the screw on the knob itself.

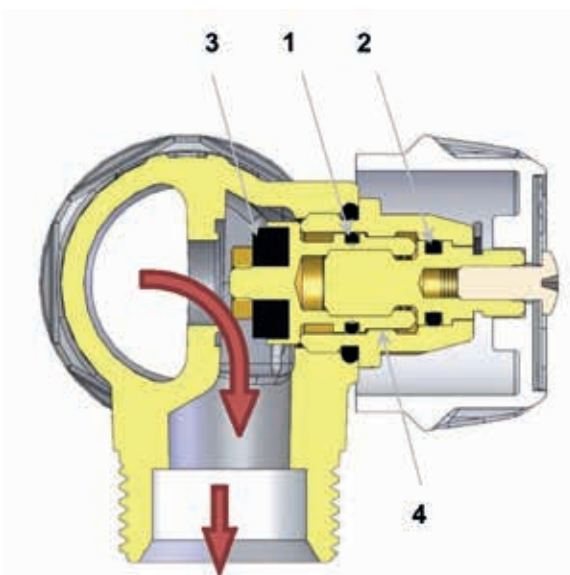

The modular manifold with front shut-off valves must be installed with the inlet water flow as shown in the image on the side.

The manifold headwork is safe and reliable as it has a fixed rod whose seal is guaranteed by two EPDM peroxide o-rings (1-2) while the sealing, when closed with the obturator, is guaranteed by a flat gasket in NBR (3).

A sealed chamber (4) is created inside the valve where lubricating grease is deposited. In this way, the smooth opening and closing movement is guaranteed over time.

The construction of the screw allows the adjustment and balancing of each single user (outlet)

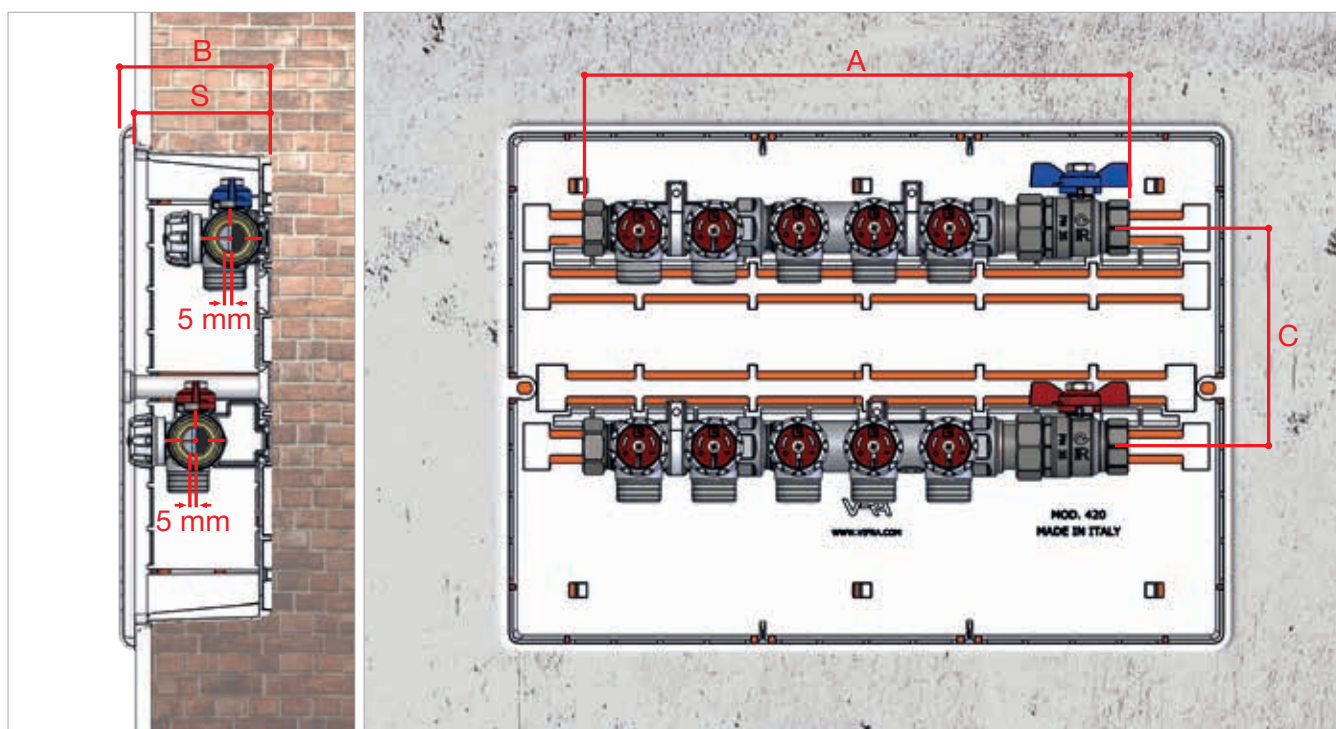

The chart below shows the overall dimensions for the combination of two modular manifolds and a full-flow ball valve.

With these sizes, considering to allow 50 mm free space on the side of the ball valve, it is possible to choose the plastic wall cabinet with the fixing structures and brackets whose external sizes are listed below.

		CF 477						CF 479				
OUTLETS N°	Ø	A	B	C	S	CABINETS	WALL CABINETS DIMENSIONS	B	C	S	CABINETS	WALL CABINETS DIMENSIONS
2	G 3/4	190	100	110	86	68560432	272 x 332 x 86	98	140	88	68560332	290 x 330 x 88
3	G 3/4	235	100	110	86	68560432	272 x 332 x 86	98	140	88	68560332	290 x 330 x 88
4	G 3/4	280	100	110	86	68560432	272 x 332 x 86	98	140	88	68560332	290 x 330 x 88
2 + 3	G 3/4	330	100	110	86	68560440	272 x 412 x 86	98	130	88	68560342	310 x 430 x 88
3 + 3	G 3/4	375	100	110	86	68560440	272 x 412 x 86	98	130	88	68560342	310 x 430 x 88
3 + 4	G 3/4	420	100	110	86	68560450	272 x 512 x 86	98	150	88	68560352	330 x 530 x 88
4 + 4	G 3/4	465	100	110	86	68560450	272 x 512 x 86	98	150	88	68560352	330 x 530 x 88
2	G 1"	192	100	110	86	68560432	272 x 332 x 86	98	140	88	68560332	290 x 330 x 88
3	G 1"	238	100	110	86	68560432	272 x 332 x 86	98	140	88	68560332	290 x 330 x 88
4	G 1"	283	100	110	86	68560432	272 x 332 x 86	98	140	88	68560332	290 x 330 x 88
2 + 3	G 1"	337	100	110	86	68560440	272 x 412 x 86	98	130	88	68560342	310 x 430 x 88
3 + 3	G 1"	382	100	110	86	68560440	272 x 412 x 86	98	130	88	68560342	310 x 430 x 88
3 + 4	G 1"	427	100	110	86	68560450	272 x 512 x 86	98	150	88	68560352	330 x 530 x 88
4 + 4	G 1"	472	100	110	86	68560450	272 x 512 x 86	98	150	88	68560352	330 x 530 x 88

**MODULAR MANIFOLDS WITH FRONT VALVES:
CONNECTION FOR COPPER AND PLASTIC PIPE W24X19**

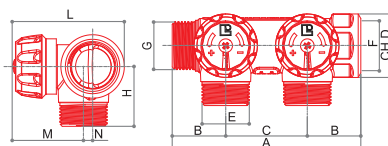

CV 532

2-way modular manifold with shut-off valves. Connection for copper and plastic pipe (W24x19).

Fittings



CODE	SIZE	A	B	C	D	E	F	G	H	L	M	N			
68202702	G 3/4 x (W24x19)	104	29,5	45	32	W24x19	G 3/4	G 3/4	33	61	38,5	5	470	1	45
68203402	G 1" x (W24x19)	108	31,5	45	37	W24x19	G 1"	G 1"	36	63	38,5	5	565	1	45

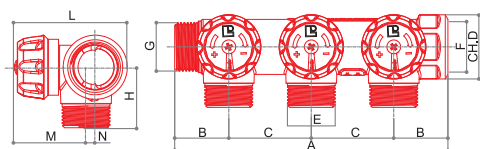

CV 533

3-way modular manifold with shut-off valves. Connection for copper and plastic pipe (W24x19).

Fittings



CODE	SIZE	A	B	C	D	E	F	G	H	L	M	N			
68202703	G 3/4 x (W24x19)	149	29,5	45	32	W24x19	G 3/4	G 3/4	33	61	38,5	5	690	1	34
68203403	G 1" x (W24x19)	153	31,5	45	37	W24x19	G 1"	G 1"	36	63	38,5	5	810	1	34

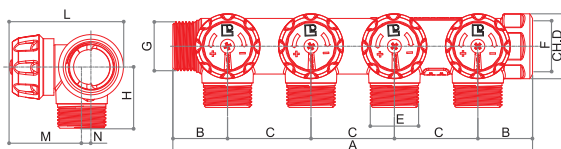

CV 534

4-way modular manifold with shut-off valves. Connection for copper and plastic pipe (W24x19).

Fittings



CODE	SIZE	A	B	C	D	E	F	G	H	L	M	N			
68202704	G 3/4 x (W24x19)	194	29,5	45	32	W24x19	G 3/4	G 3/4	33	61	38,5	5	890	1	25
68203404	G 1" x (W24x19)	198	31,5	45	37	W24x19	G 1"	G 1"	36	63	38,5	5	980	1	25



Raccordi per tubo rame



Raccordi per tubo plastica



Raccordi per tubo multistrato



Raccordi: capitolo 7



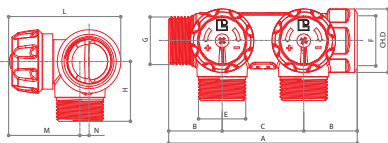

Accessori: capitolo 2.A

**MODULAR MANIFOLDS WITH FRONT VALVES:
COPPER AND PLASTIC PIPE G3/4 EUROKONUS**
**CV 552**

2-way modular manifold
with shut-off valves.
G3/4 Euroconus male
connections.

Fittings



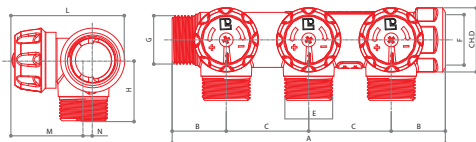

CODE	SIZE	A	B	C	D	E	F	G	H	L	M	N			
68202802	G 3/4 X G 3/4 EK	104	29,5	45	32	G 3/4 EK	G 3/4	G 3/4	33	61	38,5	5	470	1	45
68203502	G 1" X G 3/4 EK	108	31,5	45	37	G 3/4 EK	G 1"	G 1"	36	63	38,5	5	565	1	45

**CV 553**

3-way modular manifold
with shut-off valves.
G3/4 Euroconus male
connections.

Fittings



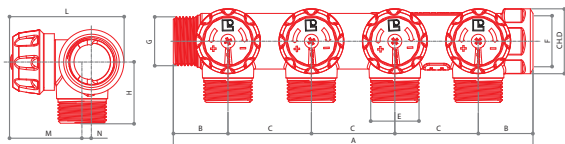

CODE	SIZE	A	B	C	D	E	F	G	H	L	M	N			
68202803	G 3/4 X G 3/4 EK	149	29,5	45	32	G 3/4 EK	G 3/4	G 3/4	33	61	38,5	5	690	1	34
68203503	G 1" X G 3/4 EK	153	31,5	45	37	G 3/4 EK	G 1"	G 1"	36	63	38,5	5	810	1	34

**CV 554**

4-way modular manifold
with shut-off valves. G3/4
Euroconus male connections.

Fittings



CODE	SIZE	A	B	C	D	E	F	G	H	L	M	N			
68202804	G 3/4 X G 3/4 EK	194	29,5	45	32	G 3/4 EK	G 3/4	G 3/4	33	61	38,5	5	890	1	25
68203504	G 1" X G 3/4 EK	198	31,5	45	37	G 3/4 EK	G 1"	G 1"	36	63	38,5	5	980	1	25

REPLACEMENTS



IU 438

Couple of red/blue aluminium discs and indication of utilities for sanitary manifolds for CV series.

CODE	SIZE			
6801617	-	1	-	-



573

ABS manual adjustment knob for CV series manifolds, white coloured (RAL 9016).

CODE	SIZE			
4761632	-	7	-	-



580

Brass screw for manual adjustment knob for Tekna valves.

CODE	SIZE			
9346615	-	1	-	-

MANIFOLDS FLOW RATE CHART

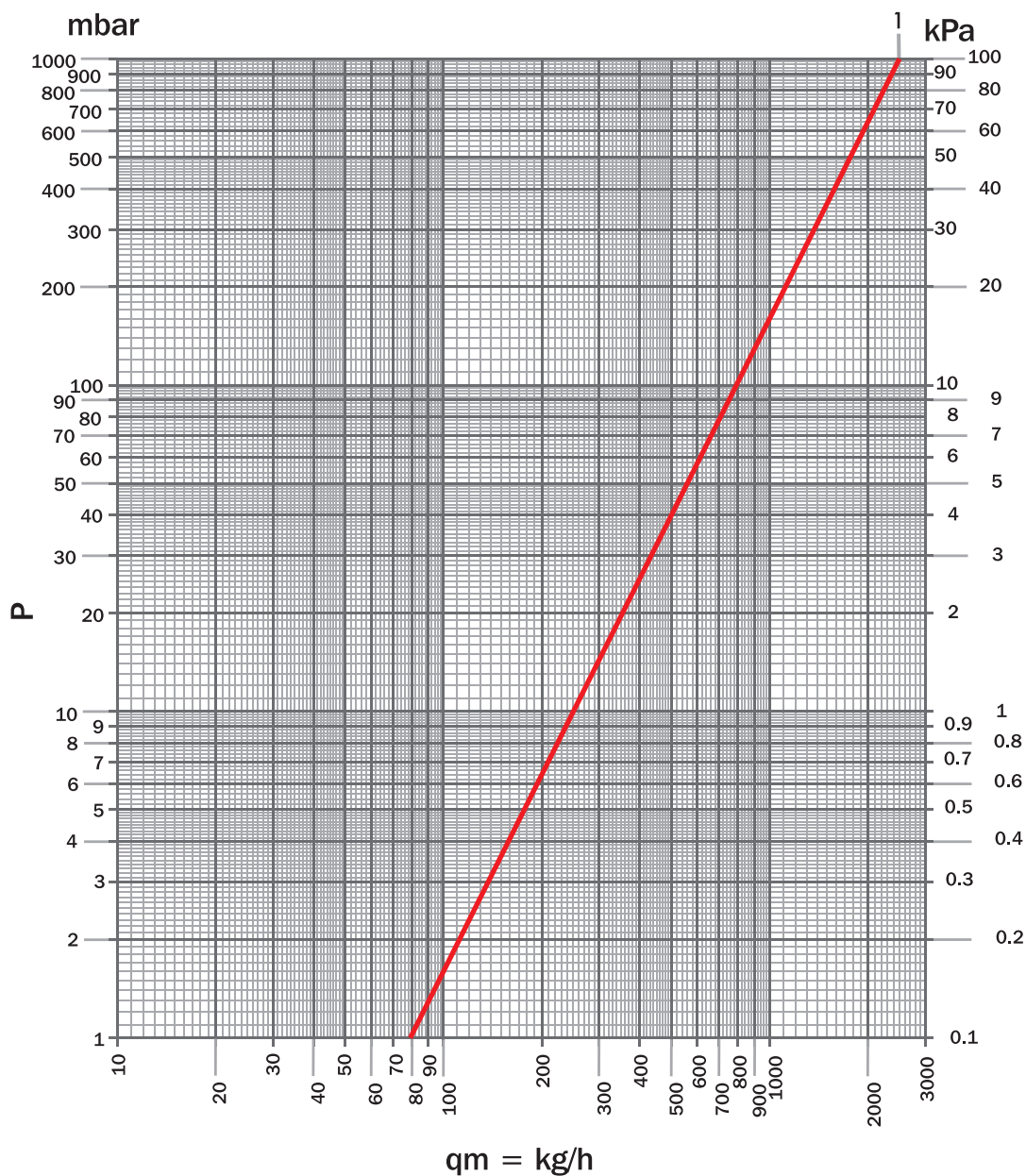

ITEM	SIZE	TURNS N°	Kvs	POS
CV 552 CV 553 CV 554	G 3/4	all open	2,5	1
	G 1"			

GENERAL CONDITIONS OF SALE

1 PREMISES - 1.1 The present conditions of sale apply to all supplies of Luxor Spa Products (hereafter "Luxor"). Any general conditions, and in particular the conditions of purchase of the Buyer (hereafter "Customer"), unless expressly accepted in writing by Luxor, shall not bind the latter nor exempt the Customer from the application of the present General Conditions (hereafter GSC)

2. ORDERS - 2.1 The Purchase Orders (referred to as 'Orders') are an irrevocable purchase proposal. By placing an Order, customers fully accept the present General Conditions of Sale.

2.2 Orders are considered accepted only after Luxor confirms them in writing. The Order confirmation and/or Invoice issued by Luxor will be considered as confirmation.

2.3 Any changes to the Order requested by the Customer after the sending of the Order Confirmation will only be valid and enforceable after written acceptance by Luxor. Cancellation or modification of Orders without the prior written consent of Luxor, will give Luxor the right to act to obtain reimbursement of the costs incurred, without prejudice to the right to compensation for greater damages.

3 PRICES - 3.1 Luxor products will be invoiced based on the current price list at the time the order is accepted. Prices do not include VAT or any other taxes.

3.2 Prices listed in sales catalogues/lists are merely indicative and may be subject to change due to production cost increases. In such cases, Luxor will inform the purchaser of the price increase and provide the reasons.

4 DELIVERY TERMS - 4.1 The supplies in each individual Order will be delivered within the stated terms in the Order Confirmation.

4.2 Luxor will not be held responsible for delays in delivery that are not caused by Luxor, such as delays by third parties, including suppliers and sub-suppliers, shippers, and causes of force majeure that result in total or partial inactivity of the plants. In the cases mentioned above, the Customer cannot refuse delivery of the goods, even if it is only partial, nor can they use a delay in delivery as a reason to terminate the contract or claim damages.

5 SHIPMENTS - 5.1 The products will be delivered to the 'Assigned Port' (Incoterms 2020 EXW), with transport costs and risks borne by the buyer, unless otherwise agreed.

5.2 Even in the case of agreed delivery in "Free Port" (Incoterms 2020 DDP) with costs borne by Luxor, the goods will still travel at the buyer's risk. Regardless of the delivery terms agreed upon by the parties, the risks will pass to the buyer at the latest with delivery to the first carrier.

5.3 The transfer of ownership of the goods is suspended until the full price has been paid, but this does not affect the transfer of risk to the purchaser.

5.4 If special packaging is required, an additional charge as indicated in the price list or order confirmation will be added to the invoice.

6 PAYMENTS - 6.1 Payments are due as per the terms and manner specified in the order confirmation and/or invoice.

6.2 Unless otherwise expressly agreed, payments must be made to the bank details mentioned in the sales invoice. For payments made from abroad via bank transfer, the OUR option must be selected to ensure that Luxor receives the net amount on the invoice after deducting bank charges and expenses. Luxor does not authorize any third parties, including agents and representatives, to collect money on its behalf.

6.3 The Customer is not permitted to suspend or delay payments, even in the event of claims or complaints of defects, and must adhere to the agreed terms.

6.4 In case of payment interruption or suspension, the Customer will be considered in default. Luxor reserves the right to charge expenses and interest as per Art. 5 and 6 of D.Lgs n. 192/2012, without prejudice to the right to terminate the contract. Delayed payment may also result in Luxor excluding the guarantee for the entire period of delay.

6.5 If the Customer fails to adhere to the agreed payment terms, or interrupts or suspends payment, Luxor reserves the right to suspend any ongoing supplies and/or make the execution of the current order conditional on the payment of the outstanding debt. Luxor may also withdraw from any further contracts with the Customer and cancel any previously granted favourable conditions, such as discounts or free gifts.

6.6 The Customer is not permitted to offset any claims they may have against Luxor with debts they owe to Luxor, unless formally authorised by Luxor

7 EXPRESS TERMINATION CLAUSE - 7.1 Luxor may terminate the contract immediately if the Customer is undergoing bankruptcy or liquidation proceedings, as well as in the event that the Customer is subject to execution proceedings and/or protests and the economic conditions suggest the purchaser is insolvent.

8 WARRANTY - 8.1 Luxor guarantees the conformity of the products supplied, free from defects that could make them unsuitable for their intended use. The guarantee may be invoked if the defect is due to

manufacturing errors or defects in raw materials that are the responsibility of Luxor.

8.2 Unless otherwise expressly agreed, the guarantee lasts for one (1) year from the date of delivery. The Customer must make a written complaint within eight (8) days from delivery in the case of apparent defects, or, in the case of hidden defects, from the time of discovery and in any event not later than twelve (12) months from delivery.

8.3 In the event of non-conforming products, Luxor may, at its discretion, provide the Buyer with replacement products of the same type and quantity free of charge ex works, after verifying the returned products. Any return must always be previously agreed and authorised by Luxor. The goods in question must be returned 'carriage paid' along with a note explaining the reason for the return within 30 days of Luxor's approval. Failure to do so will result in the authorization becoming invalid.

8.4 If Luxor does not recognize the defective products upon verification, it will invoice those sent as replacements. If Luxor does not recognize the defective products upon verification, they will invoice the replacements. If Luxor is unable to replace defective products, they may issue a credit note to the customer for the value of the defective products. This does not imply any responsibility on Luxor for direct, indirect, or consequential damages resulting from or connected to the defects or faults of the products.

8.5 It is important to note that this guarantee does not cover instances where the product has been installed, used or maintained in a manner that is contrary to the instructions and warnings provided in the installation, use, and maintenance manuals that were included with the product. Additionally, any installation or repair work should only be carried out by qualified personnel.

8.6 The guarantee will not apply if the Purchaser breaches their contractual obligations.

8.7 This warranty is the only warranty and replaces any other written, oral or implied warranties. By accepting these General Terms and Conditions, the Purchaser expressly waives any right of recourse arising from the sale and/or installation of the Products to a non-professional consumer.

9. RESERVATION OF PROPERTY 9.1 The sale of Luxor S.p. A's Products is carried out under reservation of ownership. Therefore the products will remain the property of Luxor S.p.A. until the full payment of the price by the buyer.

10 TRANSFER OF THE CONTRACT 10.1 It is forbidden to transfer the Contract and/or any interest, right and obligation connected to it to third parties without specific written approval by Luxor.

11 PRIVACY - 11.1 The Customer confirms that they have read the information regarding the processing of their personal data, as required by Articles 13 and 14 of Regulation (EU) 2016/679 (GDPR) as amended. The information can be found at <https://luxor.it/privacy-policy>. By accepting these GTC, the Customer consents to the processing of their personal data.

11.2 Luxor will process the personal data provided by the Customer, including through external parties, to fulfil legal obligations and carry out administrative and commercial tasks related to the contractual relationship.

12 APPLICABLE LAW AND COURT OF JURISDICTION - 12.1 Contract is governed by Italian law. Anything not expressly governed by these GVCs shall be governed by the rules on sale provided for in articles 1470 et seq. of the Italian Civil Code.

12.2 The Parties expressly exclude the application of the Vienna Convention on Contracts for the International Sale of Goods. Any disputes related to the Contract, including those regarding its validity, interpretation, execution, and termination, must be referred exclusively to the Court of Brescia.

12.3 Luxor reserves the right to take legal action at the competent court of the Customer's location to recover any outstanding debts. The local law will apply in this case.

13 FINAL CLAUSES - 13.1 The possible nullity and/or ineffectiveness of one or more provisions of these GTC shall not affect the validity of the Contract as a whole.

13.2 Any amendment to the Contract shall be valid only if made in writing and signed by authorised representatives of both Parties.

The customer acknowledges that they are not a 'consumer' and therefore the provisions of law relating to relations between entrepreneurs and consumers do not apply. The customer declares that they have paid particular attention to the following clauses: Introduction (1.1), Orders (2.1-2.3), Prices (3.2), Delivery Terms (4.1-4.2), Shipping (5.1-5.3), and 6. The following sections require approval: Payments (6.2 - 6.3 - 6.4 - 6.5 - 6.6); 7 Express Termination Clause (7.1); 8 Warranty (8.1 - 8.2 - 8.3 - 8.4 - 8.5 - 8.6 - 8.7); 9. Retention of Title (9.1); 10. Applicable Law and Jurisdiction (12.1 - 12.2 - 12.3); 13 Final Clauses (13.1 - 13.2), and they are to be specifically approved.

These general terms and conditions are published on LUXOR's website (<https://luxor.it/>) where they may be consulted, thereby taking full and proper cognisance thereof, pursuant to and for the purposes of Articles 1341 and 1342 of the Civil Code.